



**THE DATASHEET OF  
ADA4505-2ACBZ-R7**



### FEATURES

- PSRR: 100 dB minimum**
- CMRR: 105 dB typical**
- Very low supply current: 10  $\mu$ A per amplifier maximum**
- 1.8V to 5V single-supply or  $\pm 0.9$ V to  $\pm 2.5$ V dual-supply operation**
- Rail-to-rail input and output**
- 3 mV offset voltage maximum**
- Very low input bias current: 0.5 pA typical**

### APPLICATIONS

- Pressure and position sensors
- Remote security
- Medical monitors
- Battery-powered consumer equipment
- Hazard detectors

### GENERAL DESCRIPTION

The ADA4505-1/ADA4505-2/ADA4505-4 are single, dual, and quad micropower amplifiers featuring rail-to-rail input and output swings while operating from a single 1.8 V to 5 V power supply or from dual  $\pm 0.9$  V to  $\pm 2.5$  V power supplies.

Employing a new circuit technology, these low cost amplifiers offer zero input crossover distortion (excellent PSRR and CMRR performance) and very low bias current, while operating with a supply current of less than 10  $\mu$ A per amplifier.

This combination of features makes the ADA4505-x amplifiers ideal choices for battery-powered applications because they minimize errors due to power supply voltage variations over the lifetime of the battery and maintain high CMRR even for a rail-to-rail op amp.

Remote battery-powered sensors, handheld instrumentation and consumer equipment, hazard detectors (for example, smoke, fire, and gas), and patient monitors can benefit from the features of the ADA4505-x amplifiers.

The ADA4505-x family is specified for both the industrial temperature range ( $-40^{\circ}\text{C}$  to  $+85^{\circ}\text{C}$ ) and the extended industrial temperature range ( $-40^{\circ}\text{C}$  to  $+125^{\circ}\text{C}$ ). The ADA4505-1 single amplifier is available in a tiny 5-lead SOT-23 and a 6-ball WLCSP. The ADA4505-2 dual amplifier is available in a standard 8-lead MSOP and a 8-ball WLCSP. The ADA4505-4 quad amplifier is available in a 14-lead TSSOP and a 14-ball WLCSP.

The ADA4505-x family is a member of a growing series of zero crossover op amps offered by Analog Devices, Inc., including the AD8505/AD8506/AD8508, which also operate from a single 1.8 V to 5 V power supply or from dual  $\pm 0.9$  V to  $\pm 2.5$  V power supplies.

### PIN CONFIGURATIONS

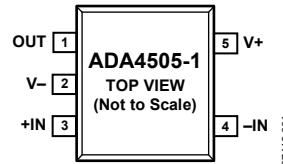

Figure 1. 5-Lead SOT-23 (RJ-5)

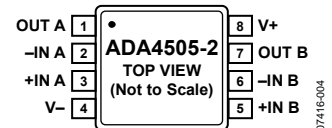

Figure 2. 8-Lead MSOP (RM-8)

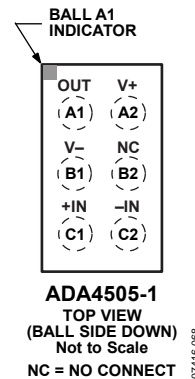

Figure 3. 6-Ball WLCSP (CB-6-7)

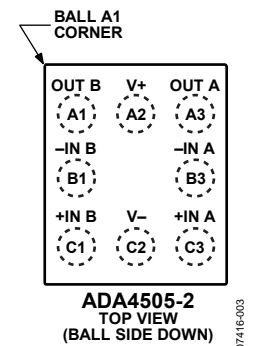

Figure 4. 8-Ball WLCSP (CB-8-2)

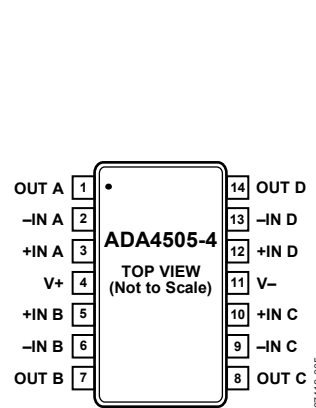

Figure 5. 14-Lead TSSOP (RU-14)

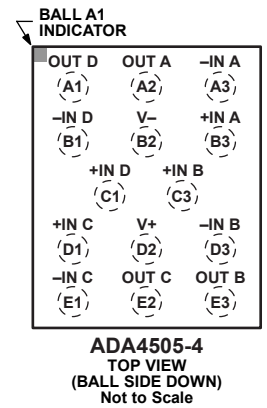

Figure 6. 14-Ball WLCSP (CB-14-1)

**TABLE OF CONTENTS**

Features ..... 1  
 Applications ..... 1  
 General Description ..... 1  
 Pin Configurations ..... 1  
 Revision History ..... 2  
 Specifications ..... 3  
     Electrical Characteristics—1.8 V Operation ..... 3  
     Electrical Characteristics—5 V Operation ..... 4  
 Absolute Maximum Ratings ..... 5  
     Thermal Resistance ..... 5

ESD Caution ..... 5  
 Typical Performance Characteristics ..... 6  
 Theory of Operation ..... 14  
 Applications Information ..... 16  
     Pulse Oximeter Current Source ..... 16  
     Four-Pole, Low-Pass Butterworth Filter for Glucose Monitor ..... 17  
 Outline Dimensions ..... 18  
     Ordering Guide ..... 21

**REVISION HISTORY**

**8/2017—Rev. D to Rev. E**

Updated Outline Dimensions ..... 18

**7/2010—Rev. C to Rev. D**

Added 6-Ball WLCSP, ADA4505-1 ..... Universal  
 Moved Electrical Characteristics—1.8 V Operation Section .... 3  
 Changes to Large Signal Voltage Gain Parameter, Table 1 ..... 3  
 Moved Electrical Characteristics—5 V Operation Section ..... 4  
 Changes to Large Signal Voltage Gain Parameter, Table 2 ..... 4  
 Changes to Thermal Resistance Section and Table 4 ..... 5  
 Updated Outline Dimensions ..... 18  
 Changes to Ordering Guide ..... 21

**7/2009—Rev. B to Rev. C**

Added 5-Lead SOT-23 (ADA4505-1) ..... Throughout  
 Changes to Supply Current per Amplifier Parameter, Table 1 ... 3  
 Changes to Supply Current per Amplifier Parameter, Table 2 ... 4  
 Changes to Figure 26 and Figure 29 ..... 9  
 Changes to Figure 31 and Figure 34 ..... 10  
 Changes to Figure 42 and Figure 45 ..... 12  
 Added Figure 49 and Figure 51; Renumbered Sequentially .... 13  
 Updated Outline Dimensions ..... 18  
 Changes to Ordering Guide ..... 20

**2/2009—Rev. A to Rev. B**

Added 14-Ball WLCSP (ADA4505-4) ..... Throughout  
 Changes to Thermal Resistance Section ..... 5  
 Changes to Figure 17, Figure 18, Figure 20, and Figure 21 ..... 8  
 Changes to Figure 42 and Figure 45 ..... 12  
 Updated Outline Dimensions ..... 18  
 Changes to Ordering Guide ..... 20

**10/2008—Rev. 0 to Rev. A**

Added 8-Ball WLCSP (ADA4505-2) and 14-Lead TSSOP (ADA4505-4) ..... Throughout  
 Change to Features Section ..... 1  
 Added Figure 2 and Figure 3; Renumbered Sequentially ..... 1  
 Changes to Table 1 ..... 3  
 Changes to Table 2 ..... 4  
 Changes to Thermal Resistance Section ..... 5  
 Changes to Figure 22 and Figure 25 ..... 9  
 Changes to Figure 40 and Figure 43 ..... 12  
 Deleted Figure 46 and Figure 48; Renumbered Sequentially ... 13  
 Change to Theory of Operation Section ..... 14  
 Changes to Figure 52 ..... 16  
 Change to Four-Pole Low-Pass Butterworth Filter for Glucose Monitor Section ..... 17  
 Updated Outline Dimensions ..... 18  
 Changes to Ordering Guide ..... 19

**7/2008—Revision 0: Initial Version**

## SPECIFICATIONS

## ELECTRICAL CHARACTERISTICS—1.8 V OPERATION

$V_{SY} = 1.8 \text{ V}$ ,  $V_{CM} = V_{SY}/2$ ,  $T_A = 25^\circ\text{C}$ ,  $R_L = 100 \text{ k}\Omega$  to GND, unless otherwise specified.

Table 1.

Parameter	Symbol	Test Conditions/Comments	Min	Typ	Max	Unit
INPUT CHARACTERISTICS						
Offset Voltage	$V_{OS}$	$0 \text{ V} \leq V_{CM} \leq 1.8 \text{ V}$ $-40^\circ\text{C} \leq T_A \leq +125^\circ\text{C}$		0.5	3	mV
Input Bias Current	$I_B$	$-40^\circ\text{C} \leq T_A \leq +85^\circ\text{C}$ $-40^\circ\text{C} \leq T_A \leq +125^\circ\text{C}$		0.5	2	pA
Input Offset Current	$I_{OS}$	$-40^\circ\text{C} \leq T_A \leq +85^\circ\text{C}$ $-40^\circ\text{C} \leq T_A \leq +125^\circ\text{C}$		0.05	1	pA
Input Voltage Range		$-40^\circ\text{C} \leq T_A \leq +125^\circ\text{C}$	0		1.8	V
Common-Mode Rejection Ratio	CMRR	$0 \text{ V} \leq V_{CM} \leq 1.8 \text{ V}$ $-40^\circ\text{C} \leq T_A \leq +85^\circ\text{C}$ $-40^\circ\text{C} \leq T_A \leq +125^\circ\text{C}$	85	100		dB
Large Signal Voltage Gain	$A_{VO}$	$0.05 \text{ V} \leq V_{OUT} \leq 1.75 \text{ V}$ , $R_L = 100 \text{ k}\Omega$ to $V_{CM}$ $-40^\circ\text{C} \leq T_A \leq +125^\circ\text{C}$	80	115		dB
Offset Voltage Drift	$\Delta V_{OS}/\Delta T$	$-40^\circ\text{C} \leq T_A \leq +125^\circ\text{C}$		2.5		$\mu\text{V}/^\circ\text{C}$
Input Resistance	$R_{IN}$			220		G $\Omega$
Input Capacitance Differential Mode	$C_{INDM}$			2.5		pF
Input Capacitance Common Mode	$C_{INCM}$			4.7		pF
OUTPUT CHARACTERISTICS						
Output Voltage High	$V_{OH}$	$R_L = 100 \text{ k}\Omega$ to GND $-40^\circ\text{C} \leq T_A \leq +125^\circ\text{C}$ $R_L = 10 \text{ k}\Omega$ to GND $-40^\circ\text{C} \leq T_A \leq +125^\circ\text{C}$	1.78 1.78 1.65 1.65	1.79		V V V V
Output Voltage Low	$V_{OL}$	$R_L = 100 \text{ k}\Omega$ to $V_{SY}$ $-40^\circ\text{C} \leq T_A \leq +125^\circ\text{C}$ $R_L = 10 \text{ k}\Omega$ to $V_{SY}$ $-40^\circ\text{C} \leq T_A \leq +125^\circ\text{C}$		2	5	mV mV
Short-Circuit Limit	$I_{SC}$	$V_{OUT} = V_{SY}$ or GND		$\pm 3.8$	25	mV mA
POWER SUPPLY						
Power Supply Rejection Ratio	PSRR	$V_{SY} = 1.8 \text{ V}$ to $5 \text{ V}$ $-40^\circ\text{C} \leq T_A \leq +85^\circ\text{C}$ $-40^\circ\text{C} \leq T_A \leq +125^\circ\text{C}$	100 100 95	110		dB dB dB
Supply Current per Amplifier ADA4505-1	$I_{SY}$	$V_{OUT} = V_{SY}/2$ $-40^\circ\text{C} \leq T_A \leq +125^\circ\text{C}$		10	11.5	$\mu\text{A}$ $\mu\text{A}$
ADA4505-2/ADA4505-4		$-40^\circ\text{C} \leq T_A \leq +125^\circ\text{C}$		7	10	$\mu\text{A}$ $\mu\text{A}$
DYNAMIC PERFORMANCE						
Slew Rate	SR	$R_L = 100 \text{ k}\Omega$ , $C_L = 20 \text{ pF}$ , $G = 1$		6.5		mV/ $\mu\text{s}$
Gain Bandwidth Product	GBP	$R_L = 1 \text{ M}\Omega$ , $C_L = 20 \text{ pF}$ , $G = 1$		50		kHz
Phase Margin	$\Phi_M$	$R_L = 1 \text{ M}\Omega$ , $C_L = 20 \text{ pF}$ , $G = 1$		52		Degrees
NOISE PERFORMANCE						
Voltage Noise	$e_n$ p-p	$f = 0.1 \text{ Hz}$ to $10 \text{ Hz}$		2.95		$\mu\text{V}$ p-p
Voltage Noise Density	$e_n$	$f = 1 \text{ kHz}$		65		nV/ $\sqrt{\text{Hz}}$
Current Noise Density	$i_n$	$f = 1 \text{ kHz}$		20		fA/ $\sqrt{\text{Hz}}$

**ELECTRICAL CHARACTERISTICS—5 V OPERATION**

$V_{SY} = 5\text{ V}$ ,  $V_{CM} = V_{SY}/2$ ,  $T_A = 25^\circ\text{C}$ ,  $R_L = 100\text{ k}\Omega$  to GND, unless otherwise specified.

Table 2.

Parameter	Symbol	Test Conditions/Comments	Min	Typ	Max	Unit
<b>INPUT CHARACTERISTICS</b>						
Offset Voltage	$V_{OS}$	$0\text{ V} \leq V_{CM} \leq 5\text{ V}$ $-40^\circ\text{C} \leq T_A \leq +125^\circ\text{C}$		0.5	3	mV
Input Bias Current	$I_B$	$-40^\circ\text{C} \leq T_A \leq +85^\circ\text{C}$ $-40^\circ\text{C} \leq T_A \leq +125^\circ\text{C}$		0.5	2	pA
					50	pA
Input Offset Current	$I_{OS}$	$-40^\circ\text{C} \leq T_A \leq +85^\circ\text{C}$ $-40^\circ\text{C} \leq T_A \leq +125^\circ\text{C}$		0.05	1	pA
					25	pA
					130	pA
Input Voltage Range		$-40^\circ\text{C} \leq T_A \leq +125^\circ\text{C}$	0		5	V
Common-Mode Rejection Ratio	CMRR	$0\text{ V} \leq V_{CM} \leq 5\text{ V}$ $-40^\circ\text{C} \leq T_A \leq +85^\circ\text{C}$ $-40^\circ\text{C} \leq T_A \leq +125^\circ\text{C}$	90	105		dB
			90			dB
			85			dB
Large Signal Voltage Gain	$A_{VO}$	$0.05\text{ V} \leq V_{OUT} \leq 4.95\text{ V}$ , $R_L = 100\text{ k}\Omega$ to $V_{CM}$ $-40^\circ\text{C} \leq T_A \leq +125^\circ\text{C}$	105	120		dB
			100			dB
Offset Voltage Drift	$\Delta V_{OS}/\Delta T$	$-40^\circ\text{C} \leq T_A \leq +125^\circ\text{C}$		2		$\mu\text{V}/^\circ\text{C}$
Input Resistance	$R_{IN}$			220		G $\Omega$
Input Capacitance Differential Mode	$C_{INDM}$			2.5		pF
Input Capacitance Common Mode	$C_{INCM}$			4.7		pF
<b>OUTPUT CHARACTERISTICS</b>						
Output Voltage High	$V_{OH}$	$R_L = 100\text{ k}\Omega$ to GND $-40^\circ\text{C} \leq T_A \leq +125^\circ\text{C}$	4.98	4.99		V
			4.98			V
			4.9	4.95		V
			4.9			V
Output Voltage Low	$V_{OL}$	$R_L = 100\text{ k}\Omega$ to $V_{SY}$ $-40^\circ\text{C} \leq T_A \leq +125^\circ\text{C}$		2	5	mV
					5	mV
				10	25	mV
					25	mV
Short-Circuit Limit	$I_{SC}$	$V_{OUT} = V_{SY}$ or GND		$\pm 40$		mA
<b>POWER SUPPLY</b>						
Power Supply Rejection Ratio	PSRR	$V_{SY} = 1.8\text{ V}$ to $5\text{ V}$ $-40^\circ\text{C} \leq T_A \leq +85^\circ\text{C}$ $-40^\circ\text{C} \leq T_A \leq +125^\circ\text{C}$	100	110		dB
			100			dB
			95			dB
Supply Current per Amplifier ADA4505-1	$I_{SY}$	$V_{OUT} = V_{SY}/2$ $-40^\circ\text{C} \leq T_A \leq +125^\circ\text{C}$		9	10.5	$\mu\text{A}$
					15	$\mu\text{A}$
				7	10	$\mu\text{A}$
					15	$\mu\text{A}$
Supply Current per Amplifier ADA4505-2/ADA4505-4	$I_{SY}$	$V_{OUT} = V_{SY}/2$ $-40^\circ\text{C} \leq T_A \leq +125^\circ\text{C}$		7	10	$\mu\text{A}$
					15	$\mu\text{A}$
						$\mu\text{A}$
						$\mu\text{A}$
<b>DYNAMIC PERFORMANCE</b>						
Slew Rate	SR	$R_L = 100\text{ k}\Omega$ , $C_L = 20\text{ pF}$ , $G = 1$		6		mV/ $\mu\text{s}$
Gain Bandwidth Product	GBP	$R_L = 1\text{ M}\Omega$ , $C_L = 20\text{ pF}$ , $G = 1$		50		kHz
Phase Margin	$\Phi_M$	$R_L = 1\text{ M}\Omega$ , $C_L = 20\text{ pF}$ , $G = 1$		52		Degrees
<b>NOISE PERFORMANCE</b>						
Voltage Noise	$e_n$ p-p	$f = 0.1\text{ Hz}$ to $10\text{ Hz}$		2.95		$\mu\text{V}$ p-p
Voltage Noise Density	$e_n$	$f = 1\text{ kHz}$		65		nV/ $\sqrt{\text{Hz}}$
Current Noise Density	$i_n$	$f = 1\text{ kHz}$		20		fA/ $\sqrt{\text{Hz}}$

## ABSOLUTE MAXIMUM RATINGS

Table 3.

Parameter	Rating
Supply Voltage	5.5 V
Input Voltage	$\pm V_{SY} \pm 0.1$ V
Input Current <sup>1</sup>	$\pm 10$ mA
Differential Input Voltage <sup>2</sup>	$\pm V_{SY}$
Output Short-Circuit Duration to GND	Indefinite
Storage Temperature Range	-65°C to +150°C
Operating Temperature Range	-40°C to +125°C
Junction Temperature Range	-65°C to +150°C
Lead Temperature (Soldering, 60 sec)	300°C

<sup>1</sup> Input pins have clamp diodes to the supply pins. Limit input current to 10 mA or less whenever the input signal exceeds the power supply rail by 0.1 V.

<sup>2</sup> Differential input voltage is limited to 5 V or the supply voltage, whichever is less.

Stresses at or above those listed under Absolute Maximum Ratings may cause permanent damage to the product. This is a stress rating only; functional operation of the product at these or any other conditions above those indicated in the operational section of this specification is not implied. Operation beyond the maximum operating conditions for extended periods may affect product reliability.

## THERMAL RESISTANCE

$\theta_{JA}$  is specified for the worst-case conditions, that is, a device soldered in a circuit board for surface-mount packages with its exposed paddle soldered to a pad (if applicable). Simulated thermal numbers on a 4-layer (2S/2P) JEDEC standard thermal test board, unless otherwise specified.

Table 4.

Package Type	$\theta_{JA}$	$\theta_{JC}$	Unit
5-Lead SOT-23 (RJ-5)	190	92	°C/W
6-Ball WLCSP (CB-6-7)	105	2.6	°C/W
8-Lead MSOP (RM-8)	142	45	°C/W
8-Ball WLCSP (CB-8-2)	82	N/A	°C/W
14-Lead TSSOP (RU-14)	112	35	°C/W
14-Ball WLCSP (CB-14-1)	64	N/A	°C/W

## ESD CAUTION



**ESD (electrostatic discharge) sensitive device.** Charged devices and circuit boards can discharge without detection. Although this product features patented or proprietary protection circuitry, damage may occur on devices subjected to high energy ESD. Therefore, proper ESD precautions should be taken to avoid performance degradation or loss of functionality.

# TYPICAL PERFORMANCE CHARACTERISTICS

T<sub>A</sub> = 25°C, unless otherwise noted.

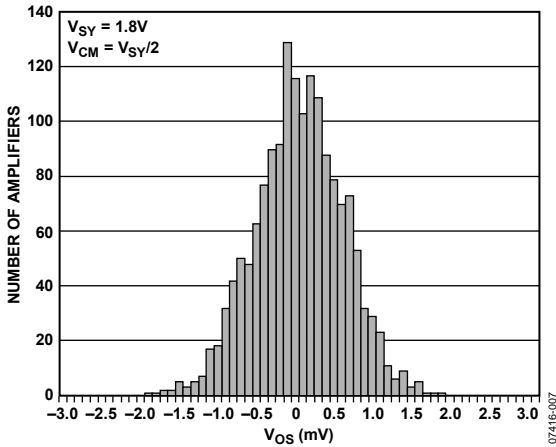

Figure 7. Input Offset Voltage Distribution

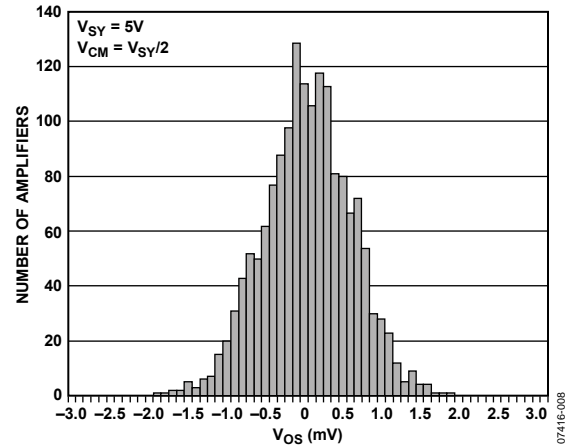

Figure 10. Input Offset Voltage Distribution

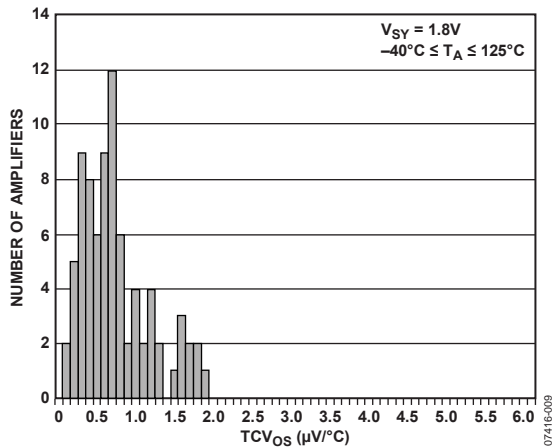

Figure 8. Input Offset Voltage Drift Distribution

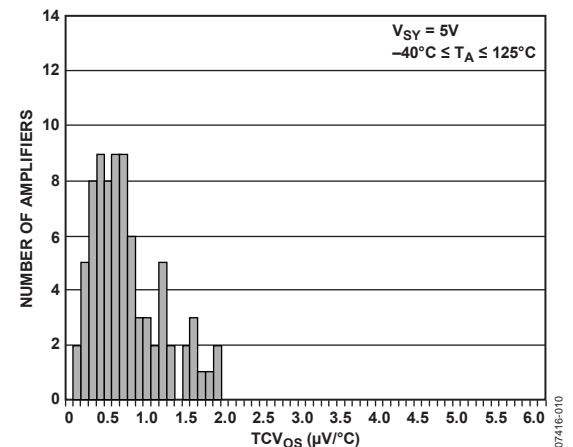

Figure 11. Input Offset Voltage Drift Distribution

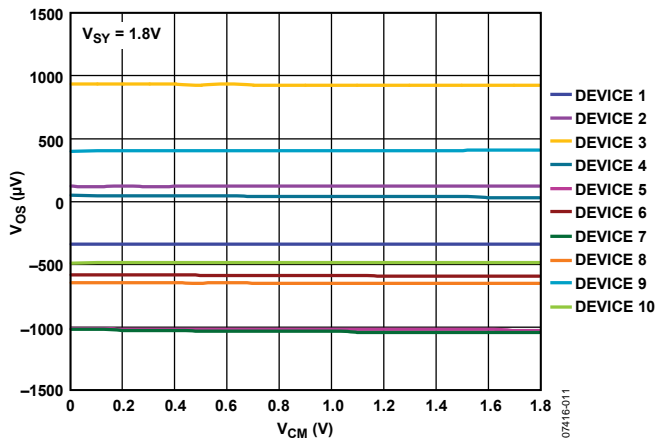

Figure 9. Input Offset Voltage vs. Common-Mode Voltage

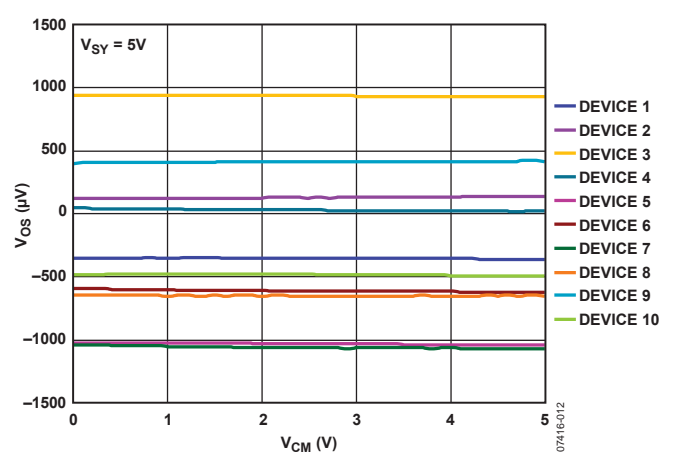

Figure 12. Input Offset Voltage vs. Common-Mode Voltage

T<sub>A</sub> = 25°C, unless otherwise noted.

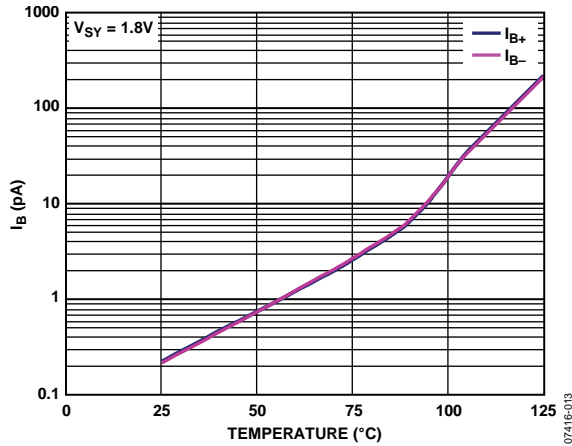

Figure 13. Input Bias Current vs. Temperature

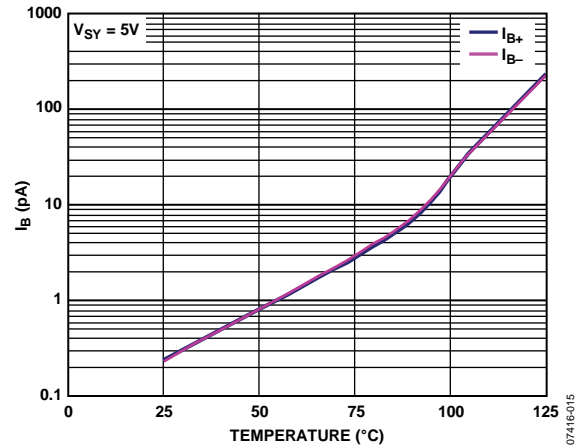

Figure 16. Input Bias Current vs. Temperature

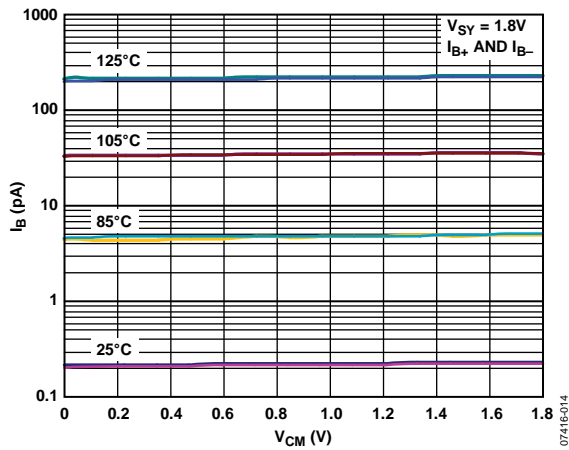

Figure 14. Input Bias Current vs. Common-Mode Voltage and Temperature

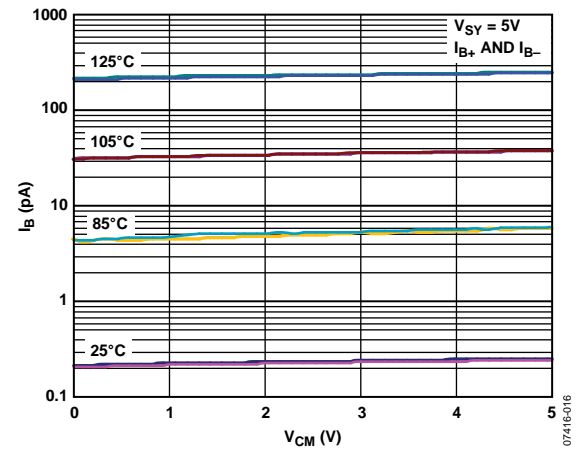

Figure 17. Input Bias Current vs. Common-Mode Voltage and Temperature

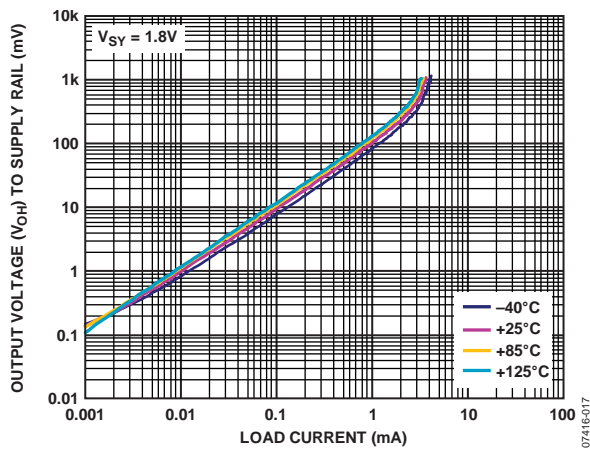

Figure 15. Output Voltage (V<sub>OH</sub>) to Supply Rail vs. Load Current and Temperature

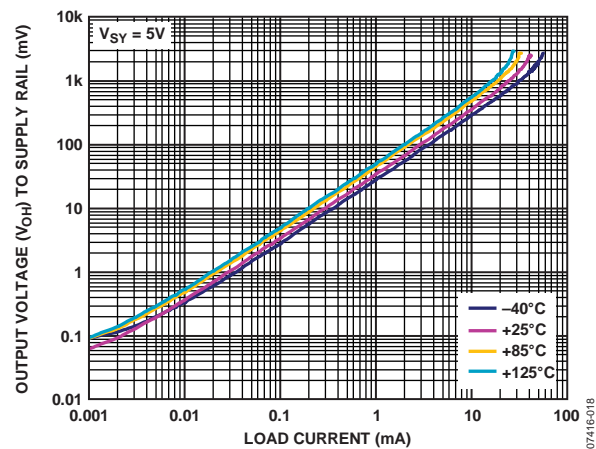

Figure 18. Output Voltage (V<sub>OH</sub>) to Supply Rail vs. Load Current and Temperature

T<sub>A</sub> = 25°C, unless otherwise noted.

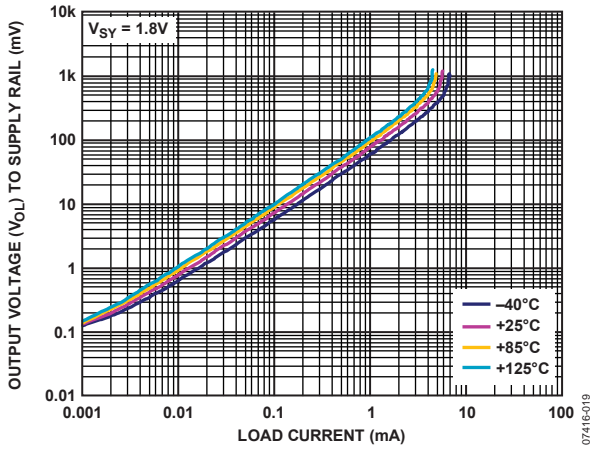

Figure 19. Output Voltage ( $V_{OI}$ ) to Supply Rail vs. Load Current and Temperature

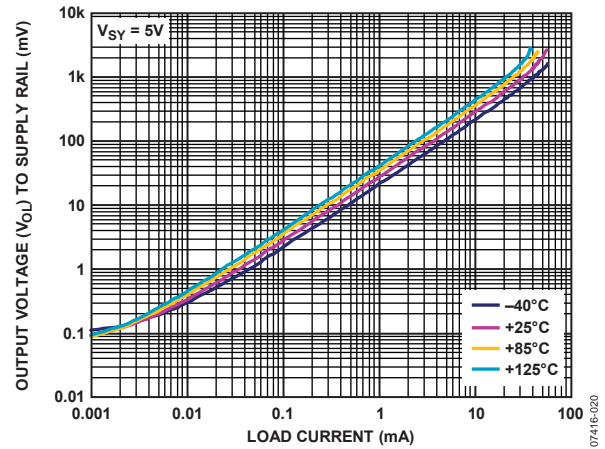

Figure 22. Output Voltage ( $V_{OI}$ ) to Supply Rail vs. Load Current and Temperature

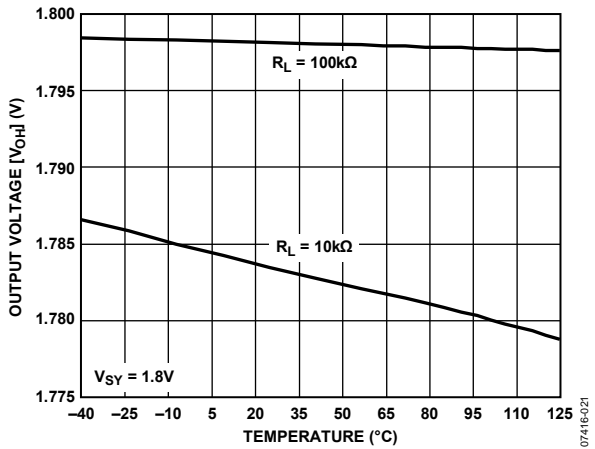

Figure 20. Output Voltage ( $V_{OH}$ ) vs. Temperature

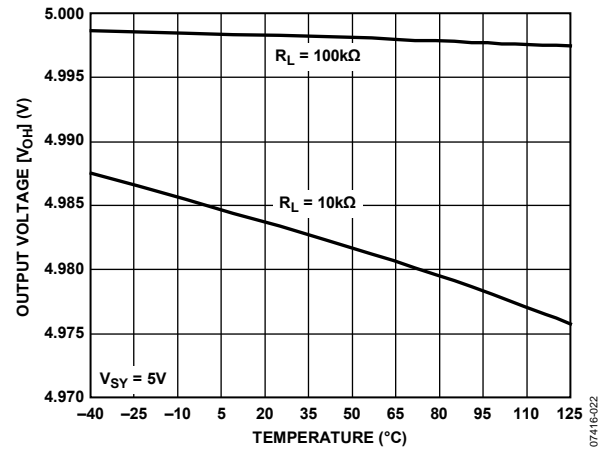

Figure 23. Output Voltage ( $V_{OH}$ ) vs. Temperature

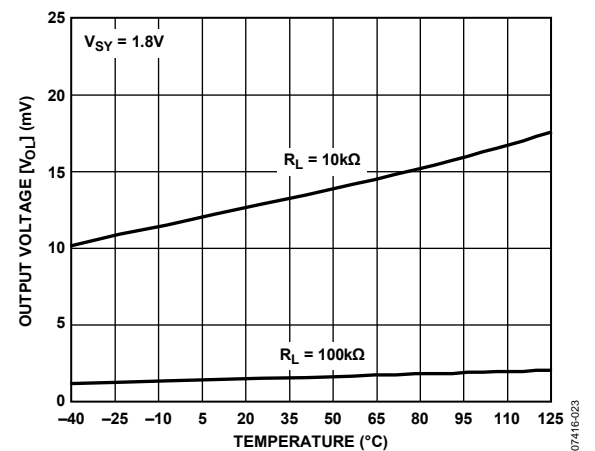

Figure 21. Output Voltage ( $V_{OI}$ ) vs. Temperature

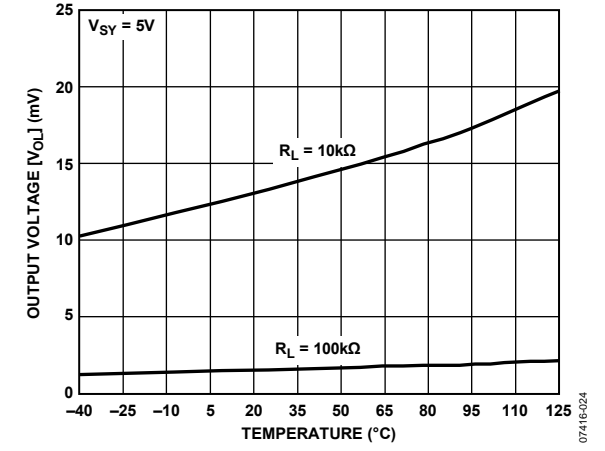

Figure 24. Output Voltage ( $V_{OI}$ ) vs. Temperature

T<sub>A</sub> = 25°C, unless otherwise noted.

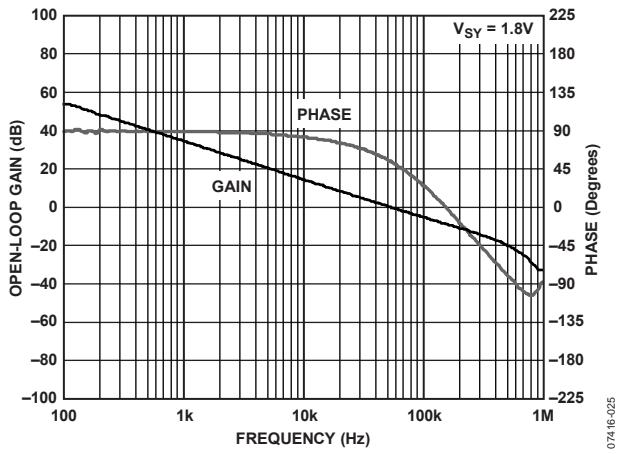

Figure 25. Open-Loop Gain and Phase vs. Frequency

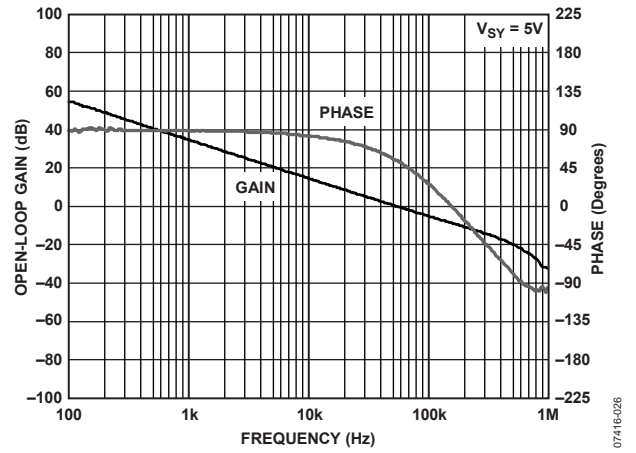

Figure 28. Open-Loop Gain and Phase vs. Frequency

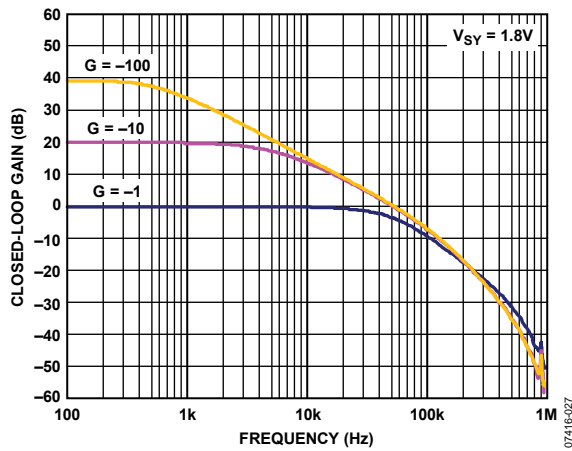

Figure 26. Closed-Loop Gain vs. Frequency

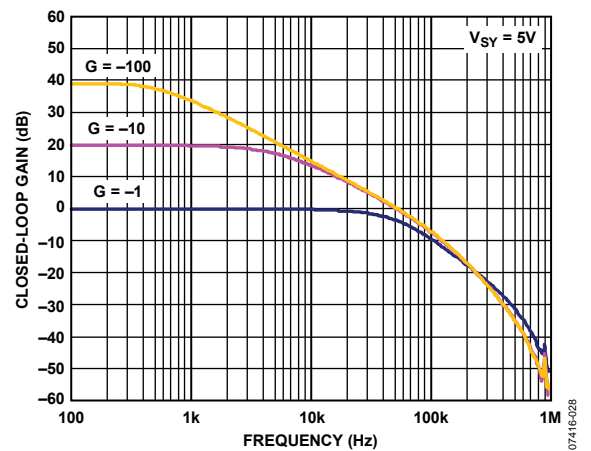

Figure 29. Closed-Loop Gain vs. Frequency

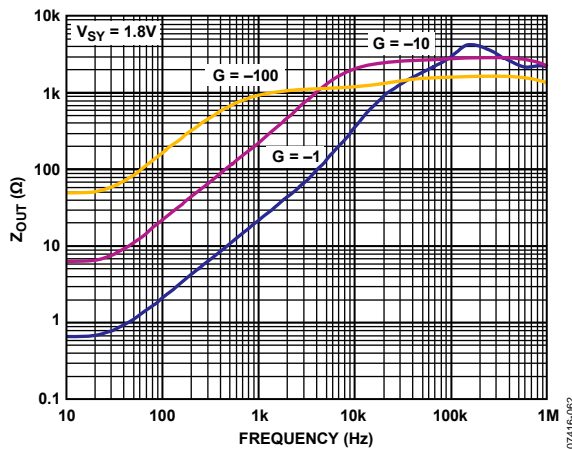

Figure 27. Output Impedance vs. Frequency

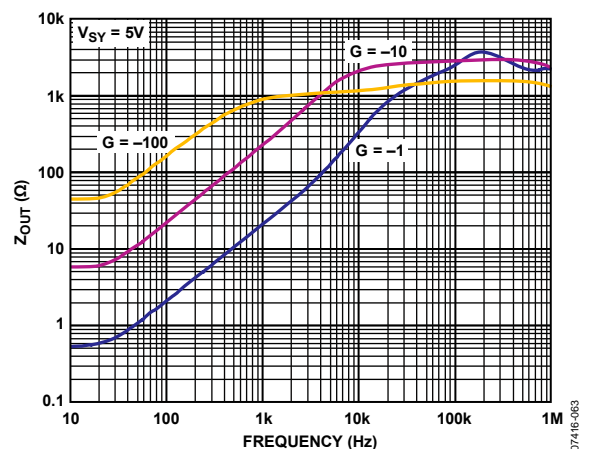

Figure 30. Output Impedance vs. Frequency

T<sub>A</sub> = 25°C, unless otherwise noted.

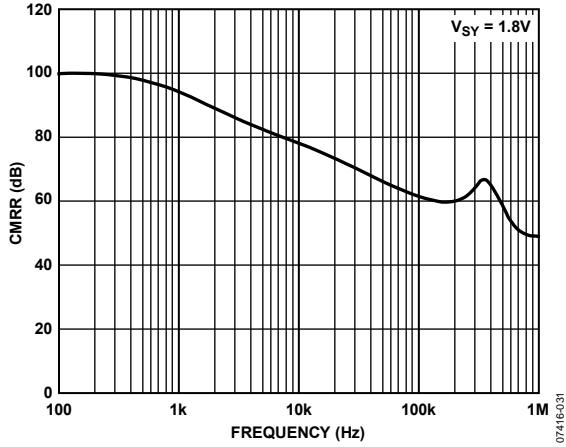

Figure 31. CMRR vs. Frequency

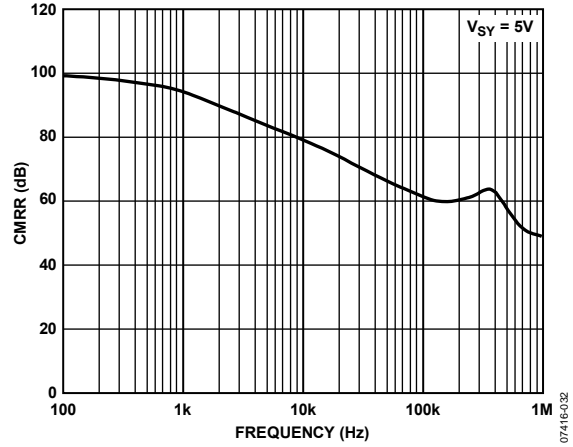

Figure 34. CMRR vs. Frequency

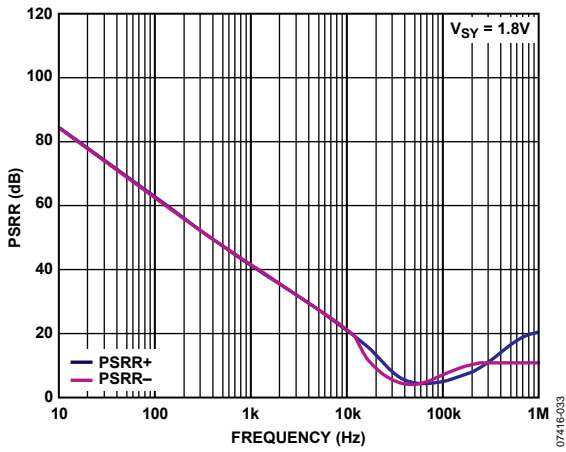

Figure 32. PSRR vs. Frequency

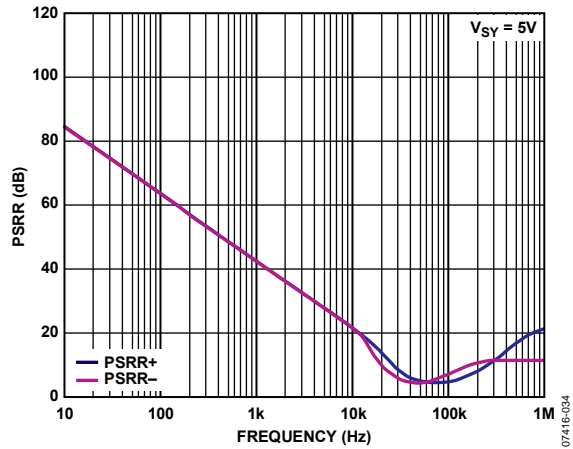

Figure 35. PSRR vs. Frequency

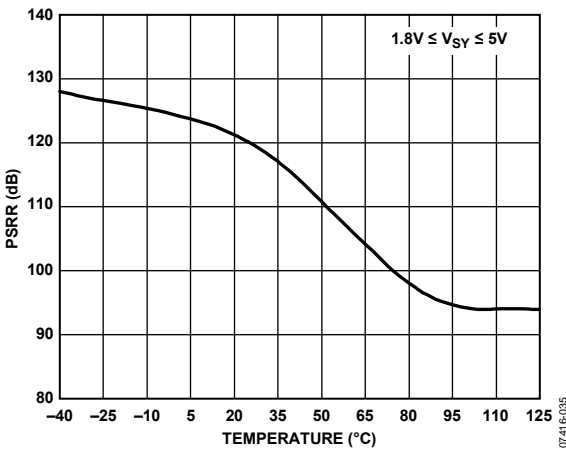

Figure 33. PSRR vs. Temperature

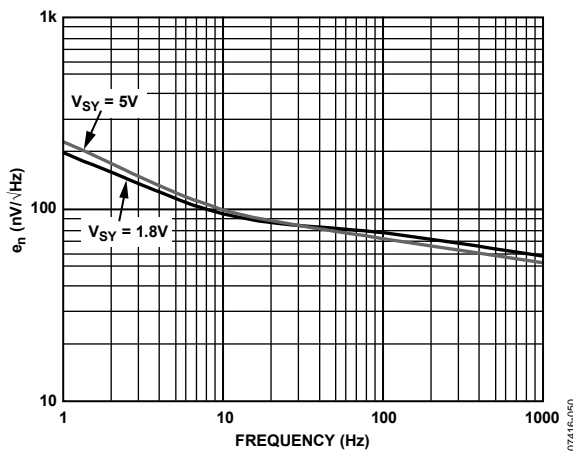

Figure 36. Voltage Noise Density vs. Frequency

T<sub>A</sub> = 25°C, unless otherwise noted.

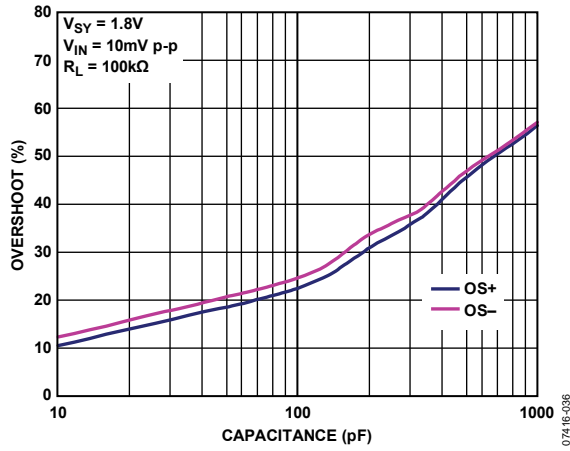

Figure 37. Small Signal Overshoot vs. Load Capacitance

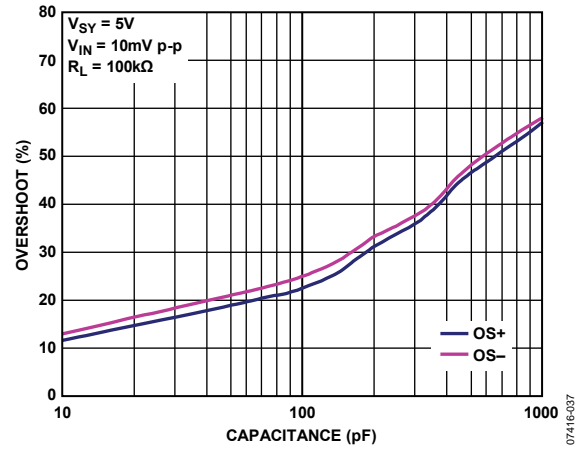

Figure 40. Small Signal Overshoot vs. Load Capacitance

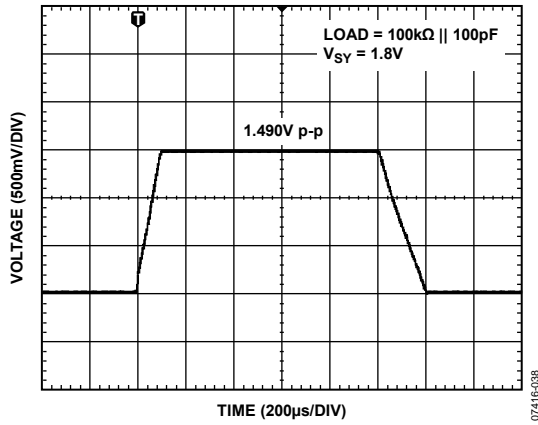

Figure 38. Large Signal Transient Response

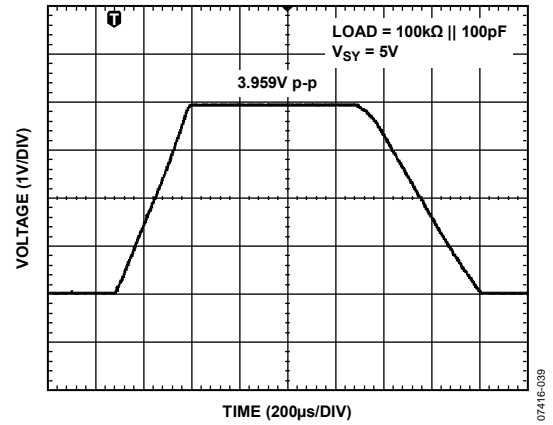

Figure 41. Large Signal Transient Response

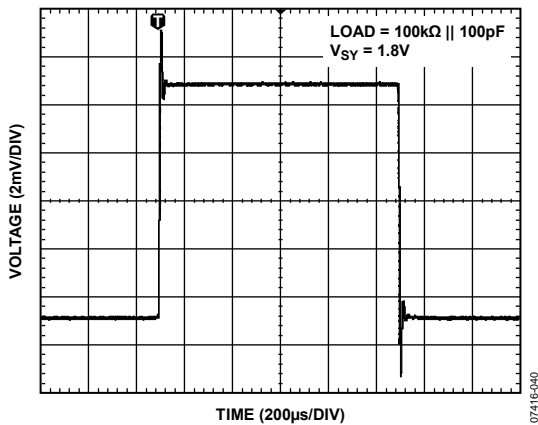

Figure 39. Small Signal Transient Response

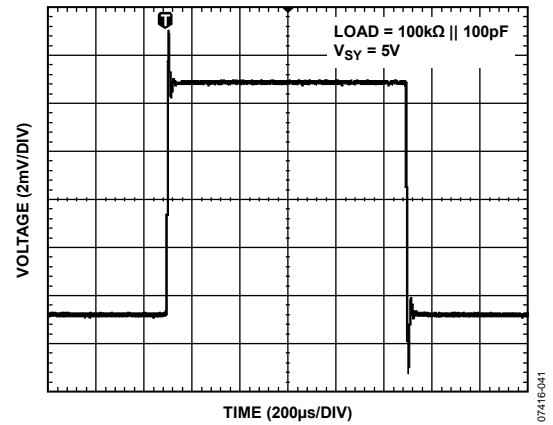

Figure 42. Small Signal Transient Response

T<sub>A</sub> = 25°C, unless otherwise noted.

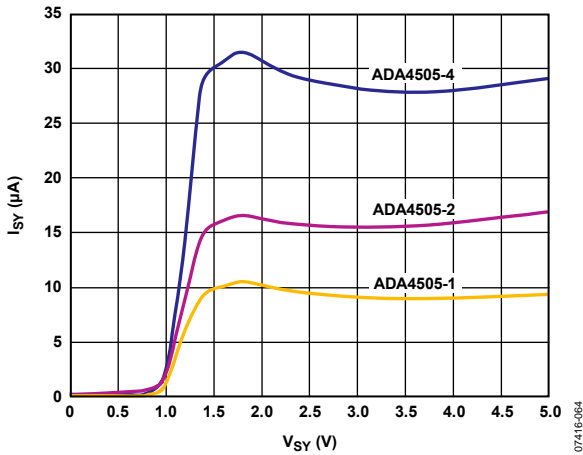

Figure 43. Supply Current vs. Supply Voltage

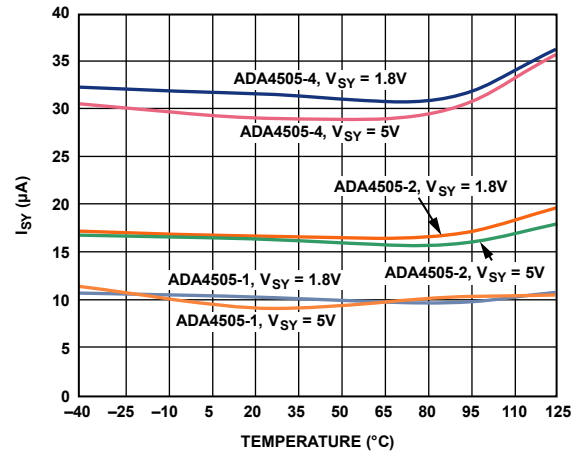

Figure 46. Total Supply Current vs. Temperature

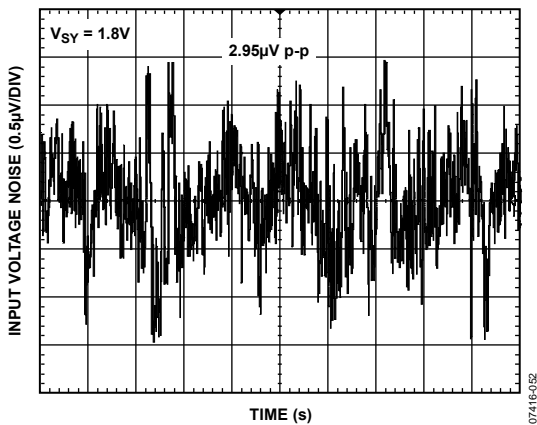

Figure 44. Input Voltage Noise, 0.1 Hz to 10 Hz Noise

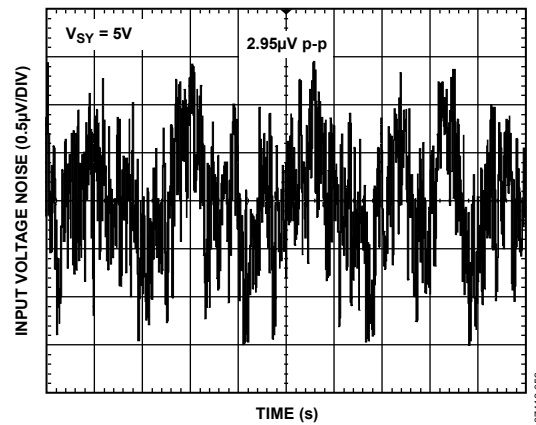

Figure 47. Input Voltage Noise, 0.1 Hz to 10 Hz Noise

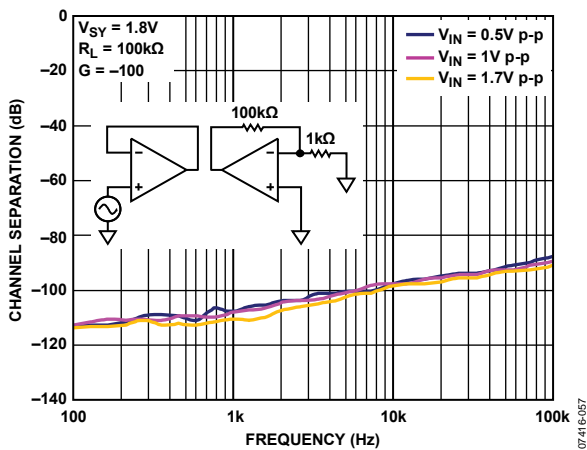

Figure 45. Channel Separation vs. Frequency

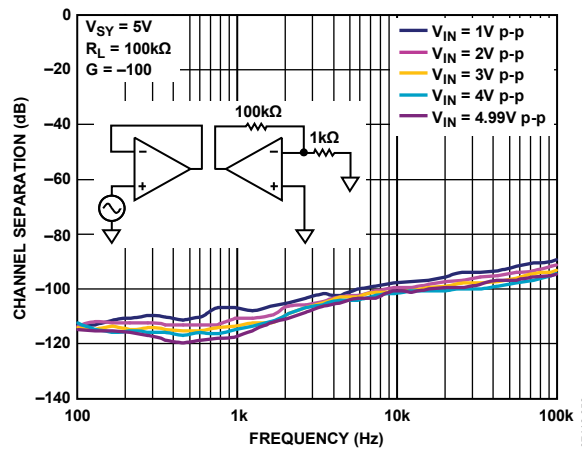

Figure 48. Channel Separation vs. Frequency

T<sub>A</sub> = 25°C, unless otherwise noted.

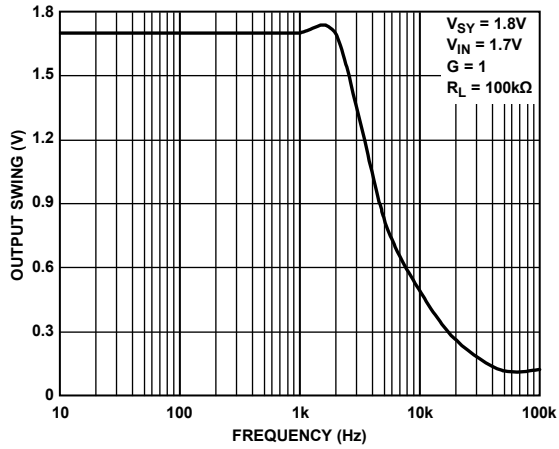

Figure 49. Output Swing vs. Frequency

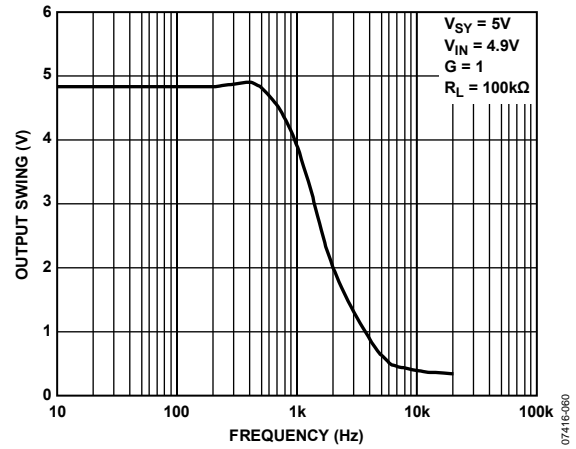

Figure 51. Output Swing vs. Frequency

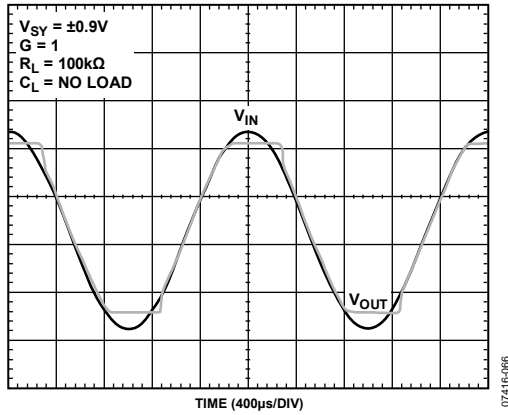

Figure 50. No Phase Reversal

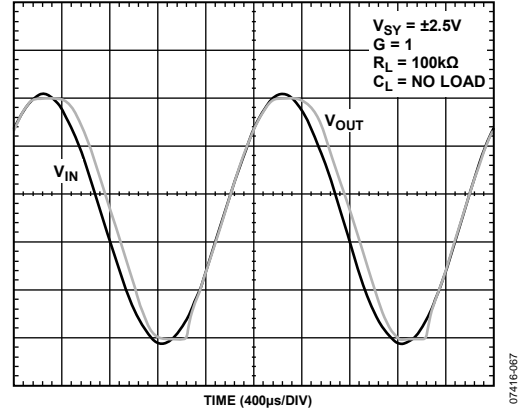

Figure 52. No Phase Reversal

## THEORY OF OPERATION

The ADA4505-1/ADA4505-2/ADA4505-4 are unity-gain stable CMOS rail-to-rail input/output operational amplifiers designed to optimize performance in current consumption, PSRR, CMRR, and zero crossover distortion, all embedded in a small package. The typical offset voltage is 500  $\mu\text{V}$ , with a low peak-to-peak voltage noise of 2.95  $\mu\text{V}$  from 0.1 Hz to 10 Hz and a voltage noise density of 65  $\text{nV}/\sqrt{\text{Hz}}$  at 1 kHz.

The ADA4505-x amplifiers are designed to solve two key problems in low voltage battery-powered applications: battery voltage decrease over time and rail-to-rail input stage distortion.

In battery-powered applications, the supply voltage available to the IC is the voltage of the battery. Unfortunately, the voltage of a battery decreases as it discharges itself through the load. This voltage drop over the lifetime of the battery causes an error in the output of the op amps. Some applications requiring precision measurements during the entire lifetime of the battery use voltage regulators to power up the op amps as a solution. If a design uses standard battery cells, the op amps experience a supply voltage change from roughly 3.2 V to 1.8 V during the lifetime of the battery. This means that for a PSRR of 70 dB minimum in a typical op amp, the input-referred offset error is approximately 440  $\mu\text{V}$ . If the same application uses the ADA4505-x with a 100 dB minimum PSRR, the error is only 14  $\mu\text{V}$ . It is possible to calibrate this error out or to use an external voltage regulator to power the op amp, but these solutions can increase system cost and complexity. The ADA4505-x amplifiers solve the impasse with no additional cost or error-nullifying circuitry.

The second problem with battery-powered applications is the distortion caused by the standard rail-to-rail input stage. Using a CMOS nonrail-to-rail input stage (that is, a single differential pair) limits the input voltage to approximately one  $V_{GS}$  (gate-source voltage) away from one of the supply lines. Because  $V_{GS}$  for normal operation is commonly over 1 V, a single differential pair, input stage op amp greatly restricts the allowable input voltage range when using a low supply voltage. This limitation restricts the number of applications where the nonrail-to-rail input op amp was originally intended to be used. To solve this problem, a dual differential pair input stage is usually implemented (see Figure 53); however, this technique has its own drawbacks.

One differential pair amplifies the input signal when the common-mode voltage is on the high end, whereas the other pair amplifies the input signal when the common-mode voltage is on the low end. This method also requires control circuitry to operate the two differential pairs appropriately. Unfortunately, this topology leads to a very noticeable and undesirable problem; if the signal level moves through the range where one input stage turns off and the other one turns on, noticeable distortion occurs (see Figure 54).

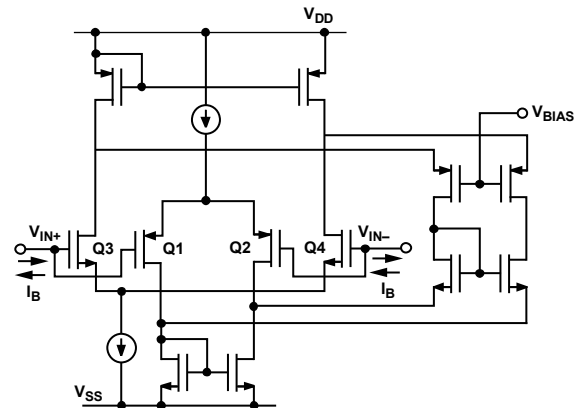

Figure 53. Typical Dual Differential Pair Input Stage Op Amp (Dual PMOS Q1 and Q2 Transistors Form the Lower End of the Input Voltage Range; Dual NMOS Q3 and Q4 Transistors Form the Upper End)

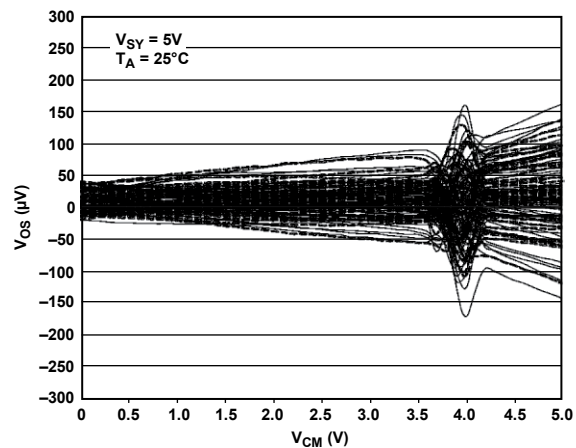

Figure 54. Typical Input Offset Voltage vs. Common-Mode Voltage Response in a Dual Differential Pair Input Stage Op Amp (Powered by a 5 V Supply; Results of Approximately 100 Units per Graph Are Displayed)

This distortion forces the designer to devise impractical ways to avoid the crossover distortion areas, thereby narrowing the common-mode dynamic range of the operational amplifier. The ADA4505-x family solves this crossover distortion problem by using an on-chip charge pump to power the input differential pair. The charge pump creates a supply voltage higher than the voltage of the battery, allowing the input stage to handle a wide range of input signal voltages without using a second differential pair. With this solution, the input voltage can vary from one supply extreme to the other with no distortion, thereby restoring the full common-mode dynamic range of the op amp.

The charge pump has been carefully designed so that switching noise components at any frequency, both within and beyond the amplifier bandwidth, are much lower than the thermal noise floor. Therefore, the spurious-free dynamic range (SFDR) is limited only by the input signal and the thermal or flicker noise. There is no intermodulation between input signal and switching noise.

Figure 55 displays a typical front-end section of an operational amplifier with an on-chip charge pump.

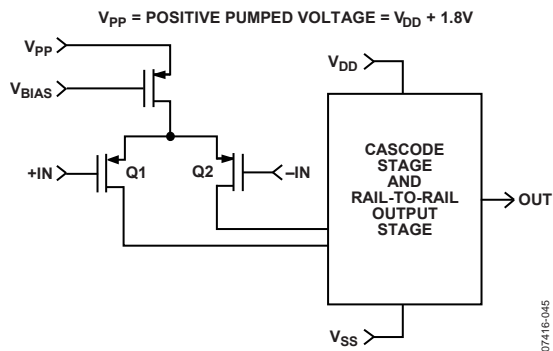

Figure 55. Typical Front-End Section of an Op Amp with Embedded Charge Pump

Figure 56 shows the typical response of two devices from Figure 12, which shows the input offset voltage vs. input common-mode voltage for 10 devices. Figure 56 is expanded to make it easier to compare with Figure 54, which shows the typical input offset voltage vs. common-mode voltage response in a dual differential pair input stage op amp.

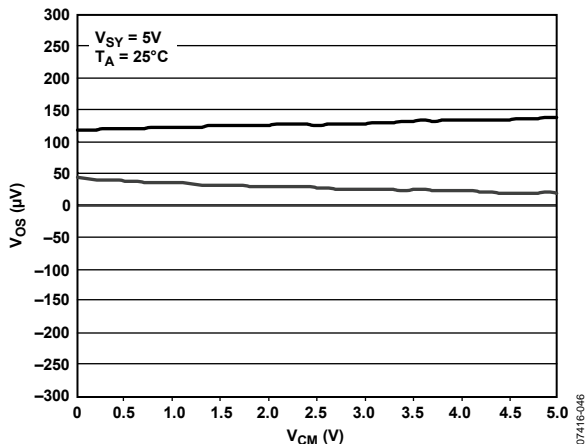

Figure 56. Input Offset Voltage vs. Input Common-Mode Voltage Response (Powered by a 5 V Supply; Results of Two Units Are Displayed)

This solution improves the CMRR performance tremendously. For example, if the input varies from rail to rail on a 2.5 V supply rail, using a part with a CMRR of 70 dB minimum, an input-referred error of 790  $\mu$ V is introduced. Another part with a CMRR of 52 dB minimum generates a 6.3 mV error. The ADA4505-x family CMRR of 90 dB minimum causes only a 79  $\mu$ V error. As with the PSRR error, there are complex ways to minimize this error, but the ADA4505-x family solves this problem without incurring unnecessary circuitry complexity or increased cost.

## APPLICATIONS INFORMATION

### PULSE OXIMETER CURRENT SOURCE

A pulse oximeter is a noninvasive medical device used for continuously measuring the percentage of hemoglobin (Hb) saturated with oxygen and the pulse rate of a patient. Hemoglobin that is carrying oxygen (oxyhemoglobin) absorbs light in the infrared (IR) region of the spectrum; hemoglobin that is not carrying oxygen (deoxyhemoglobin) absorbs visible red (R) light. In pulse oximetry, a clip containing two LEDs (sometimes more, depending on the complexity of the measurement algorithm) and the light sensor (photodiode) is placed on the finger or earlobe of the patient. One LED emits red light (600 nm to 700 nm), and the other emits light in the near IR (800 nm to 900 nm) region. The clip is connected by a cable to a processor unit. The LEDs are rapidly and sequentially excited by two current sources (one for each LED) whose dc levels depend on the LED being driven, based on manufacturer requirements; the detector is synchronized to capture the light from each LED as it is transmitted through the tissue.

An example design of a dc current source driving the red and infrared LEDs is shown in Figure 57. These dc current sources allow 62.5 mA and 101 mA to flow through the red and infrared LEDs, respectively. First, to prolong battery life, the LEDs are driven only when needed. One third of the ADG733 SPDT analog switch is used to disconnect/connect the 1.25 V voltage reference from/to each current circuit. When driving the LEDs, the ADR1581 1.25 V voltage reference is buffered by one half of the ADA4505-2; the presence of this voltage on the noninverting input forces the output of the op amp (due to the negative feedback) to maintain a level that causes its inverting input to track the noninverting pin. Therefore, the 1.25 V appears in parallel with the 20 Ω R1 or 12.4 Ω R5 current source resistor, creating the flow of the 62.5 mA or 101 mA current through the red or infrared LED as the output of the op amp turns on the Q1 or Q2 N-MOSFET IRLMS2002.

The maximum total quiescent currents for one half of the ADA4505-2, the ADR1581, and the ADG733 are 15 μA, 70 μA, and 1 μA, respectively, for a total of 86 μA current consumption (430 μW power consumption) per circuit, which is good for a system powered by a battery. If the accuracy and temperature drift of the total design need improvement, use a more accurate and low temperature coefficient drift voltage reference and current source resistor. C3 and C4 are used to improve stabilization of U1; R3 and R7 are used to provide some current limit into the U1 inverting pin; and R2 and R6 are used to slow the rise time of the N-MOSFET when it turns on. These elements may not be needed, or some bench adjustments may be required.

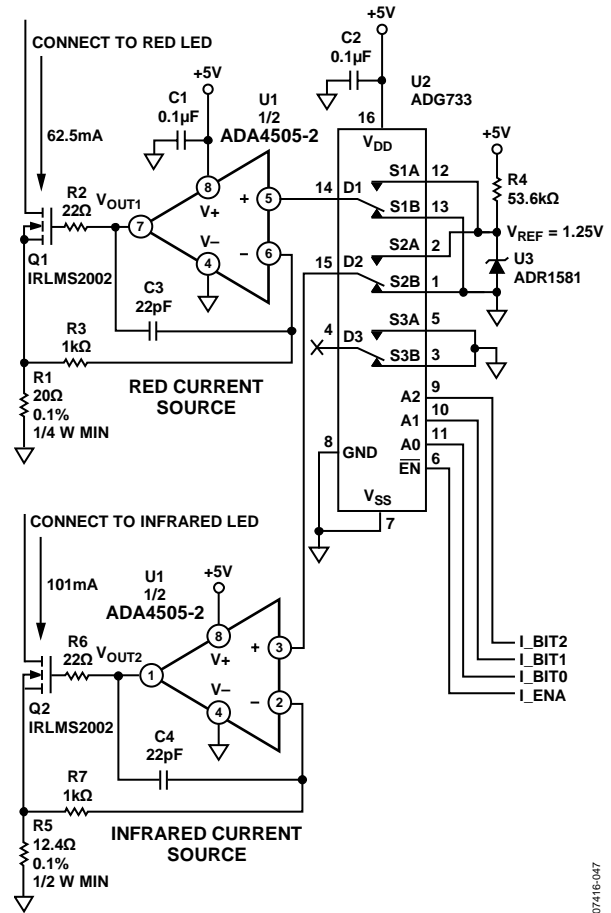

Figure 57. Pulse Oximeter Red and Infrared Current Sources Using the ADA4505-2 as a Buffer to the Voltage Reference Device

07416-047

**FOUR-POLE, LOW-PASS BUTTERWORTH FILTER FOR GLUCOSE MONITOR**

There are several methods of glucose monitoring: spectroscopic absorption of infrared light in the 2 μm to 2.5 μm range, reflectance spectrophotometry, and the amperometric type using electrochemical strips with glucose oxidase enzymes. The amperometric type generally uses three electrodes: a reference electrode, a control electrode, and a working electrode. Although this is a very old and widely used technique, signal-to-noise ratio and repeatability can be improved using the ADA4505-x family, with its low peak-to-peak voltage noise of 2.95 μV from 0.1 Hz to 10 Hz and voltage noise density of 65 nV/√Hz at 1 kHz.

Another consideration is operation from a 3.3 V battery. Glucose signal currents are usually less than 3 μA full scale; therefore, the I-to-V converter requires low input bias current. The ADA4505-x family is an excellent choice because it provides 0.5 pA typical and 2 pA maximum input bias current at ambient temperature.

A low-pass filter with a cutoff frequency of 80 Hz to 100 Hz is desirable in a glucose meter device to remove extraneous noise; this can be a simple two-pole or four-pole Butterworth filter. Low power op amps with bandwidths of 50 kHz to 500 kHz should be adequate. The ADA4505-x family, with its 50 kHz GBP and 7 μA typical current consumption, meets these requirements. A circuit design of a four-pole Butterworth filter (preceded by a one-pole low-pass filter) is shown in Figure 58. With a 3.3 V battery, the total power consumption of this design is 198 μW typical at ambient temperature.

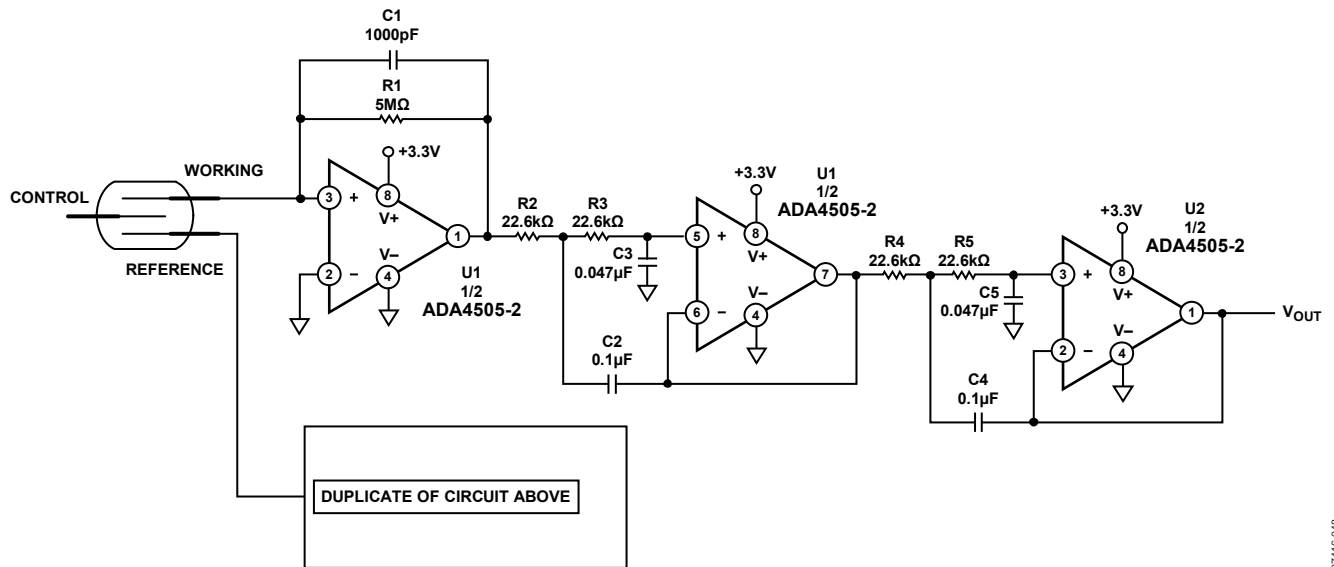
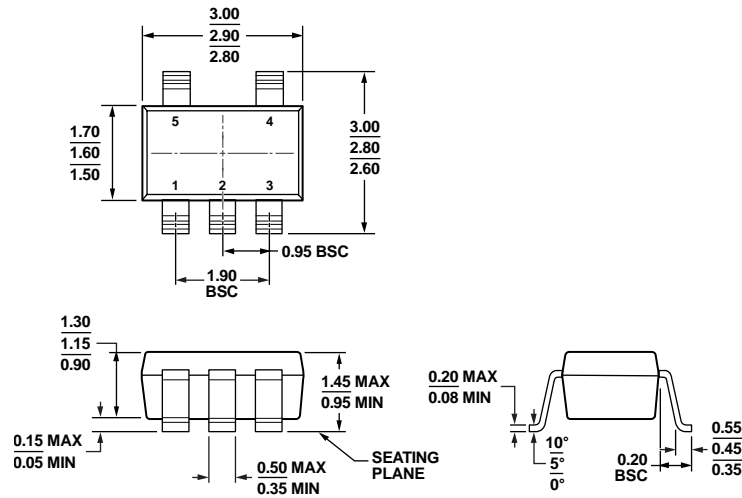

Figure 58. Four-Pole Butterworth Filter That Can Be Used in a Glucose Meter

07416-048

OUTLINE DIMENSIONS



COMPLIANT TO JEDEC STANDARDS MO-178-AA

Figure 59. 5-Lead Small Outline Transistor Package [SOT-23] (RJ-5)

Dimensions shown in millimeters

121608-A

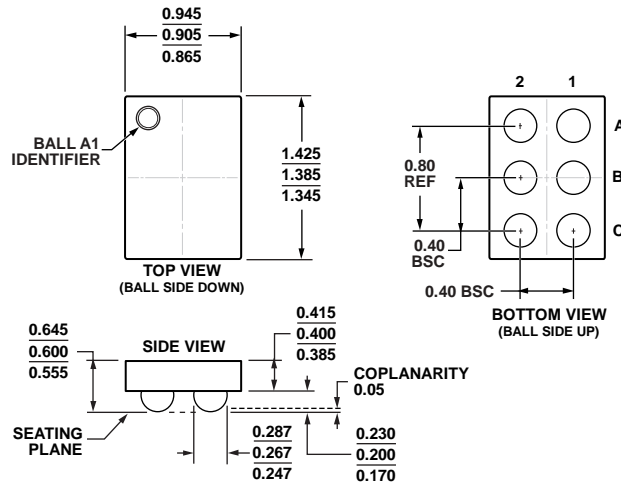

Figure 60. 6-Ball Wafer Level Chip Scale Package [WLCSP] (CB-6-7)

Dimensions shown in millimeters

06-09-2012-A

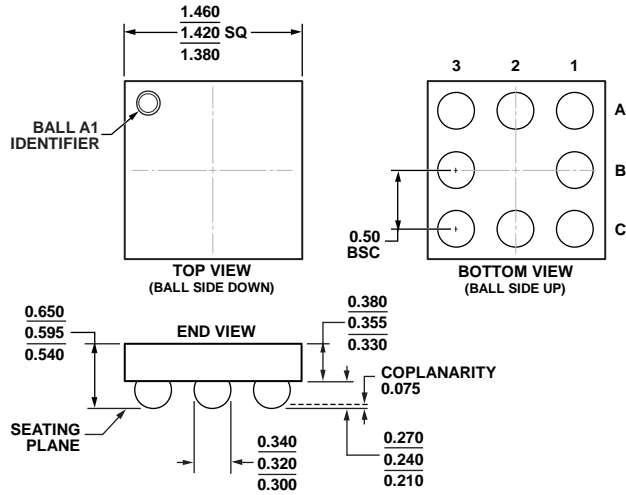
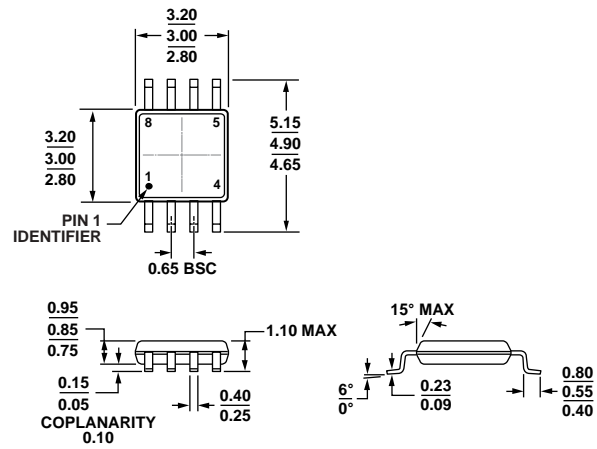

Figure 61. 8-Ball Wafer Level Chip Scale Package [WLCSP]  
(CB-8-2)  
Dimensions shown in millimeters

08-30-2012-A



COMPLIANT TO JEDEC STANDARDS MO-187-AA  
Figure 62. 8-Lead Mini Small Outline Package [MSOP]  
(RM-8)  
Dimensions shown in millimeters

100708-B



**ORDERING GUIDE**

Model <sup>1</sup>	Temperature Range	Package Description	Package Option	Branding
ADA4505-1ARJZ-R2	-40°C to +125°C	5-Lead SOT-23	RJ-5	A2D
ADA4505-1ARJZ-RL	-40°C to +125°C	5-Lead SOT-23	RJ-5	A2D
ADA4505-1ARJZ-R7	-40°C to +125°C	5-Lead SOT-23	RJ-5	A2D
ADA4505-1ACBZ-R7	-40°C to +125°C	6-Ball WLCSP	CB-6-7	A2F
ADA4505-1ACBZ-RL	-40°C to +125°C	6-Ball WLCSP	CB-6-7	A2F
ADA4505-2ACBZ-RL	-40°C to +125°C	8-Ball WLCSP	CB-8-2	A21
ADA4505-2ACBZ-R7	-40°C to +125°C	8-Ball WLCSP	CB-8-2	A21
ADA4505-2ARMZ	-40°C to +125°C	8-Lead MSOP	RM-8	A21
ADA4505-2ARMZ-RL	-40°C to +125°C	8-Lead MSOP	RM-8	A21
ADA4505-4ARUZ	-40°C to +125°C	14-Lead TSSOP	RU-14	
ADA4505-4ARUZ-RL	-40°C to +125°C	14-Lead TSSOP	RU-14	
ADA4505-4ACBZ-RL	-40°C to +125°C	14-Ball WLCSP	CB-14-1	A2A
ADA4505-4ACBZ-R7	-40°C to +125°C	14-Ball WLCSP	CB-14-1	A2A

<sup>1</sup>Z = RoHS Compliant Part.

**NOTES**

**NOTES**

NOTES

## Looking for pricing, stock, or lifecycle information?

Click below to explore more details on WIN SOURCE:

⊖ [View ADA4505-2ACBZ-R7 on WIN SOURCE](#)

⊖ [Analog Devices Inc. Information](#)

## Optimize Your Supply Chain with WIN SOURCE Solutions

- ✓ Global Sourcing Solution
- ✓ Obsolete Management
- ✓ Cost Control Management
- ✓ Shortage Management
- ✓ Alternative Solution
- ✓ Excess Inventory Management