



# THE DATASHEET OF ST735SCD





# ST735S ST735T

## 300kHz, -5V/ADJ INVERTING, NEGATIVE OUTPUT CURRENT-MODE PWM REGULATOR

- CONVERTS +4.0V TO + 6.2V INPUT TO -5V OUTPUT (735S) OR +3.5V TO + 9.0V TO A NEGATIVE ADJUSTABLE OUTPUT (735T)
- 1W GUARANTEED OUTPUT POWER
- 72% TYPICAL EFFICIENCY
- 0.8mA QUIESCENT CURRENT
- 1µA SHUTDOWN MODE
- 300KHZ FIXED FREQUENCY OSCILLATOR
- CURRENT MODE PWM CONVERTER
- LOW NOISE AND JITTER
- SOFT START
- SIMPLE APPLICATION CIRCUIT
- UNDERVOLTAGE LOCKOUT (735S)

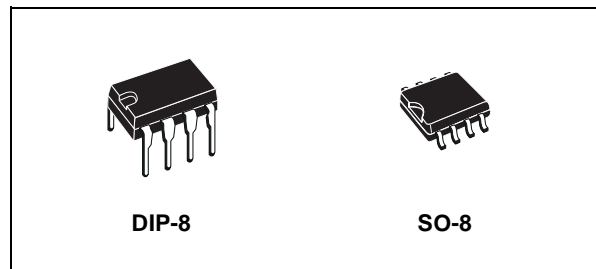

0.8mA and, in shutdown mode it is reduced to 1µA.

These power-conserving features, along with high efficiency and applications circuits, that lend itself to minaturization, make the ST735S/ST735T excellent in a broad range of on-card, HDD and portable equipment applications. These device employ a high performance current mode pulse with modulation (PWM) control scheme to provide tight output voltage regulation and low noise. The fixed frequency oscillator is factory trimmed to 300kHz, allowing for easy noise filtering. The regulator in production is tested to guarantee an output accuracy within  $\pm 5\%$  over all specified conditions.

### DESCRIPTION

The ST735S/ST735T is a Bi-CMOS, inverting switch mode DC-DC regulator with internal Power MOSFET that generates a fixed -5V (S version) or a negative adjustable (T version) output voltage from a 4V (3.5V for the 735T) to 6.2V input voltage (9V for the 735T); is guaranteed an output current of 200mA for inputs greater than 4.5V. The quiescent current for this device is typically of

### SCHEMATIC DIAGRAM

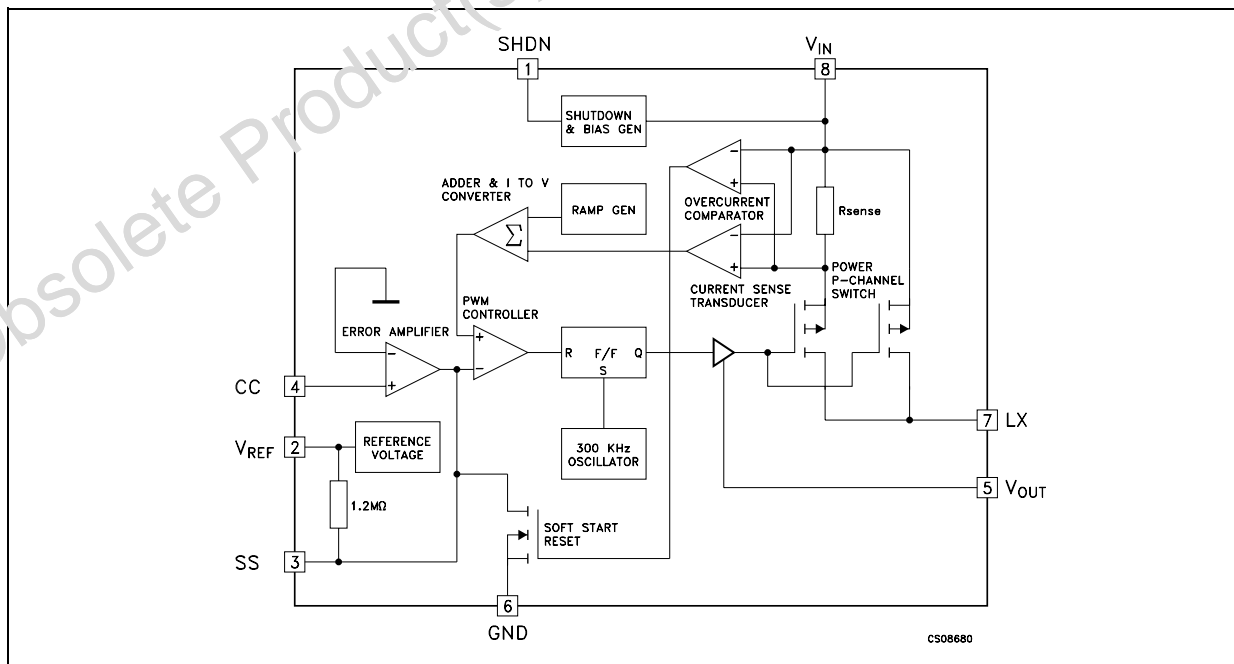

**ABSOLUTE MAXIMUM RATINGS**

Symbol	Parameter	Value	Unit	
$V_{IN}$	DC Input Voltage ( $V_{IN}$ to GND) for ST735S	-0.3 to +7	V	
$V_{IN}$	DC Input Voltage ( $V_{IN}$ to GND) for ST735T (Note 1)	-0.3 to +11	V	
SHDN	Shutdown Voltage (SHDN to GND)	-0.3 to $V_{IN}+0.3$	V	
$V_{LX}$	Switch Voltage (Lx to $V_{IN}$ )	-12.5 to +0.3	V	
$V_{FB}$	Feedback Voltage ( $V_{OUT}$ to GND)	-11 to +0.3	V	
$V_{OUT}$	Output Voltage ( $V_{OUT}$ to GND)	-11 to +0.3	V	
	Other Input Voltage (SS, CC to GND)	-0.3 to $V_{+}+0.3$	V	
$I_{LX}$	Peack Switch Current	2	A	
$P_{tot}$	Power Dissipation at $T_j = 70^{\circ}C$	DIP-8	725	mW
		SO-8	470	
$T_{stg}$	Storage Temperature Range	-55 to +150	$^{\circ}C$	
$T_{op}$	Operating Junction Temperature Range	-40 to +125	$^{\circ}C$	

Absolute Maximum Ratings are those values beyond which damage to the device may occur. Functional operation under these condition is not implied.

Note 1: The input to output differential voltage is limited to  $V_{IN}+|V_{OUT}|<12.7V$

**THERMAL DATA**

Symbol	Parameter	DIP-8	SO-8	Unit
$R_{thj-case}$	Thermal Resistance Junction-case	2	8	$^{\circ}C/W$

**CONNECTION DIAGRAM (top view)**

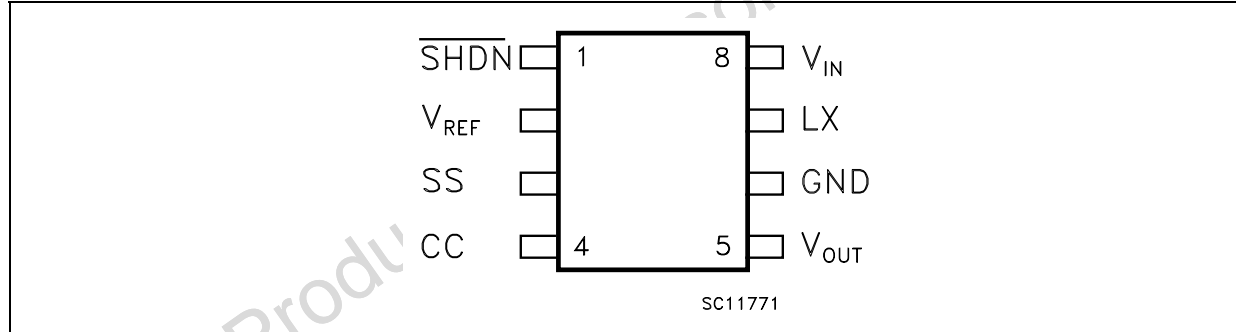

**PIN DESCRIPTION**

Pin N°	Symbol	Name and Function
1	SHDN	SHUT-DOWN Control ( $V_{CC}=ON$ GND=Shutdown)
2	$V_{REF}$	Reference Output Voltage
3	SS	Soft Start
4	CC	Compensation Input
5	$V_{OUT}$	Negative Output Voltage
6	GND	Ground
7	LX	Switch Output
8	$V_{IN}$	Positive Supply - Voltage Input

ORDERING CODES

TYPE	DIP-8	SO-8	SO-8 (T&R)
ST735S	ST735SCN	ST735SCD	ST735SCD-TR
ST735T	ST735TCN	ST735TCD	ST735TCD-TR

TYPICAL APPLICATION CIRCUIT

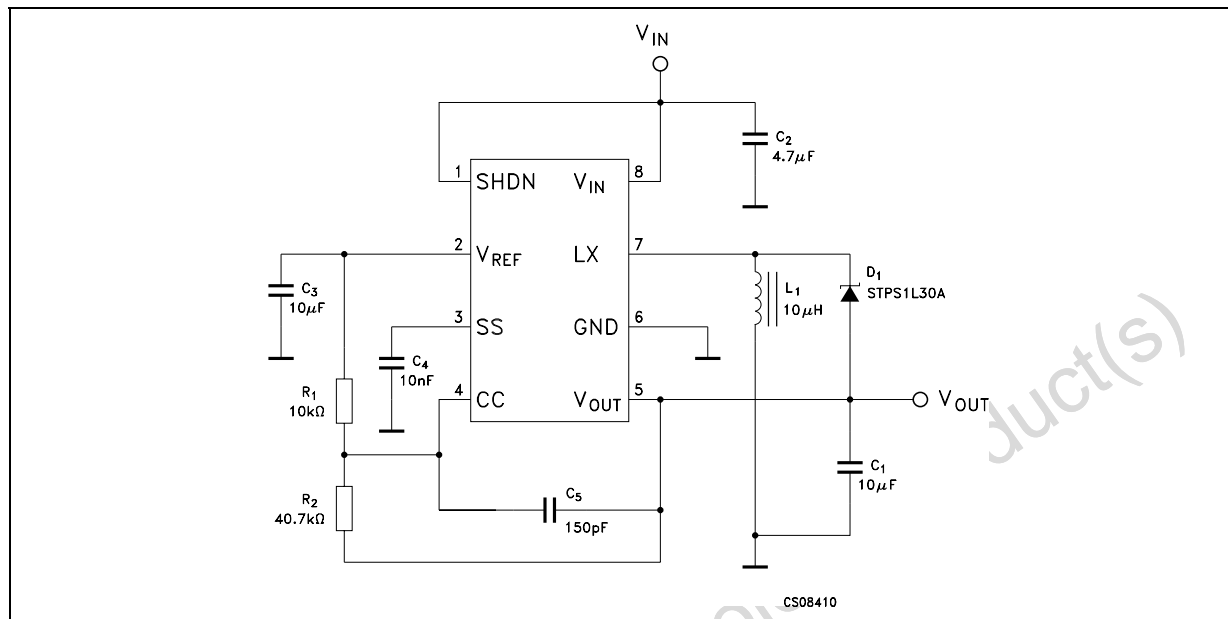

NOTE:

- 1) All capacitors are X7R ceramic
- 2) C<sub>5</sub> can be omitted if are used higher values for the input and output capacitors (suggested C<sub>2</sub>=47µF, C<sub>1</sub>=100µF).
- 3) R<sub>1</sub> and R<sub>2</sub> must be placed is ST735T applications only. Their values are calculated by the following formula  $R_2 = (V_{OUT}/V_{REF}) \times R_1$ . For R<sub>1</sub> can be chosen any value between 2kΩ and 20kΩ

APPLICATION CIRCUIT

To achieve the best performances from switching power supply topology, particular care to layout drawing is needed, in order to minimize EMI and obtain low noise. Moreover, jitter free operation ensures the full device functionality. Layout design proposed on demoboard helps to lower the developing time. Wire lengths must be minimized,

filter and bypass capacitors must be low ESR type, placed as close as possible to the integrated circuit. The 4.7µF (or 6.8µF) inductor must be chosen built on a core, taking care that saturation current should be higher than the peak LX switch current. See the Peak Inductor Current vs Output Current graph.

PRINTED DEMOBOARD (not in scale)

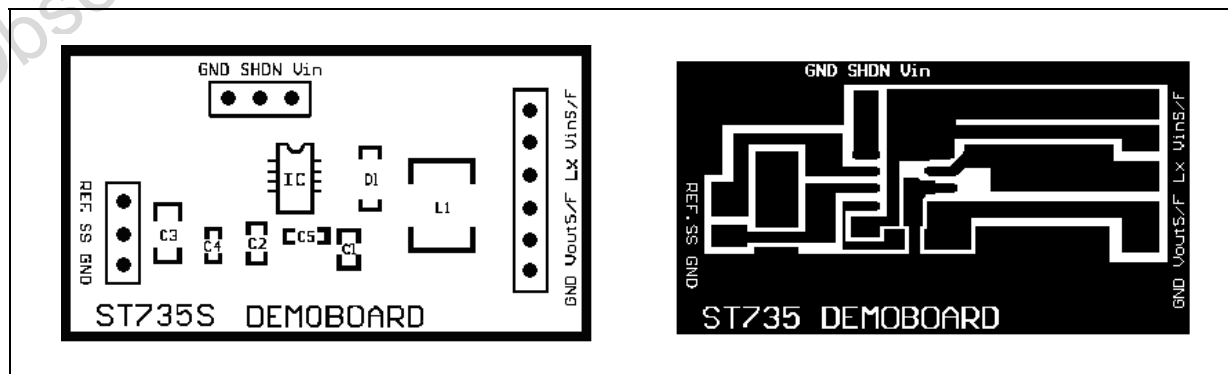

## ST735S/ST735T

**ELECTRICAL CHARACTERISTICS OF ST735S** (Refer to test circuit,  $V_{IN}=5V$ ,  $C_{IN} = 4.7\mu F$ ,  $C_{OUT} = 10\mu F$  all X7R ceramic,  $L = 4.7\mu H$  (Note1) ,  $I_{OUT}=0mA$ ,  $T_{amb} = -40$  to  $125^{\circ}C$ , unless otherwise specified. Typical value are referred at  $T_{amb} = 25^{\circ}C$ )

Symbol	Parameter	Test Conditions	Min.	Typ.	Max.	Unit
$V_{IN}$	Input Voltage		4		6.2	V
$V_{OUT}$	Output Voltage	$V_{IN} = 4.5V$ to $6.2V$ $I_{OUT} = 0$ to $200mA$ $T_{amb} = -40$ to $125^{\circ}C$	-5.25	-5	-4.75	V
		$V_{IN} = 4.0V$ to $6.2V$ $I_{OUT} = 0$ to $175mA$ $T_{amb} = -40$ to $125^{\circ}C$	-5.25	-5	-4.75	V
$I_{OUT}$	Output Current	$V_{IN} = 4.5V$ to $6.2V$ $T_J = 0$ to $125^{\circ}C$	200	275		mA
		$V_{IN} = 4.5V$ to $6.2V$ $I_{OUT} = 0$ to $175mA$ $T_{amb} = -40$ to $125^{\circ}C$	175			mA
		$V_{IN} = 4.0V$ $V_{OUT} = -5V$		175		mA
$I_{SUPPLY}$	Supply Current	Includes Switch Current		0.8	1.6	mA
$I_{STANDBY}$	Standby Current	$V_{SHDN} = 0V$		1	10	$\mu A$
$I_{SC}$	Short Circuit Current	$V_{IN} = 5V$		0.9		A
$I_{PEAK}$	LX Max Peak Current	(Note 2)		1.5		A
$V_{LO}$	Undervoltage Lock-out			3.5	4	V
$\Delta V_{OUT}$	Line Regulation	$V_{IN} = 4.0V$ to $6.2V$		0.1		%/V
$\Delta V_{OUT}$	Load Regulation	$I_{OUT} = 0$ to $200mA$		0.003		%/mA
$V_{REF}$	Reference Voltage	$T_{amb} = 25^{\circ}C$ (Note 3)		1.225		V
$\Delta V_{REF}$	Reference Drift	$T_{amb} = -40$ to $125^{\circ}C$		50		ppm/ $^{\circ}C$
$R_{DSON}$	LX ON Voltage			0.5		$\Omega$
$I_{LEAK}$	LX Leakage Current	$V_{DS} = 10V$		1		$\mu A$
$I_{SH}$	Shutdown Pin Current				1	$\mu A$
$V_{IL}$	Shutdown Input Low Threshold				0.25	V
$V_{IH}$	Shutdown Input High Threshold		2			V
$f_{OSC}$	Maximum Oscillator Frequency			300		KHz
$\eta$	Efficiency	$I_{OUT} = 100mA$		72		%
$R_{CC}$	Compensation Pin Impedance on CC Pin			7.5		K $\Omega$

Note 1: Utilize of  $6.8\mu H$  permits to reach higher current capability at the same operating conditions

Note2: Guaranteed by design, but not tested in production

Note3 : Tested at  $I_{VREF} = 125\mu A$

**ELECTRICAL CHARACTERISTICS OF ST735T** (Refer to test circuit,  $V_{IN}=5V$ ,  $C_{IN} = 4.7\mu F$ ,  $C_{OUT} = 10\mu F$  all X7R ceramic,  $L = 4.7\mu H$  (Note1) ,  $I_{OUT}=0mA$ ,  $V_O$  adjusted to  $-5V$ ,  $T_{amb} = -40$  to  $125^\circ C$ , unless otherwise specified. Typical value are referred at  $T_{amb}= 25^\circ C$ )

Symbol	Parameter	Test Conditions	Min.	Typ.	Max.	Unit
$V_{IN}$	Input Voltage		3.5		9	V
$V_O$	Output Voltage	$V_{IN} = 4.5V$ to $6.2V$ $I_{OUT} = 0$ to $200mA$ $T_{amb} = -40$ to $125^\circ C$	-5.25	-5	-4.75	V
		$V_{IN} = 4.0V$ to $6.2V$ $I_{OUT} = 0$ to $175mA$ $T_{amb} = -40$ to $125^\circ C$	-5.25	-5	-4.75	V
$I_O$	Output Current	$V_{IN} = 4.5V$ to $6.2V$ $T_{amb} = 0$ to $125^\circ C$	200	275		mA
		$V_{IN} = 4.5V$ to $6.2V$ $I_{OUT} = 0$ to $175mA$ $T_{amb} = -40$ to $125^\circ C$	175			mA
		$V_{IN} = 4.0V$ $V_{OUT} = -5V$		175		mA
$I_{SUPPLY}$	Supply Current	Includes Switch Current		0.8	1.6	mA
$I_{STANDBY}$	Standby Current	$V_{SHDN} = 0V$		1	10	$\mu A$
$I_{SC}$	Short Circuit Current	$V_{IN} = 5V$		0.9		A
$I_{PEAK}$	LX Max Peak Current	(Note 2)		1.5		A
$V_{LO}$	Undervoltage Lock-out			3.5	4	V
$\Delta V_{OUT}$	Line Regulation	$V_{IN} = 4.0V$ to $6.2V$		0.1		%/V
$\Delta V_{OUT}$	Load Regulation	$I_{OUT} = 0$ to $200mA$		0.003		%/mA
$V_{REF}$	Reference Voltage	$T_{amb} = 25^\circ C$ (Note 3)		1.225		V
$\Delta V_{REF}$	Reference Drift	$T_{amb} = -40$ to $125^\circ C$		50		ppm/ $^\circ C$
$R_{DSON}$	LX ON Voltage			0.5		$\Omega$
$I_{LEAK}$	LX Leakage Current	$V_{DS} = 10V$		1		$\mu A$
$I_{SH}$	Shutdown Pin Current				1	$\mu A$
$V_{IL}$	Shutdown Input Low Threshold				0.25	V
$V_{IH}$	Shutdown Input High Threshold		2			V
$f_{OSC}$	Maximum Oscillator Frequency			300		KHz
$\eta$	Efficiency	$I_{OUT} = 100mA$		72		%
$R_{CC}$	Compensation Pin Impedance on CC Pin			7.5		K $\Omega$

Note 1: Utilize of  $6.8\mu H$  permits to reach higher current capability at the same operating conditions

Note2: Guaranteed by design, but not tested in production

Note3 : Tested at  $I_{VREF} = 125\mu A$

**TYPICAL CHARACTERISTICS** (Referred to typical application circuit,  $T_{amb}=25^{\circ}\text{C}$  unless otherwise specified)

**Figure 1 : Output Voltage vs Temperature**

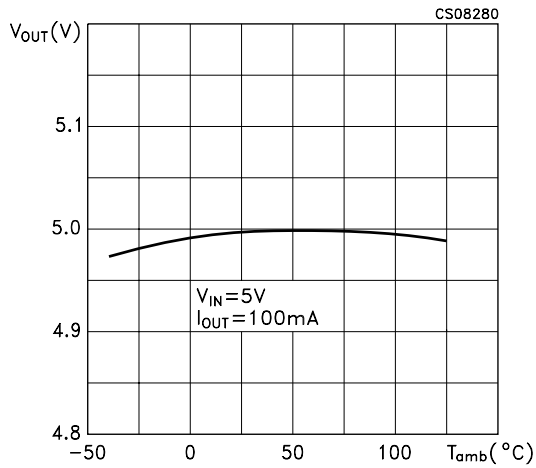

**Figure 2 : Reference Voltage vs Temperature**

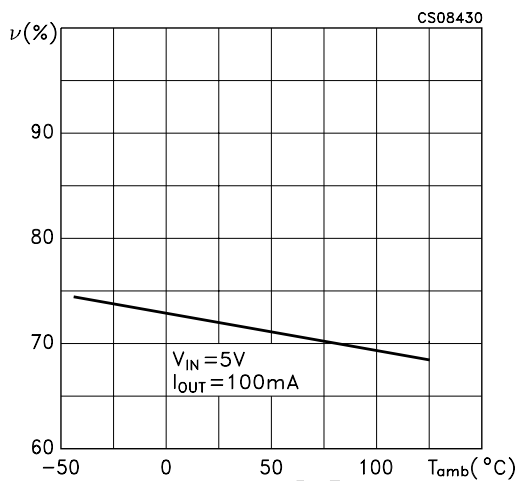

**Figure 3 : Efficiency vs Temperature**

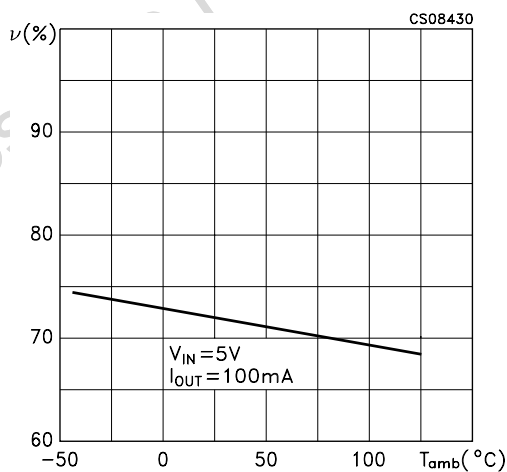

**Figure 4 : Efficiency vs Ouput Current**

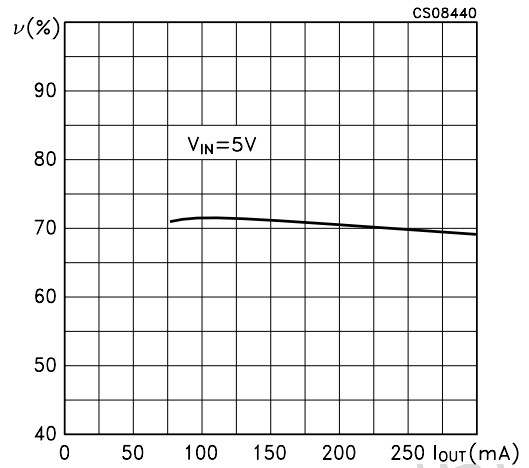

**Figure 5 : Efficiency vs Low Ouput Current**

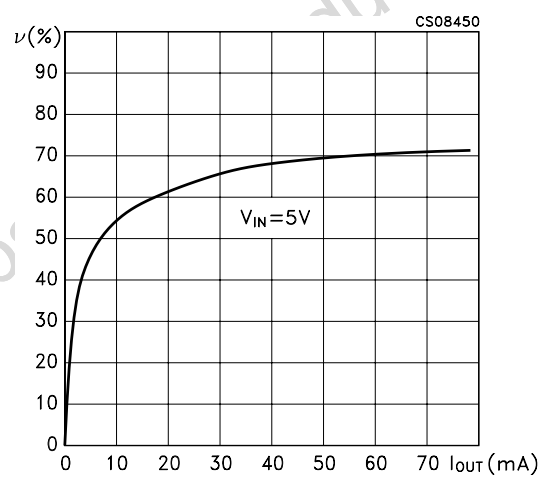

**Figure 6 : Supply Current vs Temperature**

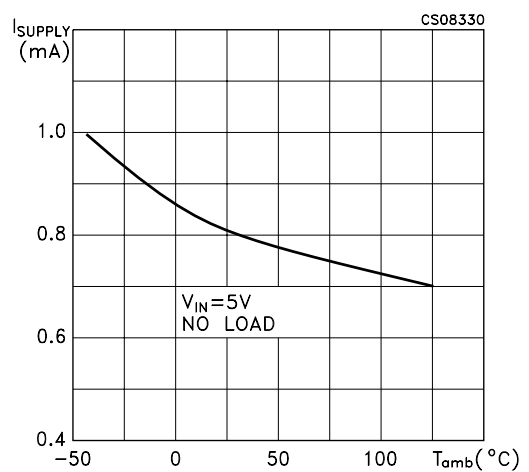

**Figure 7 : Supply Current vs Input Voltage for ST735S**

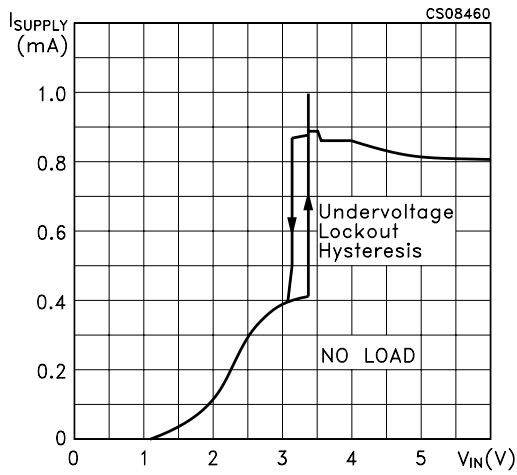

**Figure 10 : Peak Inductor vs Output Current**

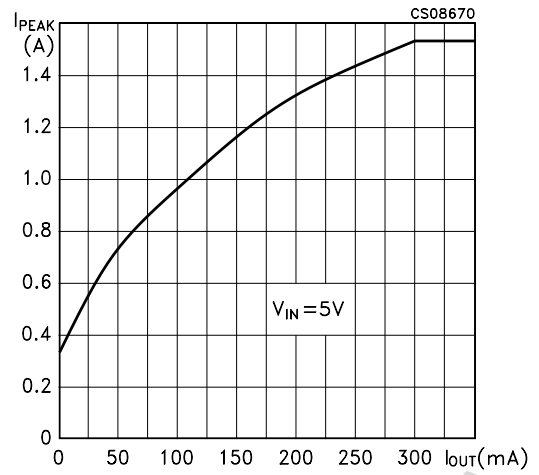

**Figure 8 : Supply Current vs Input Voltage for ST734T**

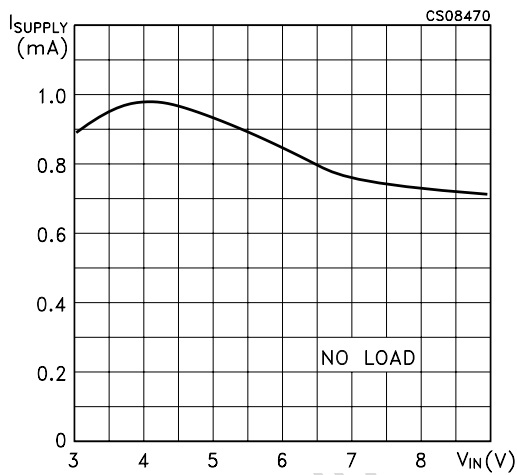

**Figure 11 : Switch Current Limit vs Soft Start Voltage**

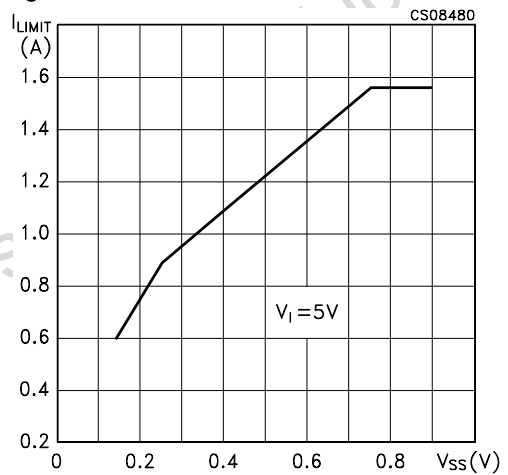

**Figure 9 : Shutdown Threshold vs Temperature**

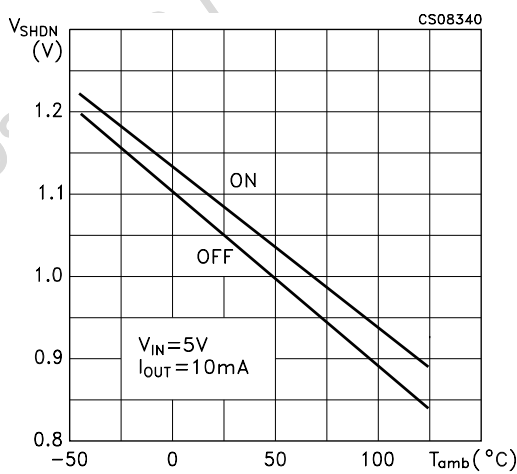

**Figure 12 : Oscillator Frequency Vs Temperature**

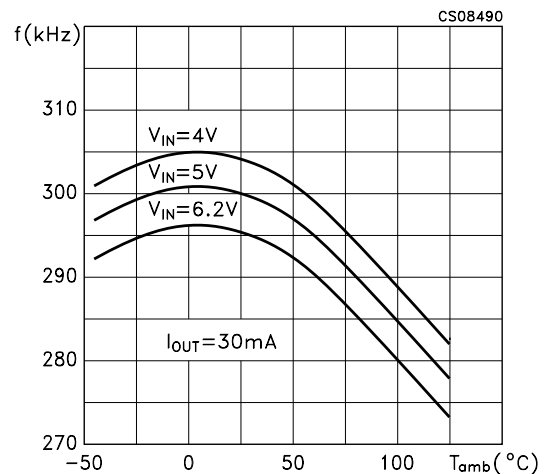

Figure 13 : LX On Resistance vs Temperature

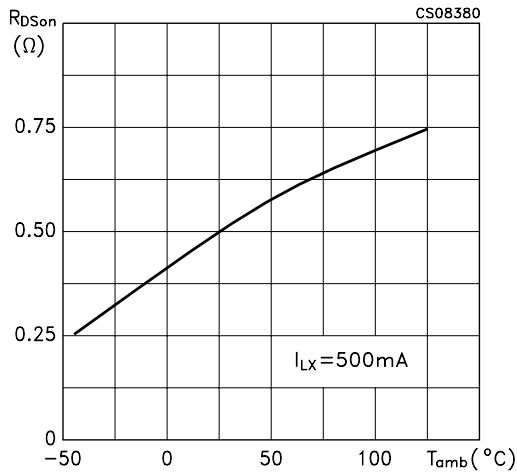

Figure 14 : LX On Resistance vs Input Voltage

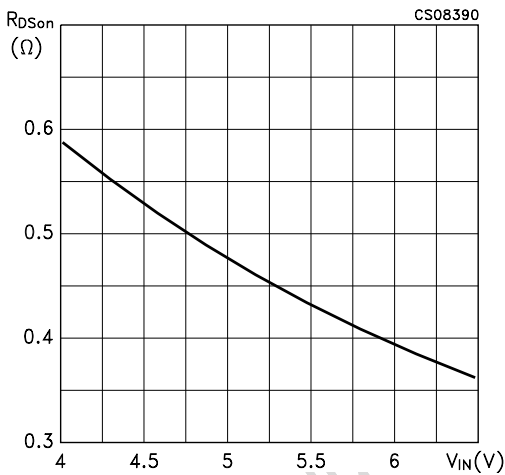

Figure 15 : Load Transient

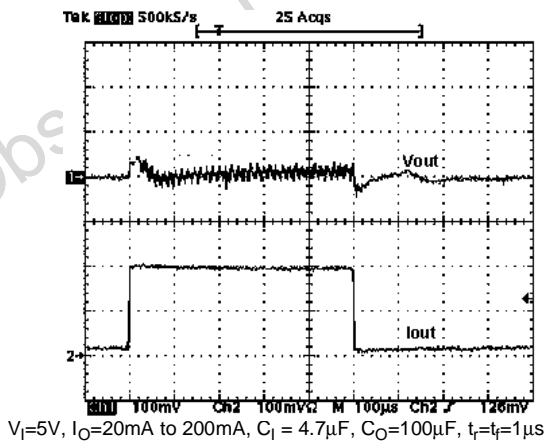

Figure 16 : Load Transient

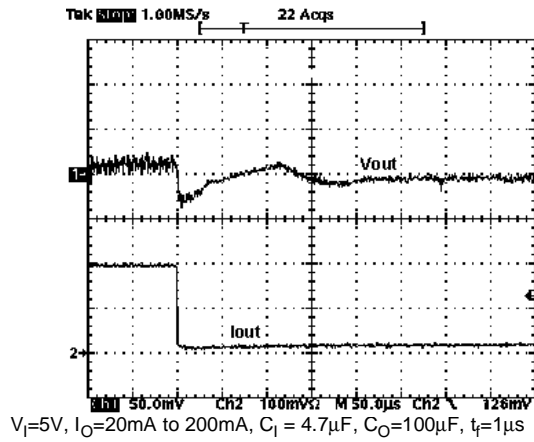

Figure 17 : Load Transient

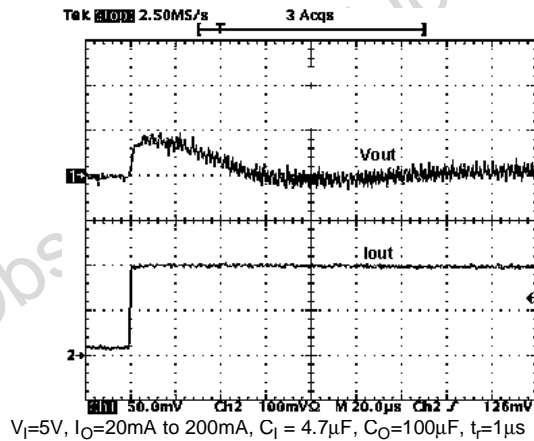
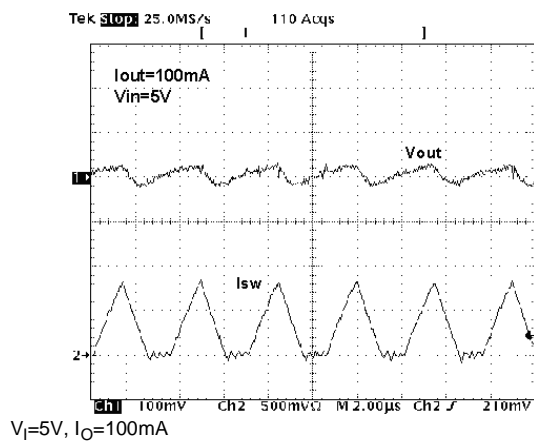
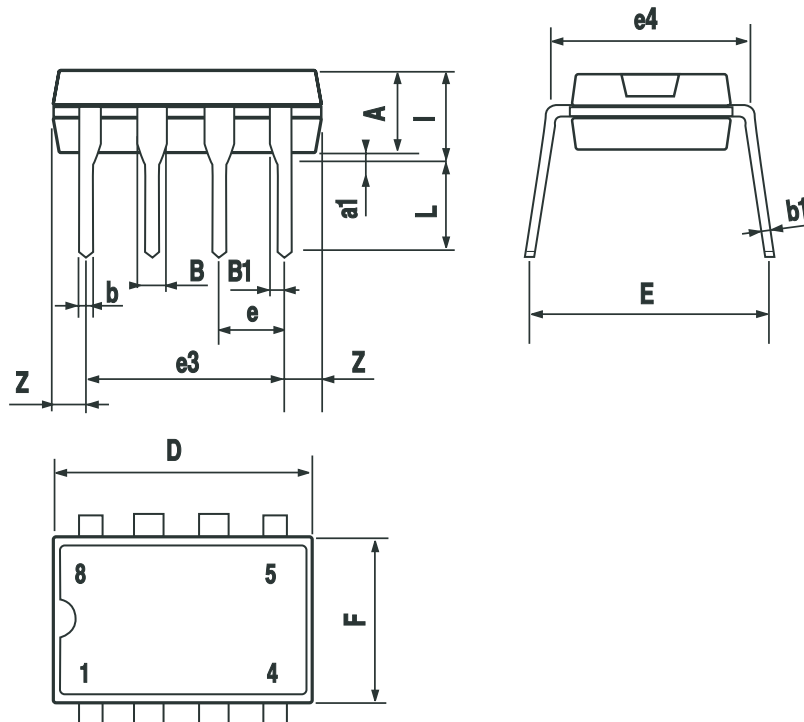

Figure 18 : Switching Waveform



## Plastic DIP-8 MECHANICAL DATA

DIM.	mm.			inch		
	MIN.	TYP.	MAX.	MIN.	TYP.	MAX.
A		3.3			0.130	
a1	0.7			0.028		
B	1.39		1.65	0.055		0.065
B1	0.91		1.04	0.036		0.041
b		0.5			0.020	
b1	0.38		0.5	0.015		0.020
D			9.8			0.386
E		8.8			0.346	
e		2.54			0.100	
e3		7.62			0.300	
e4		7.62			0.300	
F			7.1			0.280
l			4.8			0.189
L		3.3			0.130	
Z	0.44		1.6	0.017		0.063



P001F

**SO-8 MECHANICAL DATA**

DIM.	mm.			inch		
	MIN.	TYP.	MAX.	MIN.	TYP.	MAX.
A			1.75			0.068
a1	0.1		0.25	0.003		0.009
a2			1.65			0.064
a3	0.65		0.85	0.025		0.033
b	0.35		0.48	0.013		0.018
b1	0.19		0.25	0.007		0.010
C	0.25		0.5	0.010		0.019
c1	45° (typ.)					
D	4.8		5.0	0.189		0.196
E	5.8		6.2	0.228		0.244
e		1.27			0.050	
e3		3.81			0.150	
F	3.8		4.0	0.149		0.157
L	0.4		1.27	0.015		0.050
M			0.6			0.023
S	8° (max.)					

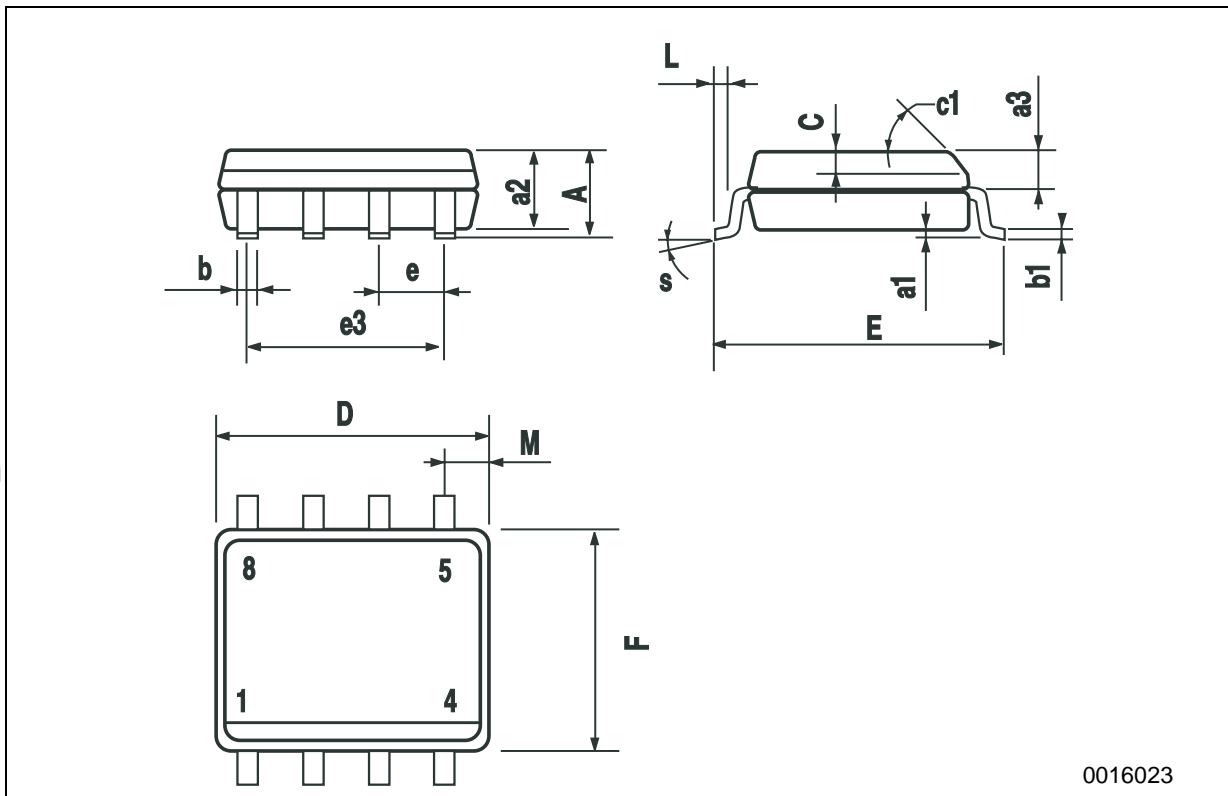

0016023

Information furnished is believed to be accurate and reliable. However, STMicroelectronics assumes no responsibility for the consequences of use of such information nor for any infringement of patents or other rights of third parties which may result from its use. No license is granted by implication or otherwise under any patent or patent rights of STMicroelectronics. Specifications mentioned in this publication are subject to change without notice. This publication supersedes and replaces all information previously supplied. STMicroelectronics products are not authorized for use as critical components in life support devices or systems without express written approval of STMicroelectronics.

© The ST logo is a registered trademark of STMicroelectronics



© 2002 STMicroelectronics - Printed in Italy - All Rights Reserved  
STMicroelectronics GROUP OF COMPANIES

Australia - Brazil - Canada - China - Finland - France - Germany - Hong Kong - India - Israel - Italy - Japan - Malaysia - Malta - Morocco  
Singapore - Spain - Sweden - Switzerland - United Kingdom - United States.

© <http://www.st.com>

## Looking for pricing, stock, or lifecycle information?

Click below to explore more details on WIN SOURCE:

-  [View ST735SCD on WIN SOURCE](#)
-  [STMicroelectronics Information](#)

## Optimize Your Supply Chain with WIN SOURCE Solutions

-  Global Sourcing Solution
-  Obsolete Management
-  Cost Control Management
-  Shortage Management
-  Alternative Solution
-  Excess Inventory Management