

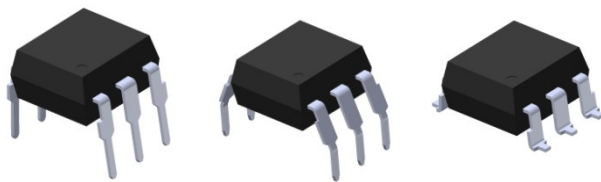

# THE DATASHEET OF EL3061



## 6 PIN DIP ZERO-CROSS TRIAC DRIVER PHOTOCOUPLER EL303X, EL304X, EL306X, EL308X Series



### Features:

- Peak breakdown voltage
  - 250V: EL303X
  - 400V: EL304X
  - 600V: EL306X
  - 800V: EL308X
- High isolation voltage between input and output (Viso=5000 V rms )
- Zero voltage crossing
- Pb free and RoHS compliant.
- UL approved (No. E214129)
- VDE approved (No.132249)
- SEMKO approved
- NEMKO approved
- DEMKO approved
- FIMKO approved
- CSA approved

### Schematic

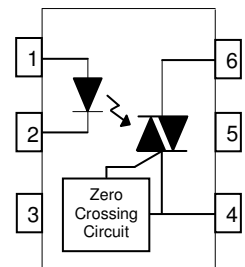

### Pin Configuration

1. Anode
2. Cathode
3. No Connection
4. Terminal
5. Substrate  
(do not connect)
6. Terminal

### Description

The EL303X, EL304X, EL306X and EL308X series of devices each consist of a GaAs infrared emitting diode optically coupled to a monolithic silicon zero voltage crossing photo triac.

They are designed for use with a discrete power triac in the interface of logic systems to equipment powered from 110 to 380 VAC lines, such as solid-state relays, industrial controls, motors, solenoids and consumer appliances.

### Applications

- Solenoid/valve controls
- Light controls
- Static power switch
- AC motor drivers
- E.M. contactors
- Temperature controls
- AC Motor starters

**Absolute Maximum Ratings (Ta=25°C)**

Parameter		Symbol	Rating	Unit	
Input	Forward current	$I_F$	60	mA	
	Reverse voltage	$V_R$	6	V	
	Power dissipation Derating factor (above $T_a = 85^\circ\text{C}$ )	$P_D$	100 3.8	mW mW / °C	
Output			EL303X	250	
	Off-state Output Terminal Voltage	$V_{DRM}$	EL304X	400	V
			EL306X	600	
			EL308X	800	
			Peak Repetitive Surge Current (pw=1ms, 120pps)	$I_{TSM}$	
	On-State RMS Current	$I_{T(RMS)}$	100	mA	
	Power dissipation Derating factor (above $T_a = 85^\circ\text{C}$ )	$P_C$	300 7.6	mW mW/°C	
Total power dissipation	$P_{TOT}$	330	mW		
Isolation voltage <sup>*1</sup>	$V_{ISO}$	5000	Vrms		
Operating temperature	$T_{OPR}$	-55 to 100	°C		
Storage temperature	$T_{STG}$	-55 to 125	°C		
Soldering Temperature <sup>*2</sup>	$T_{SOL}$	260	°C		

Notes:

\*1 AC for 1 minute, R.H.= 40 ~ 60% R.H. In this test, pins 1, 2&3 are shorted together, and pins 4, 5 & 6 are shorted together.

\*2 For 10 seconds

**Electro-Optical Characteristics (Ta=25°C unless specified otherwise)**

**Input**

Parameter	Symbol	Min.	Typ.*	Max.	Unit	Condition
Forward Voltage	$V_F$	-	-	1.5	V	$I_F = 30\text{mA}$
Reverse Leakage current	$I_R$	-	-	10	$\mu\text{A}$	$V_R = 6\text{V}$

**Output**

Parameter	Symbol	Min.	Typ.*	Max.	Unit	Condition
Peak Blocking Current	$I_{\text{DRM1}}$	-	-	100 500	nA	$V_{\text{DRM}} = \text{Rated } V_{\text{DRM}}$ $I_F = 0\text{mA}$
Peak On-state Voltage	$V_{\text{TM}}$	-	-	3	V	$I_{\text{TM}} = 100\text{mA peak}$ , $I_F = \text{Rated } I_{\text{FT}}$
Critical Rate of Rise off-state Voltage	$dv/dt$	1000 600	-	-	V/ $\mu\text{s}$	$V_{\text{PEAK}} = \text{Rated } V_{\text{DRM}}$ , $I_F = 0$ (Fig. 10)
Inhibit Voltage (MT1-MT2 voltage above which device will not trigger)	$V_{\text{INH}}$	-	-	20	V	$I_F = \text{Rated } I_{\text{FT}}$
Leakage in Inhibited State	$I_{\text{DRM2}}$	-	-	500	$\mu\text{A}$	$I_F = \text{Rated } I_{\text{FT}}$ , $V_{\text{DRM}} = \text{Rated } V_{\text{DRM}}$ , off state

**Transfer Characteristics**

Parameter	Symbol	Min.	Typ.*	Max.	Unit	Condition
LED Trigger Current	$I_{\text{FT}}$	-	-	15 10 5	mA	Main terminal Voltage=3V
Holding Current	$I_H$	-	280	-	$\mu\text{A}$	

\* Typical values at  $T_a = 25^\circ\text{C}$

Typical Electro-Optical Characteristics Curves

Figure 1. Forward Current vs Forward Voltage



Figure 2. On-State Characteristics

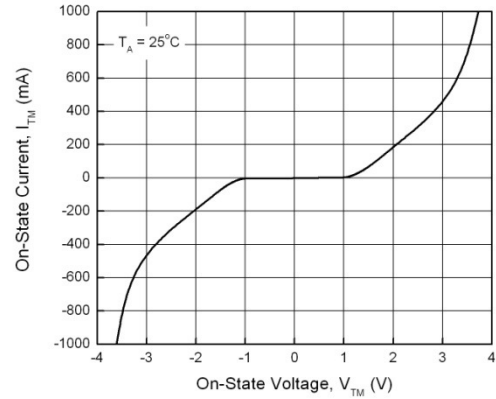

Figure 3. Holding Current vs. Ambient Temperature

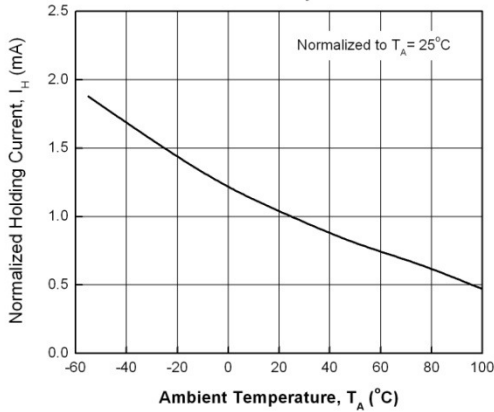

Figure 4. LED Current Required to Trigger vs. LED Pulse Width

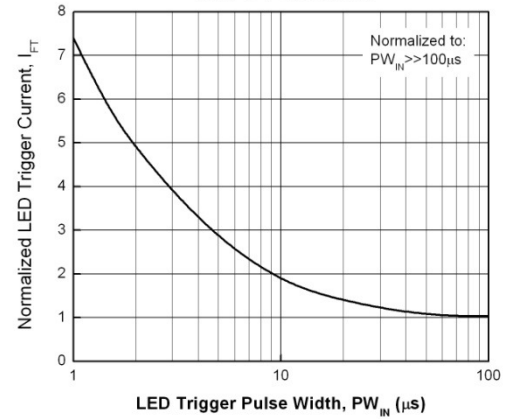

Figure 5. Leakage Current vs. Ambient Temperature

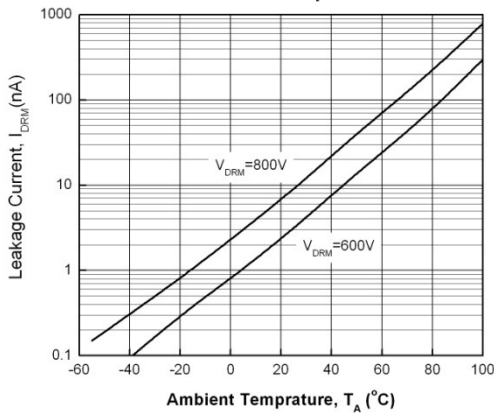

Figure 6. LED Trigger Current vs. Ambient Temperature

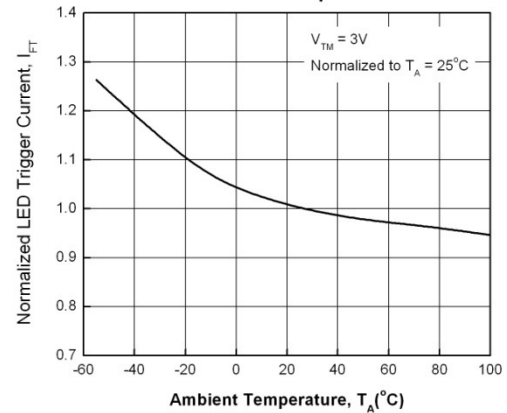

Figure 7. Off-State Output Terminal Voltage vs. Ambient Temperature



Figure 8. Leakage in Inhibit State vs. Ambient Temperature

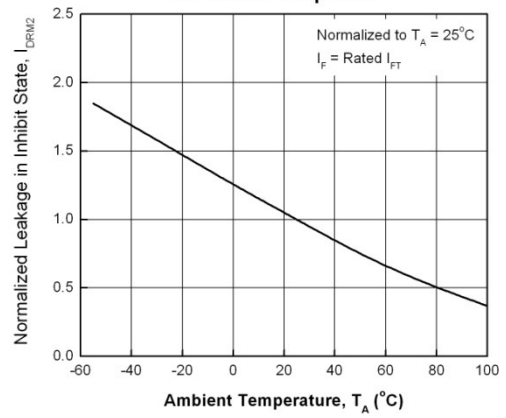

Figure 9. Inhibit Voltage vs. Ambient Temperature

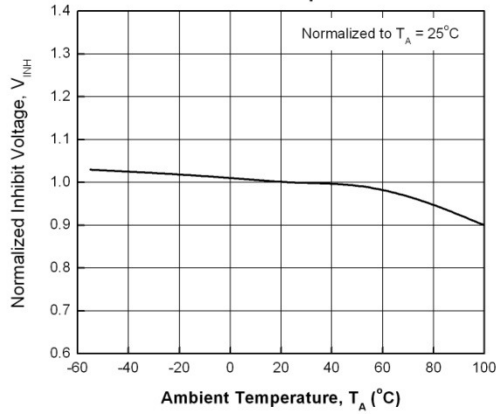

Figure 10. Static dv/dt Test Circuit & Waveform



### Measurement Method

The high voltage pulse is set to the required  $V_{PEAK}$  value and applied to the D.U.T. output side through the RC circuit above. LED current is not applied. The waveform  $V_T$  is monitored using a x100 scope probe. By varying  $R_{TEST}$ , the  $dv/dt$  (slope) is increased, until the D.U.T. is observed to trigger (waveform collapses). The  $dv/dt$  is then decreased until the D.U.T. stops triggering. At this point,  $\tau_{RC}$  is recorded and the  $dv/dt$  calculated.

$$dv/dt = \frac{0.632 \times V_{PEAK}}{\tau_{RC}}$$

For example,  $V_{PEAK} = 600V$  for EL306X series. The  $dv/dt$  value is calculated as follows:

$$dv/dt = \frac{0.63 \times 600}{\tau_{RC}} = \frac{378}{\tau_{RC}}$$

## Order Information

### Part Number

**EL303XY(Z)-V**  
or **EL304XY(Z)-V**  
or **EL306XY(Z)-V**  
or **EL308XY(Z)-V**

### Note

X = Part No. (1, 2 or 3)

Y = Lead form option (S, S1, M or none)

Z = Tape and reel option (TA, TB or none).

V = VDE safety approved option

Option	Description	Packing quantity
None	Standard DIP-6	65 units per tube
M	Wide lead bend (0.4 inch spacing)	65 units per tube
S (TA)	Surface mount lead form + TA tape & reel option	1000 units per reel
S (TB)	Surface mount lead form + TB tape & reel option	1000 units per reel
S1 (TA)	Surface mount lead form (low profile) + TA tape & reel option	1000 units per reel
S1 (TB)	Surface mount lead form (low profile) + TB tape & reel option	1000 units per reel

## Package Dimension (Dimensions in mm)

### Standard DIP Type

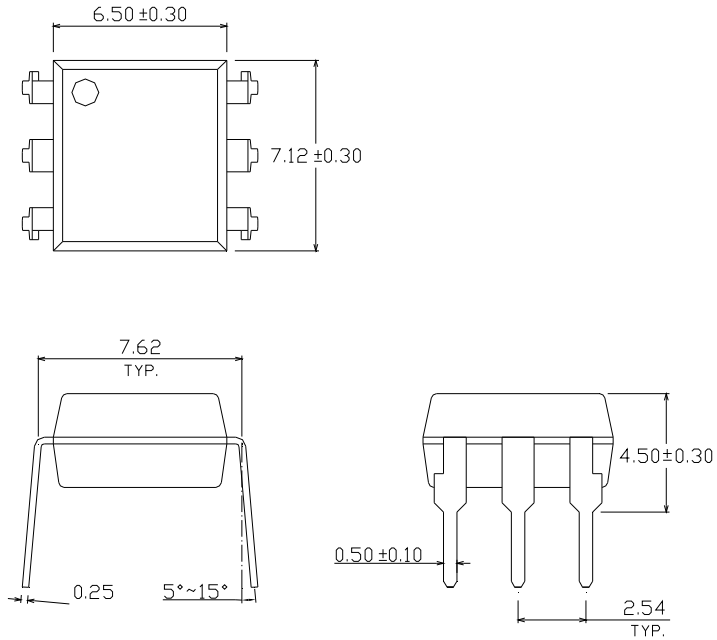

### Option M Type



**Option S Type**

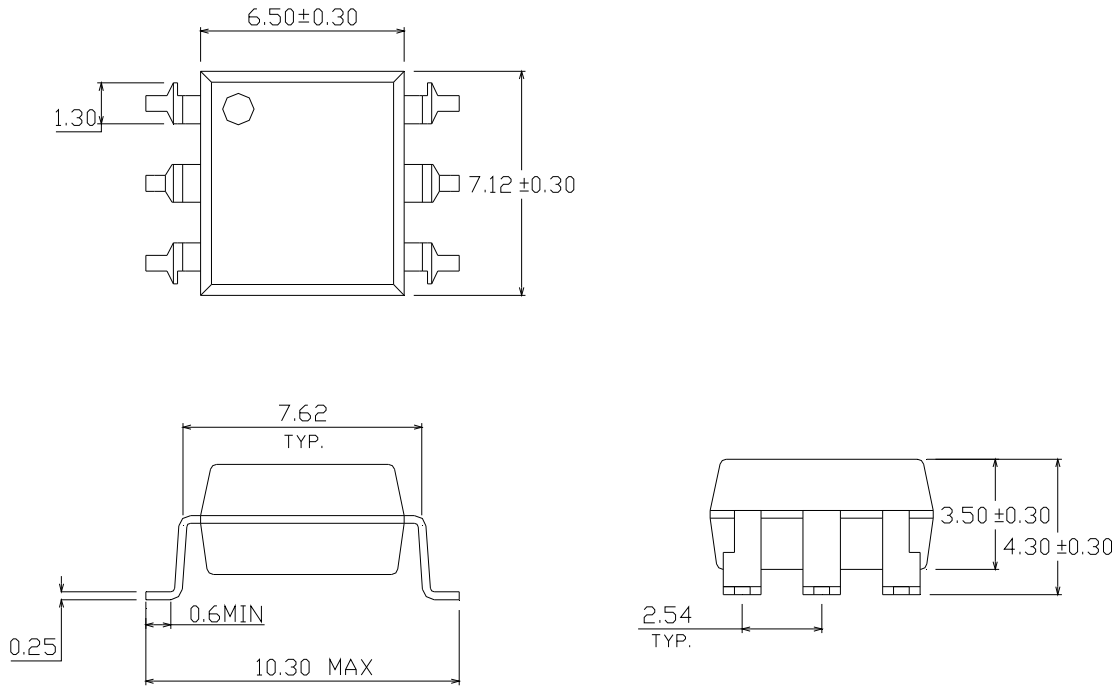

**Option S1 Type**

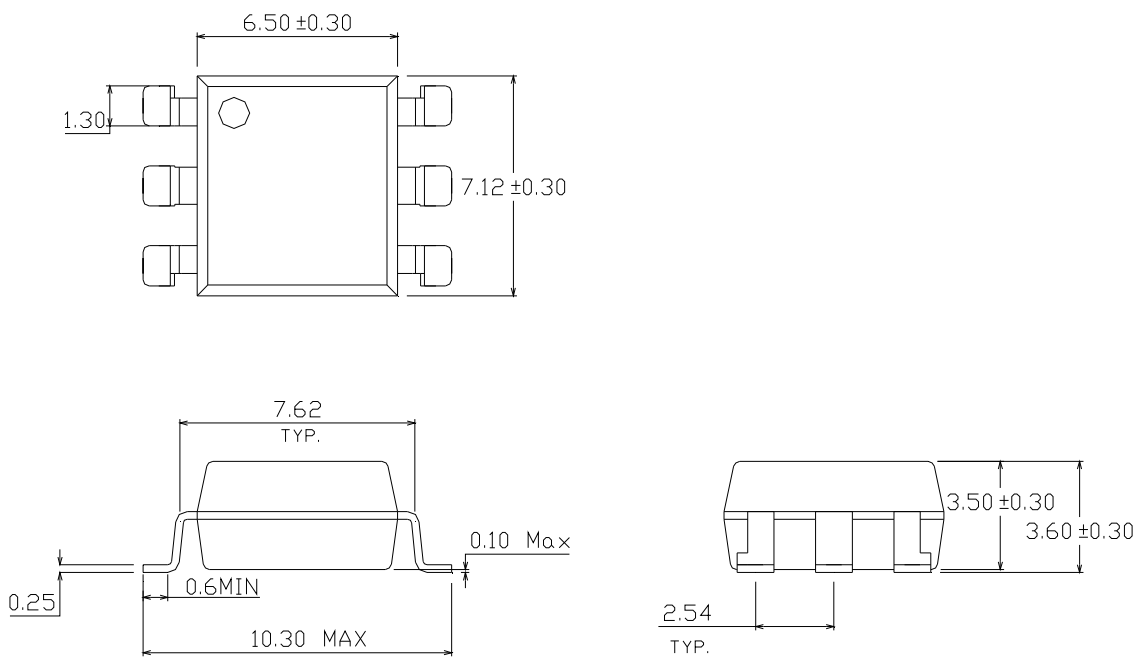

### Recommended pad layout for surface mount leadform

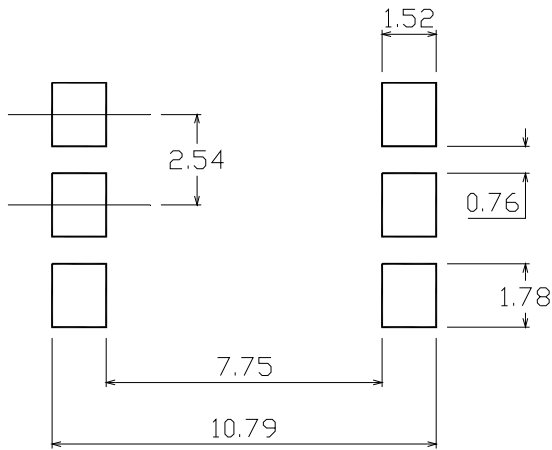

### Device Marking



### Notes

- EL denotes Everlight
- 3083 denotes Device Number
- Y denotes 1 digit Year code
- WW denotes 2 digit Week code
- V denotes VDE option

**Tape & Reel Packing Specifications**

**Option TA**



**Option TB**

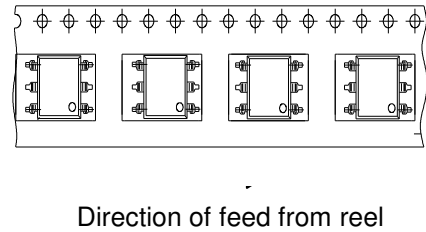

**Tape dimensions**

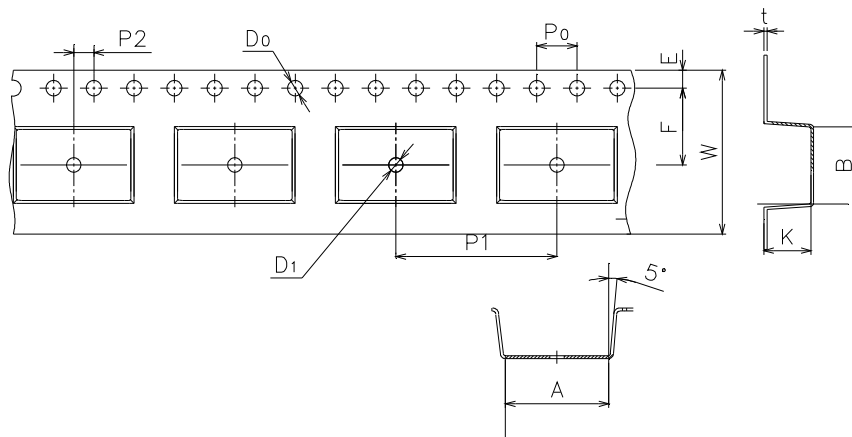

Dimension No.	A	B	Do	D1	E	F
Dimension (mm)	10.4±0.1	7.5±0.1	1.5±0.1	1.5+0.1/-0	1.75±0.1	7.5±0.1

Dimension No.	P0	P1	P2	t	W	K
Dimension (mm)	4.0±0.15	12±0.1	2.0±0.1	0.35±0.03	16.0±0.2	4.5±0.1

## Precautions for Use

### 1. Soldering Condition

#### 1.1 (A) Maximum Body Case Temperature Profile for evaluation of Reflow Profile

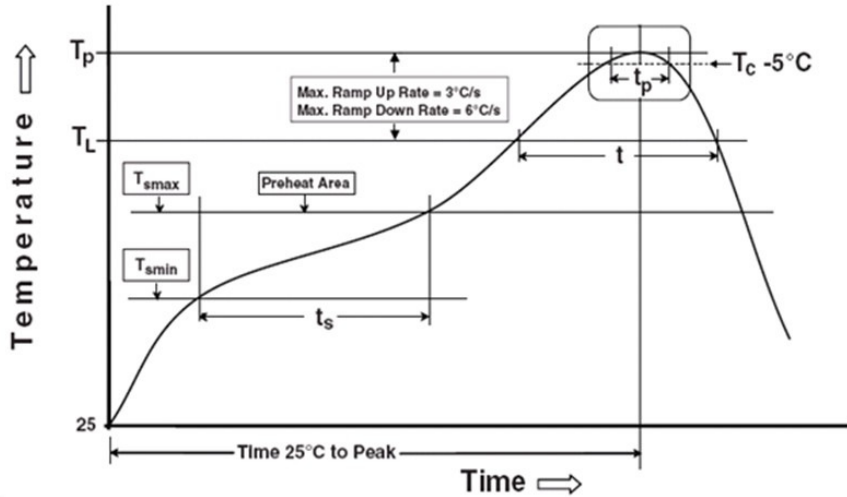

Note:

Reference: IPC/JEDEC J-STD-020D

#### Preheat

Temperature min ( $T_{smin}$ )	150 °C
Temperature max ( $T_{smax}$ )	200 °C
Time ( $T_{smin}$ to $T_{smax}$ ) ( $t_s$ )	60-120 seconds
Average ramp-up rate ( $T_{smax}$ to $T_p$ )	3 °C/second max

#### Other



Liquidus Temperature ( $T_L$ )	217 °C
Time above Liquidus Temperature ( $t_L$ )	60-100 sec
Peak Temperature ( $T_p$ )	260 °C
Time within 5 °C of Actual Peak Temperature: $T_p - 5^\circ\text{C}$	30 s
Ramp- Down Rate from Peak Temperature	6 °C /second max.
Time 25 °C to peak temperature	8 minutes max.
Reflow times	3 times

## **DISCLAIMER**

1. Above specification may be changed without notice. EVERLIGHT will reserve authority on material change for above specification.
2. When using this product, please observe the absolute maximum ratings and the instructions for using outlined in these specification sheets. EVERLIGHT assumes no responsibility for any damage resulting from use of the product which does not comply with the absolute maximum ratings and the instructions included in these specification sheets.
3. These specification sheets include materials protected under copyright of EVERLIGHT corporation. Please don't reproduce or cause anyone to reproduce them without EVERLIGHT's consent.

## Looking for pricing, stock, or lifecycle information?

Click below to explore more details on WIN SOURCE:

-  [View EL3061 on WIN SOURCE](#)
-  [Everlight Electronics Co Ltd Information](#)

## Optimize Your Supply Chain with WIN SOURCE Solutions

-  Global Sourcing Solution
-  Obsolete Management
-  Cost Control Management
-  Shortage Management
-  Alternative Solution
-  Excess Inventory Management