



**THE DATASHEET OF
AD9878BSTZ**



TABLE OF CONTENTS

Electrical Characteristics	4	Transmit Timing.....	21
Absolute Maximum Ratings.....	7	Interpolation Filter	21
Explanation of Test Levels.....	7	Half-Band Filters (HBFs)	21
Thermal Characteristics	7	Cascade Integrator Comb (CIC) Filter.....	21
ESD Caution.....	7	Combined Filter Response.....	21
Pin Configuration and Function Descriptions.....	8	Digital Upconverter	22
Typical Performance Characteristics	10	Tx Signal Level Considerations.....	22
Terminology	13	Tx Throughput and Latency.....	23
Register Bit Definitions.....	14	DAC.....	23
Register 0x00—Initialization	15	Programming the AD8321/AD8323 or AD8322/AD8327/AD8238 Cable-Driver Amplifiers.....	23
Register 0x01—Clock Configuration.....	15	OSCIN Clock Multiplier	24
Register 0x02—Power-Down.....	15	Clock and Oscillator Circuitry	24
Register 0x03—Flag Control.....	15	Programmable Clock Output REFCLK	24
Register 0x04— Σ - Δ Control Word.....	15	Power-Up Sequence	26
Register 0x07—Video Input Configuration.....	16	Reset	26
Register 0x08—ADC Clock Configuration	16	Transmit Power-Down	26
Register 0x0C—Die Revision.....	16	Σ - Δ Outputs	27
Register 0x0D—Tx Frequency Tuning Words LSBs.....	16	Receive Path (Rx)	27
Register 0x0E—DAC Gain Control	16	IF10 and IF12 ADC Operation	27
Register 0x0F—Tx Path Configuration	16	ADC Voltage References	29
Registers 0x10 Through 0x17—Burst Parameter.....	17	Video Input	29
Serial Interface for Register Control	18	PCB Design Considerations.....	30
General Operation of the Serial Interface	18	Component Placement.....	30
Instruction Byte	18	Power Planes and Decoupling	30
Serial Interface Port Pin Descriptions	18	Ground Planes	30
MSB/LSB Transfers.....	19	Signal Routing.....	30
Notes on Serial Port Operation	19	Outline Dimensions	36
Theory of Operation	20	Ordering Guide	36
Transmit Path.....	21		
Data Assembler.....	21		

REVISION HISTORY

3/05—Rev. 0 to Rev. A

Changed OSCOUT to REFCLK..... Universal
Changes to Electrical Characteristics4
Changes to Pin Configuration and Function Descriptions.....8
Changes to Σ - Δ Output Signals (Figure 32).....27
Change to Σ - Δ RC Filter (Figure 33)27
Changes to Evaluation PCB Schematic (Figure 38 and Figure 39).....31
Updated Outline Dimensions.....36
Changes to Ordering Guide.....36

5/03—Revision 0: Initial Version

ELECTRICAL CHARACTERISTICS

$V_{AS} = 3.3 \text{ V} \pm 5\%$, $V_{DS} = 3.3 \text{ V} \pm 10\%$, $f_{OSCIN} = 27 \text{ MHz}$, $f_{SYSCLK} = 216 \text{ MHz}$, $f_{MCLK} = 54 \text{ MHz}$ ($M = 8$), ADC clock derived from OSCIN, $R_{SET} = 4.02 \text{ k}\Omega$, maximum. Fine gain, $75 \text{ }\Omega$ DAC load.

Table 1.

PARAMETER	Temp	Test Level	Min	Typ	Max	Unit
OSCIN and XTAL CHARACTERISTICS						
Frequency Range	Full	II	3		29	MHz
Duty Cycle	25°C	II	35	50	65	%
Input Impedance	25°C	III		100 3		M Ω pF
MCLK Cycle-to-Cycle Jitter (f_{MCLK} derived from PLL)	25°C	III		6		ps rms
Tx DAC CHARACTERISTICS						
Maximum Sample Rate	Full	II	232			MHz
Resolution	N/A	N/A		12		Bits
Full-Scale Output Current	Full	II	4	10	20	mA
Gain Error (Using Internal Reference)	25°C	I	-2.0	-1	+2.0	% FS
Offset Error	25°C	I		± 1.0		% FS
Reference Voltage (REFIO Level)	25°C	I	1.18	1.23	1.28	V
Differential Nonlinearity (DNL)	25°C	III		± 2.5		LSB
Integral Nonlinearity (INL)	25°C	III		± 8		LSB
Output Capacitance	25°C	III		5		pF
Phase Noise @ 1 kHz Offset, 42 MHz Carrier	25°C	III		-110		dBc/Hz
Output Voltage Compliance Range	Full	II	-0.5		+1.5	V
Wideband SFDR						
5 MHz Analog Output, $I_{OUT} = 10 \text{ mA}$	Full	II	62.4	68		dB
65 MHz Analog Output, $I_{OUT} = 10 \text{ mA}$	Full	II	50.3	53.5		dB
Narrow-Band SFDR ($\pm 1 \text{ MHz}$ Window)						
5 MHz Analog Output, $I_{OUT} = 10 \text{ mA}$	Full	II	71	74		dB
65 MHz Analog Output, $I_{OUT} = 10 \text{ mA}$	Full	II	61	64		dB
Tx MODULATOR CHARACTERISTICS						
I/Q Offset	Full	II	50	55		dB
Pass-Band Amplitude Ripple ($f < f_{IQCLK}/8$)	Full	II			± 0.1	dB
Pass-Band Amplitude Ripple ($f < f_{IQCLK}/4$)	Full	II			± 0.5	dB
Stop-Band Response ($f > f_{IQCLK} \times 3/4$)	Full	II			-63	dB
Tx GAIN CONTROL						
Gain Step Size	25°C	III		0.5		dB
Gain Step Error	25°C	III		<0.05		dB
Settling Time, 1% (Full-Scale Step)	25°C	III		1.8		μs
10-BIT ADC CHARACTERISTICS						
Resolution	N/A	N/A		10		Bits
Maximum Conversion Rate	Full	II	29			MHz
Pipeline Delay	N/A	N/A		4.5		ADC cycles
Analog Input						
Input Voltage Range	Full	II		2		V_{PPD}
Differential Input Impedance	25°C	III		4 2		k Ω pF
Full Power Bandwidth	25°C	III		90		MHz
Dynamic Performance ($A_{IN} = -0.5 \text{ dBFS}$, $f = 5 \text{ MHz}$)						
Signal-to-Noise and Distortion (SINAD)	Full	II	57.6	59.7		dB
Effective Number of Bits (ENOB)	Full	II	9.3	9.6		Bits
Total Harmonic Distortion (THD)	Full	II		-71.1	-63.6	dB
Spurious-Free Dynamic Range (SFDR)	Full	II	65.7	72.4		dB
Reference Voltage Error, REFT10 to REFB10 (1.0 V)	Full	I		± 4	± 100	mV

PARAMETER	Temp	Test Level	Min	Typ	Max	Unit
Dynamic Performance ($A_{IN} = -0.5$ dBFS, $f = 50$ MHz)						
Signal-to-Noise and Distortion (SINAD)	Full	II	54.8	57.8		dB
Effective Number of Bits (ENOB)	Full	II	8.8	9.3		Bits
Total Harmonic Distortion (THD)	Full	II		-63.3	-56.9	dB
Spurious-Free Dynamic Range (SFDR)	Full	II	56.9	63.7		dB
12-BIT ADC CHARACTERISTICS						
Resolution	N/A	N/A		12		Bits
Maximum Conversion Rate	Full	II	29			MHz
Pipeline Delay	N/A	N/A		5.5		ADC cycles
Analog Input						
Input Voltage Range	Full	III		2		V_{PPD}
Differential Input Impedance	25°C	III		4 2		$k\Omega pF$
Aperture Delay	25°C	III		2.0		ns
Aperture Jitter	25°C	III		1.2		ps rms
Full Power Bandwidth	25°C	III		85		MHz
Input Referred Noise	25°C	III		75		μV
Reference Voltage Error, REFT12 to REFB12 (1 V)	Full	I	-100	± 16	+100	mV
Dynamic Performance ($A_{IN} = -0.5$ dBFS, $f = 5$ MHz)						
ADC Sample Clock = OSCIN						
Signal-to-Noise and Distortion (SINAD)	Full	II	61.0	67		dB
Effective Number of Bits (ENOBs)	Full	II	9.8	10.8		Bits
Signal-to-Noise Ratio (SNR)	Full	II	64.2	66		dB
Total Harmonic Distortion (THD)	Full	II		-72.7	-61.7	dB
Spurious-Free Dynamic Range (SFDR)	Full	II	62.8	74.6		dB
ADC Sample Clock = PLL						
Signal-to-Noise and Distortion (SINAD)	Full	II	60.4	64.4		dB
Effective Number of Bits (ENOB)	Full	II	9.74	10.4		Bits
Signal-to-Noise Ratio (SNR)	Full	II	62.4	65.1		dB
Total Harmonic Distortion (THD)	Full	II		-72.7	-61.8	dB
Spurious-Free Dynamic Range (SFDR)	Full	II	62.7	74.6		dB
Dynamic Performance ($A_{IN} = -0.5$ dBFS, $f = 50$ MHz)						
ADC Sample Clock = OSCIN						
Signal-to-Noise and Distortion (SINAD)	Full	II	61.0	65.2		dB
Effective Number of Bits (ENOB)	Full	II	9.8	10.5		Bits
Signal-to-Noise Ratio (SNR)	Full	II	64.2	67.4		dB
Total Harmonic Distortion (THD)	Full	II		-72.8	-61.8	dB
Spurious-Free Dynamic Range (SFDR)	Full	II	62.8	74.6		dB
Differential Phase	25°C	III		<0.1		Degrees
Differential Gain	25°C	III		<1		LSB
VIDEO ADC PERFORMANCE ($A_{IN} = -0.5$ dBFS, $f = 5$ MHz)						
ADC Sample Clock = OSCIN						
Signal-to-Noise and Distortion (SINAD)	Full	II	46.7	53		dB
Signal-to-Noise Ratio (SNR)	Full	II	54.3	63.2		Bits
Total Harmonic Distortion (THD)	Full	II		-50.2	-45.9	dB
Spurious-Free Dynamic Range (SFDR)	Full	II	45.9	50		dB
CHANNEL-TO-CHANNEL ISOLATION						
Tx DAC-to-ADC Isolation (5 MHz Analog Output)						
Isolation Between Tx and 10-Bit ADC	25°C	III		>60		dB
Isolation Between Tx and 12-Bit ADCs	25°C	III		>80		dB
ADC-to-ADC Isolation ($A_{IN} = -0.5$ dBFS, $f = 5$ MHz)						
Isolation Between IF10 and IF12A/B	25°C	III		>85		dB
Isolation Between IF12A and IF12B	25°C	III		>85		dB

AD9878

PARAMETER	Temp	Test Level	Min	Typ	Max	Unit
TIMING CHARACTERISTICS (10 pF Load)						
Wake-Up Time	N/A	N/A			200	t _{MCLK} cycles
Minimum RESET Pulse Width Low, t _{RL}	N/A	N/A	5			t _{MCLK} cycles
Digital Output Rise/Fall Time	Full	II	2.8		4	ns
Tx/Rx Interface						
MCLK Frequency, f _{MCLK}	Full	II			58	MHz
TxSYNC/TxIQ Setup Time, t _{SU}	Full	II	3			ns
TxSYNC/TxIQ Hold Time, t _{HU}	Full	II	3			ns
MCLK Rising Edge to RxSYNC Valid Delay, t _{MD}	Full	II	0		1.0	ns
REFCLK Rising or Falling Edge to RxSYNC Valid Delay, t _{OD}	Full	II	t _{OSCIN} / 4 – 2.0		t _{OSCIN} / 4 + 3.0	ns
REFCLK Edge to MCLK Falling Edge, t _{EE}	Full	II	–1.0		+1.0	ns
SERIAL CONTROL BUS						
Maximum SCLK Frequency, f _{SCLK}	Full	II			15	MHz
Minimum Clock Pulse Width High, t _{PWH}	Full	II	30			ns
Minimum Clock Pulse Width Low, t _{PWL}	Full	II	30			ns
Maximum Clock Rise/Fall Time	Full	II			1	μs
Minimum Data/Chip-Select Setup Time, t _{DS}	Full	II	25			ns
Minimum Data Hold Time, t _{DH}	Full	II	0			ns
Maximum Data Valid Time, t _{DV}	Full	II			30	ns
CMOS LOGIC INPUTS						
Logic 1 Voltage	25°C	II	V _{DRVDD} – 0.7			V
Logic 0 Voltage	25°C	II			0.4	V
Logic 1 Current	25°C	II			12	μA
Logic 0 Current	25°C	II			12	μA
Input Capacitance	25°C	III		3		pF
CMOS LOGIC OUTPUTS (1 mA Load)						
Logic 1 Voltage	25°C	II	V _{DRVDD} – 0.6			V
Logic 0 Voltage	25°C	II			0.4	V
POWER SUPPLY						
Supply Current, I _S (Full Operation)	25°C	II		184	204	mA
Analog Supply Current, I _{AS}	25°C	III		105	115	mA
Digital Supply Current, I _{DS}	25°C	III		79	89	mA
Supply Current, I_S						
Standby (PWRDN Pin Active, I _{AS} + I _{DS})	25°C	II		124	137	mA
Full Power-Down (Register 0x02 = 0xFF)	25°C	II		46	52	mA
Power-Down Tx Path (Register 0x02 = 0x60)	25°C	III		124		mA
Power-Down IF12 Rx Path (Register 0x02 = 0x1B)	25°C	III		131	159	mA
Power Supply Rejection (Differential Signal)						
Tx DAC	25°C	III		<0.25		% FS
10-Bit ADC	25°C	III		<0.0001		% FS
12-Bit ADC	25°C	III		<0.0004		% FS

ABSOLUTE MAXIMUM RATINGS

Table 2.

Parameter	Rating
Power Supply (V_{AVDD} , V_{DVDD} , V_{DRVDD})	3.9 V
Digital Output Current	5 mA
Digital Inputs	-0.3 V to $V_{DRVDD} + 0.3$ V
Analog Inputs	-0.3 V to $V_{AVDD} + 0.3$ V
Operating Temperature	-40°C to +85°C
Maximum Junction Temperature	150°C
Storage Temperature	-65°C to +150°C
Lead Temperature (Soldering, 10 sec)	300°C

Stresses above those listed under Absolute Maximum Ratings may cause permanent damage to the device. This is a stress rating only; functional operation of the device at these or any other conditions above those indicated in the operational section of this specification is not implied. Exposure to absolute maximum rating conditions for extended periods may affect device reliability.

EXPLANATION OF TEST LEVELS

- I. Devices are 100% production tested at 25°C and guaranteed by design and characterization testing for extended industrial operating temperature range (-40°C to +85°C).
 - II. Parameter is guaranteed by design and/or characterization testing.
 - III. Parameter is a typical value only.
- N/A. Test level definition is not applicable.

THERMAL CHARACTERISTICS

Thermal resistance of 100-lead LQFP: $\theta_{JA} = 40.5^{\circ}\text{C}/\text{W}$

ESD CAUTION

ESD (electrostatic discharge) sensitive device. Electrostatic charges as high as 4000 V readily accumulate on the human body and test equipment and can discharge without detection. Although this product features proprietary ESD protection circuitry, permanent damage may occur on devices subjected to high energy electrostatic discharges. Therefore, proper ESD precautions are recommended to avoid performance degradation or loss of functionality.



Pin No.	Mnemonic	Descriptions
44	SDO	SPORT Data Output
45	DGNDTx	Tx Path Digital Ground
46	DVDDTx	Tx Path Digital 3.3 V Supply
47	PWRDN	Power-Down Transmit Path
48	REFIO	TxDAC Decoupling (to AGND)
49	FSADJ	DAC Output Adjust (External Resistor)
50	AGNDTx	Tx Path Analog Ground
51, 52	Tx-, Tx+	Tx Path Complementary Outputs
53	AVDDTx	Tx Path Analog 3.3 V Supply
54	DGNDPLL	PLL Digital Ground
55	DVDDPLL	PLL Digital 3.3 V Supply
56	AVDDPLL	PLL Analog 3.3 V Supply
57	PLLFILT	PLL Loop Filter Connection
58	AGNDPLL	PLL Analog Ground
59	DGNDOSC	Oscillator Digital Ground
60	XTAL	Crystal Oscillator Inverted Output
61	OSCIN	Oscillator Clock Input
62	DVDDOSC	Oscillator Digital 3.3 V Supply
63	CA_CLK	Serial Clock-to-Cable Driver
64	CA_DATA	Serial Data-to-Cable Driver
65	CA_EN	Serial Enable-to-Cable Driver
66, 67	FLAG[2:1]	Programmable Flag Outputs
68	SIGDELT	Σ - Δ DAC Output
69	REFCLK	Reference Clock Output
72, 80	AVDD10	10-Bit ADC Analog 3.3 V Supply
73, 79	AGND10	10-Bit ADC Analog Ground
74	REFB10	10-Bit ADC Reference Decoupling Node
75	REFT10	10-Bit ADC Reference Decoupling Node
76, 81, 86, 89, 94, 97, 99	AGND	12-Bit ADC Analog Ground
77, 78	IF10-, IF10+	Differential Input to 10-bit ADC
82, 85, 90, 93, 100	AVDD	12-Bit ADC Analog 3.3 V Supply
83	REFB12B	ADC12B Reference Decoupling Node
84	REFT12B	ADC12B Reference Decoupling Node
87, 88	IF12B-, IF12B+	Differential Input to ADC12B
91	REFB12A	ADC12A Reference Decoupling Node
92	REFT12A	ADC12A Reference Decoupling Node
95, 96	IF12A-, IF12A+	Differential Input to ADC12A
98	VIDEO IN	Video Clamp Input

TYPICAL PERFORMANCE CHARACTERISTICS

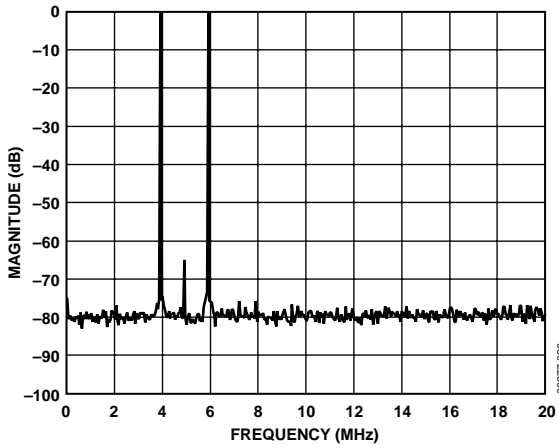

Figure 3. Dual-Sideband Spectral Plot, $f_c = 5$ MHz, $f = 1$ MHz, $R_{SET} = 10$ k Ω ($I_{OUT} = 4$ mA), RBW = 1 kHz

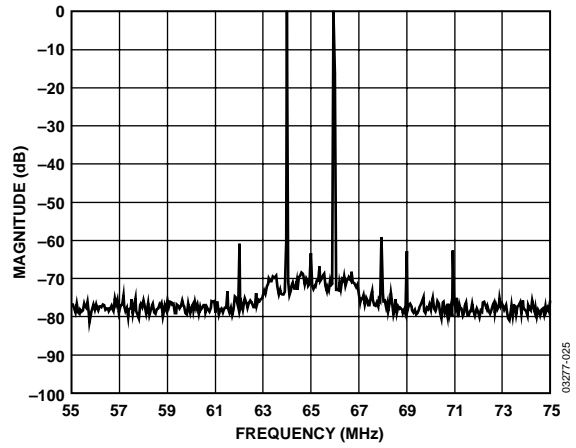

Figure 6. Dual-Sideband Spectral Plot, $f_c = 65$ MHz, $f = 1$ MHz, $R_{SET} = 4$ k Ω ($I_{OUT} = 10$ mA), RBW = 1 kHz

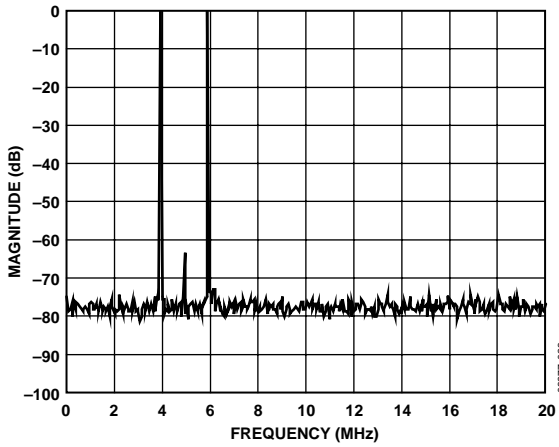

Figure 4. Dual-Sideband Spectral Plot, $f_c = 5$ MHz, $f = 1$ MHz, $R_{SET} = 4$ k Ω ($I_{OUT} = 10$ mA), RBW = 1 kHz

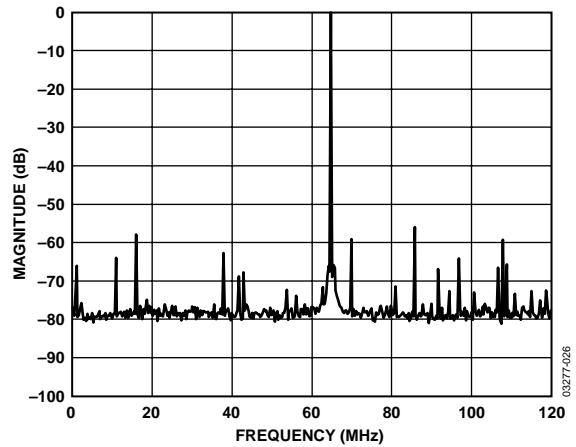

Figure 7. Single Sideband @ 65 MHz, $f_c = 66$ MHz, $f = 1$ MHz, $R_{SET} = 10$ k Ω ($I_{OUT} = 4$ mA), RBW = 2 kHz

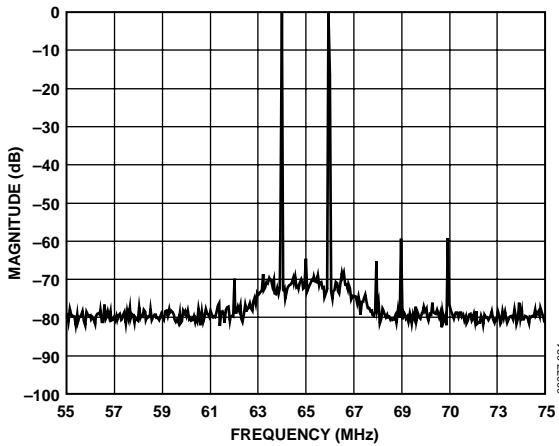

Figure 5. Dual-Sideband Spectral Plot, $f_c = 65$ MHz, $f = 1$ MHz, $R_{SET} = 10$ k Ω ($I_{OUT} = 4$ mA), RBW = 1 kHz

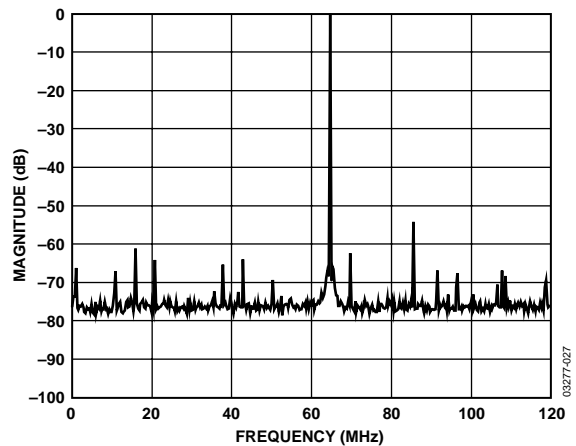

Figure 8. Single Sideband @ 65 MHz, $f_c = 66$ MHz, $f = 1$ MHz, $R_{SET} = 4$ k Ω ($I_{OUT} = 10$ mA), RBW = 2 kHz

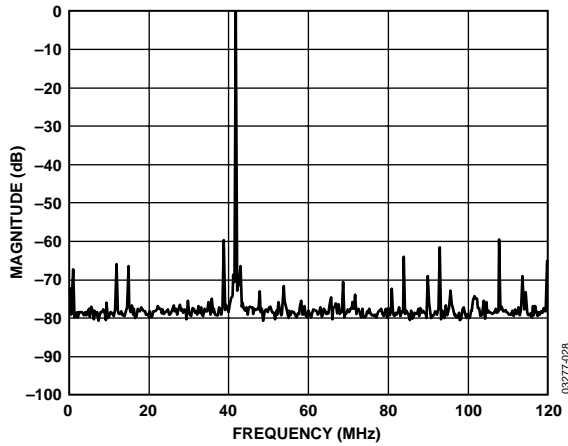

Figure 9. Single Sideband @ 42 MHz, $f_c = 43$ MHz, $f = 1$ MHz, $R_{SET} = 10$ k Ω ($I_{OUT} = 4$ mA), $RBW = 2$ kHz

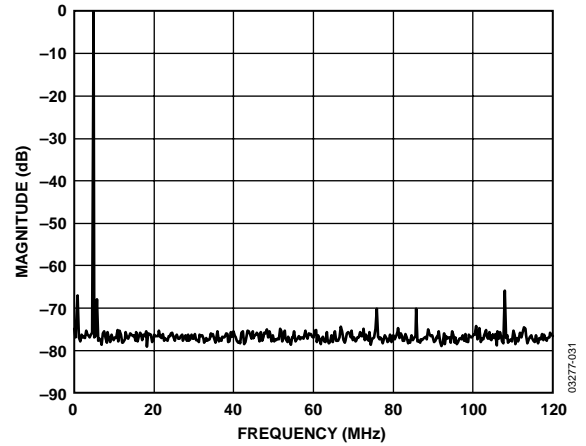

Figure 12. Single Sideband @ 5 MHz, $f_c = 6$ MHz, $f = 1$ MHz, $R_{SET} = 4$ k Ω ($I_{OUT} = 10$ mA), $RBW = 2$ kHz

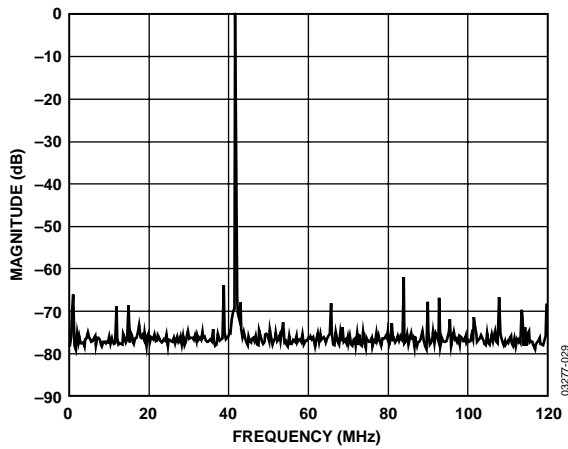

Figure 10. Single Sideband @ 42 MHz, $f_c = 43$ MHz, $f = 1$ MHz, $R_{SET} = 4$ k Ω ($I_{OUT} = 10$ mA), $RBW = 2$ kHz

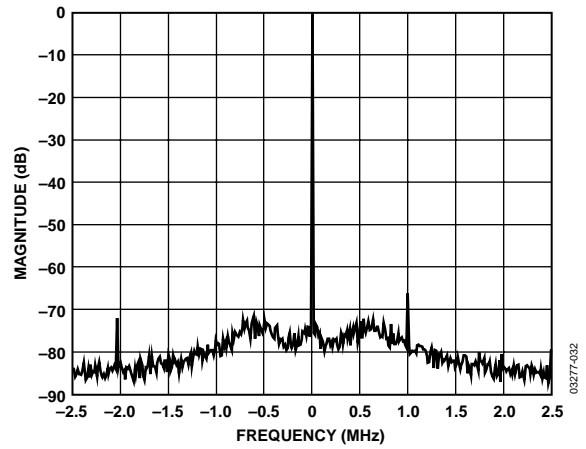

Figure 13. Single Sideband @ 65 MHz, $f_c = 66$ MHz, $f = 1$ MHz, $R_{SET} = 10$ k Ω ($I_{OUT} = 4$ mA), $RBW = 500$ Hz

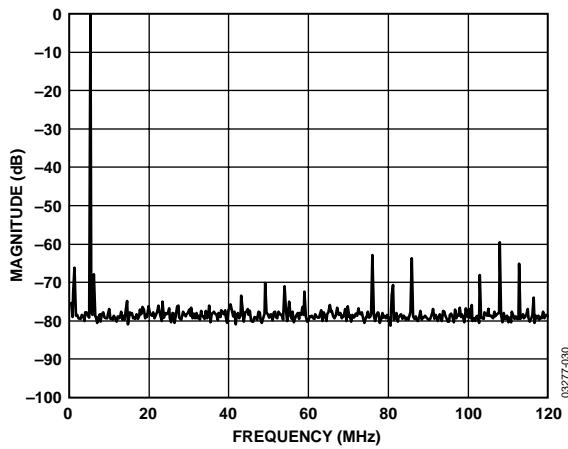

Figure 11. Single Sideband @ 5 MHz, $f_c = 6$ MHz, $f = 1$ MHz, $R_{SET} = 10$ k Ω ($I_{OUT} = 4$ mA), $RBW = 2$ kHz

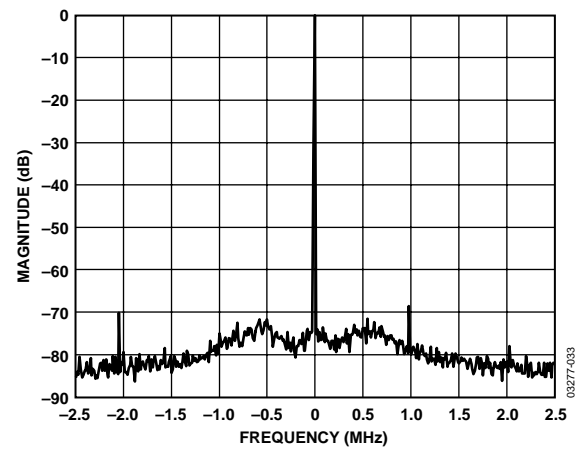

Figure 14. Single Sideband @ 65 MHz, $f_c = 66$ MHz, $f = 1$ MHz, $R_{SET} = 4$ k Ω ($I_{OUT} = 10$ mA), $RBW = 500$ Hz

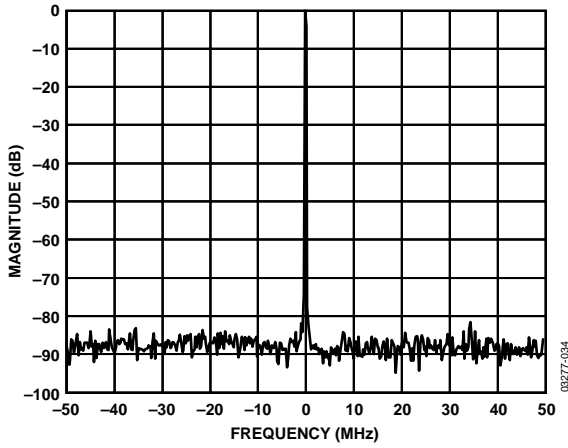

Figure 15. Single Sideband @ 65 MHz, $f_c = 66$ MHz, $f = 1$ MHz, $R_{SET} = 10$ k Ω ($I_{OUT} = 4$ mA), $RBW = 50$ Hz

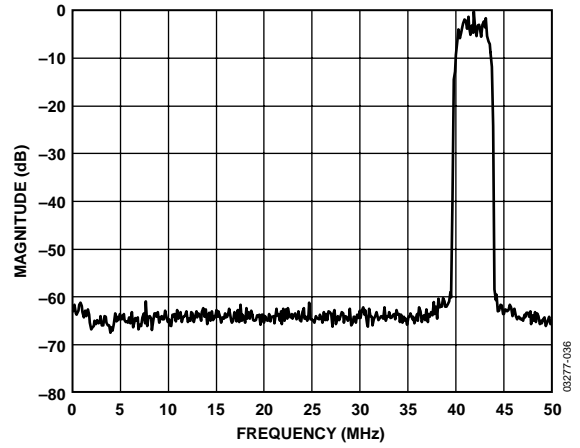

Figure 17. 16-QAM @ 42 MHz Spectral Plot, $RBW = 1$ kHz

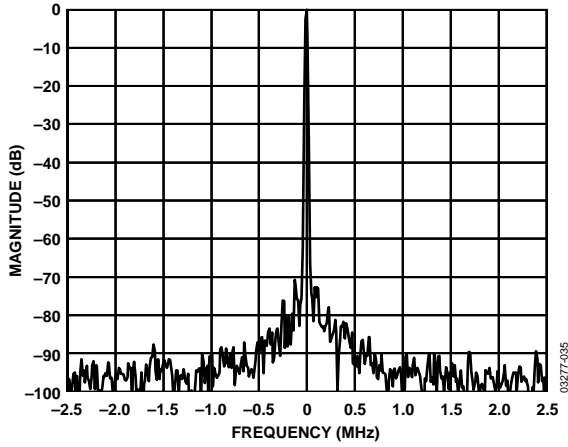

Figure 16. Single Sideband @ 65 MHz, $f_c = 66$ MHz, $f = 1$ MHz, $R_{SET} = 10$ k Ω ($I_{OUT} = 4$ mA), $RBW = 10$ Hz

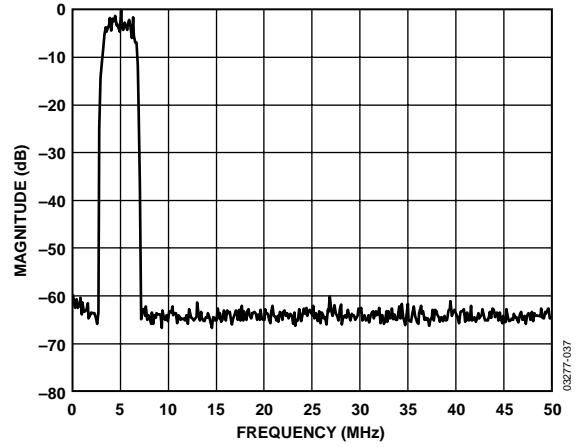

Figure 18. 16-QAM @ 5 MHz Spectral Plot, $RBW = 1$ kHz

TERMINOLOGY

Differential Nonlinearity Error (DNL, No Missing Codes)

An ideal converter exhibits code transitions that are exactly 1 LSB apart. DNL is the deviation from this ideal value. No missing codes indicates that all of the ADC codes must be present over all operating ranges.

Integral Nonlinearity Error (INL)

Linearity error refers to the deviation of each individual code from a line drawn from negative full scale through positive full scale. The point used as negative full scale occurs $\frac{1}{2}$ LSB before the first code transition. Positive full scale is defined as a level $1\frac{1}{2}$ LSB beyond the last code transition. The deviation is measured from the middle of each code to the true straight line.

Phase Noise

Single-sideband, phase-noise power is specified relative to the carrier (dBc/Hz) at a given frequency offset (1 kHz) from the carrier. Phase noise can be measured directly in single-tone transmit mode with a spectrum analyzer that supports noise marker measurements. It detects the relative power between the carrier and the offset (1 kHz) sideband noise and takes the resolution bandwidth (RBW) into account by subtracting $10 \times \log(\text{RBW})$. It also adds a correction factor that compensates for the implementation of the resolution bandwidth, log display, and detector characteristic.

Output Compliance Range

The range of allowable voltage at the output of a current-output DAC. Operation beyond the maximum compliance limits can cause either output stage saturation or breakdown, resulting in nonlinear performance.

Spurious-Free Dynamic Range (SFDR)

The difference, in dB, between the rms amplitude of the DAC output signal (or ADC input signal) and the peak spurious signal over the specified bandwidth (Nyquist bandwidth, unless otherwise noted).

Pipeline Delay (Latency)

The number of clock cycles between conversion initiation and the associated output data being made available.

Offset Error

The first code transition should occur at an analog value $\frac{1}{2}$ LSB above negative full scale. Offset error is defined as the deviation of the actual transition from that point.

Gain Error

The first code transition should occur at an analog value $\frac{1}{2}$ LSB above negative full scale. The last transition should occur for an analog value $1\frac{1}{2}$ LSB below the nominal full scale. Gain error is the deviation of the actual difference between first and last code transitions and the ideal difference between first and last code transitions.

Aperture Delay

The aperture delay is a measure of the sample-and-hold amplifier (SHA) performance that specifies the time delay between the rising edge of the sampling clock input and when the input signal is held for conversion.

Aperture Jitter

Aperture jitter is the variation in aperture delay for successive samples and is manifested as noise on the input to the ADC.

Input Referred Noise

The rms output noise is measured using histogram techniques. The standard deviation of the ADC output codes is calculated in LSB, and converted to an equivalent voltage. This results in a noise figure that can be directly referred to the input of the MxFE.

Signal-to-Noise and Distortion (SINAD) Ratio

SINAD is the ratio of the rms value of the measured input signal to the rms sum of other spectral components below the Nyquist frequency, including harmonics, but excluding dc. The value for SINAD is expressed in decibels.

Effective Number of Bits (ENOB)

For a sine wave, SINAD can be expressed in terms of the number of bits. Using the following formula, it is possible to get a measure of performance expressed as N , the effective number of bits:

$$N = (\text{SINAD} - 1.76) \text{ dB} / 6.02$$

Thus, the effective number of bits for a device for sine wave inputs at a given input frequency can be calculated directly from its measured SINAD.

Signal-to-Noise Ratio (SNR)

SNR is the ratio of the rms value of the measured input signal to the rms sum of other spectral components below the Nyquist frequency, excluding harmonics and dc. The value for SNR is expressed in decibels.

Total Harmonic Distortion (THD)

THD is the ratio of the rms sum of the first six harmonic components to the rms value of the measured input signal. It is expressed as a percentage, or in decibels.

Power Supply Rejection

Power supply rejection specifies the converter's maximum full-scale change when the supplies are varied from nominal to minimum or maximum specified voltages.

Channel-to-Channel Isolation (Crosstalk)

In an ideal multichannel system, the signal in one channel does not influence the signal level of another channel. The channel-to-channel isolation specification is a measure of the change that occurs in a grounded channel as a full-scale signal is applied to another channel.

REGISTER BIT DEFINITIONS

Table 4. Register Map

Address (Hex)	Bit 7	Bit 6	Bit 5	Bit 4	Bit 3	Bit 2	Bit 1	Bit 0	Default (Hex)	Type
0x00	SDIO bidirectional	LSB first	Reset	OSCIN multiplier M[4:0]					0x08	Read/write
0x01	PLL lock detect		MCLK divider R[5:0]					0x00	Read/write	
0x02	Power down PLL	Power down DAC Tx	Power down digital Tx	Power down ADC12A	Power down ADC12B	Power down ADC10	Power down reference ADC12A	Power down reference ADC12B	0x00	Read/write
0x03			Video input into ADC12B	Flag 2			Flag 1	Flag 0 enable	0x00	Read/write
0x04	MSB/Flag 0	Σ-Δ output control word [7:0]					0x00	Read/write		
0x05									0x00	Read/write
0x06									0x00	Read only
0x07	Video input enable	Clamp level for video input [6:0]					0x00	Read/write		
0x08	ADC clocked directly from OSCIN		Rx port fast edge rate	Power down RxSYNC generator	Power down reference ADC10		Send ADC12A data only	Send ADC12B data only	0x80	Read/write
0x09									0x00	Read/write
0x0A									0x00	Read/write
0x0B									0x00	Read/write
0x0C					Version [3:0]			0x00	Read/write	
0x0D					Tx frequency tuning word profile 1 LSB [1:0]		Tx frequency tuning word profile 0 LSBs [1:0]		0x00	Read/write
0x0E					DAC fine gain control [3:0]			0x00	Read/write	
0x0F			Tx path select Profile 1		Tx path AD8321/AD8323 gain control mode	Tx path bypass sinc ⁻¹ filter	Tx path spectral inversion	Tx path transmit single tone	0x00	Read/write
0x10	Tx Path Frequency Tuning Word Profile 0 [9:2]								0x00	Read/write
0x11	Tx Path Frequency Tuning Word Profile 0 [17:10]								0x00	Read/write
0x12	Tx Path Frequency Tuning Word Profile 0 [25:18]								0x00	Read/write
0x13	Cable-driver amplifier, Coarse Gain Control Profile 0 [7:4]				Cable-driver amplifier, Fine Gain Control Profile 0 [3:0]				0x00	Read/write
0x14	Tx Path Frequency Tuning Word Profile 1 [9:2]								0x00	Read/write
0x15	Tx Path Frequency Tuning Word Profile 1 [17:10]								0x00	Read/write
0x16	Tx Path Frequency Tuning Word Profile 1 [25:18]								0x00	Read/write
0x17	Cable-driver amplifier, Coarse Gain Control Profile 1 [7:4]				Cable-driver amplifier, Fine Gain Control Profile 1 [3:0]				0x00	Read/write

REGISTER 0x00—INITIALIZATION**Bits 0 to 4: OSCIN Multiplier**

This register field is used to program the on-chip clock multiplier that generates the chip's high frequency system clock, f_{SYSCLK} . For example, to multiply the external crystal clock f_{OSCIN} by 16, program Register 0x00, Bits 4:0, to 0x10. The default clock multiplier value, M , is 0x08. Valid entries range from 1 to 31. When M is set to 1, the PLL is disabled and internal clocks are derived directly from OSCIN. The PLL requires 200 MCLK cycles to regain frequency lock after a change in M . After the recapture time of the PLL, the frequency of f_{SYSCLK} is stable.

Bit 5: Reset

Writing 1 to this bit resets the registers to their default values and restarts the chip. The reset bit always reads back 0. The bits in Register 0x00 are not affected by this software reset. However, a low level at the RESET pin forces all registers, including all bits in Register 0x00, to their default states.

Bit 6: LSB First

Active high indicates SPI serial port access of instruction byte and data registers is LSB first. Default low indicates MSB-first format.

Bit 7: SDIO Bidirectional

Active high configures the serial port as a 3-signal port with the SDIO pin used as a bidirectional input/output pin. Default low indicates that the serial port uses four signals with SDIO configured as an input and SDO configured as an output.

REGISTER 0x01—CLOCK CONFIGURATION**Bits [5:0]: MCLK Divider**

This register determines the output clock on the REFCLK pin. At default 0 ($R = 0$), REFCLK provides a buffered version of the OSCIN clock signal for other chips. The register can also be used to divide the chip's master clock f_{MCLK} by R , where R is an integer between 2 and 63. The generated reference clock on REFCLK pin can be used for external frequency controlled devices.

Bit 7: PLL Lock Detect

When this bit is set low, the REFCLK pin functions in its default mode and provides an output clock with frequency f_{MCLK}/R , as described above. If this bit is set to 1, the REFCLK pin is configured to indicate whether the PLL is locked to f_{OSCIN} . In this mode, the REFCLK pin should be low-pass filtered with an RC filter of 1.0 k Ω and 0.1 μF . A low output on REFCLK indicates that the PLL has achieved lock with f_{OSCIN} .

REGISTER 0x02—POWER-DOWN

Unused sections of the chip can be powered down when the corresponding bits are set high. This register has a default value of 0x00, all sections active.

Bit 0: Power Down ADC12B Voltage Reference

Active high powers down the voltage reference circuit for ADC12B.

Bit 1: Power Down ADC12A Voltage Reference

Active high powers down the voltage reference circuit for the ADC12A.

Bit 2: Power Down ADC10

Active high powers down the 10-bit ADC.

Bit 3: Power Down ADC12B

Active high powers down the ADC12B.

Bit 4: Power Down ADC12A

Active high powers down the ADC12A.

Bit 5: Power Down Tx

Active high powers down the digital transmit section of the chip, similar to the function of the PWRDN pin.

Bit 6: Power Down DAC Tx

Active high powers down the DAC.

Bit 7: Power Down PLL

Active high powers down the OSCIN multiplier.

REGISTER 0x03—FLAG CONTROL**Bit 0: Flag 0 Enable**

When this bit is active high, the SIGDELT pin maintains a fixed logic level determined directly by the MSB of the Σ - Δ control word of Register 0x04.

Bit 1: Flag 1

The logic level of this bit is applied at the FLAG1 pin.

Bit 4: Flag 2

The logic level of this bit is applied at the FLAG2 pin.

Bit 5: Video Input into ADC12B

If the video input is enabled, setting this bit high sends the signal applied to the VIDEO IN pin to the ADC12B. Otherwise, the signal applied to the VIDEO IN pin is sent to the ADC12A.

REGISTER 0x04— Σ - Δ CONTROL WORD**Bits [7:0]: Σ - Δ Control Word**

The Σ - Δ control word is 8 bits wide and controls the duty cycle of the digital output on the SIGDELT pin. Changes to the Σ - Δ control word take effect immediately for every register write. Σ - Δ output control words have a default value of 0. The control words are in straight binary format, with 0x00 corresponding to the bottom of scale or 0% duty cycle, and 0xFF corresponding to the top of scale or near 100% duty cycle.

Bit 7: Flag 0 (Σ - Δ Control Word MSB)

When the Flag 0 enable bit (Register 0x03, Bit 0) is set, the logic level of this bit appears on the output of the SIGDELT pin.

REGISTER 0x07—VIDEO INPUT CONFIGURATION

Bits [6:0]: Clamp Level Control Value

The 7-bit clamp-level control value is used to set an offset to the automatic clamp-level control loop. The actual ADC output has a clamp-level offset equal to 16 times the clamp level control value.

$$\text{Clamp - Level Offset} = \text{Clamp - Level Control Value} \times 16$$

The default value for the clamp-level control value is 0x20. This results in an ADC output clamp-level offset of 512 LSBs. The valid programming range for the clamp-level control value is 0x16 to 0x127.

Bit 7: Video Input Enable

This bit enables the video input. In default with Bit 7 = 0, both IF12 ADCs are connected to IF inputs. If the video input is enabled by setting bit 7 = 1, the video input will be connected to the IF12 ADC selected by REG 0x03, Bit 6.

REGISTER 0x08—ADC CLOCK CONFIGURATION

Bit 0: Send ADC12B Data Only

When this bit is set high, the device enters a nonmultiplexed mode, and only the data from the ADC12B is sent to the IF[11:0] digital output port.

Bit 1: Send ADC12A Data Only

When this bit is set high, the device enters a nonmultiplexed mode, and only the data from the ADC12A is sent to the IF[11:0] digital output port.

If both the send ADC12B data only and send ADC12A data only register bits are set high, the device sends both ADC12A and ADC12B data in the default multiplexed mode.

Bit 3: Power Down ADC10 Voltage Reference

Active high powers down the voltage reference circuit for the ADC10.

Bit 4: Power Down RxSYNC Generator

Setting this bit to 1 powers down the 10-bit ADC's sampling clock and makes the RxSYNC output pin stay low. It can be used for additional power saving on top of the power-down selections in Register 0x02.

Bit 5: Rx PORT Fast Edge Rate

Setting this bit to 1 increases the output drive strength of all digital output pins, except MCLK, REFCLK, SIGDELT, and FLAG[2:1]. These pins always have high output drive capability.

Bit 7: ADC Clocked Directly from OSCIN

When set high, the ADC sampling clock is derived directly from the input clock at OSCIN. In this mode, the clock supplied to the OSCIN pin should originate from an external crystal or low jitter crystal oscillator. When this bit is low, the ADC sampling clock is derived from the internal PLL and the frequency of the clock is equal to $f_{\text{OSCIN}} \times M/8$.

REGISTER 0x0C—DIE REVISION

Bits [3:0]: Version

The die version of the chip can be read from this register.

REGISTER 0x0D—Tx FREQUENCY TUNING WORDS LSBs

This register accommodates the 2 LSBs for each frequency tuning word (FTW). See the Registers 0x10 Through 0x17—Burst Parameter section.

REGISTER 0x0E—DAC GAIN CONTROL

This register allows the user to program the DAC gain if the Tx Gain Control Select Bit 3 in Register 0x0F is set to 0.

Table 5. DAC Gain Control

Bits [3:0]	DAC Gain (dB)
0000	0.0 (default)
0001	0.5
0010	1.0
0011	1.5
...	...
1110	7.0
1111	7.5

REGISTER 0x0F—Tx PATH CONFIGURATION

Bit 0: Single Tone Tx Mode

Active high configures the AD9878 for single-tone applications (e.g., FSK). The AD9878 supplies a single frequency output, as determined by the FTW selected by the active profile. In this mode, the TxIQ input data pins are ignored, but should be tied to a valid logic voltage level. Default value is 0x00 (inactive).

Bit 1: Spectral Inversion Tx

When set to 1, inverted modulation is performed:

$$\text{MODULATOR_OUT} = [I \cos(\omega t) + Q \sin(\omega t)].$$

Default is Logic 0, noninverted modulation:

$$\text{MODULATOR_OUT} = [I \cos(\omega t) - Q \sin(\omega t)].$$

Bit 2: Bypass Inv Sinc Tx Filter

Active high configures the AD9878 to bypass the $\sin(x)/x$ compensation filter. Default value is 0x00 (inverse sinc filter enabled).

Bit 3: CA Interface Mode Select

This bit changes the format of the AD9878 3-wire CA interface to a format in which the AD9878 digitally interfaces to external variable gain amplifiers. This is accomplished by changing the interpretation of the bits in Register 0x13, Register 0x17, Register 0x1B, and Register 0x1F. See the Cable-Driver Gain Control section for more detail.

Setting this bit to 0 (default) configures the serial interface to be compatible with AD8321/AD8323/AD8328 variable cable gain amplifiers. Setting this bit to 1 configures the serial interface to be compatible with AD8322/AD8327 variable cable gain amplifiers.

Bit 5: Profile Select

The AD9878 quadrature digital upconverter can store two preconfigured modulation modes, called profiles. Each profile defines a transmit FTW, cable-driver amplifier gain setting, and DAC gain setting. The profile select bit or PROFILE pin programs the current register profile to be used. If the PROFILE pin is used to switch between profiles, the profile select bit should be set to 0 and tied low.

REGISTERS 0x10 THROUGH 0x17—BURST PARAMETER

Tx Frequency Tuning Words

The FTW determines the DDS-generated carrier frequency (f_c) and is formed via a concatenation of register addresses.

The 26-bit FTW is spread over four register addresses. Bit 25 is the MSB, and Bit 0 is the LSB. The carrier frequency equation is as follows:

$$f_c = (FTW \times f_{SYSCLK}) / 2^{26}$$

Where $f_{SYSCLK} = M \times f_{OSCIN}$, and $FTW < 0x2000$.

Changes to FTW bytes take effect immediately.

Cable-Driver Gain Control

The AD9878 has a 3-pin interface to the AD832x family of programmable gain cable-driver amplifiers. This allows direct control of the cable driver's gain through the AD9878. In its default mode, the complete 8-bit register value is transmitted over the 3-wire cable amplifier (CA) interface.

If Bit 3 of Register 0x0F is set high, Bits [7:4] of Register 0x13 and Register 0x17 determine the 8-bit word sent over the CA interface, according to the specifications in Table 6. Bits [3:0] of Register 0x13 and Register 0x17 determine the fine gain setting of the DAC output, according to specifications in Table 7.

Table 6. Cable-Driver Gain Control

Bits [7:4]	CA Interface Transmit Word
0000	0000 0000 (default)
0001	0000 0001
0010	0000 0010
0011	0000 0100
0100	0000 1000
0101	0001 0000
0110	0010 0000
0111	0100 0000
1000	1000 0000

Table 7. DAC Output Fine Gain Setting

Bits [3:0]	DAC Fine Gain (dB)
0000	0.0 (default)
0001	0.5
0010	1.0
0011	1.5
...	...
1110	7.0
1111	7.5

New data is automatically sent over the 3-wire CA interface (and DAC gain adjust) whenever the value of the active gain control register changes or a new profile is selected. The default value is 0x00 (lowest gain).

The formula for the combined output-level calculation of AD9878 fine gain and AD8327 or AD8322 coarse gain is:

$$V_{8327} = V_{9878(0)} + (fine)/2 + (coarse) - 19$$

$$V_{8322} = V_{9878(0)} + (fine)/2 + (coarse) - 14$$

where:

fine is the decimal value of Bits [3:0].

coarse is the decimal value of Bits [7:4].

$V_{9878(0)}$ is the level at AD9878 output in dBmV for *fine* = 0.

V_{8327} is the level at output of AD8327 in dBmV.

V_{8322} is the level at output of AD8322 in dBmV.

SERIAL INTERFACE FOR REGISTER CONTROL

The AD9878 serial port is a flexible, synchronous, serial communications port that allows easy interface to many industry-standard microcontrollers and microprocessors. The interface allows read/write access to all registers that configure the AD9878. Single or multiple byte transfers are supported. Also, the interface can be programmed to read words either MSB first or LSB first. The AD9878 serial interface port I/O can be configured to have one bidirectional I/O (SDIO) pin, or two unidirectional I/O (SDIO/SDO) pins.

GENERAL OPERATION OF THE SERIAL INTERFACE

There are two phases of a communication cycle with the AD9878. Phase 1 is the instruction cycle, which is the writing of an instruction byte into the AD9878, coincident with the first eight SCLK rising edges. The instruction byte provides the AD9878 serial port controller with information regarding the data transfer cycle, which is Phase 2 of the communication cycle.

The Phase 1 instruction byte defines whether the upcoming data transfer is a read or write, the number of bytes in the data transfer, and the starting register address for the first byte of the data transfer. The first eight SCLK rising edges of each communication cycle are used to write the instruction byte into the AD9878.

The eight remaining SCLK edges are for Phase 2 of the communication cycle. Phase 2 is the actual data transfer between the AD9878 and the system controller. Phase 2 of the communication cycle is a transfer of one to four data bytes, as determined by the instruction byte. Normally, using one multibyte transfer is the preferred method. However, single-byte data transfers are useful to reduce CPU overhead when register access requires only one byte. Registers change immediately upon writing to the last bit of each transfer byte.

INSTRUCTION BYTE

The R/W bit of the instruction byte determines whether a read or a write data transfer occurs after the instruction byte write. Logic high indicates a read operation; logic low indicates a write operation. The [N1:N0] bits determine the number of bytes to be transferred during the data transfer cycle. The bit decodes are shown in Table 9. The timing diagrams are shown in Figure 19 and Figure 20.

Table 8. Instruction Byte Information

MSB 17	16	15	14	13	12	11	LSB 10
R/W	N1	N0	A4	A3	A2	A1	A0

Table 9. Bit Decodes

N1	N0	Description
0	0	Transfer 1 byte
0	1	Transfer 2 bytes
1	0	Transfer 3 bytes
1	1	Transfer 4 bytes

Bits [A4:A0] determine which register is accessed during the data transfer portion of the communication cycle. For multi-byte transfers, this address is the starting byte address. The remaining register addresses are generated by the AD9878.

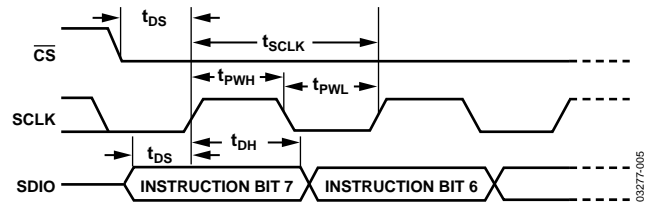

Figure 19. Timing Diagram for Register Write

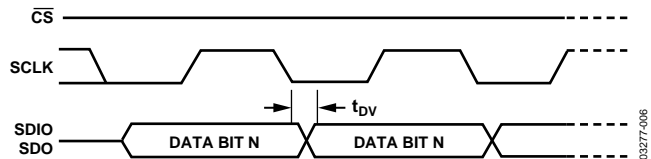

Figure 20. Timing Diagram for Register Read

SERIAL INTERFACE PORT PIN DESCRIPTIONS

SCLK—Serial Clock. The serial clock pin is used to synchronize data transfers from the AD9878 and to run the serial port state machine. The maximum SCLK frequency is 15 MHz. Input data to the AD9878 is sampled up on the rising edge of SCLK. Output data changes upon the falling edge of SCLK.

CS—Chip Select. Active low input starts and gates a communication cycle. It allows multiple devices to share a common serial port bus. The SDO and SDIO pins go into a high impedance state when CS is high. Chip select should stay low during the entire communication cycle.

SDIO—Serial Data I/O. Data is always written into the AD9878 on this pin. However, this pin can be used as a bidirectional data line. The configuration of this pin is controlled by Bit 7 of Register 0x00. The default is Logic 0, which configures the SDIO pin as unidirectional.

SDO—Serial Data Out. Data is read from this pin for protocols that use separate lines for transmitting and receiving data. In the case where the AD9878 operates in a single bidirectional I/O mode, this pin does not output data and is set to a high impedance state.

MSB/LSB TRANSFERS

The AD9878 serial port can support either MSB-first or LSB-first data formats. This functionality is controlled by the LSB-first bit in Register 0x00.

The AD9878 default serial port mode is MSB-first (see Figure 21), which is programmed by setting Register 0x00 low. In MSB-first mode, the instruction byte and data bytes must be written from the MSB to the LSB. In MSB-first mode, the serial port internal byte address generator decrements for each byte of the multibyte communication cycle. When decrementing from 0x00, the address generator changes to 0x1F.

When the LSB-first bit in Register 0x00 is set active high, the AD9878 serial port is in LSB-first format (Figure 22). In LSB-first mode, the instruction byte and data bytes must be written from the LSB to the MSB. In LSB-first mode, the serial port internal byte address generator increments for each byte of the multibyte communication cycle. When incrementing from 0x1F, the address generator changes to 0x00.

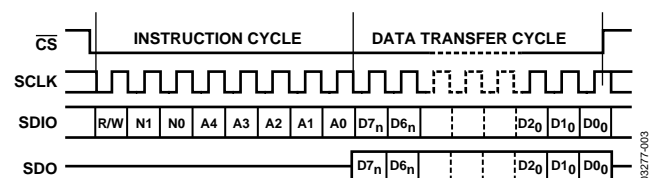

Figure 21. Serial Register Interface Timing, MSB-First Mode

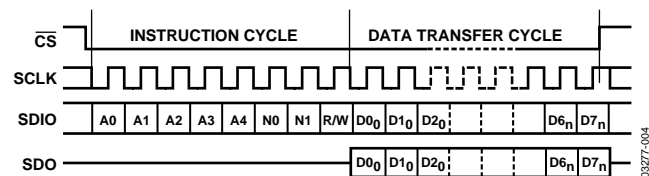

Figure 22. Serial Register Interface Timing, LSB-First Mode

NOTES ON SERIAL PORT OPERATION

The AD9878 serial port configuration bits reside in Bit 6 and Bit 7 of Register Address 0x00. Note that the configuration changes immediately upon writing to the last bit of the register. For multibyte transfers, writing to this register might occur during a communication cycle. Measures must be taken to compensate for this new configuration for the remaining bytes of the current communication cycle.

The same considerations apply when setting the reset bit in Register Address 0x00. All other registers are set to their default values, but the software reset does not affect the bits in Register Address 0x00. It is recommended to use only single-byte transfers when changing serial port configurations or initiating a software reset. A write to Bit 1, Bit 2, and Bit 3 of Address 0x00 with the same logic levels as Bit 7, Bit 6, and Bit 5 (bit pattern: XY1001YX binary) allows the user to reprogram a lost serial port configuration and to reset the registers to their default values. A second write to Address 0x00, with the reset bit low and the serial port configuration as specified above (XY), reprograms the OSCIN multiplier setting. A changed f_{SYSCLK} frequency is stable after a maximum of 200 f_{MCLK} cycles (wake-up time).

THEORY OF OPERATION

For a general understanding of the AD9878, refer to Figure 23, a block diagram of the device architecture. The device consists of a transmit path, receive path, and auxiliary functions, such as a PLL, a Σ - Δ DAC, a serial control port, and a cable amplifier interface.

The transmit path contains an interpolation filter, a complete quadrature digital upconverter, an inverse sinc filter, and a 12-bit current output DAC.

The receive path contains a 10-bit ADC and dual 12-bit ADCs. All internally required clocks and an output system clock are generated by the PLL from a single crystal or clock input.

The 12-bit and 10-bit IF ADCs can convert direct IF inputs of up to 70 MHz and run at sample rates of up to 29 MSPS. A video input with an adjustable signal clamping level, along with the 10-bit ADC, allow the AD9878 to process an NTSC and a QAM channel simultaneously.

The programmable Σ - Δ DAC can be used to control external components, such as variable gain amplifiers (VGAs) or voltage-controlled tuners. The CA port provides an interface to the AD832x family of programmable gain amplifier (PGA) cable drivers, enabling host processor control via the MxFE serial port (SPORT).

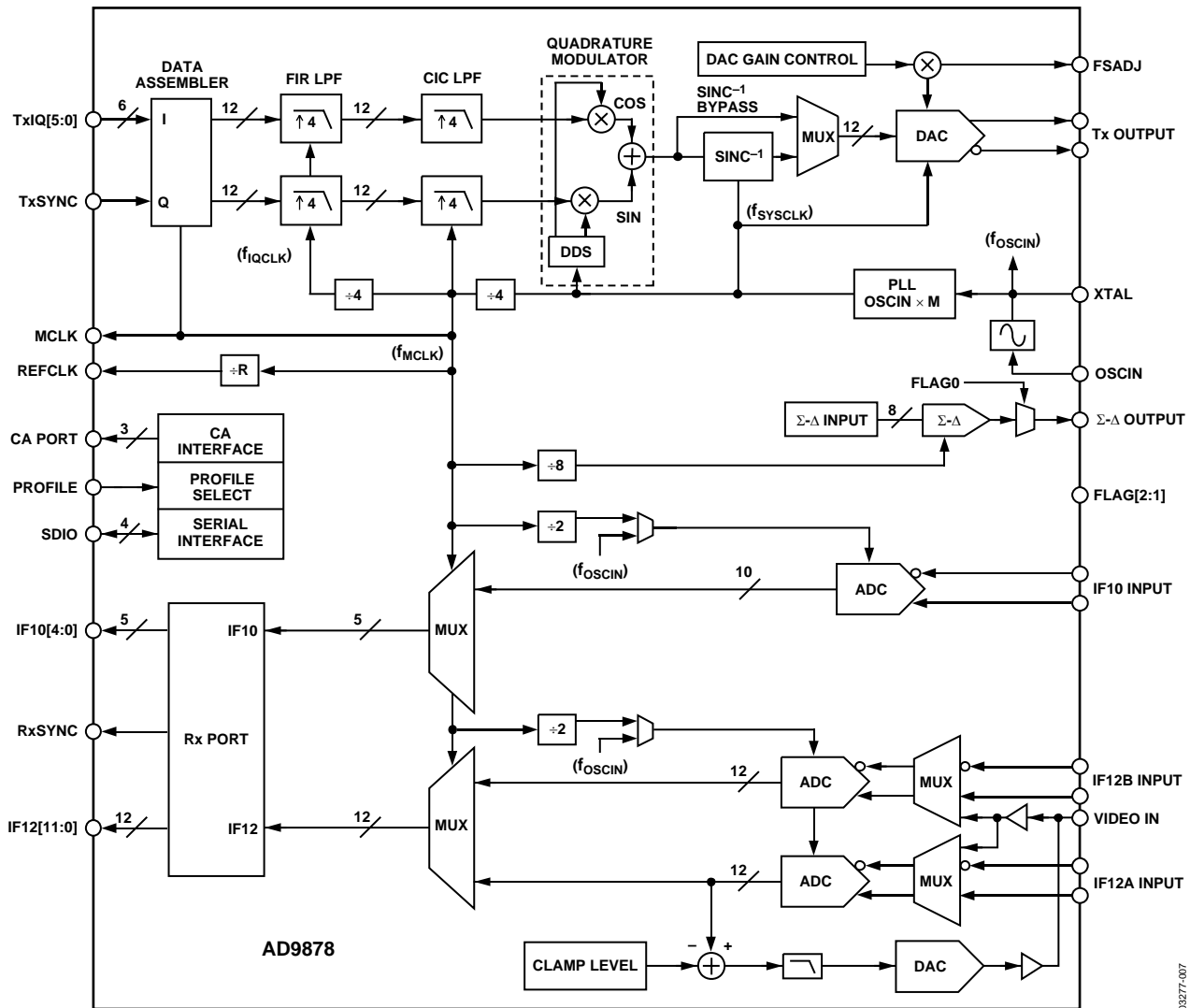

Figure 23. AD9878 Block Diagram

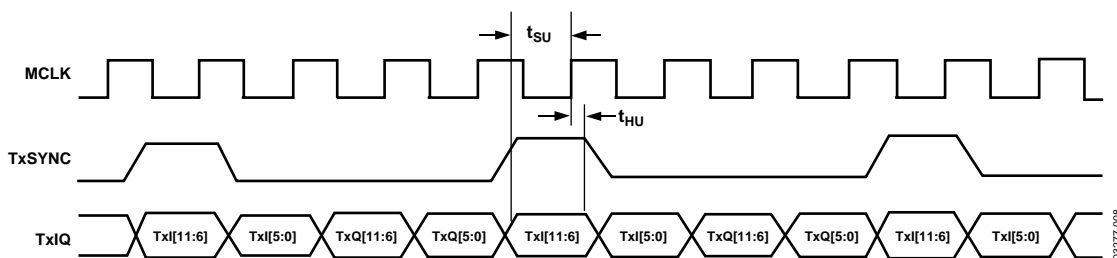

Figure 24. Tx Timing Diagram

TRANSMIT PATH

The transmit path contains an interpolation filter, a complete quadrature digital upconverter, an inverse sinc filter, and a 12-bit current output DAC. The maximum output current of the DAC is set by an external resistor. The Tx output PGA provides additional transmit signal level control. The transmit path interpolation filter provides an upsampling factor of 16 with an output signal bandwidth as high as 4.35 MHz for <1 dB droop. Carrier frequencies up to 65 MHz with 26 bits of frequency tuning resolution can be generated by the direct digital synthesizer (DDS). The transmit DAC resolution is 12 bits, and it can run at sampling rates of up to 232 MSPS. Analog output scaling from 0 dB to 7.5 dB in 0.5 dB steps is available to preserve SNR when reduced output levels are required.

DATA ASSEMBLER

The AD9878 data path operates on two 12-bit words, the I and Q components, that form a complex symbol. The data assembler builds the 24-bit complex symbol from four consecutive 6-bit words read over the TxIQ [5:0] bus. These words are strobed into the data assembler synchronous to the master clock (MCLK). A high level on TxSYNC signals the start of a transmit symbol. The first two 6-bit words of the symbol form the I component; the second two 6-bit words form the Q component. Symbol components are assumed to be in twos complement format. The timing of the interface is fully described in the Transmit Timing section. The I/Q sample rate f_{IQCLK} puts a bandwidth limit on the maximum transmit spectrum. This is the familiar Nyquist limit (hereafter referred to as f_{NYQ}) and is equal to half f_{IQCLK} .

TRANSMIT TIMING

The AD9878 has a master clock and expects 6-bit, multiplexed TxIQ data upon each rising edge (see Figure 24). Transmit symbols are framed with the TxSYNC input. TxSYNC high indicates the start of a transmit symbol. Four consecutive 6-bit data packages form a symbol (I MSB, I LSB, Q MSB, and Q LSB).

INTERPOLATION FILTER

Once through the data assembler, the IQ data streams are fed through a 4× FIR low-pass filter and a 4× cascaded integrator comb (CIC) low-pass filter. The combination of these two filters results in the sample rate increasing by a factor of 16. In addition

to the sample rate increase, the half-band filters provide the low-pass filtering characteristics necessary to suppress the spectral images between the original sampling frequency and the new (16× higher) sampling frequency.

HALF-BAND FILTERS (HBFs)

HBF 1 and HBF 2 are both interpolating filters, each of which doubles the sampling rate. Together, HBF 1 and HBF 2 have 26 taps and increase the sampling rate by a factor of 4 ($4 \times f_{IQCLK}$ or $8 \times f_{NYQ}$).

In relation to phase response, both HBFs are linear phase filters. As such, virtually no phase distortion is introduced within the pass band of the filters. This is an important feature, because phase distortion is generally intolerable in a data transmission system.

CASCADE INTEGRATOR COMB (CIC) FILTER

The CIC filter is configured as a programmable interpolator and provides a sample rate increase by a factor of 4. The frequency response of the CIC filter is given by:

$$|H(f)| = \left[\left(\frac{1}{4} \right) \frac{1 - e^{-j(2\pi f(4))}}{1 - e^{j2\pi f}} \right]^3 = \left[\left(\frac{1}{4} \right) \frac{\sin(4\pi f)}{\sin(\pi f)} \right]^3$$

COMBINED FILTER RESPONSE

The combined frequency response of the HBF and CIC filters limits the input signal bandwidth that can be propagated through the AD9878. The usable bandwidth of the filter chain limits the maximum data rate that can be propagated through the AD9878. A look at the pass-band detail of the combined filter response (Figure 25) indicates that to maintain an amplitude error of 1 dB or less, signal bandwidth is restricted to about 60% or less of f_{NYQ} .

$$\text{Max BW}_{(1\text{dB droop})} = 0.60 * f_{MCLK}/8$$

Thus, in order to keep the bandwidth of the data in the flat portion of the filter pass band, the user must oversample the baseband data by at least a factor of two prior to presenting it to the AD9878. Note that without oversampling, the Nyquist bandwidth of the baseband data corresponds to f_{NYQ} . As such, the upper end of the data bandwidth suffers 6 dB or more of attenuation due to the frequency response of the digital filters. Furthermore, if the baseband data applied to the AD9878 has

been pulse shaped, there is an additional concern. Typically, pulse shaping is applied to the baseband data via a filter with a raised cosine response. In such cases, an α value is used to modify the bandwidth of the data, where the value of α is such that

$$0 < \alpha < 1.$$

A value of 0 causes the data bandwidth to correspond to the Nyquist bandwidth. A value of 1 causes the data bandwidth to be extended to twice the Nyquist bandwidth. Thus, with $2\times$ oversampling of the baseband data and $\alpha = 1$, the Nyquist bandwidth of the data corresponds with the I/Q Nyquist bandwidth. As stated earlier, this results in problems near the upper edge of the data bandwidth due to the frequency response of the filters. The maximum value of α that can be implemented is 0.45, because the data bandwidth becomes

$$1/2(1 + \alpha) f_{NYQ} = 0.725 f_{NYQ}$$

which puts the data bandwidth at the extreme edge of the flat portion of the filter response.

If a particular application requires an α value between 0.45 and 1, the user must oversample the baseband data by at least a factor of 4. Over the frequency range of the data to be transmitted, the combined HBF 1, HBF 2, and CIC filters introduce a worst-case droop of less than 0.2 dB.

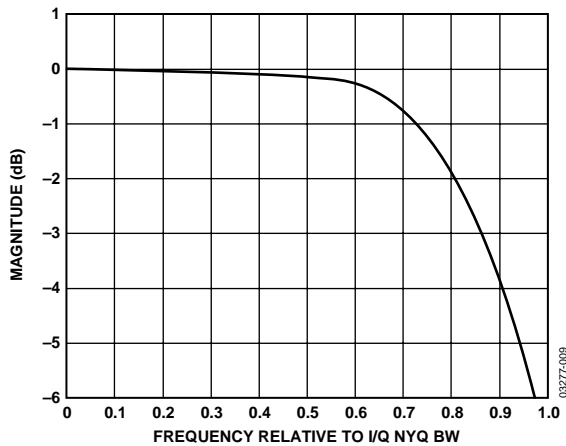

Figure 25. Cascaded Filter Pass Band

DIGITAL UPCONVERTER

The digital quadrature modulator stage following the CIC filters is used to frequency shift (upconvert) the baseband spectrum of the incoming data stream to the desired carrier frequency. The carrier frequency is controlled numerically by a direct digital synthesizer (DDS). The DDS uses the internal system clock (f_{SYSCLK}) to generate the desired carrier frequency with a high degree of precision. The carrier is applied to the I and Q multipliers in a quadrature fashion (90° phase offset) and summed to yield a data stream that is the modulated carrier. The modulated carrier becomes the 12-bit sample sent to the DAC.

Tx SIGNAL LEVEL CONSIDERATIONS

The quadrature modulator itself introduces a maximum gain of 3 dB in signal level. To visualize this, assume that both the I and Q data are fixed at the maximum possible digital value, x . Then, the output of the modulator, z , is

$$z = [x \cos(\omega t) - x \sin(\omega t)]$$

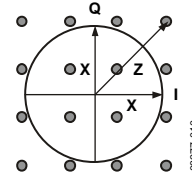

Figure 26. 16-Quadrature Modulation

It can be shown that $|z|$ assumes a maximum value of $|z| = \sqrt{x^2 + x^2} = x\sqrt{2}$ (a gain of +3 dB). However, if the same number of bits represent $|z|$ and x , an overflow occurs. To prevent this, an effective -3 dB attenuation is internally implemented on the I and Q data path:

$$|z| = \sqrt{1/2 + 1/2} = x$$

The following example assumes a peak rms level of 10 dB:

$$\begin{aligned} \text{Maximum Symbol Component Input Value} = \\ \pm 2047 \text{ LSBs} - 0.2 \text{ dB} = \pm 2000 \text{ LSBs} \end{aligned}$$

$$\begin{aligned} \text{Maximum Complex Input RMS Value} = \\ 2000 \text{ LSBs} \pm 6 \text{ dB} - \text{Peak rms (dB)} = 1265 \text{ LSBs rms} \end{aligned}$$

The maximum complex input rms value calculation uses both I and Q symbol components that add a factor of two (6 dB) to the formula. Table 10 shows typical I-Q input test signals with amplitude levels related to 12-bit full scale (FS).

Table 10. I-Q Input Test Signals

Analog Output	Digital Input	Input Level	Modulator Output Level
Single Tone ($f_c - f$)	$I = \cos(f)$ $Q = \cos(f + 90^\circ)$ $= -\sin(f)$	FS $- 0.2$ dB FS $- 0.2$ dB	FS $- 3.0$ dB
Single Tone ($f_c + f$)	$I = \cos(f)$ $Q = \cos(f + 270^\circ)$ $= +\sin(f)$	FS $- 0.2$ dB FS $- 0.2$ dB	FS $- 3.0$ dB
Dual Tone ($f_c \pm f$)	$I = \cos(f)$ FS $- 0.2$ dBFS $Q = \cos(f + 180^\circ)$ $= -\cos(f)$ or $Q = +\cos(f)$	FS $- 0.2$ dB FS $- 0.2$ dB	FS

Tx THROUGHPUT AND LATENCY

Data inputs affect the output fairly quickly, but remain effective due to the AD9878 filter characteristics. Data transmit latency through the AD9878 is easiest to describe in terms of f_{SYSCLK} clock cycles ($4 \times f_{\text{MCLK}}$). The numbers provided indicate the number of f_{SYSCLK} cycles before the AD9878 output responds to a change in the input.

Latency of I/Q data from the time it enters the data assembler (AD9878 input) to the time of DAC output is 119 f_{SYSCLK} clock cycles (29.75 f_{MCLK} cycles). DC values applied to the data assembler input take up to 176 f_{SYSCLK} clock cycles (44 f_{MCLK} cycles) to propagate and settle at the DAC output.

Frequency hopping is accomplished via changing the PROFILE input pin. The time required to switch from one frequency to another is less than 232 f_{SYSCLK} cycles (58.5 f_{MCLK} cycles).

DAC

A 12-bit digital-to-analog converter (DAC) is used to convert the digitally processed waveform into an analog signal. The worst-case spurious signals due to the DAC are the harmonics of the fundamental signal and their aliases (see the Analog Devices DDS tutorial at www.analog.com/dds). The conversion process produces aliased components of the fundamental signal at $n \times f_{\text{SYSCLK}} \pm f_{\text{CARRIER}}$ ($n = 1, 2, 3$). These are typically filtered with an external RLC filter at the DAC output. It is important for this analog filter to have a sufficiently flat gain and linear phase response across the bandwidth of interest to avoid modulation impairments. A relatively inexpensive seventh-order, elliptical, low-pass filter is sufficient to suppress the aliased components for HFC network applications.

The AD9878 provides true and complement current outputs. The full-scale output current is set by the R_{SET} resistor at Pin 49 and the DAC gain register. Assuming maximum DAC gain, the value of R_{SET} for a full-scale I_{OUT} is determined using the equation:

$$R_{\text{SET}} = 32 V_{\text{DACRSET}} / I_{\text{OUT}} = 39.4 / I_{\text{OUT}}$$

For example, if a full-scale output current of 20 mA is desired, then $R_{\text{SET}} = (39.4/0.02)$, or approximately 2 k Ω .

The following equation calculates the full-scale output current, including the programmable DAC gain control:

$$I_{\text{OUT}} = 39.4 / R_{\text{SET}} \times 10^{(-7.5 + 0.5N_{\text{GAIN}}) / 20}$$

where N_{GAIN} is the value of DAC fine gain control [3:0].

The full-scale output current range of the AD9878 is 4 to 20 mA. Full-scale output currents outside this range degrade SFDR performance. SFDR is also slightly affected by output matching—that is, the two outputs should be terminated equally for best SFDR performance. The output load should be located as close as possible to the AD9878 package to minimize stray

capacitance and inductance. The load can be a simple resistor to ground, an op amp current-to-voltage converter, or a transformer-coupled circuit. It is best not to directly drive a highly reactive load, such as an LC filter. Driving an LC filter without a transformer requires that the filter be doubly terminated for best performance—that is, both the filter input and output should be resistively terminated with the appropriate values. The parallel combination of the two terminations determines the load that the AD9878 sees for signals within the filter pass band. For example, a 50 Ω terminated input/output low-pass filter looks like a 25 Ω load to the AD9878. The output compliance voltage of the AD9878 is -0.5 V to $+1.5$ V. Any signal developed at the DAC output should not exceed 1.5 V; otherwise, signal distortion results. Furthermore, the signal can extend below ground as much as 0.5 V without damage or signal distortion. The AD9878 true and complement outputs can be differentially combined for common-mode rejection using a broadband 1:1 transformer.

Using a grounded center tap results in signals at the AD9878 DAC output pins that are symmetrical about ground. As previously mentioned, by differentially combining the two signals, the user can provide some degree of common-mode signal rejection.

A differential combiner can consist of a transformer or an op amp. The object is to combine or amplify the difference between only two signals and to reject any common—usually undesirable—characteristics, such as 60 Hz hum or clock feedthrough, that is equally present on both signals.

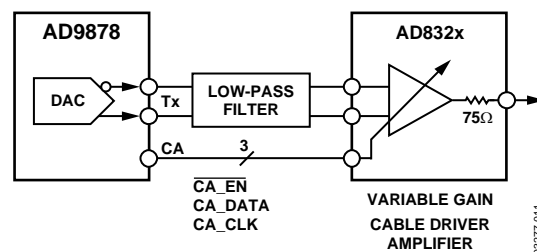

Figure 27. Cable Amplifier Connection

Connecting the AD9878 true and complement outputs to the differential inputs of the programmable gain cable drivers AD8321/AD8323 or AD8322/AD8327 (see Figure 27) provides an optimized solution for the standard compliant cable modem upstream channel. The cable driver's gain can be programmed through a direct 3-wire interface using the AD9878 profile registers.

PROGRAMMING THE AD8321/AD8323 OR AD8322/AD8327/AD8328 CABLE-DRIVER AMPLIFIERS

Users can program the gain of the AD832x family of cable-driver amplifiers via the AD9878 cable amplifier control interface. Two (one per profile) 8-bit registers within the AD9878 store the gain value to be written to the serial 3-wire port. Typically, either the AD8321/AD8323 or AD8322/AD8327 variable gain cable amplifiers are connected to the chip's 3-wire cable amplifier

interface. The Tx gain control select bit in Register 0x0F changes the interpretation of the bits in Register 0x13, Register 0x17, Register 0x1B, and Register 0x1F. See Figure 28 and the Cable-Driver Gain Control section.

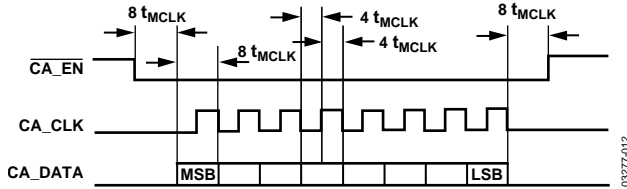

Figure 28. Cable Amplifier Interface Timing

Data transfers to the programmable gain cable-driver amplifier are initiated by the following conditions:

- **Power-Up and Hardware Reset:** Upon initial power-up and every hardware reset, the AD9878 clears the contents of the gain control registers to 0, which defines the lowest gain setting of the AD832x. Thus, the AD9878 writes all 0s out of the 3-wire cable amplifier control interface.
- **Software Reset:** Writing a 1 to Bit 5 of Address 0x00 initiates a software reset. Upon a software reset, the AD9878 clears the contents of the gain control registers to 0 for the lowest gain and sets the profile select to 0. The AD9878 writes all 0s out of the 3-wire cable amplifier control interface if the gain is previously on a different setting (different from 0).
- **Change in Profile Selection:** The AD9878 samples the PROFILE input pin together with the two profile select bits and writes to the AD832x gain control registers when a change in profile and gain is determined. The data written to the cable-driver amplifier comes from the AD9878 gain control register associated with the current profile.
- **Write to the AD9878 Cable-Driver Amplifier Control Registers:** The AD9878 writes gain control data associated with the current profile to the AD832x when the selected AD9878 cable-driver amplifier gain setting is changed. Once a new, stable gain value is detected (48 to 64 MCLK cycles after initiation) a data write starts with $\overline{CA_EN}$ going low. The AD9878 always finishes a write sequence to the cable-driver amplifier once it is started. The logic controlling data transfers to the cable-driver amplifier uses up to 200 MCLK cycles and is designed to prevent erroneous write cycles from occurring.

OSCIN CLOCK MULTIPLIER

The AD9878 can accept either an input clock into the OSCIN pin or a fundamental-mode crystal across the OSCIN and XTAL pins as the device's main clock source. The internal PLL then generates the f_{SYSCLK} signal from which all other internal signals are derived. The DAC uses f_{SYSCLK} as its sampling clock. For DDS applications, the carrier is typically limited to about

30% of f_{SYSCLK} . For a 65 MHz carrier, the system clock required is above 216 MHz. The OSCIN multiplier function maintains clock integrity, as evidenced by the part's excellent phase noise characteristics and low clock-related spur in the output spectrum.

External loop filter components, consisting of a series resistor (1.3 k Ω) and capacitor (0.01 μF), provide the compensation zero for the OSCIN multiplier PLL loop. The overall loop performance is optimized for these component values.

CLOCK AND OSCILLATOR CIRCUITRY

The AD9878's internal oscillator generates all sampling clocks from a simple, low cost, parallel resonance, fundamental frequency quartz crystal. Figure 29 shows how the quartz crystal is connected between OSCIN (Pin 61) and XTAL (Pin 60) with parallel resonant load capacitors, as specified by the crystal manufacturer. The internal oscillator circuitry can also be overdriven by a TTL-level clock applied to OSCIN with XTAL left unconnected.

$$f_{\text{OSCIN}} = f_{\text{MCLK}} \times M$$

An internal PLL generates the DAC sampling frequency, f_{SYSCLK} , by multiplying the OSCIN frequency by M. The MCLK signal (Pin 23), f_{MCLK} , is derived by dividing f_{SYSCLK} by 4.

$$f_{\text{SYSCLK}} = f_{\text{OSCIN}} \times M$$

$$f_{\text{MCLK}} = f_{\text{OSCIN}} \times M/4$$

An external PLL loop filter (Pin 57), consisting of a series resistor and ceramic capacitor (Figure 29: R1 = 1.3 k Ω , C12 = 0.01 μF), is required for stability of the PLL. Also, a shield surrounding these components is recommended to minimize external noise coupling into the PLL's voltage-controlled oscillator input (guard trace connected to AVDDPLL).

Figure 23 shows that ADCs are either sampled directly by a low jitter clock at OSCIN or by a clock that is derived from the PLL output. Operating modes can be selected in Register 0x08. Sampling the ADCs directly with the OSCIN clock requires that MCLK is programmed to be twice the OSCIN frequency.

PROGRAMMABLE CLOCK OUTPUT REFCLK

The AD9878 provides an auxiliary output clock on Pin 69, REFCLK. The value of the MCLK divider bit field, R, determines its output frequency, as shown in the following equations:

$$f_{\text{REFCLK}} = f_{\text{MCLK}} / R, \text{ for } R = 2 \text{ to } 63$$

$$f_{\text{REFCLK}} = f_{\text{OSCIN}}, \text{ for } R = 0$$

In its default setting (0x00 in Register 0x01), the REFCLK pin provides a buffered output of f_{OSCIN} .

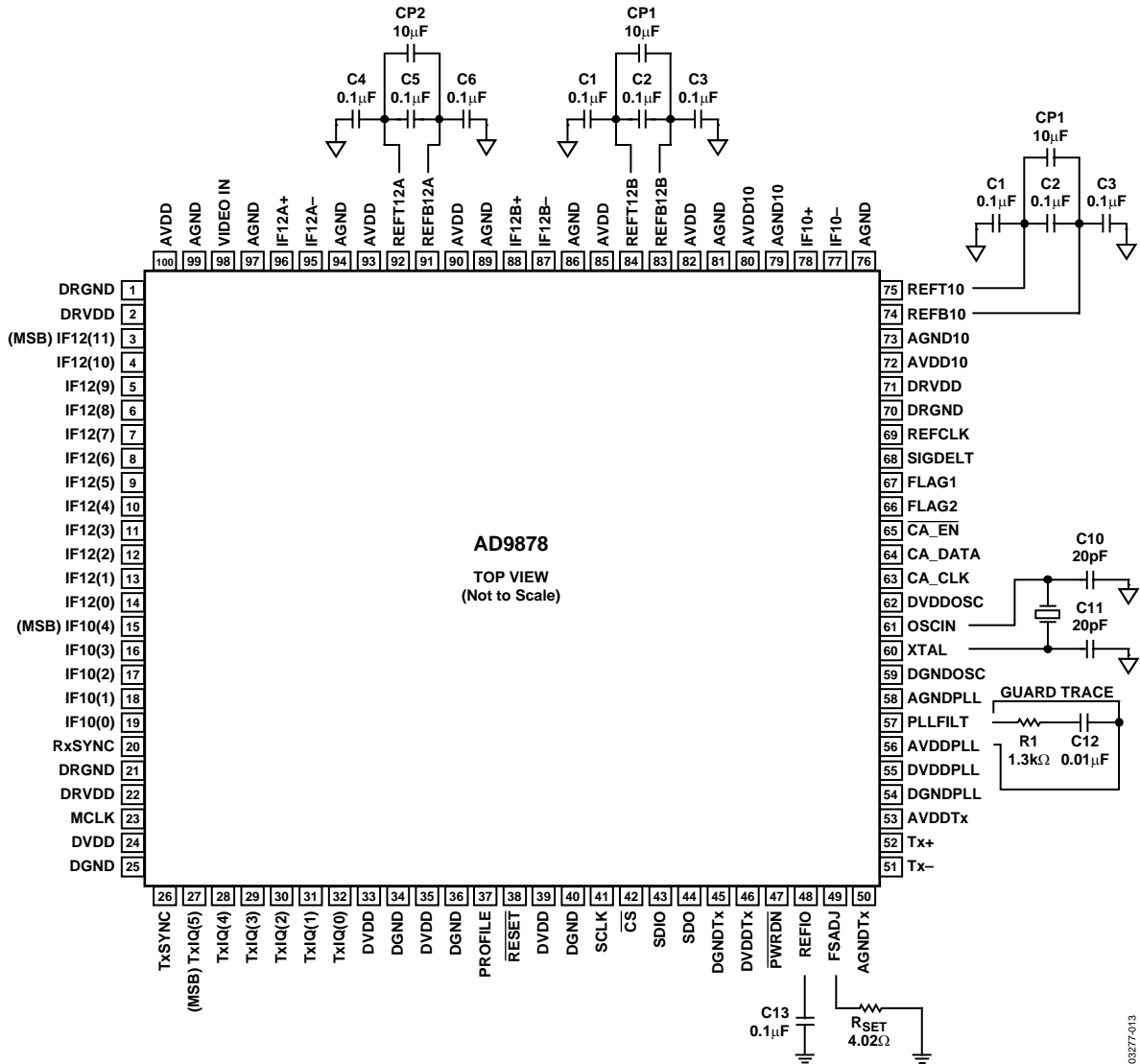

Figure 29. Basic Connection Diagram

03277-013

POWER-UP SEQUENCE

Upon initial power-up, the $\overline{\text{RESET}}$ pin should be held low until the power supply is stable (see Figure 30). Once $\overline{\text{RESET}}$ is deasserted, the AD9878 can be programmed over the serial port. The on-chip PLL requires a maximum of 1 ms after the rising edge of $\overline{\text{RESET}}$ or a change of the multiplier factor (M) to completely settle. It is recommended that the $\overline{\text{PWRDN}}$ pin is held low during the reset and PLL settling time. Changes to ADC clock select (Register 0x08) or System Clock Divider N (Register 0x01) should be programmed before the rising edge of $\overline{\text{PWRDN}}$. Once the PLL is frequency locked and after the $\overline{\text{PWRDN}}$ pin is brought high, transmit data can be sent reliably. If the $\overline{\text{PWRDN}}$ pin cannot be held low throughout the reset and PLL settling time period, the power-down digital Tx bit, or the $\overline{\text{PWRDN}}$ pin, should be pulsed after the PLL has settled. This ensures correct transmit filter initialization.

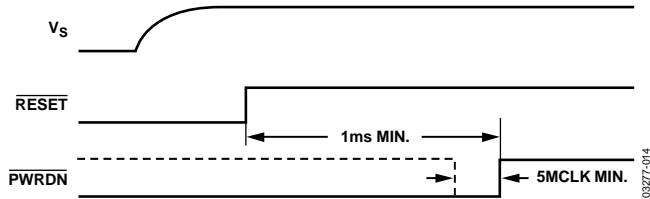

Figure 30. Power-Up Sequence for Tx Data Path

RESET

To initiate a hardware reset, the $\overline{\text{RESET}}$ pin should be held low for at least 100 ns. All internally generated clocks, except REFCLK, stop during reset. The rising edge of $\overline{\text{RESET}}$ resets the PLL clock multiplier and reinitializes the programmable registers to their default values. The same sequence as described in the Power-Up Sequence section should be followed after a reset or change in M.

A software reset (writing 1 into Bit 5 of Register 0x00) is functionally equivalent to a hardware reset, but does not force Register 0x00 to its default value.

TRANSMIT POWER-DOWN

A low level on the $\overline{\text{PWRDN}}$ pin stops all clocks linked to the digital transmit data path and resets the CIC filter. Deasserting $\overline{\text{PWRDN}}$ reactivates all clocks. The CIC filter is held in a reset state for 80 MCLK cycles after the rising edge of $\overline{\text{PWRDN}}$ to allow for flushing of the half-band filters with new input data. Transmit data bursts should be padded with at least 20 symbols of null data directly before the $\overline{\text{PWRDN}}$ pin is deasserted. Immediately after the $\overline{\text{PWRDN}}$ pin is deasserted, the transmit burst should start with a minimum of 20 null data symbols (see Figure 31). This avoids unintended DAC output samples caused by the transmit path latency and filter settling time.

Software power-down digital Tx (Bit 5 in Register 0x02) is functionally equivalent to the hardware $\overline{\text{PWRDN}}$ pin and takes effect immediately after the last register bit is written over the serial port.

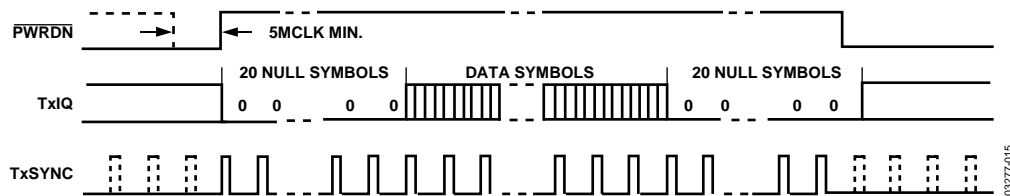

Figure 31. Timing Sequence to Flush Tx Data Path

Σ-Δ OUTPUTS

An on-chip Σ-Δ output provides a digital logic bit stream with an average duty cycle that varies between 0% and (255/256)%, depending on the programmed code, as shown in Figure 32.

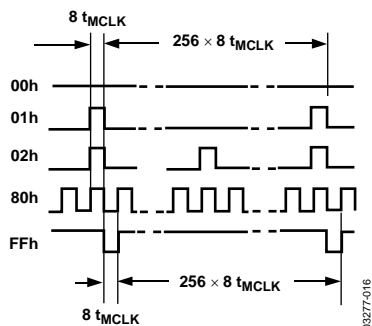

Figure 32. Σ-Δ Output Signals

This bit stream can be low-pass filtered to generate a programmable dc voltage of

$$V_{DC} = \left[\left(\frac{\Sigma-\Delta \text{ Code}}{256} \right) \times V_H \right] + V_L$$

where:

$$V_H = V_{DRVDD} - 0.6 \text{ V}$$

$$V_L = 0.4 \text{ V}$$

In cable set-top box applications, the output can be used to control external variable gain amplifiers or RF tuners. A single-pole, RC, low-pass filter provides sufficient filtering (see Figure 33). In more demanding applications, where additional gain, level-shift, or drive capability is required, consider using a first- or second-order filter (see Figure 34).

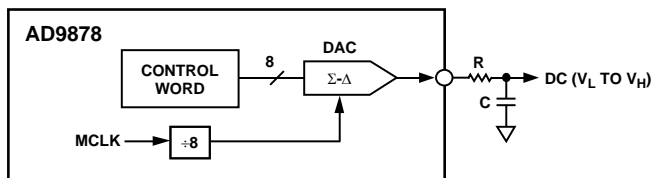

TYPICAL: R = 50kΩ
C = 0.01μF
f_{-3dB} = 1/(2πRC) = 318Hz

Figure 33. Σ-Δ RC Filter

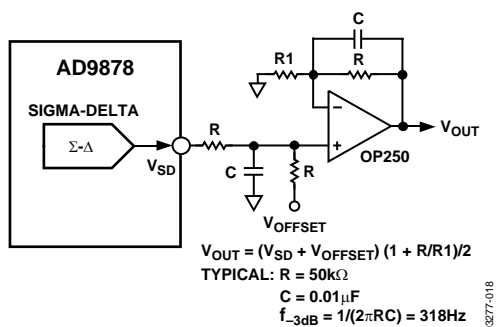

$V_{OUT} = (V_{SD} + V_{OFFSET}) (1 + R/R1)/2$
TYPICAL: R = 50kΩ
C = 0.01μF
f_{-3dB} = 1/(2πRC) = 318Hz

Figure 34. Σ-Δ Active Filter with Gain and Offset

RECEIVE PATH (Rx)

The AD9878 includes three high speed, high performance ADCs. The 10-bit and dual 12-bit direct-IF ADCs deliver excellent under-sampling performance with input frequencies as high as 70 MHz. The sampling rate can be as high as 29 MSPS. The ADC sampling frequency can be derived directly from the OSCIN signal, or from the on-chip OSCIN multiplier. For highest dynamic performance, choose an OSCIN frequency that can be directly used as the ADC sampling clock. Digital 12-bit ADC outputs are multiplexed to one 12-bit bus, clocked by a frequency (f_{MCLK}) four times the sampling rate. The IF ADCs use a multiplexer to a 12-bit interface with an output word rate of f_{MCLK}.

IF10 AND IF12 ADC OPERATION

The IF10 and IF12 ADCs have a common architecture and share several characteristics from an applications standpoint. Most of the information in the following section is applicable to both IF ADCs; differences, where they exist, are highlighted.

Input Signal Range and Digital Output Codes

The IF ADCs have differential analog inputs labeled IF+ and IF-. The signal input, V_{AIN}, is the voltage difference between the two input pins, V_{AIN} = V_{IF+} - V_{IF-}. The full-scale input voltage range is determined by the internal reference voltages, REFT and REFB, which define the top and bottom of the scale. The peak input voltage to the ADC is the difference between REFT and REFB, which is 1 V p-p. This results in an ADC full-scale input voltage of 2 V_{PPD}. The digital output codes are straight binary and are shown in Table 11.

Table 11. Digital Output Codes

IF12[11:0]	Input Signal Voltage
111...111	V _{AIN} ≥ +1.0 V
111...111	V _{AIN} = +1.0 V - 1 LSB
111...110	V _{AIN} = +1.0 V - 2 LSB
...	...
100...001	V _{AIN} = 0 V + 1 LSB
100...000	V _{AIN} = 0.0 V
011...111	V _{AIN} = 0 V - 1 LSB
...	...
000...001	V _{AIN} = -1.0 V + 2 LSB
000...000	V _{AIN} = -1.0 V
000...000	V _{AIN} < -1.0 V

Driving the Input

The IF ADCs have differential switched capacitor sample-and-hold amplifier (SHA) inputs. The nominal differential input impedance is $4.0\text{ k}\Omega \parallel 3\text{ pF}$. This impedance can be used as the effective termination impedance when calculating filter transfer characteristics and voltage signal attenuation from nonzero source impedances. For best performance, additional requirements must be met by the signal source. The SHA has input capacitors that must be recharged each time the input is sampled. This results in a dynamic input current at the device input, and demands that the source has low ($<50\ \Omega$) output impedance at frequencies up to the ADC sampling frequency. Also, the source must have settling of better than 0.1% in less than half the ADC clock period.

Another consideration for getting the best performance from the ADC inputs is the dc biasing of the input signal. Ideally, the signal should be biased to a dc level equal to the midpoint of the ADC reference voltages, REFT12 and REFB12. Nominally, this level is 1.2 V. When ac-coupled, the ADC inputs self-bias to this voltage and require no additional input circuitry. Figure 35 illustrates a recommended circuit that eases the burden on the signal source by isolating its output from the ADC input. The $33\ \Omega$ series termination resistors isolate the amplifier outputs from any capacitive load, which typically improves settling time. The series capacitors provide ac signal coupling, which ensures that the ADC inputs operate at the optimal dc-bias voltage. The shunt capacitor sources the dynamic currents required to charge the SHA input capacitors, removing this requirement from the ADC buffer. The values of C_C and C_S should be calculated to determine the correct HPF and LPF corner frequencies.

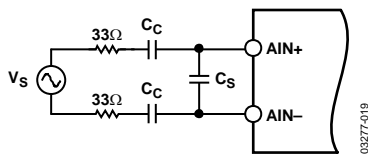

Figure 35. Simple ADC Drive Configuration

Receive Timing

The AD9878 sends multiplexed data to the IF10 and IF12 outputs upon every rising edge of MCLK. RxSYNC frames the start of each IF10 data symbol. The 10-bit and 12-bit ADCs are read completely upon every second MCLK cycle. RxSYNC is high for every second 10-bit ADC data if the 10-bit ADC is not in power-down mode. The Rx timing diagram is shown in Figure 36.

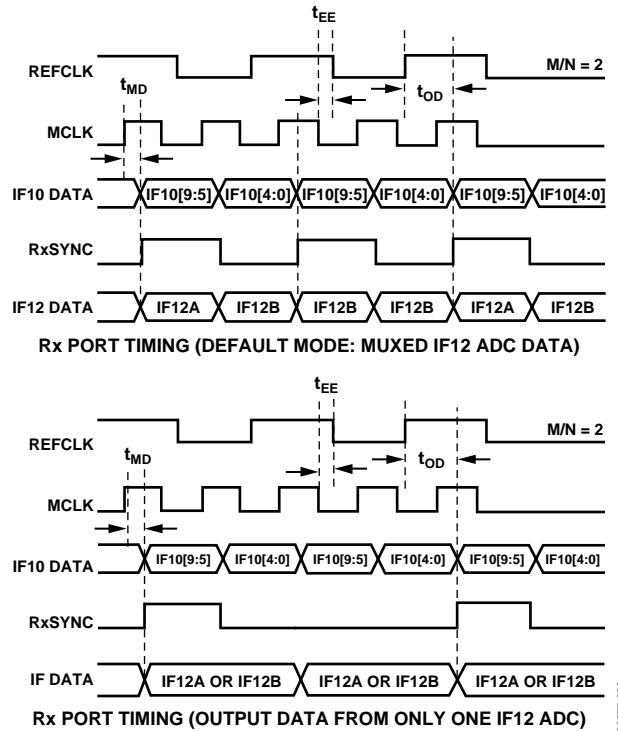

Figure 36. Rx Port Timing

ADC VOLTAGE REFERENCES

The AD9878 has three independent internal references for its 10-bit and 12-bit ADCs. Both 12-bit and 10-bit ADCs are designed for 2 V p-p input voltages and have their own internal reference. Figure 29 shows the proper connections of the REFT and REFB reference pins. External references might be necessary for systems that require high accuracy gain matching between ADCs, or for improvements in temperature drift and noise characteristics. External references REFT and REFB must be centered at $AVDD/2$, with offset voltages as specified by the following equations:

$$REFT_{-10, -12} : AVDD/2 + 0.5 V$$

$$REFB_{-10, -12} : AVDD/2 - 0.5 V$$

A differential level of 1 V between the reference pins results in a 2 V p-p ADC input level A_{IN} . Internal reference sources can be powered down when external references are used (Address 0x02).

VIDEO INPUT

For sampling video-type waveforms, such as NTSC and PAL signals, the video input channel provides black-level clamping. Figure 37 shows the circuit configuration for using the video channel input (Pin 98). An external blocking capacitor is used with the on-chip video clamp circuit to level-shift the input signal to a desired reference point. The clamp circuit automatically senses the most negative portion of the input signal and adjusts the voltage across the input capacitor. This forces the black level of the input signal to be equal to the value programmed in the clamp level register (Register Address 0x07).

By default, the video input is disabled and disconnected from both ADCs. By setting Register 0x07, Bit 7 = 1, the video input is enabled and connected to the ADC input as determined by the state of Reg 0x03, Bit 6 (0 = ADC12A connected, 1 = ADC12B connected.)

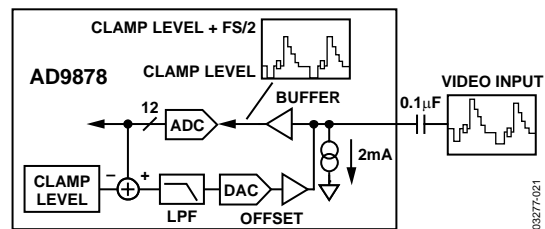

Figure 37. Video Clamp Circuit Input

PCB DESIGN CONSIDERATIONS

Although the AD9878 is a mixed-signal device, the part should be treated as an analog component. The on-chip digital circuitry is designed to minimize the impact of digital switching noise on the operation of the analog circuits. Following the recommendations in this section helps achieve the best performance from the MxFE.

COMPONENT PLACEMENT

The following guidelines for component placement are recommended to achieve optimal performance:

- Manage the path of return currents to ensure that high frequency switching currents from the digital circuits do not flow into the ground plane under the MxFE or analog circuits.
- Keep noisy digital signal paths and sensitive receive signal paths as short as possible.
- Keep digital (noise-generating) and analog (noise-susceptible) circuits as far apart as possible.

To best manage the return currents, pure digital circuits that generate high switching currents should be closest to the power supply entry. This keeps the highest frequency return current paths short and prevents them from traveling over the sensitive MxFE and analog portions of the ground plane. Also, these circuits should be generously bypassed at each device to further reduce high frequency ground currents. The MxFE should be placed adjacent to the digital circuits, such that the ground return currents from the digital sections do not flow into the ground plane under the MxFE. The analog circuits should be placed furthest from the power supply. The AD9878 has several pins that are used to decouple sensitive internal nodes: REFIO, REFB12A, REFT12A, REFB12B, REFT12B, REFB10, and REFT10. The decoupling capacitors connected to these points should have low ESR and ESL, be placed as close as possible to the MxFE, and be connected directly to the analog ground plane. The resistor connected to the FSADJ pin and the RC network connected to the PLLFILT pin should also be placed close to the device and connected directly to the analog ground plane.

POWER PLANES AND DECOUPLING

The AD9878 evaluation board (Figure 38 and Figure 39) demonstrates a good power supply distribution and decoupling strategy. The board has four layers: two signal layers, one ground plane, and one power plane. The power plane is split into a 3-V_{DD} section that is used for the 3 V digital logic circuits, a DVDD section that is used to supply the digital supply pins of the AD9878, an AVDD section that is used to supply the analog supply pins of the AD9878, and a VANLG section that supplies the higher voltage analog components on the board. The 3-V_{DD} section typically has the highest frequency currents on the power plane and should be kept the furthest from the MxFE and analog sections of the board.

The DVDD portion of the plane carries the current used to power the digital portion of the MxFE to the device. This should be treated similarly to the 3-V_{DD} power plane and be kept from going underneath the MxFE or analog components. The MxFE should largely sit above the AVDD portion of the power plane. The AVDD and DVDD power planes can be fed from the same low noise voltage source; however, they should be decoupled from each other to prevent the noise generated in the DVDD portion of the MxFE from corrupting the AVDD supply. This can be done by using ferrite beads between the voltage source and DVDD, and between the source and AVDD. Both DVDD and AVDD should have a low ESR, bulk-decoupling capacitor on the MxFE side of the ferrite as well as low ESR- and ESL-decoupling capacitors on each supply pin (for example, the AD9878 requires 17 power supply decoupling capacitors). The decoupling capacitors should be placed as close as possible to the MxFE supply pins. An example of proper decoupling is shown in the AD9878 evaluation board's two-page schematic (Figure 38 and Figure 39).

GROUND PLANES

In general, if the component placing guidelines discussed earlier can be implemented, it is best to have at least one continuous ground plane for the entire board. All ground connections should be as short as possible. This results in the lowest impedance return paths and the quietest ground connections. If the components cannot be placed in a manner that keeps the high frequency ground currents from traversing under the MxFE and analog components, it might be necessary to put current-steering channels into the ground plane to route the high frequency currents around these sensitive areas. These current-steering channels should be used only when and where necessary.

SIGNAL ROUTING

The digital Rx and Tx signal paths should be as short as possible. Also, these traces should have a controlled impedance of about 50 Ω. This prevents poor signal integrity and the high currents that can occur during undershoot or overshoot caused by ringing. If the signal traces cannot be kept shorter than about 1.5 inches, then series termination resistors (33 Ω to 47 Ω) should be placed close to all signal sources. It is a good idea to series terminate all clock signals at their source, regardless of trace length. The receive signals are the most sensitive signals on the evaluation board. Careful routing of these signals is essential for good receive path performance. The IF+/IF- signals form a differential pair and should be routed together. By keeping the traces adjacent to each other, noise coupled onto the signals appears as common mode and is largely rejected by the MxFE receive input. Keeping the driving point impedance of the receive signal low and placing any low-pass filtering of the signals close to the MxFE further reduces the possibility of noise corrupting these signals.

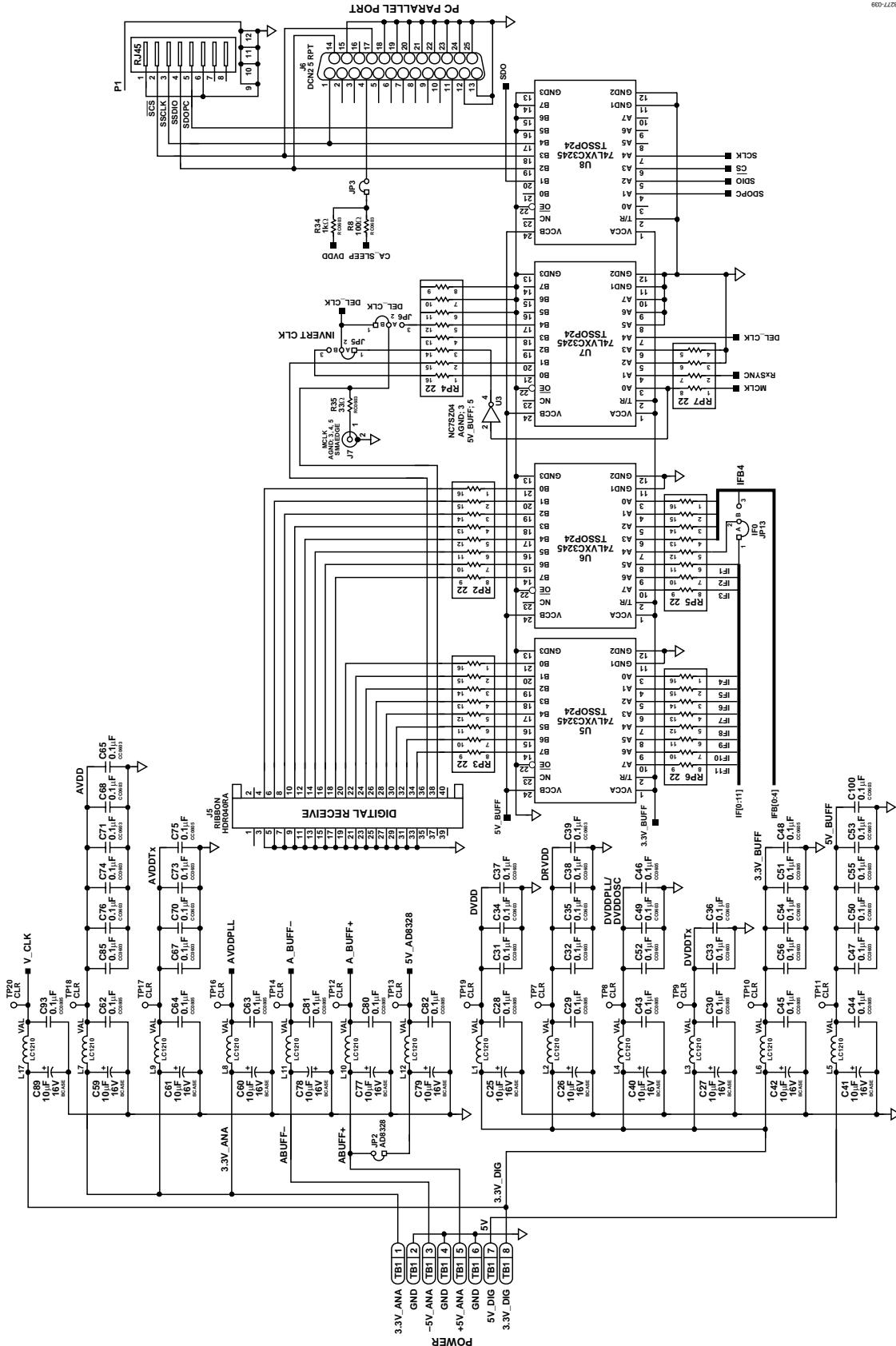

Figure 39. Evaluation PCB Schematic (Continued)

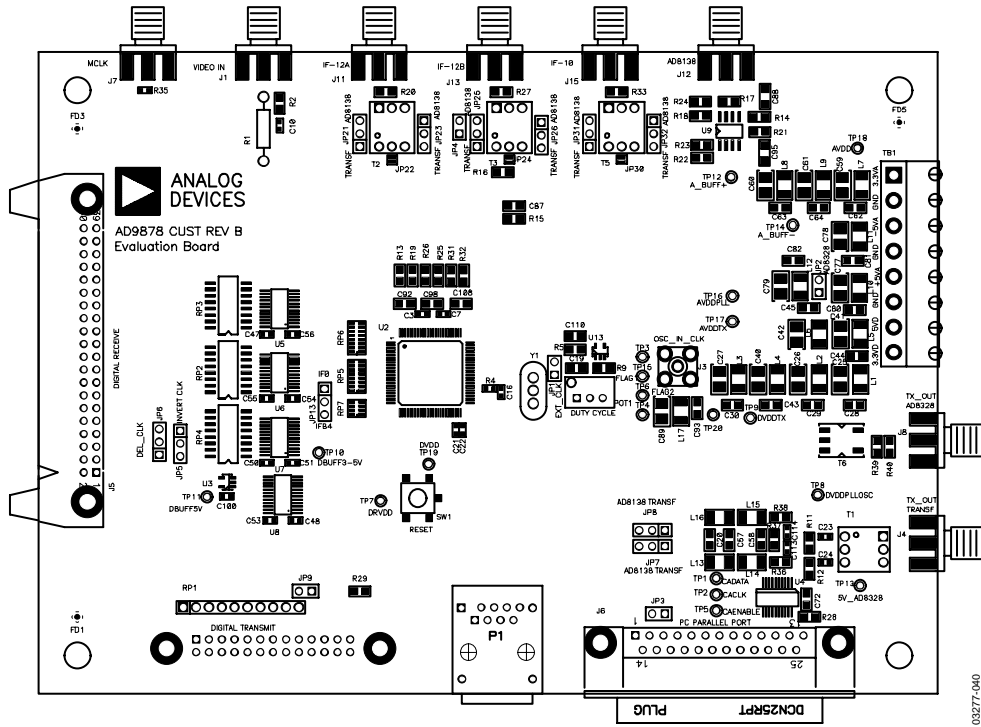

Figure 40. Evaluation PCB—Top Assembly

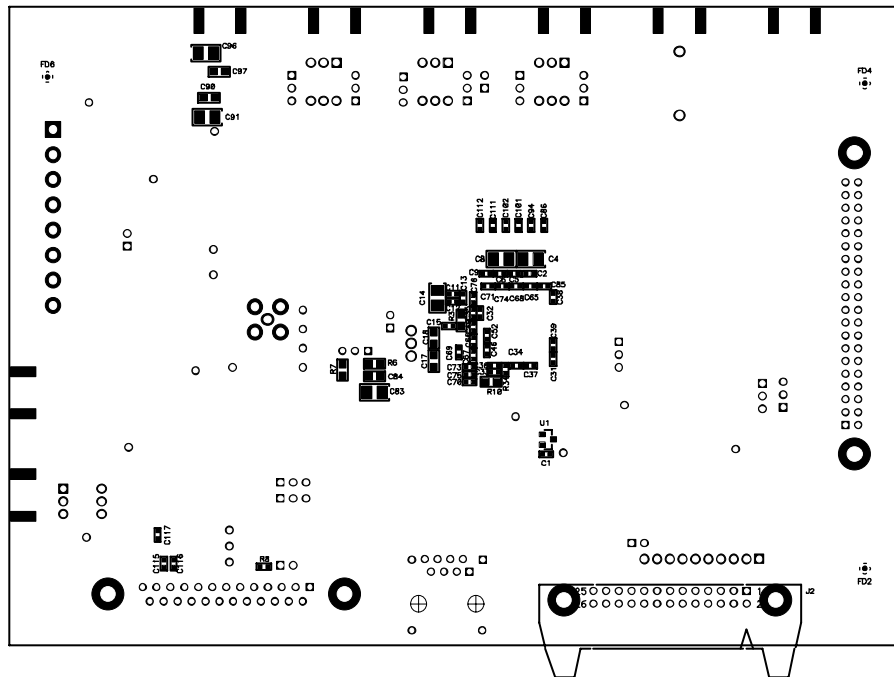
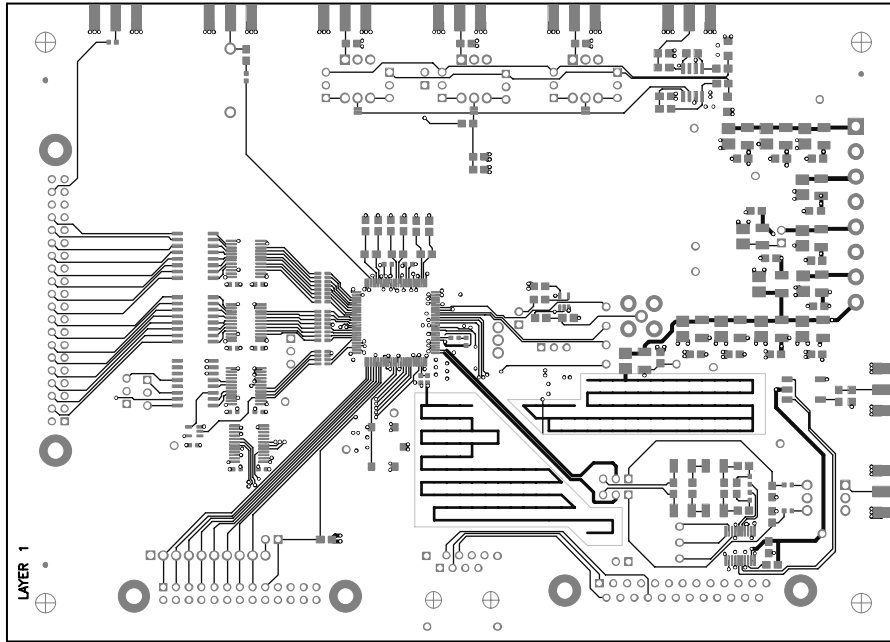
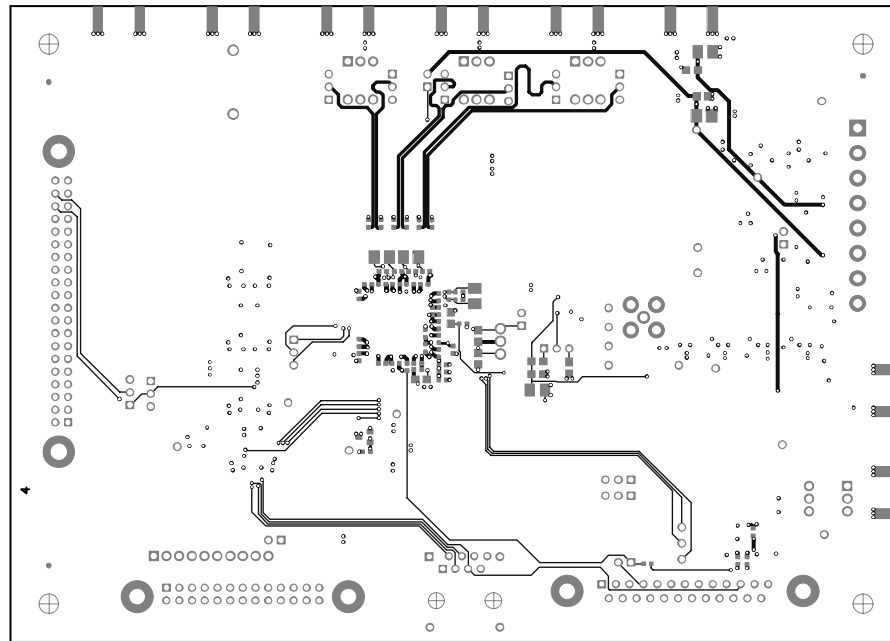

Figure 41. Evaluation PCB—Bottom Assembly



03277-042

Figure 42. Evaluation PCB Layout—Top Layer



03277-043

Figure 43. Evaluation PCB Layout—Bottom Layer

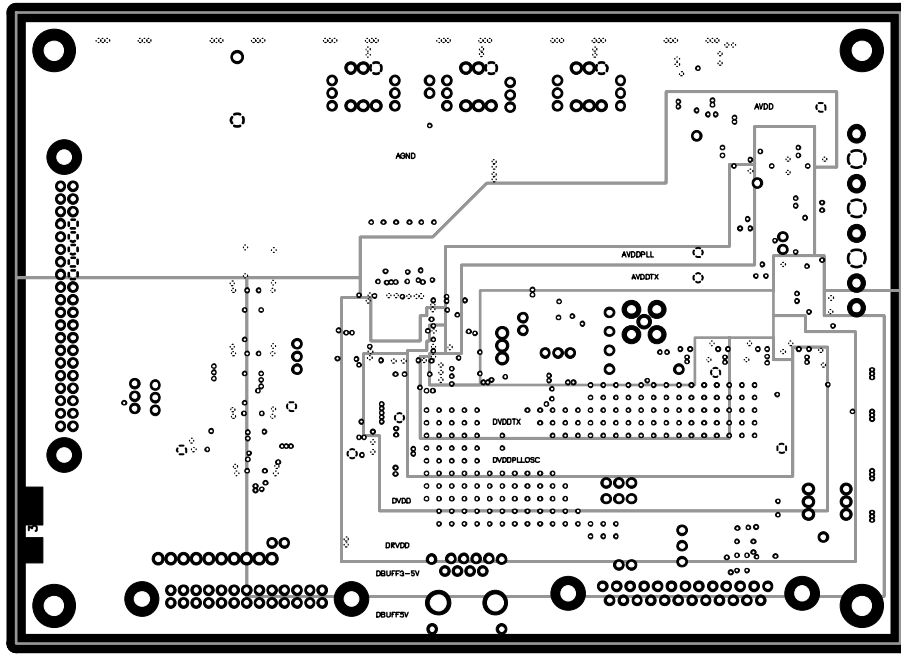

03277-044

Figure 44. Evaluation PCB—Power Plane

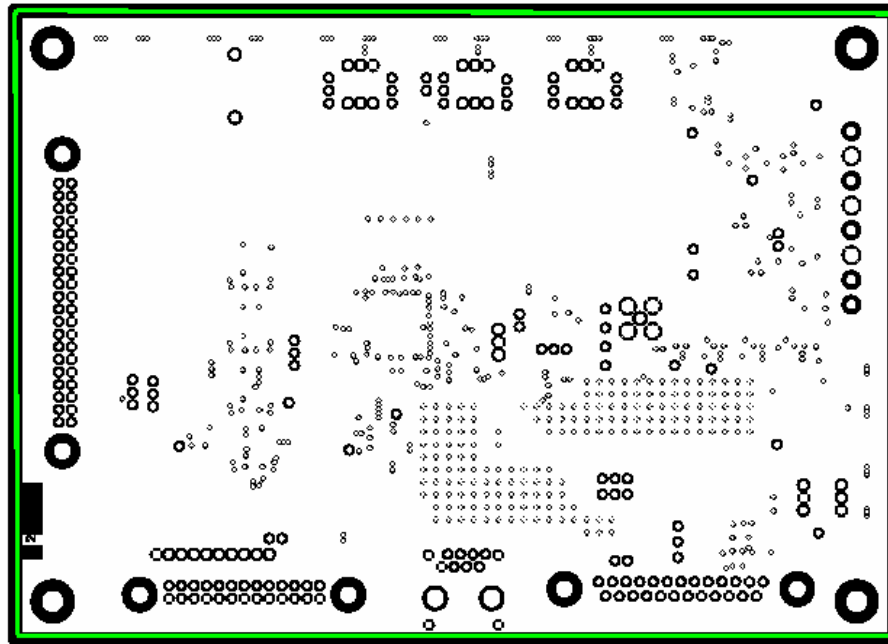

03277-045

Figure 45. Evaluation PCB—Ground Plane

OUTLINE DIMENSIONS

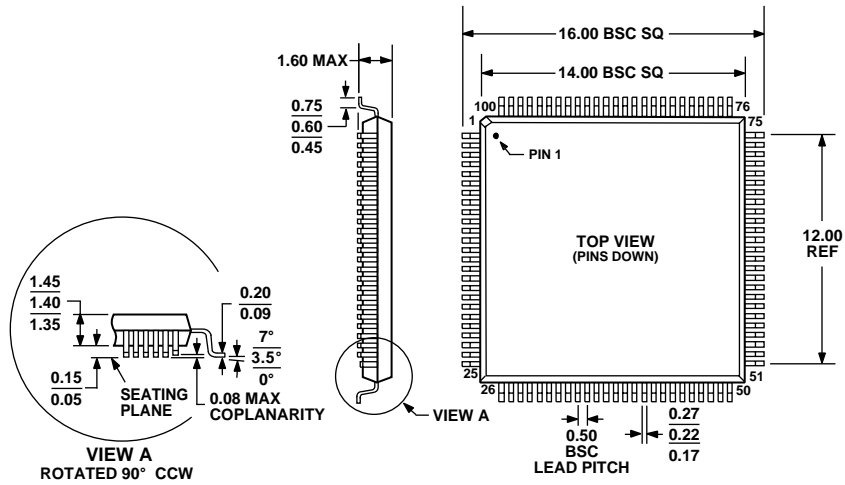

COMPLIANT TO JEDEC STANDARDS MS-026BED

Figure 46. 100-Lead Low Profile Quad Flat Package [LQFP] (ST-100)
Dimensions shown in millimeters

ORDERING GUIDE

Model	Temperature Range	Package Description	Package Option
AD9878BST	-40°C to +85°C	100-LQFP	ST-100
AD9878BSTZ ¹	-40°C to +85°C	100-LQFP	ST-100
AD9878-EB		Evaluation Board	

¹ Z = Pb-free part.

Looking for pricing, stock, or lifecycle information?

Click below to explore more details on WIN SOURCE:

 [View AD9878BSTZ on WIN SOURCE](#)

 [Analog Devices Inc. Information](#)

Optimize Your Supply Chain with WIN SOURCE Solutions

-  Global Sourcing Solution
-  Obsolete Management
-  Cost Control Management
-  Shortage Management
-  Alternative Solution
-  Excess Inventory Management