





# THE DATASHEET OF DSK110



**SPECIFICATION SHEET**

<b>SPECIFICATION SHEET NO.</b>	P1030-- SOD123FK1AS110
<b>DATE</b>	Oct. 30, 2022
<b>REVISION</b>	A1
<b>DESCRIPTION</b>	SMD Schottky Barrier Rectifier, 2 Pads, SOD-123FL series, DSK110 Type Reverse Voltage 100V Max. Forward Current 1.0A Max. Operating Temp. Range -55°C ~+150°C Package in Tape/Reel, 3000pcs/Reel RoHS/RoHS III compliant
<b>CUSTOMER</b>	
<b>CUSTOMER PART NUMBER</b>	
<b>CROSS REF. PART NUMBER</b>	
<b>ORIGINAL PART NUMBER</b>	MDD DSK110
<b>PART CODE</b>	SOD123FK1AS110

<b>VENDOR APPROVE</b>			
Issued/Checked/Approved			
DATE: Oct. 30, 2022			

<b>CUSTOMER APPROVE</b>	
DATE:	

11/2/2022

**SMD SCHOTTKY BARRIER RECTIFIER SOD-123FL SERIES**

**MAIN FEATURE**



- The plastic package carries Underwriters Laboratory Flammability Classification 94V-0
- Low reverse leakage
- Built-in strain relief
- Low power loss, high efficiency
- High forward surge current capability
- High temperature soldering guaranteed: 250°C/ 10 seconds at terminals
- Metal silicon junction, majority carrier conduction

**APPLICATION**

- For printed circuit board

**RFQ**

[Request For Quotation](#)

**PART CODE GUIDE**

SOD123F	K1A	S	110
1	2	3	4

- 1) **SOD123F**: SMD Schottky Barrier Rectifier, 2 Pads, SOD-123FL series,
- 2) **K1A**: Type code for original part number DSK110
- 3) **S**: Package code, Tape/reel, 3000pcs/reel.
- 4) **110**: Specification code for Reverse Voltage 100V Max. Forward Current 1.0A Max

**MORE ITEMS AVAILABLE**

SOD123FK12S102	SOD123FK13S103	SOD123FK14S104	SOD123FK16S106	SOD123FK18S108
<b>SOD123FK1AS110</b>	SOD123FK1BS115	SOD123FK1CS120		
SOD123FK22S202	SOD123FK23S203	SOD123FK24S204	SOD123FK26S206	SOD123FK28S208
SOD123FK2AS210	SOD123FK2BS215	SOD123FK2CS220		
SOD123FK32S302	SOD123FK33S303	SOD123FK34S304	SOD123FK36S306	SOD123FK38S308
SOD123FK3AS310	SOD123FK3BS315	SOD123FK3CS320		

**SMD SCHOTTKY BARRIER RECTIFIER SOD-123FL SERIES**

**DIMENSION (Unit: Inch/mm)**

Image for reference



Marking: K110

SOD-123FL

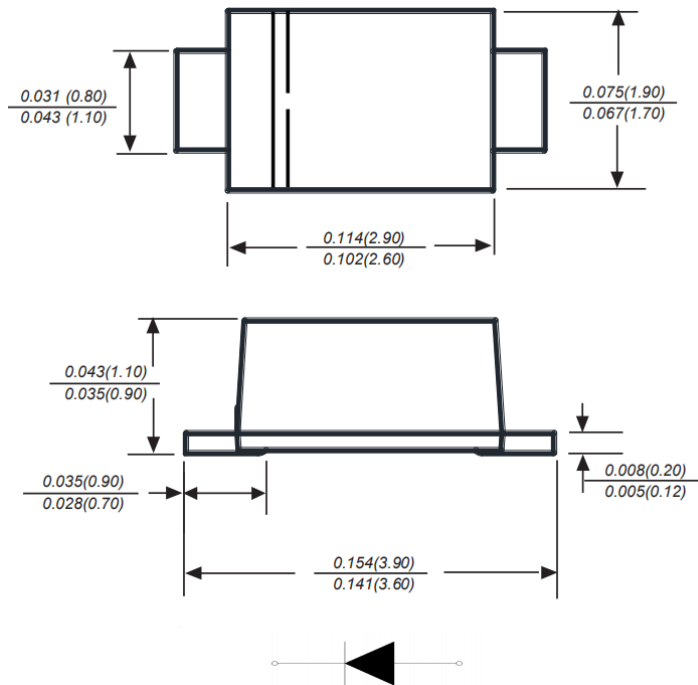

Recommend Pad Layout

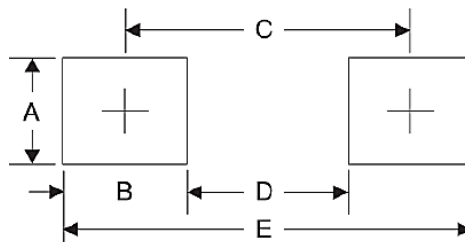

Symbol	Unit (Inch)	Unit (mm)
A	0.047	1.20
B	0.047	1.20
C	0.126	3.20
D	0.079	2.00
E	0.173	4.40

**SMD SCHOTTKY BARRIER RECTIFIER SOD-123FL SERIES**
**MECHANICAL DATA**

Case	Terminals	Polarity	Mounting Position	Weight per piece
JEDEC SOD-123FL molded plastic body	Solder plated, Solderable per MIL-STD-750, Method 2026	Color band denotes cathode end	Any	0.0007 Ounce, 0.0198 grams

**MAX. RATING & CHARACTERISTICS**

Parameter	SYMBOLS	VALUE			UNITS
		Min.	Typical	Max.	
Repetitive peak reverse voltage	V <sub>RRM</sub>			100	Volts
RMS voltage	V <sub>RMS</sub>			70	Volts
DC blocking voltage	V <sub>DC</sub>			100	Volts
Average forward output rectified current at TL (see fig.1)	I <sub>AV</sub>			1.0	A
Peak forward surge current 8.3ms single half sine-wave superimposed on rated load (JEDEC Method)	I <sub>FSM</sub>		25		A
Instantaneous forward voltage at 1.0A	V <sub>F</sub>			0.85	Volts
DC reverse current at rated DC blocking voltage	I <sub>R</sub>			0.2	mA
				5.0	mA
Junction capacitance (Note 2)	C <sub>J</sub>		80		pF
Thermal resistance (Note 3)	R <sub>QJA</sub>		100		°C/W
Operating junction temperature range	T <sub>J</sub>	-55		+150	°C
Storage temperature range	T <sub>STG</sub>	-55		+150	°C

**Note**

1. Ratings at 25 C ambient temperature unless otherwise specified. Single phase half-wave 60Hz, resistive or inductive load, for capacitive load current derate by 20%.
2. Measured at 1.0MHz and applied reverse voltage of 4.0Voltage
3. P.C.B. mounted with 0.2x0.2”(5.0x5.0mm) copper pad areas.

11/2/2022

**SMD SCHOTTKY BARRIER RECTIFIER SOD-123FL SERIES**

**RELIABILITY**

Number	Experiment Items	Experiment Method And Conditions	Reference Documents
1	Solder Resistance Test	Test 260°C± 5°C for 10 ± 2 sec. Immerse body into solder 1/16" ± 1/32"	MIL-STD-750D METHOD-2031.2
2	Solderability Test	230°C ±5°C for 5 sec.	MIL-STD-750D METHOD-2026.1 0
3	Pull Test	1 kg in axial lead direction for 10 sec.	MIL-STD-750D METHOD-2036.4
4	Bend Test	0.5Kg Weight Applied To Each Lead, Bending Arcs 90 °C ± 5 °C For 3 Times	MIL-STD-750D METHOD-2036.4
5	High Temperature Reverse Bias Test	TA=100°C for 1000 Hours at VR=80% Rated VR	MIL-STD-750D METHOD-1038.4
6	Forward Operation Life Test	TA=25°C Rated Average Rectified Current	MIL-STD-750D METHOD-1027.3
7	Intermittent Operation Life Test	On state: 5 min with rated IRMS Power Off state: 5 min with Cool Forced Air. On and off for 1000 cycles.	MIL-STD-750D METHOD-1036.3
8	Pressure Cooker Test	15 PSIG, TA=121°C, 4 hours	MIL-S-19500 APPENOIXC
9	Temperature Cycling Test	-55°C~+125°C; 30 Minutes For Dwelled Time 5 minutes for transferred time. Total: 10 cycles.	MIL-STD-750D METHOD-1051.7
10	Thermal Shock Test	0°C for 5 minutes., 100°C for 5minutes, Total: 10 cycles	MIL-STD-750D METHOD-1056.7
11	Forward Surge Test	8.3ms Single Sale Sine-wave One Surge.	MIL-STD-750D METHOD-4066.4
12	Humidity Test	TA=65°C, RH=98% for 1000 hours.	MIL-STD-750D METHOD-1021.3
13	High Temperature Storage life Test	150°C for 1000 Hours	MIL-STD-750D METHOD-1031.5

**SMD SCHOTTKY BARRIER RECTIFIER SOD-123FL SERIES**

**SUGGESTED REFLOW PROFILE (For Reference Only)**

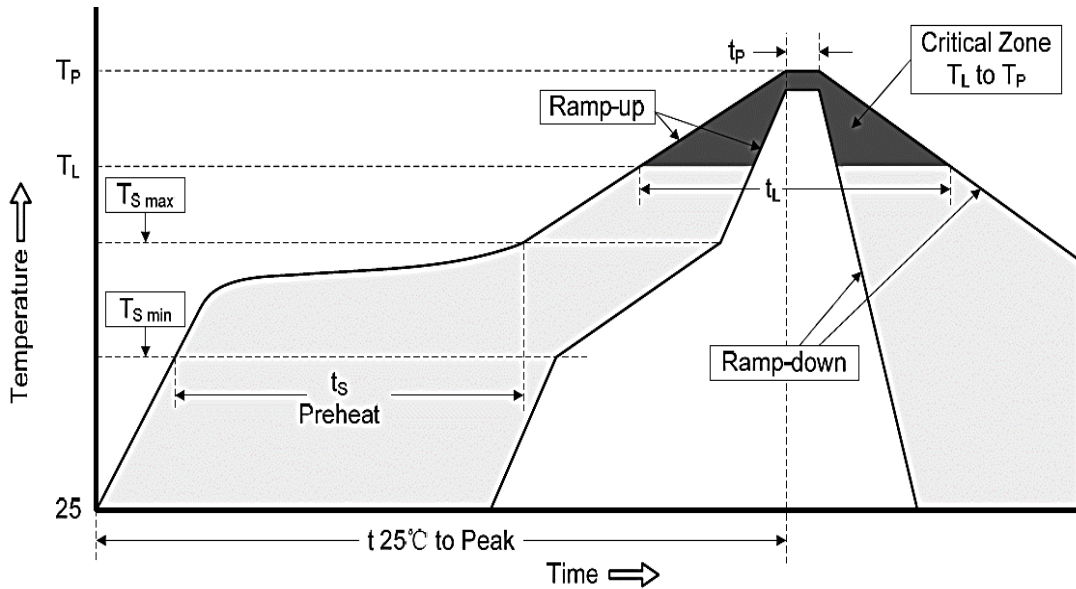

Profile Feature		Pb-Free Assembly
Average Ramp-up Rate (Ts Max to Tp)		3°C/second Max
Preheat	Temperature Min (Ts Min.)	150°C
	Temperature Max (Ts Max.)	200°C
	Time (ts Min. to ts Max.)	60 ~ 180 seconds
Time maintained above	Temperature (Tl)	217°C
	Time (tl)	60 ~ 150 seconds
Peak/Classification Temperature (Tp)		250 °C
Time within 5°C of actual Peak Temperature (tp)		10 seconds
Ramp-down rate		6 °C /Second Max.
Time 25 °C to Peak Temperature		6 minutes Max.
Suggest reflow times		3 Times Max.

**SMD SCHOTTKY BARRIER RECTIFIER SOD-123FL SERIES**

**RATINGS AND CHARACTERISTIC CURVES (For Reference Only)**

Fig.1 Forward Current Derating Curve

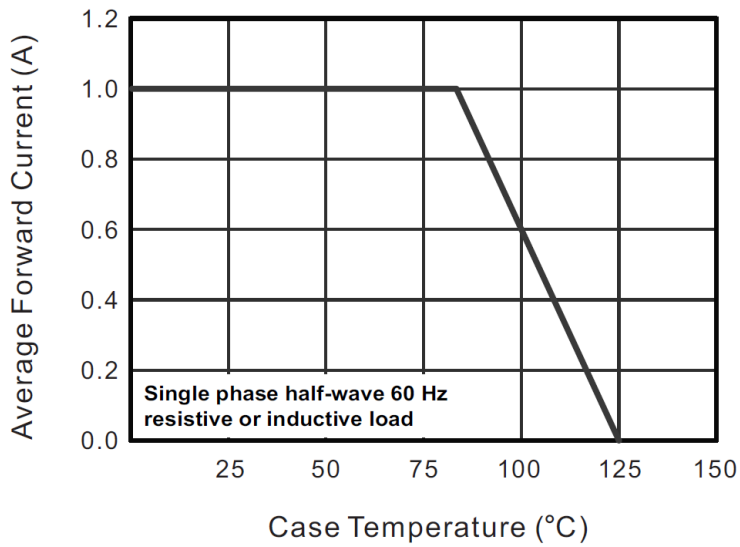
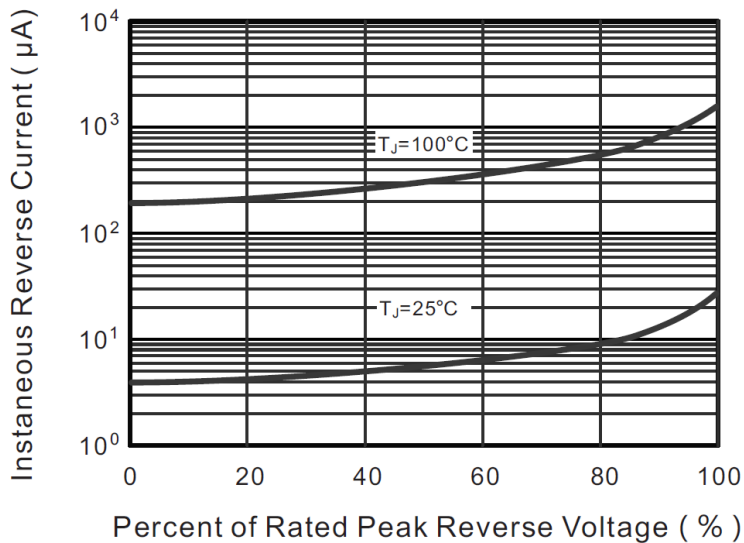

Fig.2 Typical Reverse Characteristics



**SMD SCHOTTKY BARRIER RECTIFIER SOD-123FL SERIES**

**RATINGS AND CHARACTERISTIC CURVES (For Reference Only)**

Fig.3 Typical Forward Characteristic

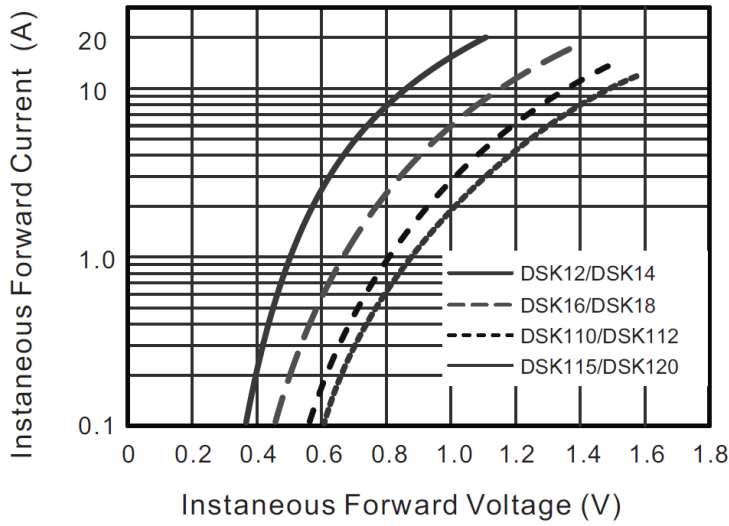
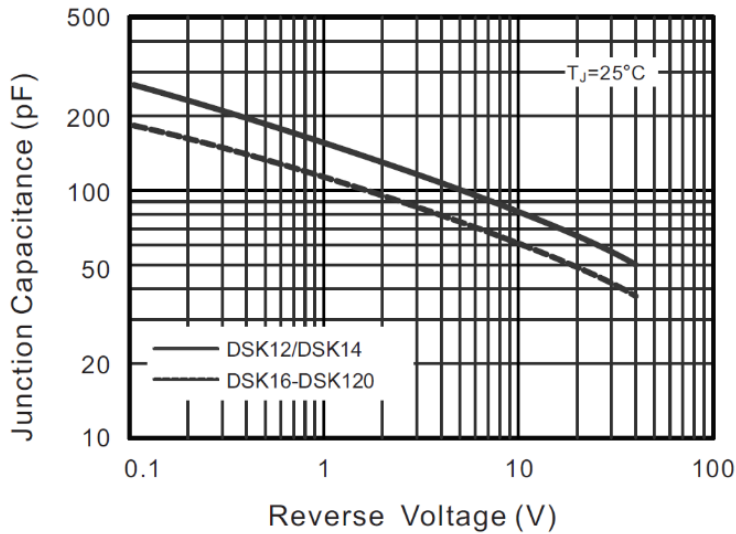

Fig.4 Typical Junction Capacitance



**SMD SCHOTTKY BARRIER RECTIFIER SOD-123FL SERIES**

**RATINGS AND CHARACTERISTIC CURVES (For Reference Only)**

**Fig.5 Maximum Non-Repetitive Peak Forward Surge Current**

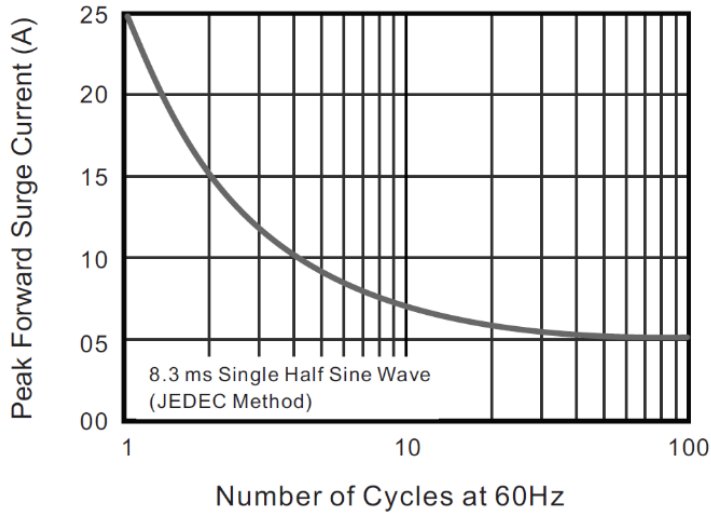

**Fig.6- Typical Transient Thermal Impedance**

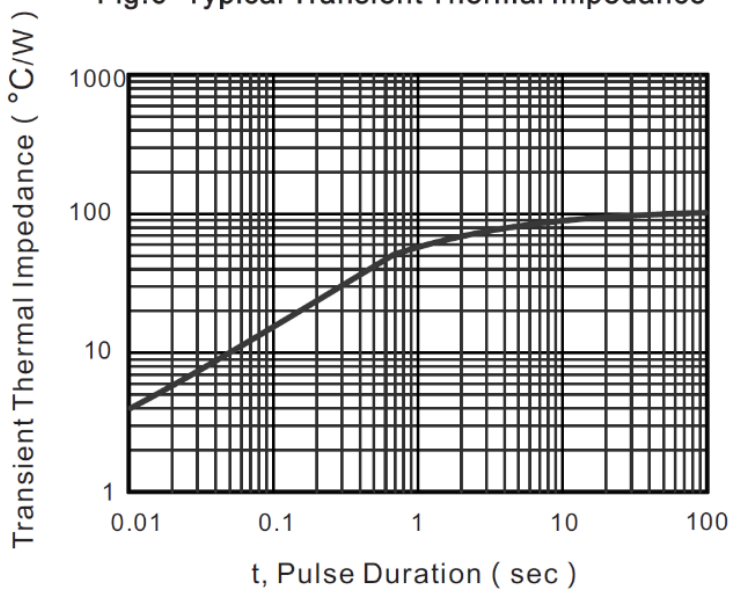

**SMD SCHOTTKY BARRIER RECTIFIER SOD-123FL SERIES**

**TAPE/REEL (Unit: mm)**

All Devices are packed in accordance with EIA standard RS-481-A and specifications.

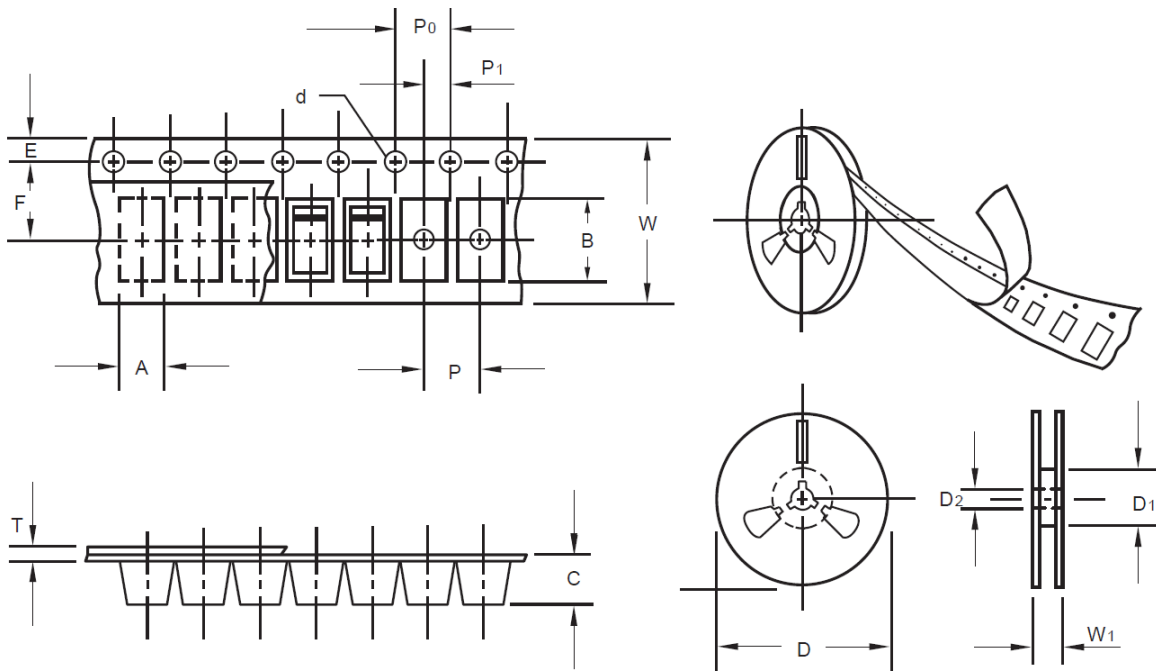

Item	Symbol	Tolerance	SOD-123FL
Carrier width	A	0.1	2.10
Carrier Length	B	0.1	4.00
Carrier Depth	C	0.1	1.60
Sprocket hole	d	0.05	1.55
7"Reel outside diameter	D	2.0	178.00
7"Reel inner diameter	D1	Min.	50.00
Feed hole diameter	D2	0.5	13.00
Sprocket hole position	E	0.1	1.75
Punch hole position	F	0.1	3.50
Punch hole pitch	P	0.1	4.00
Sprocket hole pitch	P0	0.1	4.00
Embossment center	P1	0.1	2.00
Overall tape thickness	T	0.1	0.25
Tape width	W	0.3	8.15
Reel width	W1	1.0	10.50

**SMD SCHOTTKY BARRIER RECTIFIER SOD-123FL SERIES**

**PACKAGE For Reference**



<b>Case Code</b>	SOD-123FL
Reel Size	7"
Reel Size	178 mm
MPQ/Reel	3000 pcs
Qty. /Box	6000 pcs
G.W/Box	1 lbs

**IMPORTANT NOTICE AND DISCLAIMER**







- 1) NextGen Component, Inc. reserves the right to make changes to this document and its products and specifications at any time without notice. Customers should obtain and confirm the latest product information and specifications before final design, purchase or use.
- 2) NextGen Component, Inc makes no warranty, representation or guarantee regarding the suitability of its products for any particular purpose, nor does NextGen Component, Inc assume any liability for application assistance or customer product design.
- 3) NextGen Component, Inc does not warrant or accept any liability with products which are purchased or used for any unintended or unauthorized application. No license is granted by implication or otherwise under any intellectual property rights of NextGen Component, Inc
- 4) NextGen Component, Inc. products are not authorized for use as critical components in life support devices or systems without express written approval of NextGen Component, Inc.

## Looking for pricing, stock, or lifecycle information?

Click below to explore more details on WIN SOURCE:

-  [View DSK110 on WIN SOURCE](#)
-  [MDD Information](#)

## Optimize Your Supply Chain with WIN SOURCE Solutions

-  Global Sourcing Solution
-  Obsolete Management
-  Cost Control Management
-  Shortage Management
-  Alternative Solution
-  Excess Inventory Management