



**THE DATASHEET OF
MAX9658AEE+**





Quad Video (Filter) Amplifiers with Input Sync-Tip Clamps

General Description

The MAX9657 is a small, low-power, quad video amplifier with input sync-tip clamps. It features a bandwidth of 15MHz, making it suitable for not only standard-definition video signals, but also video graphics array (VGA) signals with a 640 x 480 resolution at up to 85Hz refresh rate.

The MAX9658 is a quad video amplifier with integrated lowpass filters and input sync-tip clamps. The lowpass filters typically have ± 1 dB passband flatness out to 9.5MHz and 47dB attenuation at 27MHz. Specially suited for composite video signals, the MAX9658 is ideal for performing anti-alias filtering at the inputs of a digital video recorder or for performing reconstruction filtering at the outputs of a SCART set-top box.

Both devices require that the incoming video signals be AC-coupled to the inputs. The input sync-tip clamps set the internal DC level of the video signals.

The amplifiers have 2V/V gain, and the outputs can be DC-coupled to a 75 Ω load, which is the equivalent of two video loads, or AC-coupled to a 150 Ω load.

Both the MAX9657/MAX9658 feature a low-power shut-down mode, in which supply current is reduced to 35 μ A.

The MAX9657/MAX9658 operate from a single 2.7V to 3.6V supply, are specified over the -40 $^{\circ}$ C to +125 $^{\circ}$ C automotive temperature range, and are offered in a small, 16-pin QSOP package.

Applications

Set-Top Boxes
Digital Video Recorders

Typical Application Circuits and Pin Configuration appear at end of data sheet.

Features

- ◆ Quad Channel
- ◆ 9.5MHz, ± 1 dB Passband (MAX9658)
- ◆ 47dB Attenuation at 27MHz (MAX9658)
- ◆ Fixed Gain of 2V/V
- ◆ Low Power: 21mA
- ◆ 2.7V to 3.6V Single-Supply Operation

Ordering Information

PART	PIN-PACKAGE	STANDARD-DEFINITION VIDEO FILTER
MAX9657AEE+	16 QSOP	No
MAX9658AEE+	16 QSOP	Yes

Note: All devices are specified over the -40 $^{\circ}$ C to +125 $^{\circ}$ C operating temperature range.

+Denotes a lead(Pb)-free/RoHS-compliant package.

Functional Diagram

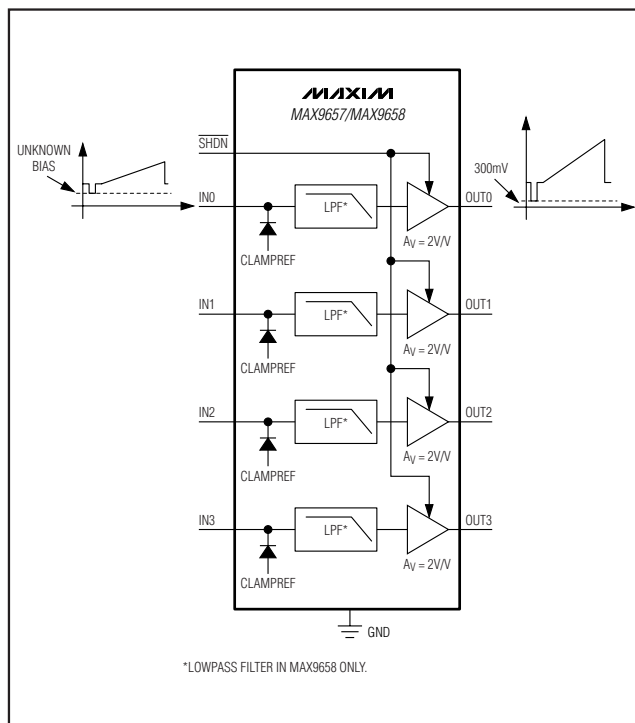

MAX9657/MAX9658

Quad Video (Filter) Amplifiers with Input Sync-Tip Clamps

ABSOLUTE MAXIMUM RATINGS

Supply Voltage		Continuous Power Dissipation ($T_A = +70^\circ\text{C}$)
V_{DD} to GND	-0.3V to +4V	16-Pin QSOP (derate 8.3mW/ $^\circ\text{C}$ above $+70^\circ\text{C}$)
Input Pins, $\overline{\text{SHDN}}$	(GND - 0.3V) to +4V	Operating Temperature Range
Duration of Output Short Circuit to V_{DD} or GND	Continuous	Junction Temperature
Continuous Input Current		Storage Temperature Range
Input Pins	$\pm 20\text{mA}$	Lead Temperature (soldering, 10s)

Stresses beyond those listed under "Absolute Maximum Ratings" may cause permanent damage to the device. These are stress ratings only, and functional operation of the device at these or any other conditions beyond those indicated in the operational sections of the specifications is not implied. Exposure to absolute maximum rating conditions for extended periods may affect device reliability.

ELECTRICAL CHARACTERISTICS

($V_{DD} = 3.3\text{V}$, $V_{GND} = 0\text{V}$, $\overline{\text{VSHDN}} = V_{DD}$, $R_L = 150\Omega$ to GND, $T_A = T_{MIN}$ to T_{MAX} , unless otherwise noted. Typical values are at $T_A = +25^\circ\text{C}$.) (Note 1)

PARAMETER	SYMBOL	CONDITIONS		MIN	TYP	MAX	UNITS
Supply Voltage Range	V_{DD}	Guaranteed by power-supply rejection test		2.7	3.3	3.6	V
Quiescent Supply Current	I_{DD}	No load			21	45	mA
Shutdown Supply Current	I_{SHDN}	$\overline{\text{SHDN}} = \text{GND}$			35	70	μA
Sync-Tip Clamp Level	V_{CCLP}			0.23	0.3	0.39	V
Input Voltage Range		Guaranteed by output-voltage swing	$2.7\text{V} \leq V_{DD} \leq 3.6\text{V}$			1.05	V_{P-P}
			$3.0\text{V} \leq V_{DD} \leq 3.6\text{V}$			1.2	
Sync Crush		Sync-tip clamp; percentage reduction in sync pulse (0.3 V_{P-P}); guaranteed by input clamping current measurement				2	%
Input Clamping Current					1	2	μA
Maximum Input Source Resistance					300		Ω
DC Voltage Gain (Note 2)	A_V	$R_L = 150\Omega$ to GND (Note 2)	$V_{DD} = 2.7\text{V}$, $0\text{V} \leq V_{IN} \leq 1.05\text{V}$	1.96	2	2.04	V/V
			$V_{DD} = 3\text{V}$, $0\text{V} \leq V_{IN} \leq 1.2\text{V}$	1.96	2	2.04	
DC Gain Mismatch		Guaranteed by DC voltage gain		-2		+2	%
Output Level		Measured at V_{OUT} , $C_{IN} = 0.1\mu\text{F}$ to GND		0.218	0.3	0.39	V
Output-Voltage Swing		Measured at output, $V_{DD} = 2.7\text{V}$, $V_{IN} = V_{CCLP}$ to $(V_{CCLP} + 1.05\text{V})$, $R_L = 150\Omega$ to -0.2V			2.1		V_{P-P}
		Measured at output, $V_{DD} = 2.7\text{V}$, $V_{IN} = V_{CCLP}$ to $(V_{CCLP} + 1.05\text{V})$, $R_L = 150\Omega$ to $V_{DD}/2$			2.1		
		Measured at output, $V_{DD} = 3.0\text{V}$, $V_{IN} = V_{CCLP}$ to $(V_{CCLP} + 1.2\text{V})$, $R_L = 150\Omega$ to -0.2V			2.4		
		Measured at output, $V_{DD} = 3.0\text{V}$, $V_{IN} = V_{CCLP}$ to $(V_{CCLP} + 1.2\text{V})$, $R_L = 150\Omega$ to $V_{DD}/2$			2.4		
		Measured at output, $V_{DD} = 3.135\text{V}$, $V_{IN} = V_{CCLP}$ to $(V_{CCLP} + 1.05\text{V})$, $R_L = 75\Omega$ to -0.2V			2.1		

Quad Video (Filter) Amplifiers with Input Sync-Tip Clamps

MAX9657/MAX9658

ELECTRICAL CHARACTERISTICS (continued)

($V_{DD} = 3.3V$, $V_{GND} = 0V$, $V_{SHDN} = V_{DD}$, $R_L = 150\Omega$ to GND, $T_A = T_{MIN}$ to T_{MAX} , unless otherwise noted. Typical values are at $T_A = +25^\circ C$.) (Note 1)

PARAMETER	SYMBOL	CONDITIONS	MIN	TYP	MAX	UNITS	
Output Short-Circuit Current		Short to GND (sourcing)		140		mA	
		Short to V_{DD} (sinking)		70			
Output Resistance	R_{OUT}	$V_{OUT} = 1.5V$, $-10mA \leq I_{LOAD} \leq +10mA$		0.2		Ω	
Power-Supply Rejection Ratio		$2.7V \leq V_{DD} \leq 3.6V$	48	64		dB	
		$f = 100kHz$, $100mV_{P-P}$		20			
Small-Signal Bandwidth		$V_{OUT} = 100mV_{P-P}$ (MAX9657 only)		27		MHz	
Large-Signal Bandwidth		$V_{OUT} = 2V_{P-P}$ (MAX9657 only)		15		MHz	
Slew Rate		MAX9657 only		65		V/ μs	
Settling Time		Settled to within 0.1% of final value (MAX9657 only)		75		ns	
Standard-Definition Reconstruction Filter		$V_{OUT} = 2V_{P-P}$, reference frequency is $100kHz \pm 1dB$ passband flatness (MAX9658 only)		9.5		MHz	
		$V_{OUT} = 2V_{P-P}$, reference frequency is $100kHz$ (MAX9658 only)	$f = 5.5MHz$		0.1		dB
			$f = 9.5MHz$		-1		
			$f = 10MHz$		-3		
$f = 27MHz$		-47					
Differential Gain	DG	5-step modulated staircase of 129mV step size and 286mV peak-to-peak subcarrier amplitude, $f = 4.43MHz$		0.4		%	
Differential Phase	DP	5-step modulated staircase of 129mV step size and 286mV peak-to-peak subcarrier amplitude, $f = 4.43MHz$		0.45		deg	
Group-Delay Distortion		$100kHz \leq f \leq 5MHz$, outputs are $2V_{P-P}$		9		ns	
Peak Signal to RMS Noise		$100kHz \leq f \leq 5MHz$		71		dB	
2T Pulse Response		$2T = 200ns$		0.2		K%	
2T Bar Response		$2T = 200ns$; bar time is $18\mu s$; the beginning 2.5%, and the ending 2.5% of the bar time is ignored		0.2		K%	
2T Pulse-to-Bar K Rating		$2T = 200ns$; bar time is $18\mu s$; the beginning 2.5%, and the ending 2.5% of the bar time is ignored		0.3		K%	
Nonlinearity		5-step staircase		0.1		%	
Output Impedance		$f = 5.5MHz$		8.07		Ω	
All-Hostile Crosstalk		$f = 15kHz$		-82		dB	
		$f = 4.43MHz$		-78			
Output-to-Input Crosstalk		$f = 30MHz$		-68		dB	

Quad Video (Filter) Amplifiers with Input Sync-Tip Clamps

ELECTRICAL CHARACTERISTICS (continued)

($V_{DD} = 3.3V$, $V_{GND} = 0V$, $V_{SHDN} = V_{DD}$, $R_L = 150\Omega$ to GND, $T_A = T_{MIN}$ to T_{MAX} , unless otherwise noted. Typical values are at $T_A = +25^\circ C$.) (Note 1)

PARAMETER	SYMBOL	CONDITIONS	MIN	TYP	MAX	UNITS
LOGIC SIGNALS (SHDN)						
Logic-Low Threshold	V_{IL}				$0.3 \times V_{DD}$	V
Logic-High Threshold	V_{IH}		$0.7 \times V_{DD}$			V
Logic Input Current	I_{IN}				10	μA

Note 1: All devices are 100% production tested at $T_A = +25^\circ C$. Specifications over temperature limits are guaranteed by design.

Note 2: Voltage gain (A_V) is a two-point measurement in which the output-voltage swing is divided by the input-voltage swing.

Typical Operating Characteristics (MAX9657)

($V_{DD} = 3.3V$, $V_{GND} = 0$, $V_{SHDN} = V_{DD}$, $R_L = 150\Omega$ to GND, $T_A = +25^\circ C$.)

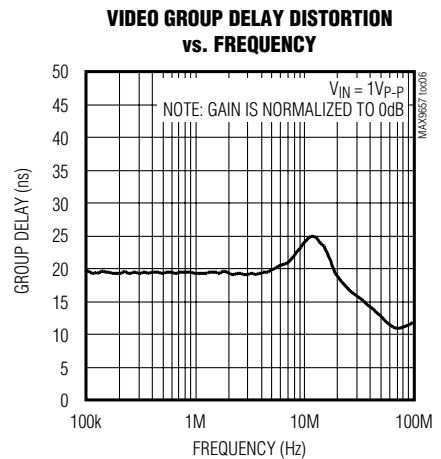
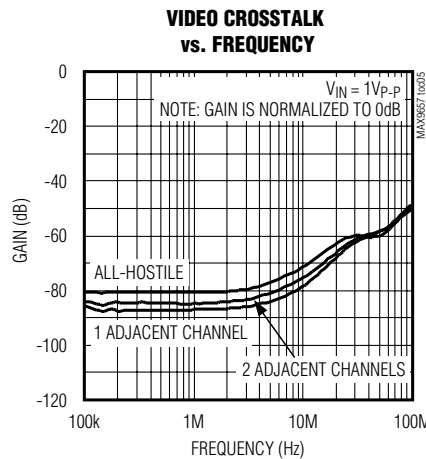
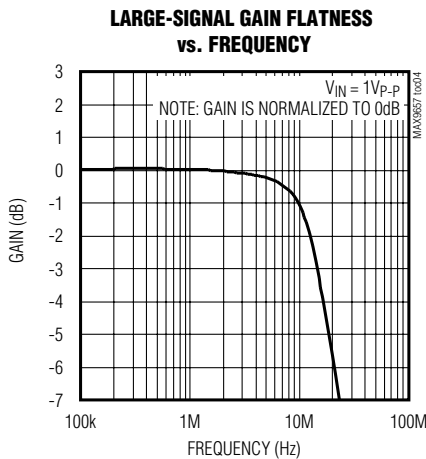
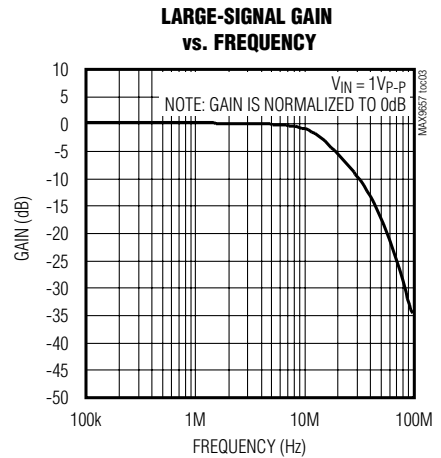
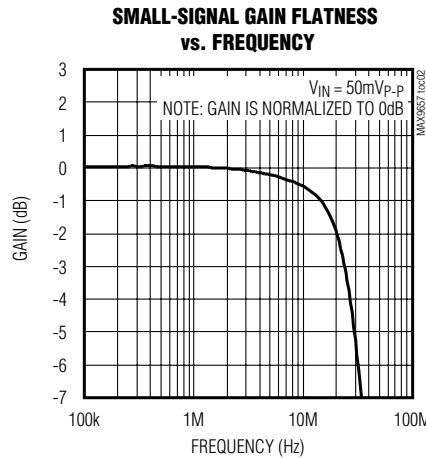
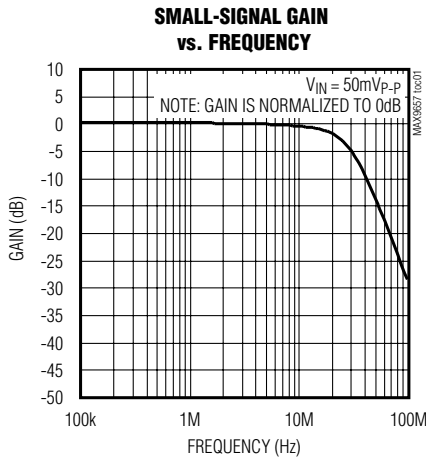

Quad Video (Filter) Amplifiers with Input Sync-Tip Clamps

Typical Operating Characteristics (MAX9657) (continued)

($V_{DD} = 3.3V$, $V_{GND} = 0$, $V_{SHDN} = V_{DD}$, $R_L = 150\Omega$ to GND, $T_A = +25^\circ C$.)

MAX9657/MAX9658

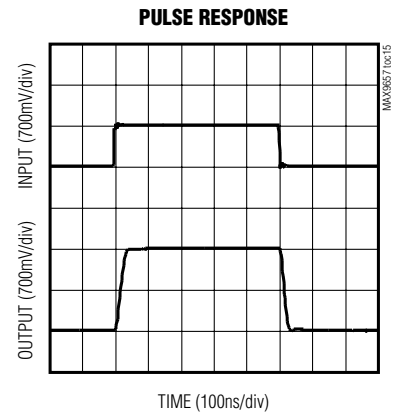
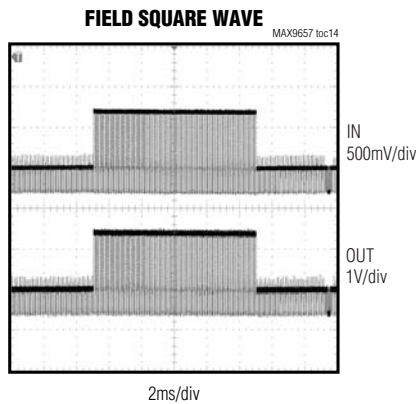
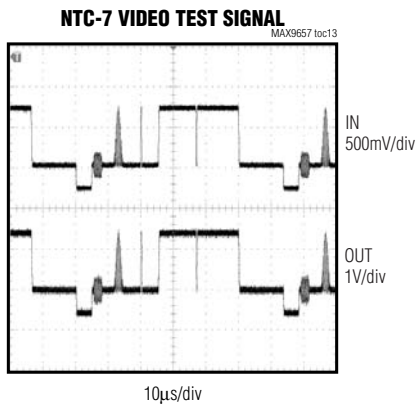
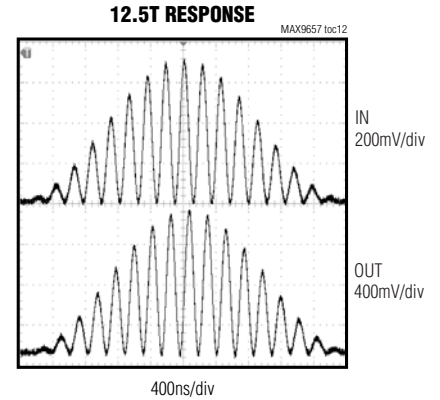
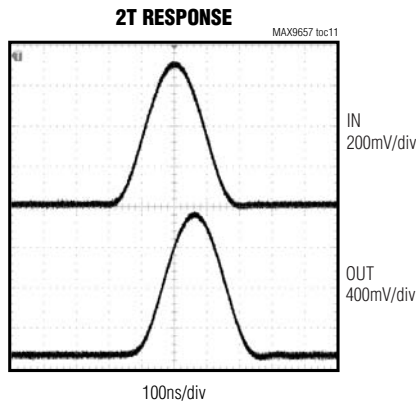
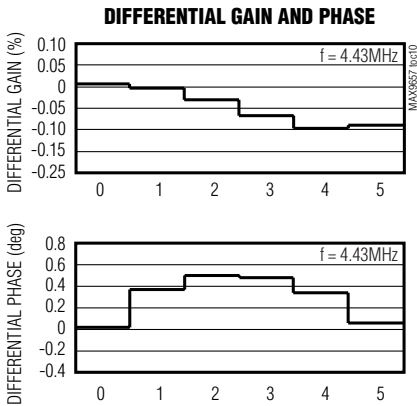
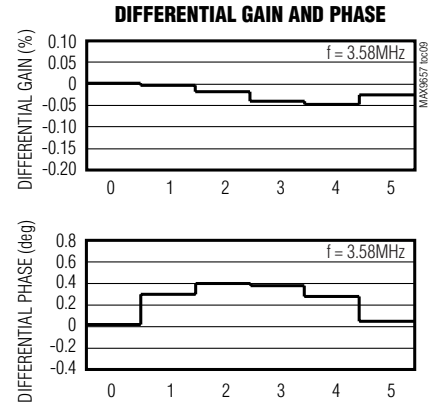
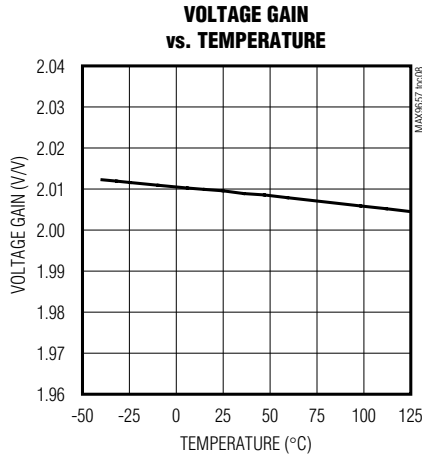
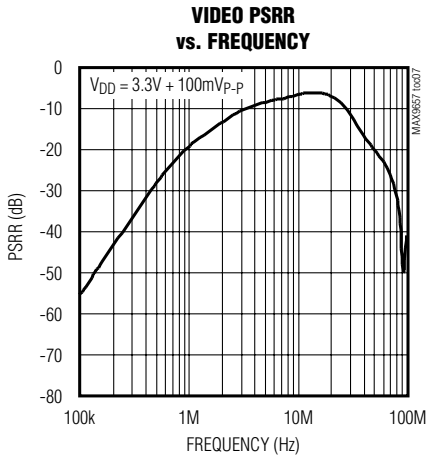

Quad Video (Filter) Amplifiers with Input Sync-Tip Clamps

Typical Operating Characteristics (MAX9657) (continued)

($V_{DD} = 3.3V$, $V_{GND} = 0$, $V_{SHDN} = V_{DD}$, $R_L = 150\Omega$ to GND, $T_A = +25^\circ C$.)

VIDEO SYNC-TIP CLAMP VOLTAGE vs. TEMPERATURE

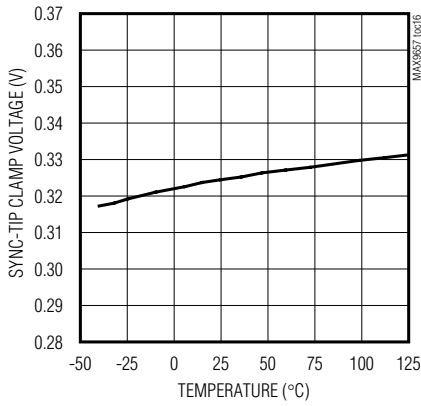

VIDEO SYNC-TIP CLAMP CURRENT vs. TEMPERATURE

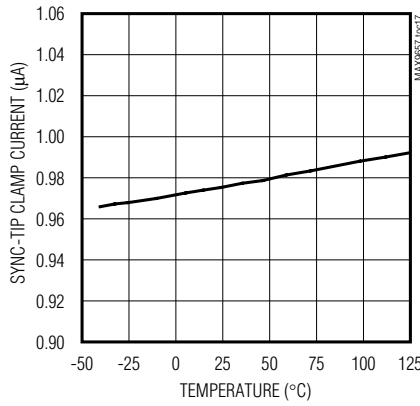

SYNC-TIP CLAMP CURRENT vs. INPUT VOLTAGE

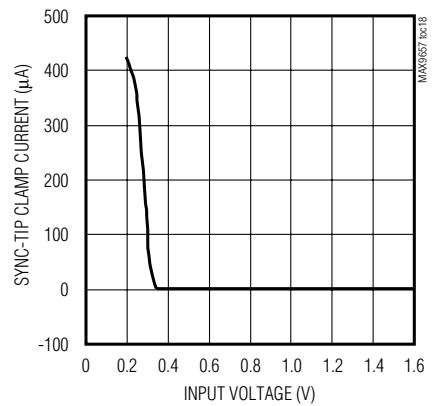

QUIESCENT SUPPLY CURRENT vs. TEMPERATURE

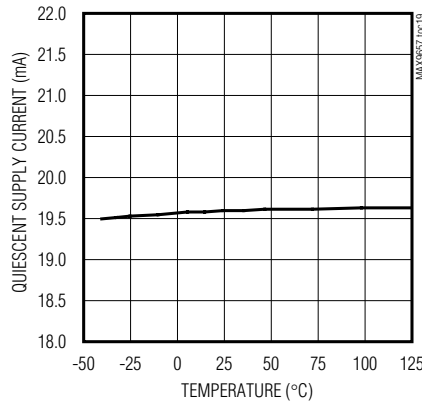

Quad Video (Filter) Amplifiers with Input Sync-Tip Clamps

Typical Operating Characteristics (MAX9658) (continued)

($V_{DD} = 3.3V$, $V_{GND} = 0$, $V_{SHDN} = V_{DD}$, $R_L = 150\Omega$ to GND, $T_A = +25^\circ C$.)

MAX9657/MAX9658

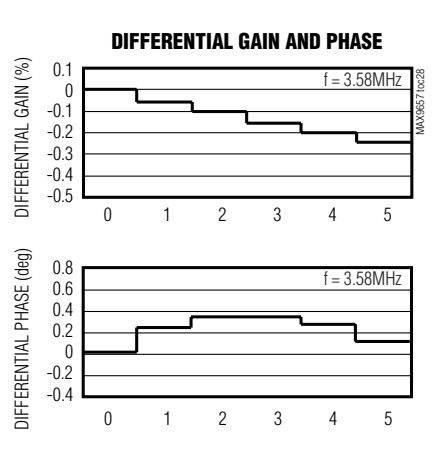
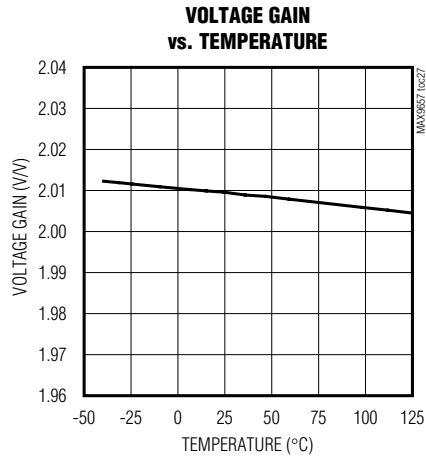
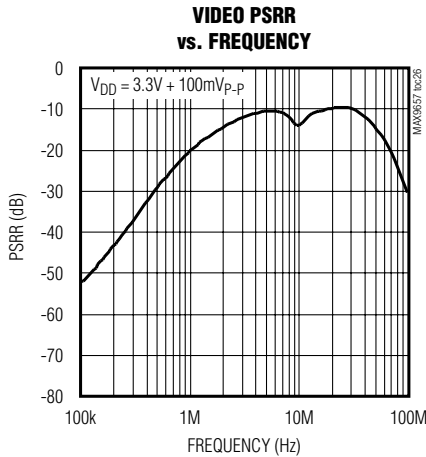
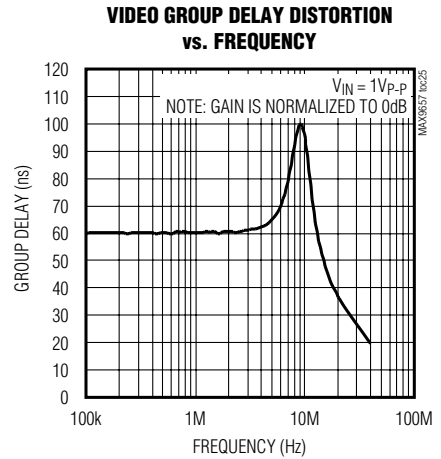
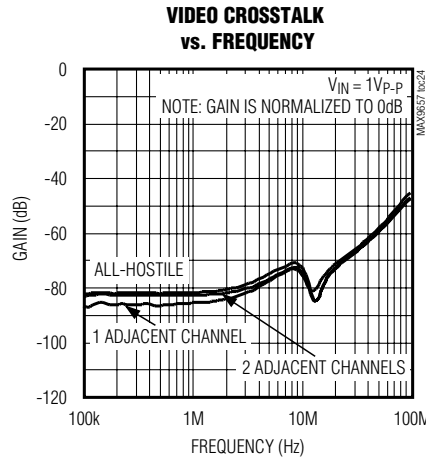
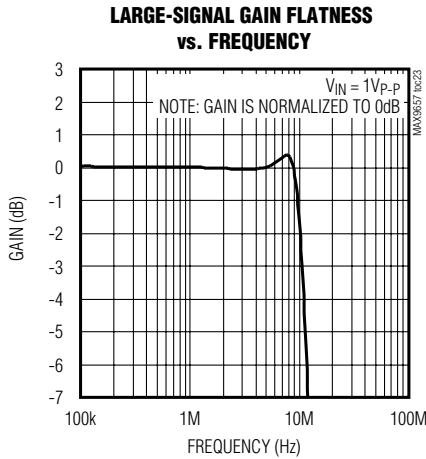
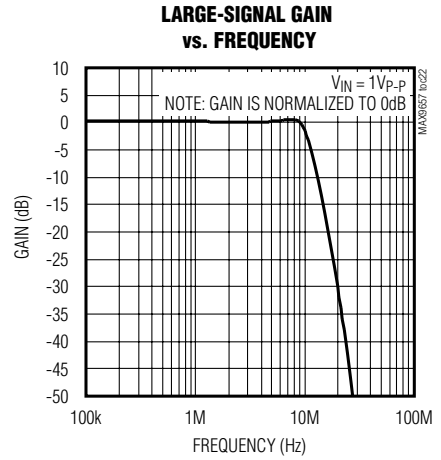
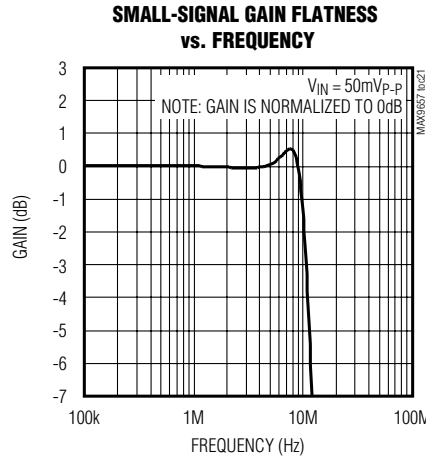
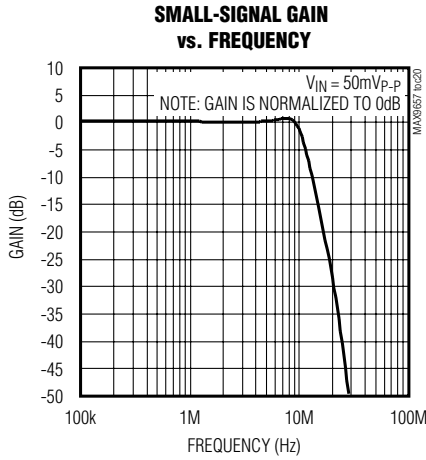

Quad Video (Filter) Amplifiers with Input Sync-Tip Clamps

Typical Operating Characteristics (MAX9658) (continued)

($V_{DD} = 3.3V$, $V_{GND} = 0$, $V_{SHDN} = V_{DD}$, $R_L = 150\Omega$ to GND, $T_A = +25^\circ C$.)

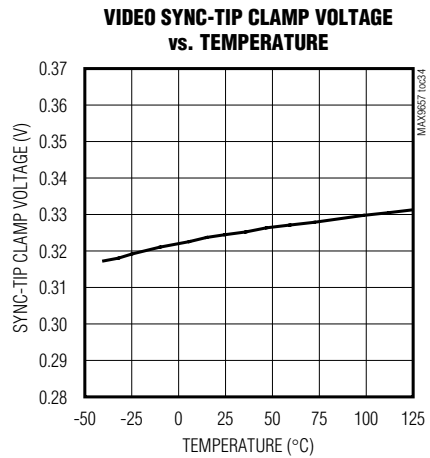
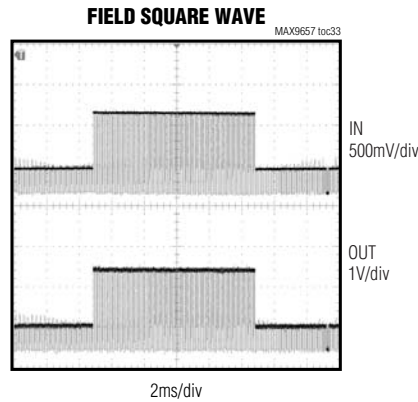
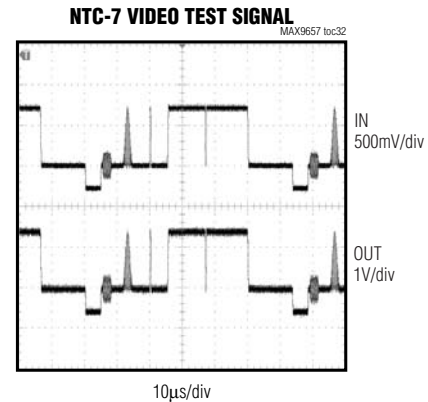
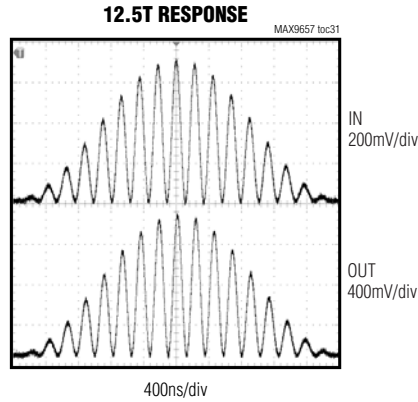
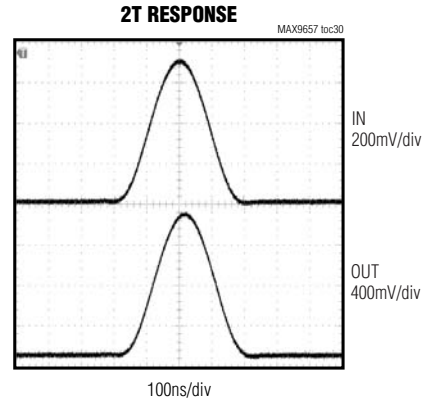
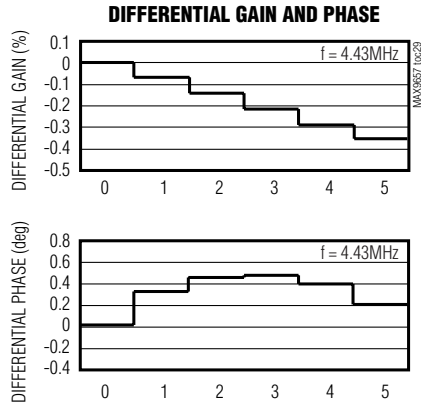

Quad Video (Filter) Amplifiers with Input Sync-Tip Clamps

Typical Operating Characteristics (MAX9658) (continued)

($V_{DD} = 3.3V$, $V_{GND} = 0$, $V_{SHDN} = V_{DD}$, $R_L = 150\Omega$ to GND, $T_A = +25^\circ C$.)

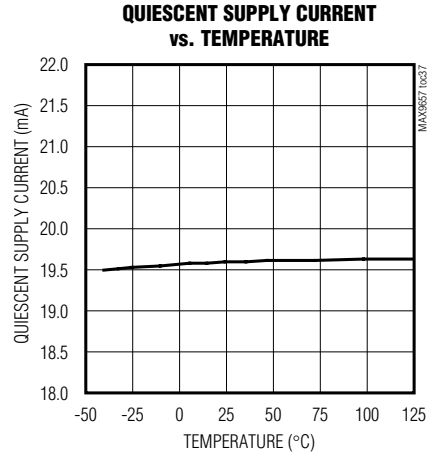
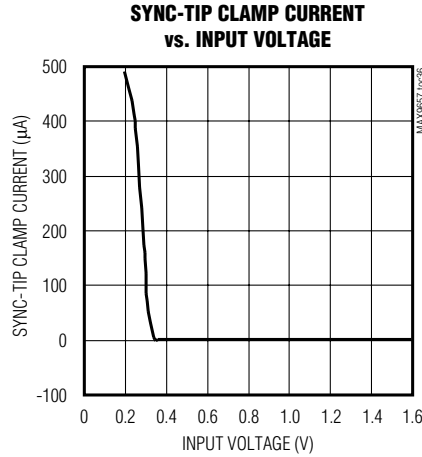
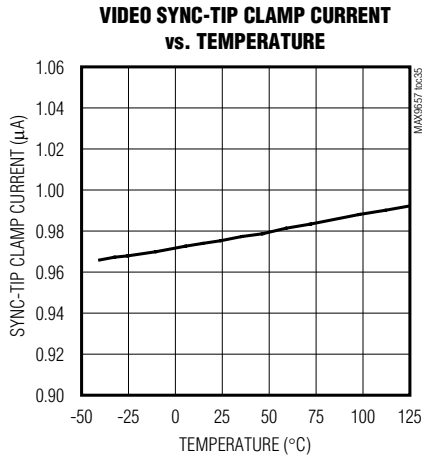

MAX9657/MAX9658

Pin Description

PIN	NAME	FUNCTION
1	IN0	Video Input Channel 0
2	IN1	Video Input Channel 1
3	IN2	Video Input Channel 2
4	IN3	Video Input Channel 3
5–8, 15	N.C.	No Connection. Not internally connected.
9	GND	Ground
10	\overline{SHDN}	Active-Low Shutdown Logic Input. Connect to GND to place device in shutdown. Connect to V_{DD} for normal operation.
11	OUT3	Video Output Channel 3
12	OUT2	Video Output Channel 2
13	OUT1	Video Output Channel 1
14	OUT0	Video Output Channel 0
16	V_{DD}	Positive Power Supply. Bypass to GND with a 0.1µF capacitor.

Quad Video (Filter) Amplifiers with Input Sync-Tip Clamps

Detailed Description

The MAX9657 consists of input sync-tip clamps and gain of 2V/V output amplifiers capable of driving standard 150Ω loads to ground. It can be used to buffer video signals, for example, before a crosspoint matrix.

The MAX9658 filters and amplifies video signals. It is very similar to the MAX9657 except that it also has integrated lowpass filters. This device can be used to provide the anti-alias filtering before the video decoders of a digital video recorder, or it can be used to do the reconstruction filtering after a video DAC that references output signals to the positive supply.

Input

The MAX9657/MAX9658 feature sync-tip clamps at the input that accept video signals with sync pulses. Composite video with blanking and sync (CVBS) is an example of a video signal with sync pulses. The sync-tip voltage is internally set to 300mV.

In shutdown mode, the inputs to the MAX9657/MAX9658 do not distort the video signal in case the video source is driving video signals to another video circuit such as a video multiplexer. The inputs in shutdown mode are biased at $V_{DD}/3$, which is sufficiently above ground such that the ESD diodes never forward bias as the video signal changes. The input resistance is 220kΩ, which presents negligible loading on the video current DAC.

Video Filter (MAX9658 Only)

The MAX9658 filters feature ±1dB passband out to 9.5MHz and 47dB attenuation at 27MHz, making the filter suitable for standard-definition video signals from all sources (e.g., broadcast and DVD). Broadcast video signals are channel limited: NTSC signals have 4.2MHz bandwidth and PAL signals have 5MHz bandwidth. Video signals from a DVD player, however, are not channel limited, so the bandwidth of DVD video signals can approach the Nyquist limit of 6.75MHz. Recommendation: ITU-R BT.601-5 specifies 13.5MHz as the sampling rate for standard-definition video. Therefore, the maximum bandwidth of the signal is 6.75MHz. To ease the filtering requirements, most modern video systems oversample by two times, clocking the video current DAC at 27MHz.

Outputs

The video output amplifiers can both source and sink load current, allowing output loads to be DC- or AC-coupled. The amplifier output stage needs approximately 300mV of headroom from either supply rail. The devices have an internal level-shift circuit that positions the sync tip at approximately 300mV at the output.

If the supply voltage is greater than 3.135V (5% below a 3.3V supply), each amplifier can drive two DC-coupled video loads to ground. If the supply is less than 3.135V, each amplifier can drive only one DC-coupled or AC-coupled video load.

Shutdown

The devices draw approximately 35μA of supply current when $\overline{\text{SHDN}}$ is low. In shutdown mode, the amplifier outputs become high impedance.

Applications Information

AC-Coupling the Outputs

The outputs can be AC-coupled since the output stage can source and sink current as shown in Figure 1. Coupling capacitors should be 220μF or greater to keep the highpass filter, formed by the 150Ω equivalent resistance of the video transmission line, to a corner frequency of 4.8Hz or below. The frame rate of PAL systems is 25Hz, the frame rate of NTSC systems is 30Hz, and the frame rate of VGA is usually 60Hz or higher. The corner frequency should be well below the frame rate.

Power Consumption

The quiescent power consumption and average power consumption of the MAX9657/MAX9658 are very low because of the 3.3V operation and low-power circuit design. Quiescent power consumption is defined when the MAX9657/MAX9658 are operating without loads and without any video signals.

Average power consumption represents the normal power consumption when the devices drive real video signals into real video loads. It is measured when the MAX9657/MAX9658 drive a 150Ω load to ground with a 50% flat field, which serves as a proxy for a real video signal.

Table 1 shows the quiescent and average power consumption of the MAX9657/MAX9658.

Power-Supply Bypassing and Ground

The MAX9657/MAX9658 operate from a single-supply voltage down to 2.7V, allowing for low-power operation. Bypass V_{DD} to GND with a 0.1μF capacitor. Place all external components as close as possible to the device.

Quad Video (Filter) Amplifiers with Input Sync-Tip Clamps

MAX9657/MAX9658

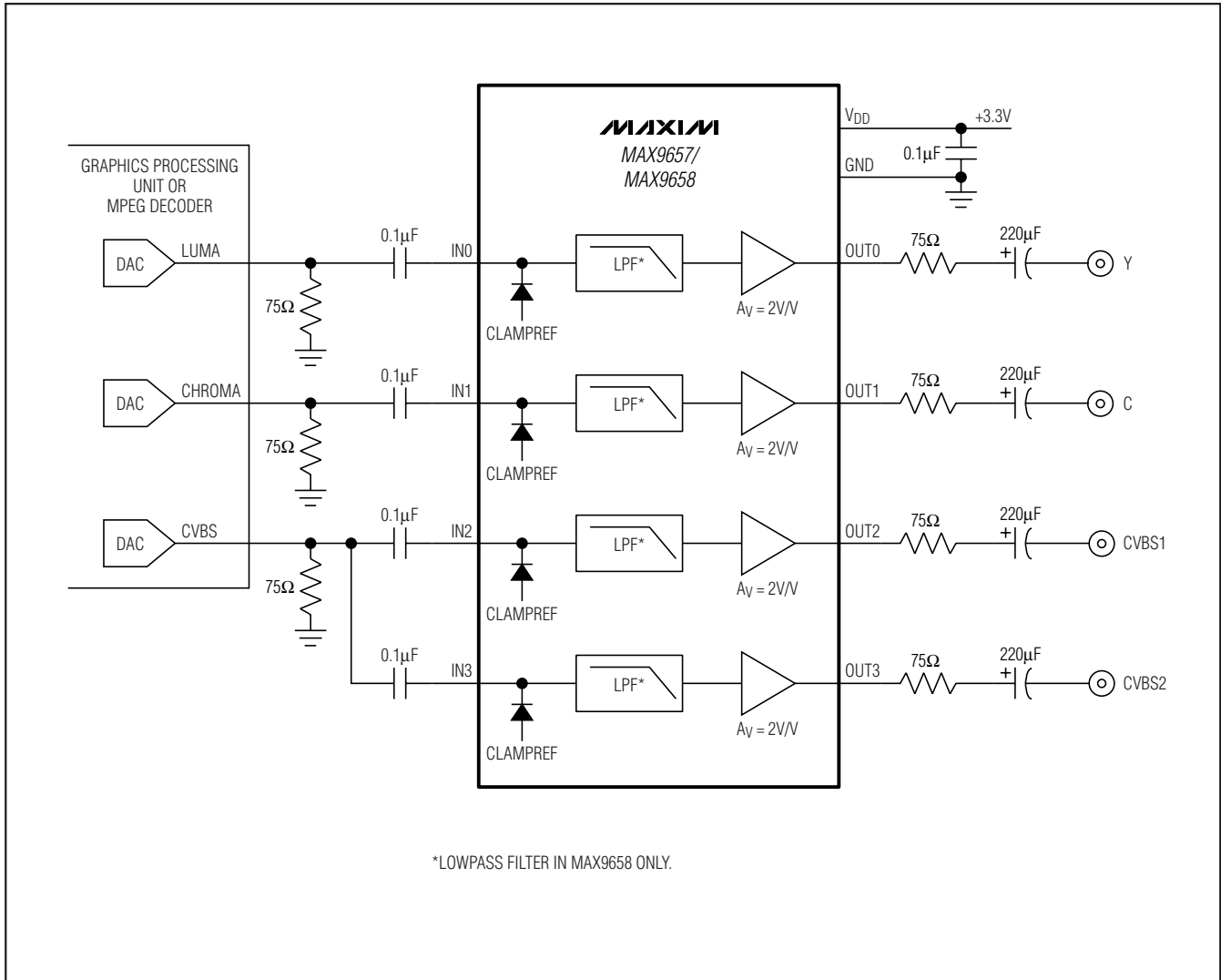

Figure 1. AC-Coupled Outputs

Table 1. Quiescent and Average Power Consumption for MAX9657/MAX9658

MEASUREMENT	POWER CONSUMPTION (mW)	CONDITIONS
Quiescent power consumption	69	No load.
Average power consumption	200	150Ω to ground on each output. 50% flat field signal on each input.

Quad Video (Filter) Amplifiers with Input Sync-Tip Clamps

Typical Application Circuits

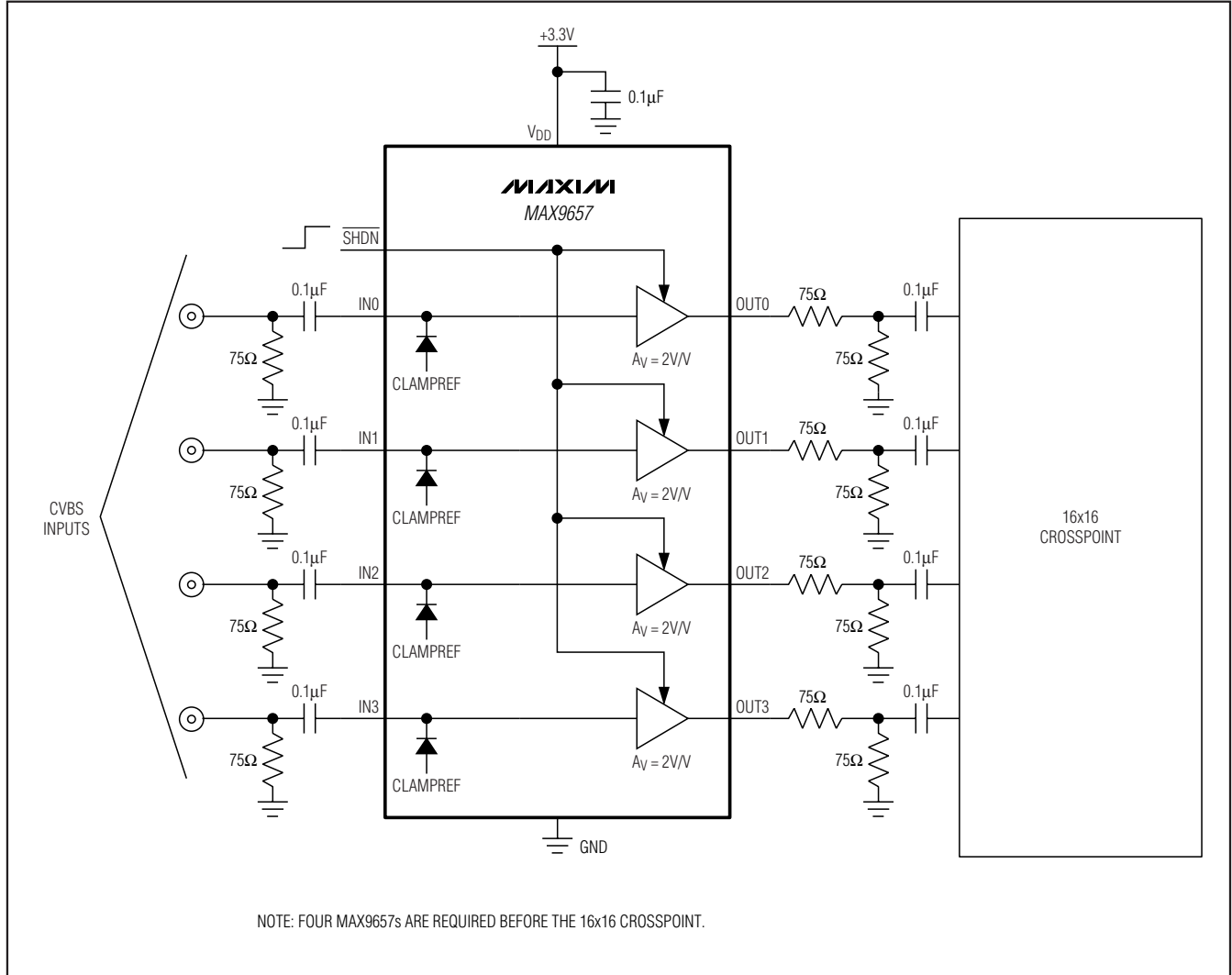

Quad Video (Filter) Amplifiers with Input Sync-Tip Clamps

Typical Application Circuits (continued)

MAX9657/MAX9658

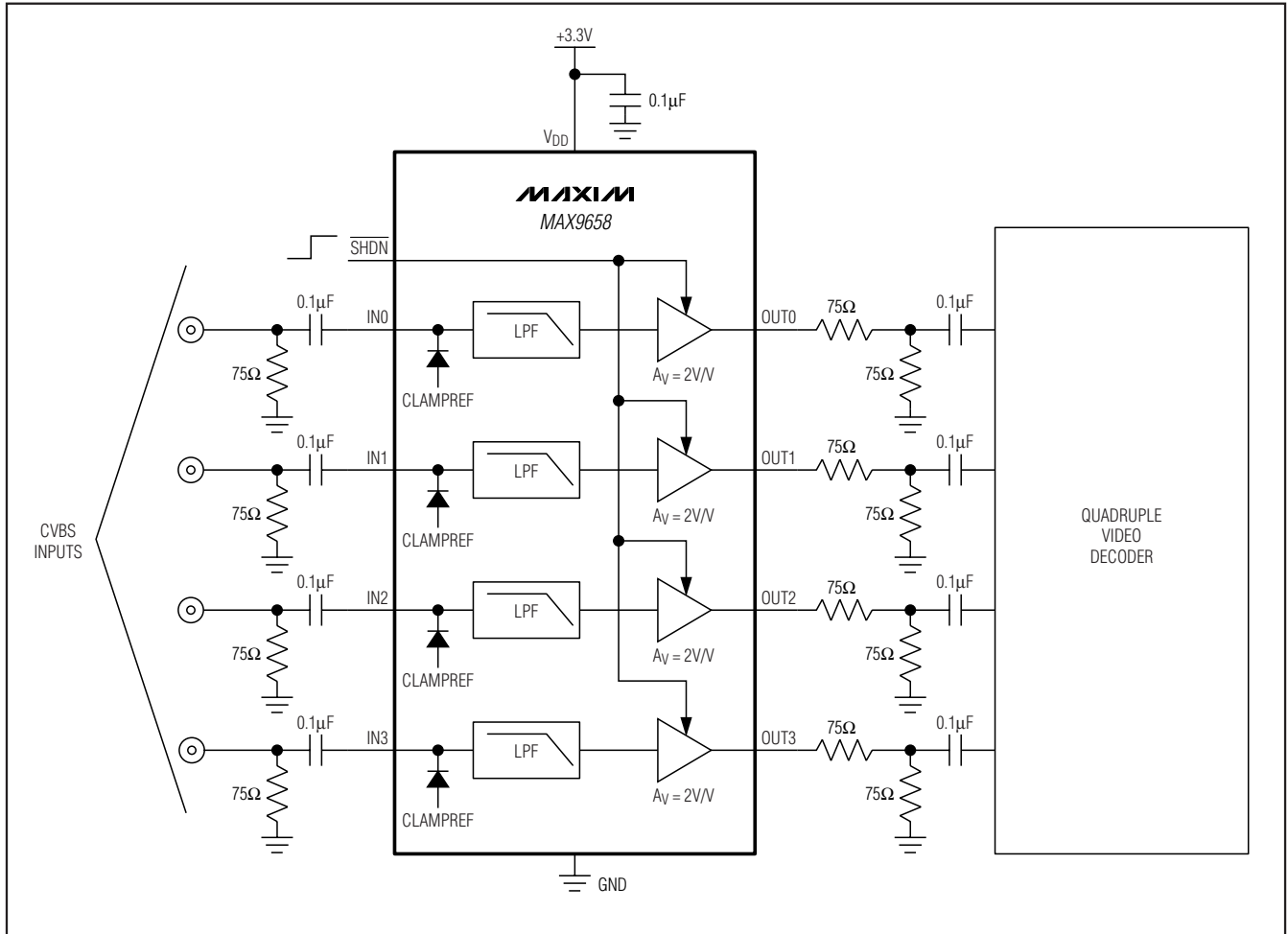

Quad Video (Filter) Amplifiers with Input Sync-Tip Clamps

Pin Configuration

Chip Information

PROCESS: BiCMOS

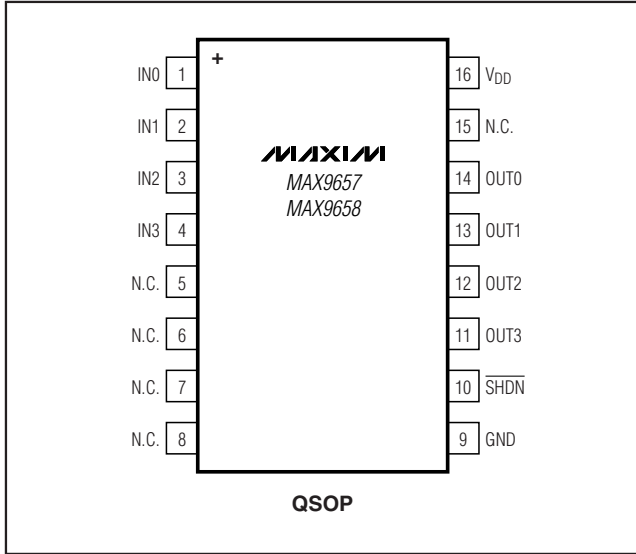

Quad Video (Filter) Amplifiers with Input Sync-Tip Clamps

Package Information

For the latest package outline information and land patterns, go to www.maxim-ic.com/packages.

PACKAGE TYPE	PACKAGE CODE	DOCUMENT NO.
16 QSOP	E16-4	21-0055

MAX9657/MAX9658

TOP VIEW

SIDE VIEW

DIM	INCHES		MILLIMETERS	
	MIN	MAX	MIN	MAX
A	.053	.069	1.35	1.75
A1	.004	.010	.102	.254
A2	.049	.065	1.245	1.651
B	.008	.012	0.20	0.30
C	.0075	.0098	0.191	0.249
D	SEE VARIATIONS			
E	.150	.157	3.81	3.99
e	.025 BSC		0.635 BSC	
H	.230	.244	5.84	6.20
h	.010	.016	0.25	0.41
L	.016	.035	0.41	0.89
N	SEE VARIATIONS			
alpha	0°	8°	0°	8°

VARIATIONS:

DIM	INCHES		MILLIMETERS		N	PKG CODES
	MIN.	MAX.	MIN.	MAX.		
D	.189	.196	4.80	4.98	16	E16-1, E16M-1, E16-4, E16-5, E16-6, E16-8F
S	.0020	.0070	0.05	0.18		
D	.337	.344	8.56	8.74	20	E20-1, E20-2
S	.0500	.0550	1.270	1.397		
D	.337	.344	8.56	8.74	24	E24-1, E24-2
S	.0250	.0300	0.635	0.762		
D	.386	.393	9.80	9.98	28	E28-1, E28M-1, E28-2
S	.0250	.0300	0.635	0.762		

NOTES:

- D & E DO NOT INCLUDE MOLD FLASH OR PROTRUSIONS.
- MOLD FLASH OR PROTRUSIONS NOT TO EXCEED .006" PER SIDE.
- CONTROLLING DIMENSIONS: INCHES.
- MEETS JEDEC MO137.
- MARKING SHOWN IS FOR PKG. ORIENTATION ONLY.
- ALL DIMENSIONS APPLY TO BOTH LEADED (-) AND PkFREE (+) PKG. CODES.

-DRAWING NOT TO SCALE-

TITLE:
PACKAGE OUTLINE
QSOP .150", .025" LEAD PITCH

APPROVAL	DOCUMENT CONTROL NO.	REV.	1/1
	21-0055	H	

Maxim cannot assume responsibility for use of any circuitry other than circuitry entirely embodied in a Maxim product. No circuit patent licenses are implied. Maxim reserves the right to change the circuitry and specifications without notice at any time.

Maxim Integrated Products, 120 San Gabriel Drive, Sunnyvale, CA 94086 408-737-7600 _____ 15

Looking for pricing, stock, or lifecycle information?

Click below to explore more details on WIN SOURCE:

 [View MAX9658AEE+ on WIN SOURCE](#)

 [Maxim Integrated](#) Information

Optimize Your Supply Chain with WIN SOURCE Solutions

-  Global Sourcing Solution
-  Obsolete Management
-  Cost Control Management
-  Shortage Management
-  Alternative Solution
-  Excess Inventory Management