



**THE DATASHEET OF
LQH6PPN470M43L**



Chip Inductor (Chip Coil) Power Inductor (Wire Wound Type)

LQH6PP Series (2424 Size)

■ Dimensions

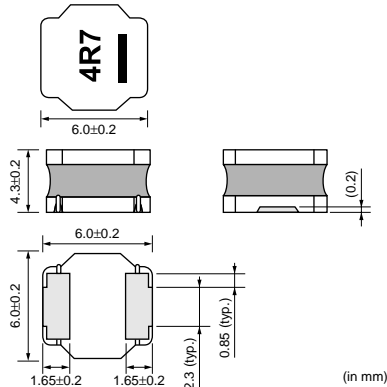

■ Packaging

Code	Packaging	Minimum Quantity
L	180mm Embossed Tape	250
K	330mm Embossed Tape	1500

■ Rated Value (□: packaging code)

Part Number	Inductance	Rated Current (Based on Inductance Change)	Rated Current (Based on Temperature Rise)	DC Resistance	Self Resonance Frequency (min.)
LQH6PPN1R0N43□	1.0μH±30%	7.50A	4.30A	0.009ohm±30%	110MHz
LQH6PPN1R5N43□	1.5μH±30%	6.50A	4.15A	0.010ohm±30%	60MHz
LQH6PPN2R2N43□	2.2μH±30%	5.60A	4.10A	0.014ohm±30%	30MHz
LQH6PPN3R3N43□	3.3μH±30%	4.50A	3.80A	0.016ohm±30%	30MHz
LQH6PPN4R7M43□	4.7μH±20%	4.00A	3.20A	0.020ohm±30%	25MHz
LQH6PPN6R8M43□	6.8μH±20%	3.20A	2.85A	0.028ohm±30%	20MHz
LQH6PPN100M43□	10μH±20%	2.60A	2.60A	0.044ohm±30%	15MHz
LQH6PPN150M43□	15μH±20%	2.20A	2.20A	0.065ohm±30%	10MHz
LQH6PPN220M43□	22μH±20%	1.70A	1.55A	0.108ohm±30%	10MHz
LQH6PPN330M43□	33μH±20%	1.60A	1.29A	0.137ohm±30%	6MHz
LQH6PPN470M43□	47μH±20%	1.25A	1.10A	0.230ohm±30%	6MHz
LQH6PPN680M43□	68μH±20%	1.10A	1.00A	0.289ohm±30%	5MHz
LQH6PPN101M43□	100μH±20%	0.92A	0.80A	0.436ohm±30%	3MHz

Test Frequency: 100kHz Class of Magnetic Shield: Magnetic shield of magnetic powder in resin

Operating Temperature Range (Self-temperature rise is included): -40°C to +125°C

Operating Temperature Range (Self-temperature rise is not included): -40°C to +85°C

Only for reflow soldering.

Continued on the following page. 

● This data sheet is applied for CHIP INDUCTORS (CHIP COILS) used for General Electronics equipment for your design.

⚠ Note:

1. This datasheet is downloaded from the website of Murata Manufacturing co., Ltd. Therefore, it's specifications are subject to change or our products in it may be discontinued without advance notice. Please check with our sales representatives or product engineers before ordering.
2. This datasheet has only typical specifications because there is no space for detailed specifications. Therefore, please approve our product specifications or transact the approval sheet for product specifications before ordering.

 Continued from the preceding page.

■ Notice (Rated Current)

<Rated Current>

(Based on Inductance Change)

When Rated Current is applied to the Products,
Inductance will be within $\pm 30\%$ of nominal
Inductance value.

<Rated Current>

(Based on Temperature Rise)

When Rated Current is applied to the Products,
self-generation of heat will rise to 40°C or less.

■ Inductance-Frequency Characteristics (Typ.)

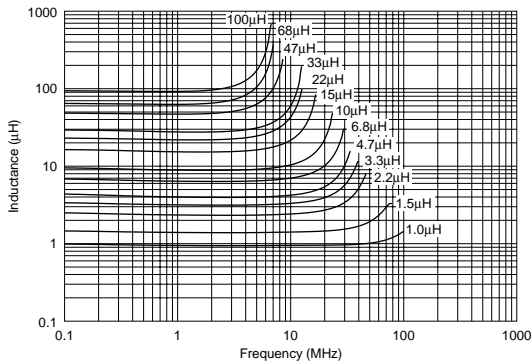

■ Inductance-Current Characteristics (Typ.)

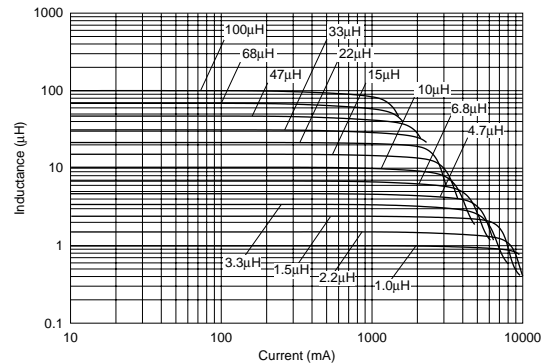

■ Temperature Rise Characteristics (Typ.)

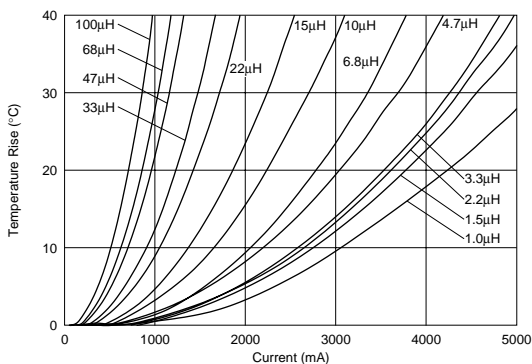

■ ⚠ Caution/Notice

⚠ Caution (Rating)

Do not use products beyond the rated current as
this may create excessive heat.

Notice

Solderability of Tin plating termination chip might be
deteriorated when low temperature soldering profile
where peak solder temperature is below the Tin melting
point is used. Please confirm the solderability of Tin
plating termination chip before use.



● This data sheet is applied for CHIP INDUCTORS (CHIP COILS) used for General Electronics equipment for your design.

⚠ Note:







1. This datasheet is downloaded from the website of Murata Manufacturing co., Ltd. Therefore, it's specifications are subject to change or our products in it may be discontinued without advance notice. Please check with our sales representatives or product engineers before ordering.
2. This datasheet has only typical specifications because there is no space for detailed specifications. Therefore, please approve our product specifications or transact the approval sheet for product specifications before ordering.

Looking for pricing, stock, or lifecycle information?

Click below to explore more details on WIN SOURCE:

-  [View LQH6PPN470M43L on WIN SOURCE](#)
-  [Murata Electronics North America Information](#)

Optimize Your Supply Chain with WIN SOURCE Solutions

-  Global Sourcing Solution
-  Obsolete Management
-  Cost Control Management
-  Shortage Management
-  Alternative Solution
-  Excess Inventory Management