

Features

- **Low-voltage and Standard-voltage Operation**
 - 5.0 ($V_{CC} = 4.5V$ to $5.5V$)
 - 2.7 ($V_{CC} = 2.7V$ to $5.5V$)
 - 2.5 ($V_{CC} = 2.5V$ to $5.5V$)
 - 1.8 ($V_{CC} = 1.8V$ to $5.5V$)
- **User-selectable Internal Organization**
 - 1K: 128 x 8 or 64 x 16
 - 2K: 256 x 8 or 128 x 16
 - 4K: 512 x 8 or 256 x 16
- **3-wire Serial Interface**
- **2 MHz Clock Rate (5V) Compatibility**
- **Self-timed Write Cycle (10 ms max)**
- **High Reliability**
 - **Endurance: 1 Million Write Cycles**
 - **Data Retention: 100 Years**
 - **ESD Protection: >4000V**
- **Automotive Grade and Extended Temperature Devices Available**
- **8-pin PDIP, 8-lead JEDEC and EIAJ SOIC, and 8-lead TSSOP Packages**

Description

The AT93C46/56/57/66 provides 1024/2048/4096 bits of serial electrically erasable programmable read only memory (EEPROM) organized as 64/128/256 words of 16 bits each, when the ORG pin is connected to V_{CC} and 128/256/512 words of 8 bits each when it is tied to ground. The device is optimized for use in many industrial and commercial applications where low power and low voltage operations are essential. The AT93C46/56/57/66 is available in space saving 8-pin PDIP and 8-lead JEDEC and EIAJ SOIC packages.

(continued)

Pin Configurations

Pin Name	Function
CS	Chip Select
SK	Serial Data Clock
DI	Serial Data Input
DO	Serial Data Output
GND	Ground
VCC	Power Supply
ORG	Internal Organization
DC	Don't Connect

8-pin PDIP

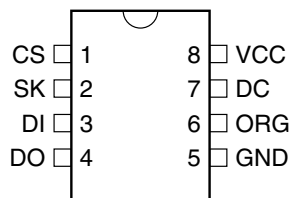

8-lead SOIC

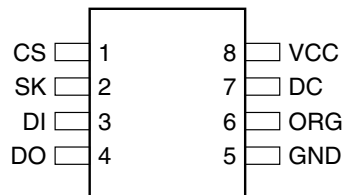

8-lead SOIC
Rotated (R)
(1K JEDEC Only)

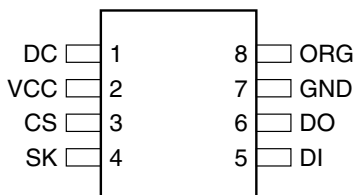

8-lead TSSOP

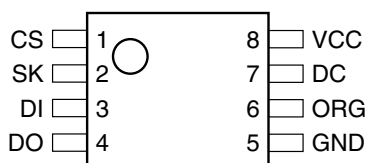

3-wire Serial EEPROMs

1K (128 x 8 or 64 x 16)

2K (256 x 8 or 128 x 16)

4K (512 x 8 or 256 x 16)

AT93C46

AT93C56

AT93C57

AT93C66



Pin Capacitance⁽¹⁾

Applicable over recommended operating range from $T_A = 25^\circ\text{C}$, $f = 1.0\text{ MHz}$, $V_{CC} = +5.0\text{V}$ (unless otherwise noted).

Symbol	Test Conditions	Max	Units	Conditions
C_{OUT}	Output Capacitance (DO)	5	pF	$V_{OUT} = 0\text{V}$
C_{IN}	Input Capacitance (CS, SK, DI)	5	pF	$V_{IN} = 0\text{V}$

Note: 1. This parameter is characterized and is not 100% tested.

DC Characteristics

Applicable over recommended operating range from: $T_{AI} = -40^\circ\text{C}$ to $+85^\circ\text{C}$, $V_{CC} = +1.8\text{V}$ to $+5.5\text{V}$, $T_{AC} = 0^\circ\text{C}$ to $+70^\circ\text{C}$, $V_{CC} = +1.8\text{V}$ to $+5.5\text{V}$ (unless otherwise noted).

Symbol	Parameter	Test Condition	Min	Typ	Max	Unit
V_{CC1}	Supply Voltage		1.8		5.5	V
V_{CC2}	Supply Voltage		2.5		5.5	V
V_{CC3}	Supply Voltage		2.7		5.5	V
V_{CC4}	Supply Voltage		4.5		5.5	V
I_{CC}	Supply Current	$V_{CC} = 5.0\text{V}$	READ at 1.0 MHz	0.5	2.0	mA
			WRITE at 1.0 MHz	0.5	2.0	mA
I_{SB1}	Standby Current	$V_{CC} = 1.8\text{V}$	CS = 0V	0	0.1	μA
I_{SB2}	Standby Current	$V_{CC} = 2.5\text{V}$	CS = 0V	6.0	10.0	μA
I_{SB3}	Standby Current	$V_{CC} = 2.7\text{V}$	CS = 0V	6.0	10.0	μA
I_{SB4}	Standby Current	$V_{CC} = 5.0\text{V}$	CS = 0V	17	30	μA
I_{IL}	Input Leakage	$V_{IN} = 0\text{V}$ to V_{CC}		0.1	1.0	μA
I_{OL}	Output Leakage	$V_{IN} = 0\text{V}$ to V_{CC}		0.1	1.0	μA
$V_{IL1}^{(1)}$ $V_{IH1}^{(1)}$	Input Low Voltage Input High Voltage	$4.5\text{V} \leq V_{CC} \leq 5.5\text{V}$		-0.6 2.0	0.8 $V_{CC} + 1$	V
$V_{IL2}^{(1)}$ $V_{IH2}^{(1)}$	Input Low Voltage Input High Voltage	$1.8\text{V} \leq V_{CC} \leq 2.7\text{V}$		-0.6 $V_{CC} \times 0.7$	$V_{CC} \times 0.3$ $V_{CC} + 1$	V
V_{OL1} V_{OH1}	Output Low Voltage Output High Voltage	$4.5\text{V} \leq V_{CC} \leq 5.5\text{V}$	$I_{OL} = 2.1\text{ mA}$		0.4	V
			$I_{OH} = -0.4\text{ mA}$	2.4		V
V_{OL2} V_{OH2}	Output Low Voltage Output High Voltage	$1.8\text{V} \leq V_{CC} \leq 2.7\text{V}$	$I_{OL} = 0.15\text{ mA}$		0.2	V
			$I_{OH} = -100\text{ }\mu\text{A}$	$V_{CC} - 0.2$		V

Note: 1. V_{IL} min and V_{IH} max are reference only and are not tested.



AC Characteristics

Applicable over recommended operating range from $T_A = -40^{\circ}\text{C}$ to $+85^{\circ}\text{C}$, $V_{CC} = \text{As Specified}$,
 $CL = 1$ TTL Gate and 100 pF (unless otherwise noted).

Symbol	Parameter	Test Condition	Min	Typ	Max	Units
f_{SK}	SK Clock Frequency	$4.5\text{V} \leq V_{CC} \leq 5.5\text{V}$	0		2	MHz
		$2.7\text{V} \leq V_{CC} \leq 5.5\text{V}$	0		1	
		$2.5\text{V} \leq V_{CC} \leq 5.5\text{V}$	0		0.5	
		$1.8\text{V} \leq V_{CC} \leq 5.5\text{V}$	0		0.25	
t_{SKH}	SK High Time	$4.5\text{V} \leq V_{CC} \leq 5.5\text{V}$	250			ns
		$2.7\text{V} \leq V_{CC} \leq 5.5\text{V}$	250			
		$2.5\text{V} \leq V_{CC} \leq 5.5\text{V}$	500			
		$1.8\text{V} \leq V_{CC} \leq 5.5\text{V}$	1000			
t_{SKL}	SK Low Time	$4.5\text{V} \leq V_{CC} \leq 5.5\text{V}$	250			ns
		$2.7\text{V} \leq V_{CC} \leq 5.5\text{V}$	250			
		$2.5\text{V} \leq V_{CC} \leq 5.5\text{V}$	500			
		$1.8\text{V} \leq V_{CC} \leq 5.5\text{V}$	1000			
t_{CS}	Minimum CS Low Time	$4.5\text{V} \leq V_{CC} \leq 5.5\text{V}$	250			ns
		$2.7\text{V} \leq V_{CC} \leq 5.5\text{V}$	250			
		$2.5\text{V} \leq V_{CC} \leq 5.5\text{V}$	500			
		$1.8\text{V} \leq V_{CC} \leq 5.5\text{V}$	1000			
t_{CSS}	CS Setup Time	Relative to SK	$4.5\text{V} \leq V_{CC} \leq 5.5\text{V}$	50		ns
			$2.7\text{V} \leq V_{CC} \leq 5.5\text{V}$	50		
			$2.5\text{V} \leq V_{CC} \leq 5.5\text{V}$	100		
			$1.8\text{V} \leq V_{CC} \leq 5.5\text{V}$	200		
t_{DIS}	DI Setup Time	Relative to SK	$4.5\text{V} \leq V_{CC} \leq 5.5\text{V}$	100		ns
			$2.7\text{V} \leq V_{CC} \leq 5.5\text{V}$	100		
			$2.5\text{V} \leq V_{CC} \leq 5.5\text{V}$	200		
			$1.8\text{V} \leq V_{CC} \leq 5.5\text{V}$	400		
t_{CSH}	CS Hold Time	Relative to SK	0			ns
t_{DIH}	DI Hold Time	Relative to SK	$4.5\text{V} \leq V_{CC} \leq 5.5\text{V}$	100		ns
			$2.7\text{V} \leq V_{CC} \leq 5.5\text{V}$	100		
			$2.5\text{V} \leq V_{CC} \leq 5.5\text{V}$	200		
			$1.8\text{V} \leq V_{CC} \leq 5.5\text{V}$	400		
t_{PD1}	Output Delay to '1'	AC Test	$4.5\text{V} \leq V_{CC} \leq 5.5\text{V}$		250	ns
			$2.7\text{V} \leq V_{CC} \leq 5.5\text{V}$		250	
			$2.5\text{V} \leq V_{CC} \leq 5.5\text{V}$		500	
			$1.8\text{V} \leq V_{CC} \leq 5.5\text{V}$		1000	
t_{PD0}	Output Delay to '0'	AC Test	$4.5\text{V} \leq V_{CC} \leq 5.5\text{V}$		250	ns
			$2.7\text{V} \leq V_{CC} \leq 5.5\text{V}$		250	
			$2.5\text{V} \leq V_{CC} \leq 5.5\text{V}$		500	
			$1.8\text{V} \leq V_{CC} \leq 5.5\text{V}$		1000	
t_{SV}	CS to Status Valid	AC Test	$4.5\text{V} \leq V_{CC} \leq 5.5\text{V}$		250	ns
			$2.7\text{V} \leq V_{CC} \leq 5.5\text{V}$		250	
			$2.5\text{V} \leq V_{CC} \leq 5.5\text{V}$		500	
			$1.8\text{V} \leq V_{CC} \leq 5.5\text{V}$		1000	
t_{DF}	CS to DO in High Impedance	AC Test CS = V_{IL}	$4.5\text{V} \leq V_{CC} \leq 5.5\text{V}$		100	ns
			$2.7\text{V} \leq V_{CC} \leq 5.5\text{V}$		100	
			$2.5\text{V} \leq V_{CC} \leq 5.5\text{V}$		200	
			$1.8\text{V} \leq V_{CC} \leq 5.5\text{V}$		400	
t_{WP}	Write Cycle Time		0.1		10	ms
		$4.5\text{V} \leq V_{CC} \leq 5.5\text{V}$		1		ms
Endurance ⁽¹⁾	5.0V, 25°C, Page Mode		1M			Write Cycles

Note: 1. This parameter is characterized and is not 100% tested.

Instruction Set for the AT93C46

Instruction	SB	Op Code	Address		Data		Comments
			x 8	x 16	x 8	x 16	
READ	1	10	A ₆ - A ₀	A ₅ - A ₀			Reads data stored in memory, at specified address.
EWEN	1	00	11XXXXXX	11XXXX			Write enable must precede all programming modes.
ERASE	1	11	A ₆ - A ₀	A ₅ - A ₀			Erase memory location A _n - A ₀ .
WRITE	1	01	A ₆ - A ₀	A ₅ - A ₀	D ₇ - D ₀	D ₁₅ - D ₀	Writes memory location A _n - A ₀ .
ERAL	1	00	10XXXXXX	10XXXX			Erases all memory locations. Valid only at V _{CC} = 4.5V to 5.5V.
WRAL	1	00	01XXXXXX	01XXXX	D ₇ - D ₀	D ₁₅ - D ₀	Writes all memory locations. Valid only at V _{CC} = 4.5V to 5.5V.
EWDS	1	00	00XXXXXX	00XXXX			Disables all programming instructions.

Instruction Set for the AT93C57

Instruction	SB	Op Code	Address		Data		Comments
			x 8	x 16	x 8	x 16	
READ	1	10	A ₇ - A ₀	A ₆ - A ₀			Reads data stored in memory, at specified address.
EWEN	1	00	11XXXXXXX	11XXXXXX			Write enable must precede all programming modes.
ERASE	1	11	A ₇ - A ₀	A ₆ - A ₀			Erase memory location A _n - A ₀ .
WRITE	1	01	A ₇ - A ₀	A ₆ - A ₀	D ₇ - D ₀	D ₁₅ - D ₀	Writes memory location A _n - A ₀ .
ERAL	1	00	10XXXXXXX	10XXXXXX			Erases all memory locations. Valid only at V _{CC} = 4.5V to 5.5V.
WRAL	1	00	01XXXXXXX	01XXXXXX	D ₇ - D ₀	D ₁₅ - D ₀	Writes all memory locations. Valid only at V _{CC} = 4.5V to 5.5V.
EWDS	1	00	00XXXXXXX	00XXXXXX			Disables all programming instructions.

Instruction Set for the AT93C56 and AT93C66

Instruction	SB	Op Code	Address		Data		Comments
			x 8	x 16	x 8	x 16	
READ	1	10	A ₈ - A ₀	A ₇ - A ₀			Reads data stored in memory, at specified address.
EWEN	1	00	11XXXXXXXX	11XXXXXX			Write enable must precede all programming modes.
ERASE	1	11	A ₈ - A ₀	A ₇ - A ₀			Erases memory location A _n - A ₀ .
WRITE	1	01	A ₈ - A ₀	A ₇ - A ₀	D ₇ - D ₀	D ₁₅ - D ₀	Writes memory location A _n - A ₀ .
ERAL	1	00	10XXXXXXXX	10XXXXXX			Erases all memory locations. Valid only at V _{CC} = 4.5V to 5.5V.
WRAL	1	00	01XXXXXXXX	01XXXXXX	D ₇ - D ₀	D ₁₅ - D ₀	Writes all memory locations. Valid when V _{CC} = 5.0V ± 10% and Disable Register cleared.
EWDS	1	00	00XXXXXXXX	00XXXXXX			Disables all programming instructions.

Functional Description

The AT93C46/56/57/66 is accessed via a simple and versatile 3-wire serial communication interface. Device operation is controlled by seven instructions issued by the host processor. **A valid instruction starts with a rising edge of CS** and consists of a Start Bit (logic “1”) followed by the appropriate Op Code and the desired memory Address location.

READ (READ): The Read (READ) instruction contains the Address code for the memory location to be read. After the instruction and address are decoded, data from the selected memory location is available at the serial output pin DO. Output data changes are synchronized with the rising edges of serial clock SK. It should be noted that a dummy bit (logic “0”) precedes the 8- or 16-bit data output string.

ERASE/WRITE (EWEN): To assure data integrity, the part automatically goes into the Erase/Write Disable (EWDS) state when power is first applied. An Erase/Write Enable (EWEN) instruction must be executed first before any programming instructions can be carried out. Please note that once in the Erase/Write Enable state, programming remains enabled until an Erase/Write Disable (EWDS) instruction is executed or V_{CC} power is removed from the part.

ERASE (ERASE): The Erase (ERASE) instruction programs all bits in the specified memory location to the logical “1” state. The self-timed erase cycle starts once the ERASE instruction and address are decoded. The DO pin outputs the READY/BUSY status of the part if CS is brought high after being kept low for a minimum of 250 ns (t_{CS}). A logic “1” at pin DO indicates that the selected memory location has been erased, and the part is ready for another instruction.

WRITE (WRITE): The Write (WRITE) instruction contains the 8 or 16 bits of data to be written into the specified memory location. The self-timed programming cycle, t_{WP}, starts after the last bit of data is received at serial data input pin DI. The DO pin outputs the READY/BUSY status of the part if CS is brought high after being kept low for a minimum of 250 ns (t_{CS}). A logic “0” at DO indicates that programming is still in progress. A logic “1” indicates that the memory location at the specified address has been written with the data pattern contained in the instruction and the part is ready for further instructions. **A READY/BUSY status cannot be obtained if the CS is brought high after the end of the self-timed programming cycle, t_{WP}.**

ERASE ALL (ERAL): The Erase All (ERAL) instruction programs every bit in the memory array to the logic “1” state and is primarily used for testing purposes. The DO pin outputs the READY/BUSY status of the part if CS is brought high after being kept low for a minimum of 250 ns (t_{CS}). The ERAL instruction is valid only at V_{CC} = 5.0V ± 10%.

WRITE ALL (WRAL): The Write All (WRAL) instruction programs all memory locations with the data patterns specified in the instruction. The DO pin outputs the READY/BUSY status of the part if CS is brought high after being kept low for a minimum of 250 ns (t_{CS}). The WRAL instruction is valid only at V_{CC} = 5.0V ± 10%.

ERASE/WRITE DISABLE (EWDS): To protect against accidental data disturb, the Erase/Write Disable (EWDS) instruction disables all programming modes and should be executed after all programming operations. The operation of the READ instruction is independent of both the EWEN and EWDS instructions and can be executed at any time.

Timing Diagrams

Synchronous Data Timing



Note: 1. This is the minimum SK period.

Organization Key for Timing Diagrams

I/O	AT93C46 (1K)		AT93C56 (2K)		AT93C57 (2K)		AT93C66 (4K)	
	x 8	x 16	x 8	x 16	x 8	x 16	x 8	x 16
A_N	A_6	A_5	$A_8^{(1)}$	$A_7^{(2)}$	A_7	A_6	A_8	A_7
D_N	D_7	D_{15}	D_7	D_{15}	D_7	D_{15}	D_7	D_{15}

Note: 1. A_8 is a DON'T CARE value, but the extra clock is required.

2. A_7 is a DON'T CARE value, but the extra clock is required.

READ Timing



EWEN Timing



EWDS Timing



WRITE Timing



WRAL Timing⁽¹⁾



Note: 1. Valid only at $V_{CC} = 4.5V$ to $5.5V$.

ERASE Timing

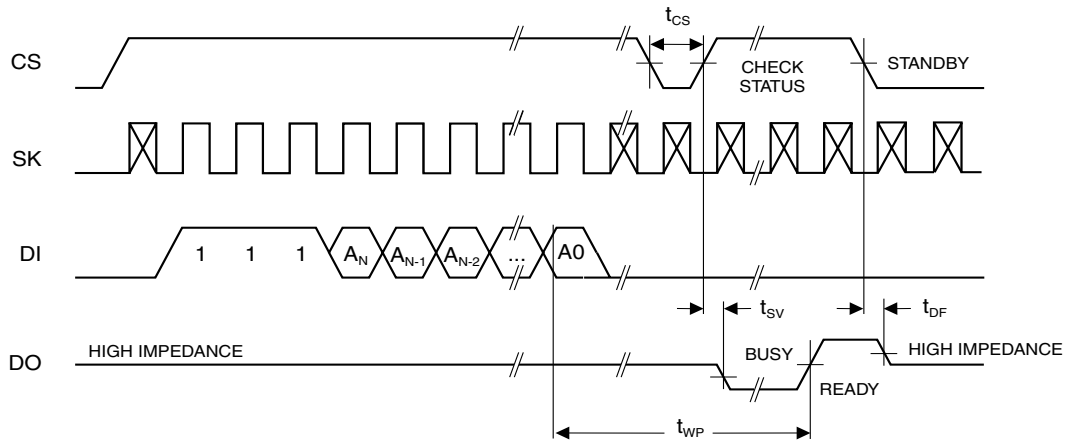

TERAL Timing⁽¹⁾

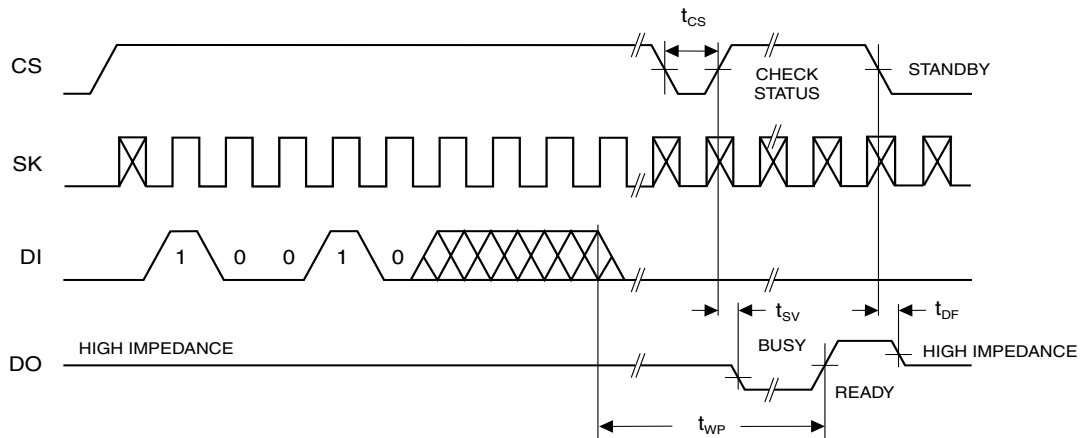

Note: 1. Valid only at $V_{CC} = 4.5V$ to $5.5V$.



AT93C46 Ordering Information

t_{WP} (max) (ms)	I_{CC} (max) (μ A)	I_{SB} (max) (μ A)	f_{MAX} (kHz)	Ordering Code	Package	Operation Range
10	2000	30.0	2000	AT93C46-10PC AT93C46-10SC AT93C46R-10SC AT93C46W-10SC AT93C46-10TC	8P3 8S1 8S1 8S2 8T	Commercial (0°C to 70°C)
		30.0	2000	AT93C46-10PI AT93C46-10SI AT93C46R-10SI AT93C46W-10SI AT93C46-10TI	8P3 8S1 8S1 8S2 8T	Industrial (-40°C to 85°C)
10	800	10.0	1000	AT93C46-10PC-2.7 AT93C46-10SC-2.7 AT93C46R-10SC-2.7 AT93C46W-10SC-2.7 AT93C46-10TC-2.7	8P3 8S1 8S1 8S2 8T	Commercial (0°C to 70°C)
		10.0	1000	AT93C46-10PI-2.7 AT93C46-10SI-2.7 AT93C46R-10SI-2.7 AT93C46W-10SI-2.7 AT93C46-10TI-2.7	8P3 8S1 8S1 8S2 8T	Industrial (-40°C to 85°C)

Package Type	
8P3	8-pin, 0.300" Wide, Plastic Dual Inline Package (PDIP)
8S1	8-lead, 0.150" Wide, Plastic Gull Wing Small Outline (JEDEC SOIC)
8S2	8-lead, 0.200" Wide, Plastic Gull Wing Small Outline (EIAJ SOIC)
8T	8-lead, 0.170" Wide, Thin Shrink Small Outline Package (TSSOP)
Options	
Blank	Standard Operation (4.5V to 5.5V)
-2.7	Low Voltage (2.7V to 5.5V)
-2.5	Low Voltage (2.5V to 5.5V)
R	Rotated Pinout

AT93C46 Ordering Information (Continued)

t_{WP} (max) (ms)	I_{CC} (max) (μA)	I_{SB} (max) (μA)	f_{MAX} (kHz)	Ordering Code	Package	Operation Range
10	600	10.0	500	AT93C46-10PC-2.5 AT93C46-10SC-2.5 AT93C46R-10SC-2.5 AT93C46W-10SC-2.5 AT93C46-10TC-2.5	8P3 8S1 8S1 8S2 8T	Commercial (0°C to 70°C)
		10.0	500	AT93C46-10PI-2.5 AT93C46-10SI-2.5 AT93C46R-10SI-2.5 AT93C46W-10SI-2.5 AT93C46-10TI-2.5	8P3 8S1 8S1 8S2 8T	Industrial (-40°C to 85°C)
10	80	0.1	250	AT93C46-10PC-1.8 AT93C46-10SC-1.8 AT93C46R-10SC-1.8 AT93C46W-10SC-1.8 AT93C46-10TC-1.8	8P3 8S1 8S1 8S2 8T	Commercial (0°C to 70°C)
		0.1	250	AT93C46-10PI-1.8 AT93C46-10SI-1.8 AT93C46R-10SI-1.8 AT93C46W-10SI-1.8 AT93C46-10TI-1.8	8P3 8S1 8S1 8S2 8T	Industrial (-40°C to 85°C)

Package Type	
8P3	8-pin, 0.300" Wide, Plastic Dual Inline Package (PDIP)
8S1	8-lead, 0.150" Wide, Plastic Gull Wing Small Outline (JEDEC SOIC)
8S2	8-lead, 0.200" Wide, Plastic Gull Wing Small Outline (EIAJ SOIC)
8T	8-lead, 0.170" Wide, Thin Shrink Small Outline Package (TSSOP)
Options	
Blank	Standard Operation (4.5V to 5.5V)
-2.7	Low Voltage (2.7V to 5.5V)
-2.5	Low Voltage (2.5V to 5.5V)
-1.8	Low Voltage (1.8V to 5.5V)
R	Rotated Pinout





AT93C56 Ordering Information

t_{WP} (max) (ms)	I_{CC} (max) (μA)	I_{SB} (max) (μA)	f_{MAX} (kHz)	Ordering Code	Package	Operation Range
10	2000	30.0	2000	AT93C56-10PC AT93C56-10SC AT93C56W-10SC	8P3 8S1 8S2	Commercial (0°C to 70°C)
		30.0	2000	AT93C56-10PI AT93C56-10SI AT93C56W-10SI	8P3 8S1 8S2	Industrial (-40°C to 85°C)
10	800	10.0	1000	AT93C56-10PC-2.7 AT93C56-10SC-2.7 AT93C56W-10SC-2.7	8P3 8S1 8S2	Commercial (0°C to 70°C)
		10.0	1000	AT93C56-10PI-2.7 AT93C56-10SI-2.7 AT93C56W-10SI-2.7	8P3 8S1 8S2	Industrial (-40°C to 85°C)
10	600	10.0	500	AT93C56-10PC-2.5 AT93C56-10SC-2.5 AT93C56W-10SC-2.5	8P3 8S1 8S2	Commercial (0°C to 70°C)
		10.0	500	AT93C56-10PI-2.5 AT93C56-10SI-2.5 AT93C56W-10SI-2.5	8P3 8S1 8S2	Industrial (-40°C to 85°C)

Package Type	
8P3	8-pin, 0.300" Wide, Plastic Dual Inline Package (PDIP)
8S1	8-lead, 0.150" Wide, Plastic Gull Wing Small Outline (JEDEC SOIC)
8S2	8-lead, 0.200" Wide, Plastic Gull Wing Small Outline (EIAJ SOIC)
Options	
Blank	Standard Operation (4.5V to 5.5V)
-2.7	Low Voltage (2.7V to 5.5V)
-2.5	Low Voltage (2.5V to 5.5V)

AT93C57 Ordering Information

t_{WP} (max) (ms)	I_{CC} (max) (μA)	I_{SB} (max) (μA)	f_{MAX} (kHz)	Ordering Code	Package	Operation Range
10	2000	30.0	2000	AT93C57-10PC AT93C57-10SC AT93C57W-10SC	8P3 8S1 8S2	Commercial (0°C to 70°C)
		30.0	2000	AT93C57-10PI AT93C57-10SI AT93C57W-10SI	8P3 8S1 8S2	Industrial (-40°C to 85°C)
10	800	10.0	1000	AT93C57-10PC-2.7 AT93C57-10SC-2.7 AT93C57W-10SC-2.7	8P3 8S1 8S2	Commercial (0°C to 70°C)
		10.0	1000	AT93C57-10PI-2.7 AT93C57-10SI-2.7 AT93C57W-10SI-2.7	8P3 8S1 8S2	Industrial (-40°C to 85°C)

Package Type	
8P3	8-pin, 0.300" Wide, Plastic Dual Inline Package (PDIP)
8S1	8-lead, 0.150" Wide, Plastic Gull Wing Small Outline (JEDEC SOIC)
8S2	8-lead, 0.200" Wide, Plastic Gull Wing Small Outline (EIAJ SOIC)
Options	
Blank	Standard Operation (4.5V to 5.5V)
-2.7	Low Voltage (2.7V to 5.5V)
-2.5	Low Voltage (2.5V to 5.5V)





AT93C66 Ordering Information

t_{WP} (max) (ms)	I_{CC} (max) (μA)	I_{SB} (max) (μA)	f_{MAX} (kHz)	Ordering Code	Package	Operation Range
10	2000	30.0	2000	AT93C66-10PC AT93C66-10SC AT93C66W-10SC AT93C66-10TC	8P3 8S1 8S2 8T	Commercial (0°C to 70°C)
		30.0	2000	AT93C66-10PI AT93C66-10SI AT93C66W-10SI AT93C66-10TI	8P3 8S1 8S2 8T	Industrial (-40°C to 85°C)
10	800	10.0	1000	AT93C66-10PC-2.7 AT93C66-10SC-2.7 AT93C66W-10SC-2.7 AT93C66-10TC-2.7	8P3 8S1 8S2 8T	Commercial (0°C to 70°C)
		10.0	1000	AT93C66-10PI-2.7 AT93C66-10SI-2.7 AT93C66W-10SI-2.7 AT93C66-10TI-2.7	8P3 8S1 8S2 8T	Industrial (-40°C to 85°C)
10	600	10.0	500	AT93C66-10PC-2.5 AT93C66-10SC-2.5 AT93C66W-10SC-2.5 AT93C66-10TC-2.5	8P3 8S1 8S2 8T	Commercial (0°C to 70°C)
		10.0	500	AT93C66-10PI-2.5 AT93C66-10SI-2.5 AT93C66W-10SI-2.5 AT93C66-10TI-2.5	8P3 8S1 8S2 8T	Industrial (-40°C to 85°C)

Package Type	
8P3	8-pin, 0.300" Wide, Plastic Dual Inline Package (PDIP)
8S1	8-lead, 0.150" Wide, Plastic Gull Wing Small Outline (JEDEC SOIC)
8S2	8-lead, 0.200" Wide, Plastic Gull Wing Small Outline (EIAJ SOIC)
8T	8-lead, 0.170" Wide, Thin Shrink Small Outline Package (TSSOP)
Options	
Blank	Standard Operation (4.5V to 5.5V)
-2.7	Low Voltage (2.7V to 5.5V)
-2.5	Low Voltage (2.5V to 5.5V)

Packaging Information

8P3, 8-pin, 0.300" Wide,
Plastic Dual Inline Package (PDIP)
Dimensions in Inches and (Millimeters)
JEDEC STANDARD MS-001 BA



8S1, 8-lead, 0.150" Wide,
Plastic Gull Wing Small Outline (JEDEC SOIC)
Dimensions in Inches and (Millimeters)



8S2, 8-lead, 0.200" Wide,
Plastic Gull Wing Small Outline (EIAJ SOIC)
Dimensions in Inches and (Millimeters)

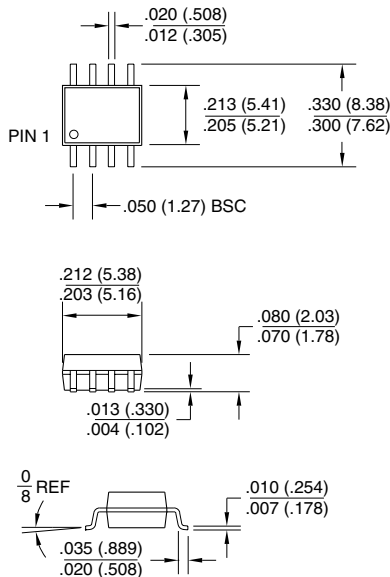

8T, 8-lead, 0.170" Wide,
Thin Shrink Small Outline Package (TSSOP)
Dimensions in Millimeters and (Inches)*



*Controlling dimension: millimeters



Atmel Headquarters

Corporate Headquarters

2325 Orchard Parkway
San Jose, CA 95131
TEL (408) 441-0311
FAX (408) 487-2600

Europe

Atmel U.K., Ltd.
Coliseum Business Centre
Riverside Way
Camberley, Surrey GU15 3YL
England
TEL (44) 1276-686-677
FAX (44) 1276-686-697

Asia

Atmel Asia, Ltd.
Room 1219
Chinachem Golden Plaza
77 Mody Road Tsimhatsui
East Kowloon
Hong Kong
TEL (852) 2721-9778
FAX (852) 2722-1369

Japan

Atmel Japan K.K.
9F, Tonetsu Shinkawa Bldg.
1-24-8 Shinkawa
Chuo-ku, Tokyo 104-0033
Japan
TEL (81) 3-3523-3551
FAX (81) 3-3523-7581

Atmel Operations

Atmel Colorado Springs

1150 E. Cheyenne Mtn. Blvd.
Colorado Springs, CO 80906
TEL (719) 576-3300
FAX (719) 540-1759

Atmel Rousset

Zone Industrielle
13106 Rousset Cedex
France
TEL (33) 4-4253-6000
FAX (33) 4-4253-6001

Fax-on-Demand

North America:
1-(800) 292-8635
International:
1-(408) 441-0732

e-mail

literature@atmel.com

Web Site

<http://www.atmel.com>

BBS

1-(408) 436-4309

© Atmel Corporation 1999.

Atmel Corporation makes no warranty for the use of its products, other than those expressly contained in the Company's standard warranty which is detailed in Atmel's Terms and Conditions located on the Company's web site. The Company assumes no responsibility for any errors which may appear in this document, reserves the right to change devices or specifications detailed herein at any time without notice, and does not make any commitment to update the information contained herein. No licenses to patents or other intellectual property of Atmel are granted by the Company in connection with the sale of Atmel products, expressly or by implication. Atmel's products are not authorized for use as critical components in life support devices or systems.

Marks bearing ® and/or ™ are registered trademarks and trademarks of Atmel Corporation.

Terms and product names in this document may be trademarks of others.



Printed on recycled paper.

0172L-10/99/xM

Looking for pricing, stock, or lifecycle information?

Click below to explore more details on WIN SOURCE:

- ⊖ [View AT93C56-10SI on WIN SOURCE](#)
- ⊖ [Microchip Technology Information](#)

Optimize Your Supply Chain with WIN SOURCE Solutions

- ✓ Global Sourcing Solution
- ✓ Obsolete Management
- ✓ Cost Control Management
- ✓ Shortage Management
- ✓ Alternative Solution
- ✓ Excess Inventory Management