



**THE DATASHEET OF  
MAX5864ETM+**



EVALUATION KIT  
AVAILABLE**MAXIM**

# Ultra-Low-Power, High-Dynamic-Performance, 22MSPS Analog Front End

## General Description

The MAX5864 ultra-low-power, highly integrated analog front end is ideal for portable communication equipment such as handsets, PDAs, WLAN, and 3G wireless terminals. The MAX5864 integrates dual 8-bit receive ADCs and dual 10-bit transmit DACs while providing the highest dynamic performance at ultra-low power. The ADCs' analog I-Q input amplifiers are fully differential and accept 1V<sub>p-p</sub> full-scale signals. Typical I-Q channel phase matching is  $\pm 0.1^\circ$  and amplitude matching is  $\pm 0.03\text{dB}$ . The ADCs feature 48.5dB SINAD and 69dBc spurious-free dynamic range (SFDR) at  $f_{IN} = 5.5\text{MHz}$  and  $f_{CLK} = 22\text{MSPS}$ . The DACs' analog I-Q outputs are fully differential with  $\pm 400\text{mV}$  full-scale output, and 1.4V common-mode level. Typical I-Q channel phase match is  $\pm 0.15^\circ$  and amplitude match is  $\pm 0.05\text{dB}$ . The DACs also feature dual 10-bit resolution with 71.7dBc SFDR, and 57dB SNR at  $f_{OUT} = 2.2\text{MHz}$  and  $f_{CLK} = 22\text{MHz}$ .

The ADCs and DACs operate simultaneously or independently for frequency-division duplex (FDD) and time-division duplex (TDD) modes. A 3-wire serial interface controls power-down and transceiver modes of operation. The typical operating power is 42mW at  $f_{CLK} = 22\text{MSPS}$  with the ADCs and DACs operating simultaneously in transceiver mode. The MAX5864 features an internal 1.024V voltage reference that is stable over the entire operating power-supply range and temperature range. The MAX5864 operates on a +2.7V to +3.3V analog power supply and a +1.8V to +3.3V digital I/O power supply for logic compatibility. The quiescent current is 5.6mA in idle mode and 1 $\mu\text{A}$  in shutdown mode. The MAX5864 is specified for the extended ( $-40^\circ\text{C}$  to  $+85^\circ\text{C}$ ) temperature range and is available in a 48-pin thin QFN package.

## Applications

Narrowband/Wideband CDMA Handsets and PDAs  
Fixed/Mobile Broadband Wireless Modems  
3G Wireless Terminals

## Ordering Information

PART	TEMP RANGE	PIN-PACKAGE
MAX5864ETM	-40°C to +85°C	48 Thin QFN-EP* (7mm x 7mm)
MAX5864E/D	-40°C to +85°C	Dice**

\*EP = Exposed paddle.

\*\*Contact factory for dice specifications.

Pin Configuration appears at end of data sheet.

## Features

- ◆ Integrated Dual 8-Bit ADCs and Dual 10-Bit DACs
- ◆ Ultra-Low Power
  - 42mW at  $f_{CLK} = 22\text{MHz}$  (Transceiver Mode)
  - 34mW at  $f_{CLK} = 15.36\text{MHz}$  (Transceiver Mode)
  - Low-Current Idle and Shutdown Modes
- ◆ Excellent Dynamic Performance
  - 48.5dB SINAD at  $f_{IN} = 5.5\text{MHz}$  (ADC)
  - 71.7dB SFDR at  $f_{OUT} = 2.2\text{MHz}$  (DAC)
- ◆ Excellent Gain/Phase Match
  - $\pm 0.1^\circ$  Phase,  $\pm 0.03\text{dB}$  Gain at  $f_{IN} = 5.5\text{MHz}$  (ADC)
- ◆ Internal/External Reference Option
- ◆ +1.8V to +3.3V Digital Output Level (TTL/CMOS Compatible)
- ◆ Multiplexed Parallel Digital Input/Output for ADCs/DACs
- ◆ Miniature 48-Pin Thin QFN Package (7mm x 7mm)
- ◆ Evaluation Kit Available (Order MAX5865EVKIT)

MAX5864

## Functional Diagram

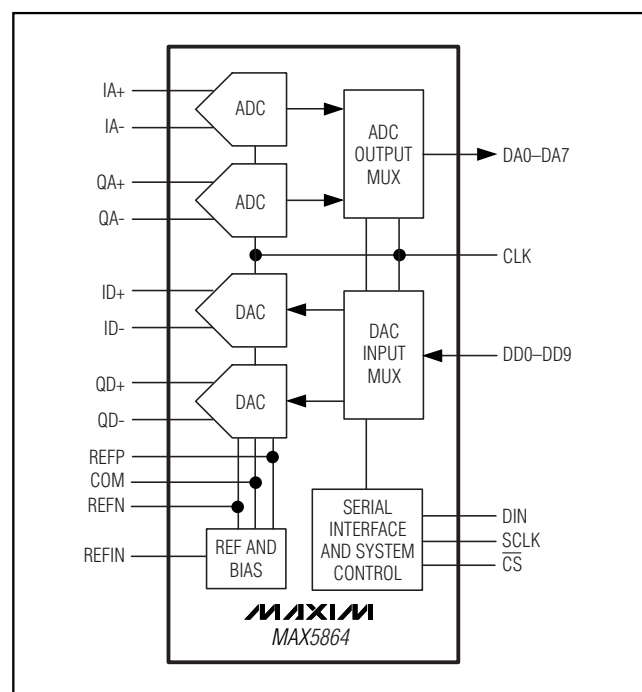
**MAXIM**

Maxim Integrated Products 1

For pricing, delivery, and ordering information, please contact Maxim/Dallas Direct! at 1-888-629-4642, or visit Maxim's website at [www.maxim-ic.com](http://www.maxim-ic.com).

# Ultra-Low-Power, High Dynamic-Performance, 22Msps Analog Front End

## ABSOLUTE MAXIMUM RATINGS

V<sub>DD</sub> to GND, OV<sub>DD</sub> to OGND.....-0.3V to +3.3V  
 GND to OGND.....-0.3V to +0.3V  
 IA+, IA-, QA+, QA-, ID+, ID-, QD+, QD-, REFP, REFN,  
 REFIN, COM to GND.....-0.3V to (V<sub>DD</sub> + 0.3V)  
 DD0–DD9, SCLK, DIN,  $\overline{CS}$ , CLK,  
 DA0–DA7 to OGND .....-0.3V to (OV<sub>DD</sub> + 0.3V)

Continuous Power Dissipation (T<sub>A</sub> = +70°C)  
 48-Pin Thin QFN (derate 26.3mW/°C above +70°C) .....2.1W  
 Thermal Resistance  $\theta_{JA}$ .....+38°C/W  
 Operating Temperature Range .....-40°C to +85°C  
 Junction Temperature.....+150°C  
 Storage Temperature Range .....-60°C to +150°C  
 Lead Temperature (soldering, 10s) .....+300°C

Stresses beyond those listed under "Absolute Maximum Ratings" may cause permanent damage to the device. These are stress ratings only, and functional operation of the device at these or any other conditions beyond those indicated in the operational sections of the specifications is not implied. Exposure to absolute maximum rating conditions for extended periods may affect device reliability.

## ELECTRICAL CHARACTERISTICS

(V<sub>DD</sub> = 3V, OV<sub>DD</sub> = 1.8V, internal reference (1.024V), C<sub>L</sub> ≈ 10pF on all digital outputs, f<sub>CLK</sub> = 22MHz, ADC input amplitude = -0.5dBFS, DAC output amplitude = 0dBFS, differential ADC input, differential DAC output, C<sub>REFP</sub> = C<sub>REFN</sub> = C<sub>COM</sub> = 0.33μF, Xcvr mode, unless otherwise noted. Typical values are at T<sub>A</sub> = +25°C, unless otherwise noted.) (Note 1)

PARAMETER	SYMBOL	CONDITIONS	MIN	TYP	MAX	UNITS
<b>POWER REQUIREMENTS</b>						
Analog Supply Voltage	V <sub>DD</sub>		2.7	3.0	3.3	V
Output Supply Voltage	OV <sub>DD</sub>		1.8		V <sub>DD</sub>	V
V <sub>DD</sub> Supply Current		ADC operating mode, f <sub>IN</sub> = 5.5MHz, f <sub>CLK</sub> = 22MHz, DAC operating mode, f <sub>OUT</sub> = 2.2MHz		14	16.5	mA
		ADC operating mode, f <sub>IN</sub> = 5.5MHz, f <sub>CLK</sub> = 15.36MHz, DAC operating mode, f <sub>OUT</sub> = 2.2MHz		11.4		
		ADC operating mode (Rx), f <sub>IN</sub> = 5.5MHz, f <sub>CLK</sub> = 15.36MHz, DAC off, DAC digital inputs at zero or DV <sub>DD</sub>		8.25		
		DAC operating mode (Tx), f <sub>OUT</sub> = 2.2MHz, f <sub>CLK</sub> = 15.36MHz, ADC off		8		
		Standby mode, DAC digital inputs and CLK at zero or OV <sub>DD</sub>		2.0		
		Idle mode, DAC digital inputs at zero or OV <sub>DD</sub> , f <sub>CLK</sub> = 22MHz		6.7		
		Shutdown mode, digital inputs and CLK at zero or OV <sub>DD</sub> , $\overline{CS}$ = OV <sub>DD</sub>		1	μA	
OV <sub>DD</sub> Supply Current		ADC operating mode, f <sub>IN</sub> = 5.5MHz, f <sub>CLK</sub> = 22MHz, DAC operating mode, f <sub>OUT</sub> = 2.2MHz		2.3		mA
		Idle mode, DAC digital inputs at zero or OV <sub>DD</sub> , f <sub>CLK</sub> = 22MHz		20.6	μA	
		Shutdown mode, DAC digital inputs and CLK at zero or OV <sub>DD</sub> , $\overline{CS}$ = OV <sub>DD</sub>		1		

# Ultra-Low-Power, High Dynamic-Performance, 22MSPS Analog Front End

MAX5864

## ELECTRICAL CHARACTERISTICS (continued)

( $V_{DD} = 3V$ ,  $OV_{DD} = 1.8V$ , internal reference (1.024V),  $C_L \approx 10pF$  on all digital outputs,  $f_{CLK} = 22MHz$ , ADC input amplitude = -0.5dBFS, DAC output amplitude = 0dBFS, differential ADC input, differential DAC output,  $C_{REFP} = C_{REFN} = C_{COM} = 0.33\mu F$ , Xcvr mode, unless otherwise noted. Typical values are at  $T_A = +25^\circ C$ , unless otherwise noted.) (Note 1)

PARAMETER	SYMBOL	CONDITIONS	MIN	TYP	MAX	UNITS
<b>ADC DC ACCURACY</b>						
Resolution			8			Bits
Integral Nonlinearity	INL			$\pm 0.15$		LSB
Differential Nonlinearity	DNL	No missing codes over temperature		$\pm 0.15$		LSB
Offset Error		Residual DC offset error		$\pm 0.24$	$\pm 5$	%FS
Gain Error		Includes reference error		$\pm 0.77$	$\pm 5$	%FS
DC Gain Matching				$\pm 0.03$	$\pm 0.25$	dB
Offset Matching				$\pm 3$		LSB
Gain Temperature Coefficient				$\pm 59$		ppm/ $^\circ C$
Power-Supply Rejection	PSRR	Offset error ( $V_{DD} \pm 5\%$ )		$\pm 0.2$		LSB
		Gain error ( $V_{DD} \pm 5\%$ )		$\pm 0.07$		
<b>ADC ANALOG INPUT</b>						
Input Differential Range	$V_{ID}$	Differential or single-ended inputs		$\pm 0.512$		V
Input Common-Mode Voltage Range				$V_{DD} / 2$		V
Input Impedance	$R_{IN}$	Switched capacitor load		245		k $\Omega$
	$C_{IN}$			5		pF
<b>ADC CONVERSION RATE</b>						
Maximum Clock Frequency	$f_{CLK}$	(Note 2)			22	MHz
Data Latency		Channel I		5		Clock cycles
		Channel Q		5.5		
<b>ADC DYNAMIC CHARACTERISTICS (Note 3)</b>						
Signal-to-Noise Ratio	SNR	$f_{IN} = 5.5MHz$	47	48.6		dB
		$f_{IN} = 11MHz$		48.6		
Signal-to-Noise and Distortion Ratio	SINAD	$f_{IN} = 5.5MHz$	46.5	48.5		dB
		$f_{IN} = 11MHz$		48.5		
Spurious-Free Dynamic Range	SFDR	$f_{IN} = 5.5MHz$	58	69		dBc
		$f_{IN} = 11MHz$		71.5		
Third-Harmonic Distortion	HD3	$f_{IN} = 5.5MHz$		-70.3		dBc
		$f_{IN} = 11MHz$		-75.5		
Intermodulation Distortion	IMD	$f_1 = 2MHz, -7dBFS; f_2 = 2.01MHz, -7dBFS$		-64		dBc
Third-Order Intermodulation Distortion	IM3	$f_1 = 2MHz, -7dBFS; f_2 = 2.01MHz, -7dBFS$		-67		dBc
Total Harmonic Distortion	THD	$f_{IN} = 5.5MHz$		-68.2	-57	dBc
		$f_{IN} = 11MHz$		-68		

# Ultra-Low-Power, High Dynamic-Performance, 22Msps Analog Front End

## ELECTRICAL CHARACTERISTICS (continued)

( $V_{DD} = 3V$ ,  $OV_{DD} = 1.8V$ , internal reference (1.024V),  $C_L \approx 10pF$  on all digital outputs,  $f_{CLK} = 22MHz$ , ADC input amplitude = -0.5dBFS, DAC output amplitude = 0dBFS, differential ADC input, differential DAC output,  $C_{REFP} = C_{REFN} = C_{COM} = 0.33\mu F$ , Xcvr mode, unless otherwise noted. Typical values are at  $T_A = +25^\circ C$ , unless otherwise noted.) (Note 1)

PARAMETER	SYMBOL	CONDITIONS	MIN	TYP	MAX	UNITS
Small-Signal Bandwidth	SSBW	$A_{IN} = -20dBFS$		440		MHz
Large-Signal Bandwidth	FBW	$A_{IN} = -0.5dBFS$		440		MHz
Aperture Delay				3.3		ns
Aperture Jitter				2.7		psRMS
Overdrive Recovery Time		1.5 × full-scale input		2		ns
<b>ADC INTERCHANNEL CHARACTERISTICS</b>						
Crosstalk Rejection		$f_{INX} = 5.5MHz$ at -0.5dBFS, $f_{INY} = 0.3MHz$ at -0.5dBFS (Note 5)		-75		dB
Amplitude Matching		$f_{IN} = 5.5MHz$ at -0.5dBFS (Note 6)		$\pm 0.03$		dB
Phase Matching		$f_{IN} = 5.5MHz$ at -0.5dBFS (Note 6)		$\pm 0.1$		Degrees
<b>DAC DC ACCURACY</b>						
Resolution	N		10			Bits
Integral Nonlinearity	INL			$\pm 1$		LSB
Differential Nonlinearity	DNL	Guaranteed monotonic		$\pm 0.5$		LSB
Zero-Scale Error		Residual DC offset		$\pm 3$		LSB
Full-Scale Error		Include Reference Error	-35		+35	LSB
<b>DAC DYNAMIC PERFORMANCE</b>						
DAC Conversion Rate		(Note 2)			22	MspS
Noise over Nyquist	$N_D$	$f_{OUT} = 2.2MHz$ , $f_{CLK} = 22MHz$		-128.4		dBc/Hz
Output-of-Band Noise Power Density	$N_O$	$f_{OUT} = 1.2MHz$ , $f_{CLK} = 15.36MHz$ , offset = 10MHz		-131.5		dBc/Hz
Adjacent Channel Power Ratio	ACPR	WCDMA at offset = 5MHz, $f_{CLK} = 15.36MspS$		57		dB
Glitch Impulse				10		pVs
Spurious-Free Dynamic Range	SFDR	$f_{CLK} = 22MHz$	$f_{OUT} = 2.2MHz$	60	71.7	dBc
		$f_{CLK} = 15.36MHz$	$f_{OUT} = 200kHz$		72.5	
Total Harmonic Distortion (to Nyquist)	THD	$f_{CLK} = 22MHz$ , $f_{OUT} = 2.2MHz$		-70	-59	dB
Signal-to-Noise Ratio (to Nyquist)	SNR	$f_{CLK} = 22MHz$ , $f_{OUT} = 2.2MHz$		57		dB
<b>DAC INTERCHANNEL CHARACTERISTICS</b>						
DAC-to-DAC Output Isolation		$f_{OUTX, Y} = 2.2MHz$ , $f_{OUTX, Y} = 2.0MHz$		80		dB
Gain Mismatch Between DAC Outputs		$f_{OUT} = 2.2MHz$ , $f_{CLK} = 22MHz$		$\pm 0.05$		dB
Phase Mismatch Between DAC Outputs		$f_{OUT} = 2.2MHz$ , $f_{CLK} = 22MHz$		$\pm 0.15$		Degrees

# Ultra-Low-Power, High Dynamic-Performance, 22Msps Analog Front End

MAX5864

## ELECTRICAL CHARACTERISTICS (continued)

( $V_{DD} = 3V$ ,  $OV_{DD} = 1.8V$ , internal reference (1.024V),  $C_L \approx 10pF$  on all digital outputs,  $f_{CLK} = 22MHz$ , ADC input amplitude = -0.5dBFS, DAC output amplitude = 0dBFS, differential ADC input, differential DAC output,  $C_{REFF} = C_{REFN} = C_{COM} = 0.33\mu F$ , Xcvr mode, unless otherwise noted. Typical values are at  $T_A = +25^\circ C$ , unless otherwise noted.) (Note 1)

PARAMETER	SYMBOL	CONDITIONS	MIN	TYP	MAX	UNITS
<b>DAC ANALOG OUTPUT</b>						
Full-Scale Output Voltage	$V_{FS}$			±400		mV
Output Common-Mode Range			1.29		1.5	V
<b>ADC-DAC INTERCHANNEL CHARACTERISTICS</b>						
ADC-DAC Isolation		ADC $f_{IN1} = f_{INQ} = 5.5MHz$ , DAC $f_{OUT1} = f_{OUTQ} = 2.2MHz$ , $f_{CLK} = 22MHz$		75		dB
<b>ADC-DAC TIMING CHARACTERISTICS</b>						
CLK Rise to I-ADC Channel-I Output Data Valid	$t_{DOI}$	Figure 3 (Note 4)		7.4	9	ns
CLK Fall to Q-ADC Channel-Q Output Data Valid	$t_{DOQ}$	Figure 3 (Note 4)		6.9	9	ns
I-DAC Data to CLK Fall Setup Time	$t_{DSI}$	Figure 4 (Note 4)	10			ns
Q-DAC Data to CLK Rise Setup Time	$t_{DSQ}$	Figure 4 (Note 4)	10			ns
CLK Fall to I-DAC Data Hold Time	$t_{DHI}$	Figure 4 (Note 4)	0			ns
CLK Rise to Q-DAC Data Hold Time	$t_{DHQ}$	Figure 4 (Note 4)	0			ns
Clock Duty Cycle				50		%
CLK Duty-Cycle Variation				±15		%
Digital Output Rise/Fall Time		20% to 80%		2.6		ns
<b>SERIAL INTERFACE TIMING CHARACTERISTICS</b>						
Falling Edge of $\overline{CS}$ to Rising Edge of First SCLK Time	$t_{CSS}$	Figure 5 (Note 4)	10			ns
DIN to SCLK Setup Time	$t_{DS}$	Figure 5 (Note 4)	10			ns
DIN to SCLK Hold Time	$t_{DH}$	Figure 5 (Note 4)	0			ns
SCLK Pulse Width High	$t_{CH}$	Figure 5 (Note 4)	25			ns
SCLK Pulse Width Low	$t_{CL}$	Figure 5 (Note 4)	25			ns
SCLK Period	$t_{CP}$	Figure 5 (Note 4)	50			ns
SCLK to $\overline{CS}$ Setup Time	$t_{CS}$	Figure 5 (Note 4)	0			ns
$\overline{CS}$ High Pulse Width	$t_{CSW}$	Figure 5 (Note 4)	80			ns
<b>MODE RECOVERY TIMING CHARACTERISTICS</b>						
Shutdown Wake-Up Time	$t_{WAKE,SD}$	From shutdown to Rx mode, Figure 6, ADC settles to within 1dB		20		$\mu s$
		From shutdown to Tx mode, Figure 6, DAC settles to within 1 LSB error		40		

# Ultra-Low-Power, High Dynamic-Performance, 22MSPS Analog Front End

## ELECTRICAL CHARACTERISTICS (continued)

( $V_{DD} = 3V$ ,  $OV_{DD} = 1.8V$ , internal reference (1.024V),  $C_L \approx 10pF$  on all digital outputs,  $f_{CLK} = 22MHz$ , ADC input amplitude = -0.5dBFS, DAC output amplitude = 0dBFS, differential ADC input, differential DAC output,  $C_{REFP} = C_{REFN} = C_{COM} = 0.33\mu F$ , Xcvr mode, unless otherwise noted. Typical values are at  $T_A = +25^\circ C$ , unless otherwise noted.) (Note 1)

PARAMETER	SYMBOL	CONDITIONS	MIN	TYP	MAX	UNITS
Idle Wake-Up Time (with CLK)	$t_{WAKE,ST}$	From idle to Rx mode with CLK present during idle, Figure 6, ADC settles to within 1dB SINAD		10		$\mu s$
		From idle to Tx mode with CLK present during idle, Figure 6, DAC settles to 10 LSB error		10		
Standby Wake-Up Time	$t_{WAKE,S1}$	From standby to Rx mode, Figure 6, ADC settles to within 1dB SINAD		10		$\mu s$
		From standby to Tx mode, Figure 6, DAC settles to 10 LSB error		40		
Enable Time from Xcvr or Tx to Rx	$t_{ENABLE,Rx}$	ADC settles to within 1dB SINAD		10		$\mu s$
Enable Time from Xcvr or Rx to Tx	$t_{ENABLE,Tx}$	DAC settles to 1 LSB error		10		$\mu s$
<b>INTERNAL REFERENCE</b> ( $REFIN = V_{DD}$ . $V_{REFP}$ , $V_{REFN}$ , and $V_{COM}$ are generated internally)						
Positive Reference		$V_{REFP} - V_{COM}$		0.256		V
Negative Reference		$V_{REFN} - V_{COM}$		-0.256		V
Common-Mode Output Voltage	$V_{COM}$		$V_{DD}/2 - 0.15$	$V_{DD}/2$	$V_{DD}/2 + 0.15$	V
Differential Reference Output	$V_{REF}$	$V_{REFP} - V_{REFN}$	+0.49	+0.512	+0.534	V
Differential Reference Temperature Coefficient	REFTC			$\pm 30$		ppm/ $^\circ C$
Maximum REFP/REFN/COM Source Current	$I_{SOURCE}$			2		mA
Maximum REFP/REFN/COM Sink Current	$I_{SINK}$			2		mA
<b>BUFFERED EXTERNAL REFERENCE</b> ( $REFIN = 1.024V$ . $V_{REFP}$ , $V_{REFN}$ , and $V_{COM}$ are generated internally)						
Reference Input	$V_{REFIN}$			1.024		V
Differential Reference Output	$V_{DIFF}$	$V_{REFP} - V_{REFN}$		0.512		V
Common-Mode Output Voltage	$V_{COM}$			$V_{DD}/2$		V
Maximum REFP/REFN/COM Source Current	$I_{SOURCE}$			2		mA
Maximum REFP/REFN/COM Sink Current	$I_{SINK}$			2		mA
REFIN Input Resistance				>500		$k\Omega$
REFIN Input Current				-0.7		$\mu A$
<b>DIGITAL INPUTS (CLK, SCLK, DIN, <math>\overline{CS}</math>, DD0-DD9)</b>						
Input High Threshold	$V_{INH}$	DD0-DD9, CLK, SCLK, DIN, $\overline{CS}$		0.7 x $OV_{DD}$		V

# Ultra-Low-Power, High Dynamic-Performance, 22MSPS Analog Front End

MAX5864

## ELECTRICAL CHARACTERISTICS (continued)

( $V_{DD} = 3V$ ,  $OV_{DD} = 1.8V$ , internal reference (1.024V),  $C_L \approx 10pF$  on all digital outputs,  $f_{CLK} = 22MHz$ , ADC input amplitude = -0.5dBFS, DAC output amplitude = 0dBFS, differential ADC input, differential DAC output,  $C_{REFP} = C_{REFN} = C_{COM} = 0.33\mu F$ , Xcvr mode, unless otherwise noted. Typical values are at  $T_A = +25^\circ C$ , unless otherwise noted.) (Note 1)

PARAMETER	SYMBOL	CONDITIONS	MIN	TYP	MAX	UNITS
Input Low Threshold	$V_{INL}$	DD0–DD9, CLK, SCLK, DIN, $\overline{CS}$			$0.3 \times OV_{DD}$	V
Input Leakage	$I_{IN}$	DD0–DD9, CLK, SCLK, DIN, $\overline{CS} = OGND$ or $OV_{DD}$			$\pm 5$	$\mu A$
Input Capacitance	$DC_{IN}$			5		pF
<b>DIGITAL OUTPUTS (DA0–DA7)</b>						
Output Voltage Low	$V_{OL}$	$I_{SINK} = 200\mu A$			$0.2 \times OV_{DD}$	V
Output Voltage High	$V_{OH}$	$I_{SOURCE} = 200\mu A$	$0.8 \times OV_{DD}$			V
Tri-State Leakage Current	$I_{LEAK}$				$\pm 5$	$\mu A$
Tri-State Output Capacitance	$C_{OUT}$			5		pF

**Note 1:** Specifications from  $T_A = +25^\circ C$  to  $+85^\circ C$  are guaranteed by product tests. Specifications from  $T_A = +25^\circ C$  to  $-40^\circ C$  are guaranteed by design and characterization.

**Note 2:** The minimum clock frequency for the MAX5864 is 7.5MHz.

**Note 3:** SNR, SINAD, SFDR, HD3, and THD are based on a differential analog input voltage of -0.5dBFS referenced to the amplitude of the digital outputs. SINAD and THD are calculated using HD2 through HD6.

**Note 4:** Guaranteed by design and characterization.

**Note 5:** Crosstalk rejection is measured by applying a high-frequency test tone to one channel and a low-frequency tone to the second channel. FFTs are performed on each channel. The parameter is specified as the power ratio of the first and second channel FFT test tone bins.

**Note 6:** Amplitude/phase matching is measured by applying the same signal to each channel, and comparing the magnitude and phase of the fundamental bin on the calculated FFT.

## Typical Operating Characteristics

( $V_{DD} = DV_{DD} = 3V$ ,  $OV_{DD} = 1.8V$ , internal reference (1.024V),  $C_L \approx 10pF$  on all digital outputs,  $f_{CLK} = 22MHz$  50% duty cycle, ADC input amplitude = -0.5dBFS, DAC output amplitude = 0dBFS, differential ADC input, differential DAC output,  $C_{REFP} = C_{REFN} = C_{COM} = 0.33\mu F$ , Xcvr mode,  $T_A = +25^\circ C$ , unless otherwise noted.)

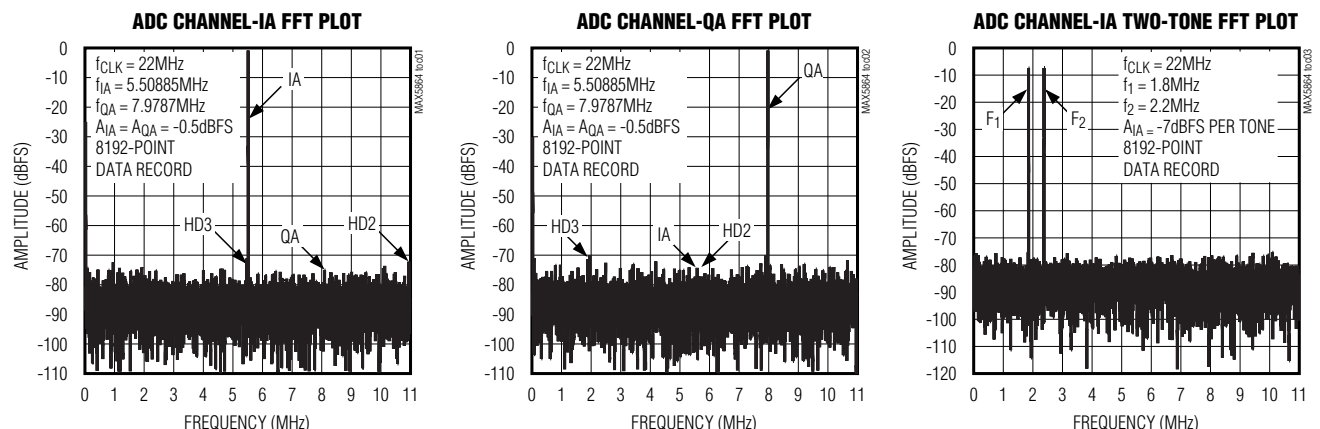

# Ultra-Low-Power, High Dynamic-Performance, 22MSPS Analog Front End

## Typical Operating Characteristics (continued)

( $V_{DD} = DV_{DD} = 3V$ ,  $OV_{DD} = 1.8V$ , internal reference (1.024V),  $C_L \approx 10pF$  on all digital outputs,  $f_{CLK} = 22MHz$  50% duty cycle, ADC input amplitude = -0.5dBFS, DAC output amplitude = 0dBFS, differential ADC input, differential DAC output,  $C_{REFP} = C_{REFN} = C_{COM} = 0.33\mu F$ , Xcvr mode,  $T_A = +25^\circ C$ , unless otherwise noted.)

ADC CHANNEL-QA TWO-TONE FFT PLOT

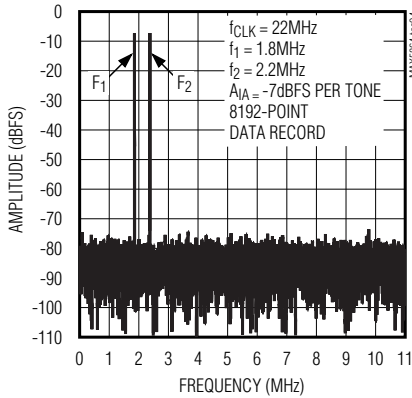

ADC SIGNAL-TO-NOISE RATIO vs. ANALOG INPUT FREQUENCY

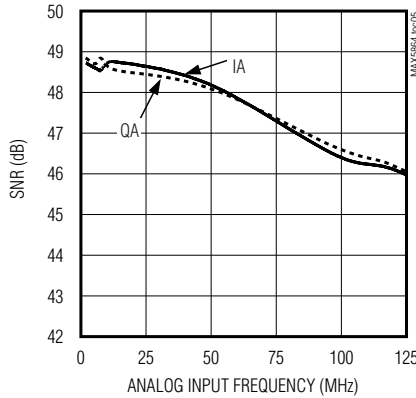

ADC SIGNAL-TO-NOISE AND DISTORTION RATIO vs. ANALOG INPUT FREQUENCY

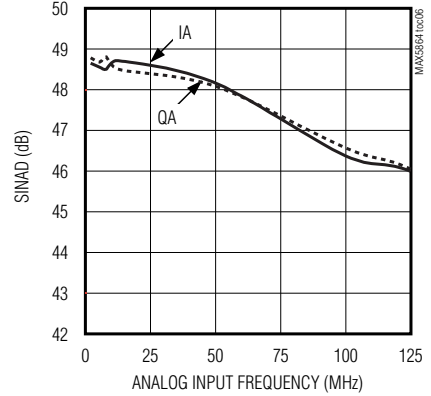

ADC TOTAL HARMONIC DISTORTION vs. ANALOG INPUT FREQUENCY

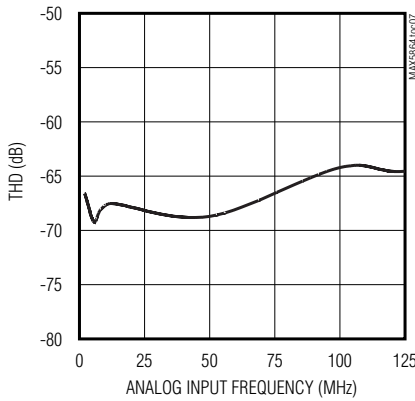

ADC SPURIOUS-FREE DYNAMIC RANGE vs. ANALOG INPUT FREQUENCY

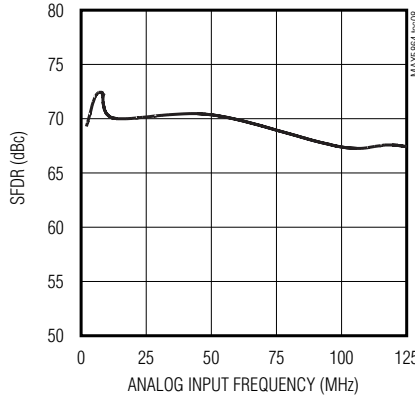

ADC SPURIOUS-FREE DYNAMIC RANGE vs. ANALOG INPUT FREQUENCY

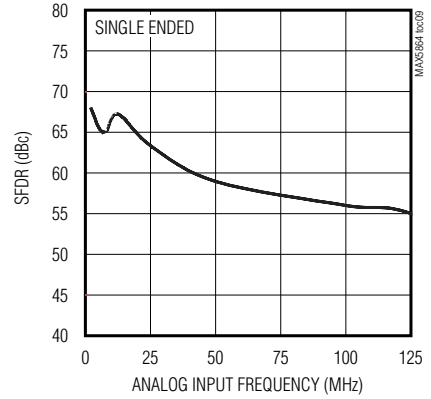

ADC SIGNAL-TO-NOISE-RATIO vs. ANALOG INPUT POWER

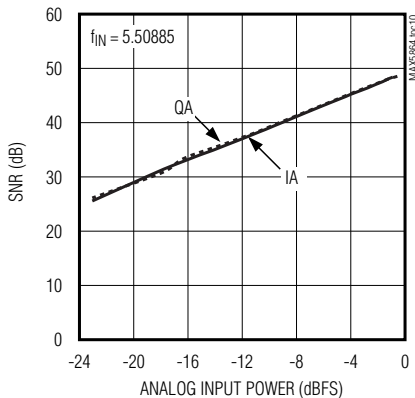

ADC SIGNAL-TO-NOISE-RATIO AND DISTORTION vs. ANALOG INPUT POWER

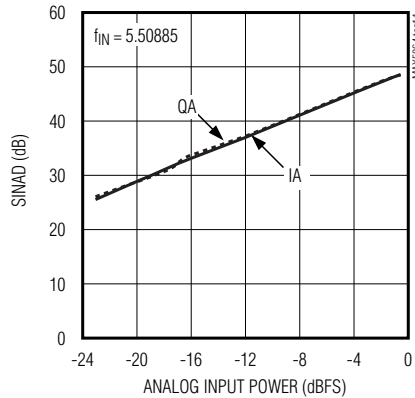

ADC TOTAL HARMONIC DISTORTION vs. ANALOG INPUT POWER

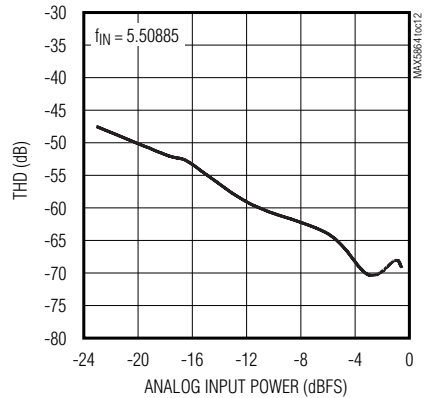

# Ultra-Low-Power, High Dynamic-Performance, 22Mps Analog Front End

MAX5864

## Typical Operating Characteristics (continued)

( $V_{DD} = DV_{DD} = 3V$ ,  $OV_{DD} = 1.8V$ , internal reference (1.024V),  $C_L \approx 10pF$  on all digital outputs,  $f_{CLK} = 22MHz$  50% duty cycle, ADC input amplitude = -0.5dBFS, DAC output amplitude = 0dBFS, differential ADC input, differential DAC output,  $C_{REFP} = C_{REFN} = C_{COM} = 0.33\mu F$ , Xcvr mode,  $T_A = +25^\circ C$ , unless otherwise noted.)

**ADC SPURIOUS-FREE DYNAMIC RANGE vs. ANALOG INPUT POWER**

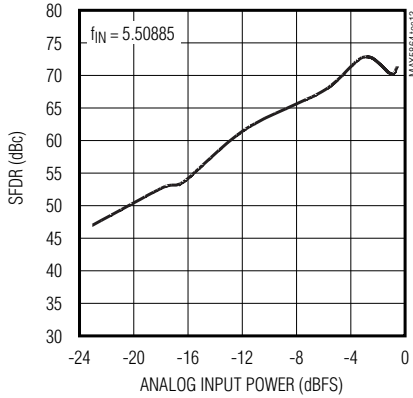

**ADC SIGNAL-TO-NOISE RATIO vs. SAMPLING RATE**

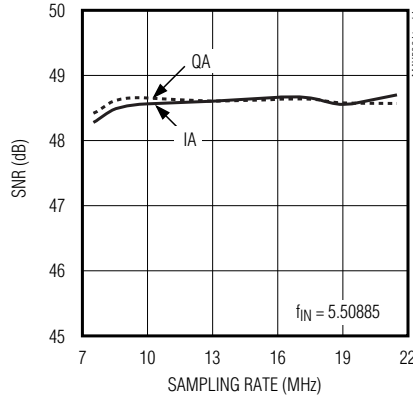

**ADC SIGNAL-TO-NOISE AND DISTORTION RATIO vs. SAMPLING RATE**

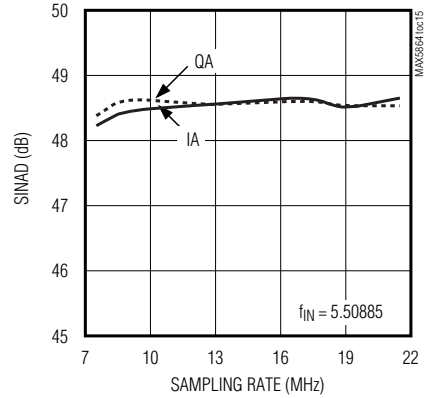

**ADC TOTAL HARMONIC DISTORTION vs. SAMPLING RATE**

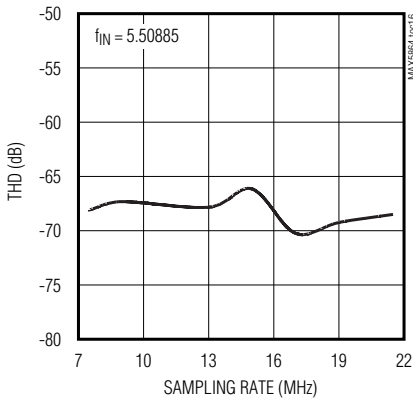

**ADC SPURIOUS-FREE DYNAMIC RANGE vs. SAMPLING RATE**

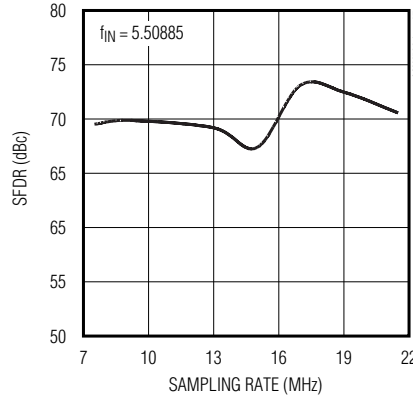

**ADC SIGNAL-TO-NOISE RATIO vs. CLOCK DUTY CYCLE**

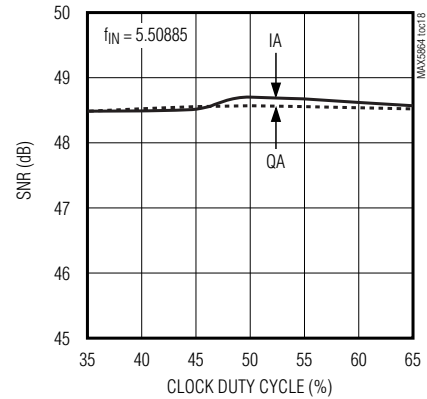

**ADC SIGNAL-TO-NOISE AND DISTORTION RATIO vs. CLOCK DUTY CYCLE**

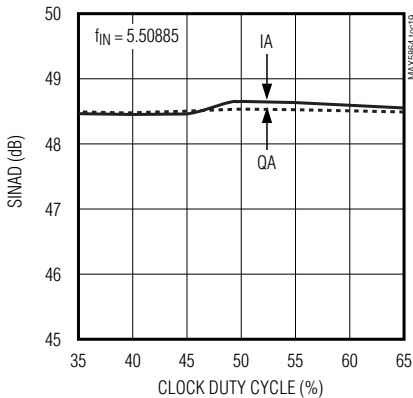

**ADC TOTAL HARMONIC DISTORTION vs. CLOCK DUTY CYCLE**

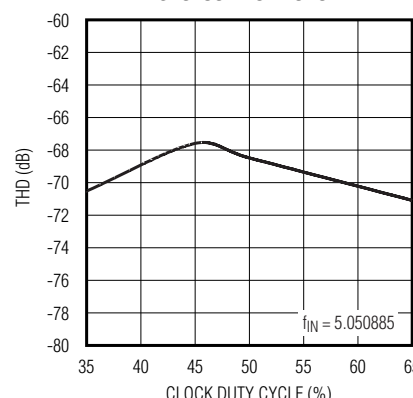

**ADC SPURIOUS-FREE DYNAMIC RANGE vs. CLOCK DUTY CYCLE**

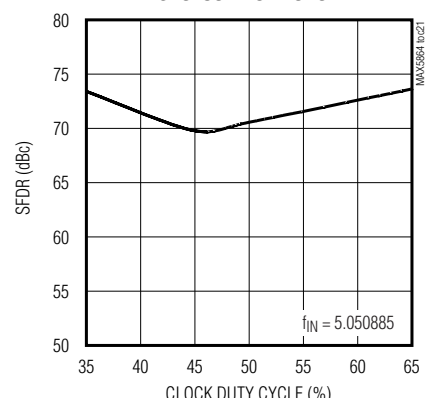

# Ultra-Low-Power, High Dynamic-Performance, 22Mpsps Analog Front End

## Typical Operating Characteristics (continued)

( $V_{DD} = DV_{DD} = 3V$ ,  $OV_{DD} = 1.8V$ , internal reference (1.024V),  $C_L \approx 10pF$  on all digital outputs,  $f_{CLK} = 22MHz$  50% duty cycle, ADC input amplitude =  $-0.5dBFS$ , DAC output amplitude =  $0dBFS$ , differential ADC input, differential DAC output,  $C_{REFP} = C_{REFN} = C_{COM} = 0.33\mu F$ , Xcvr mode,  $T_A = +25^\circ C$ , unless otherwise noted.)

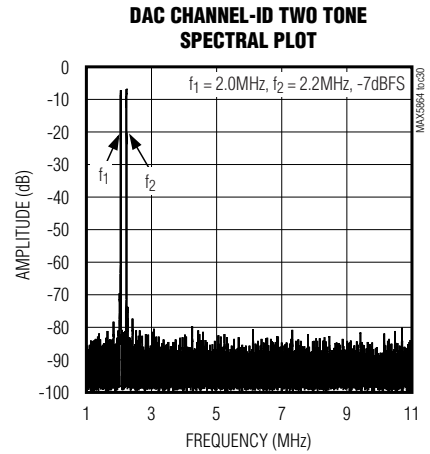
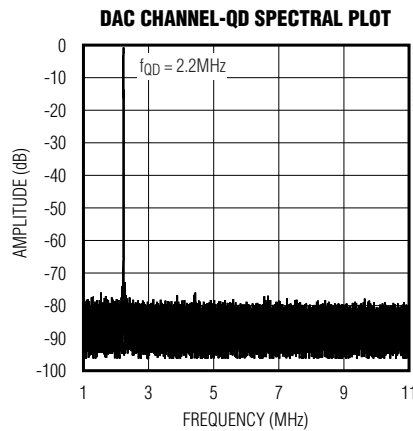
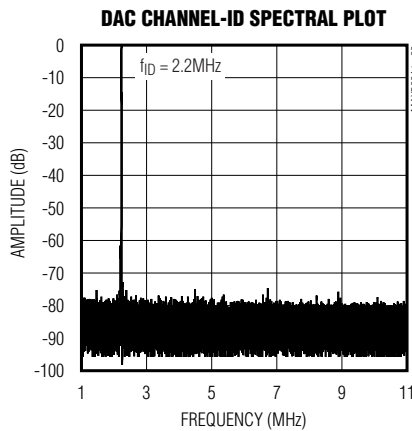
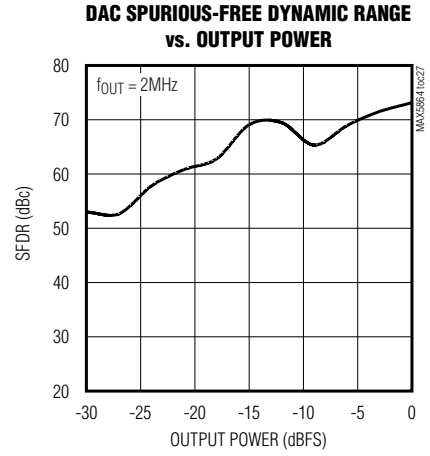
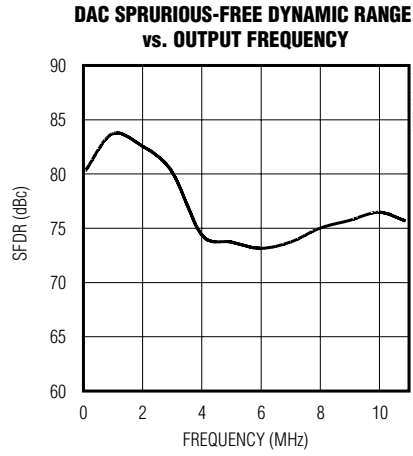
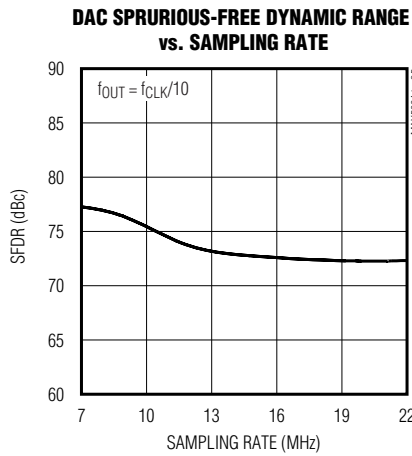
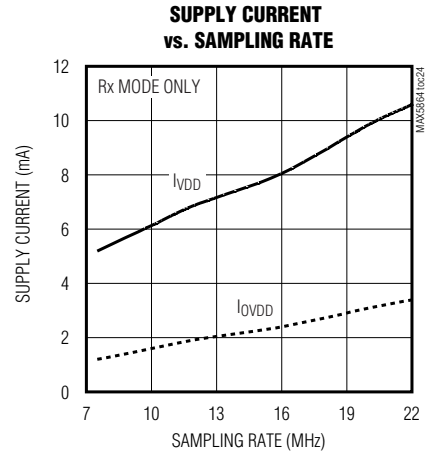
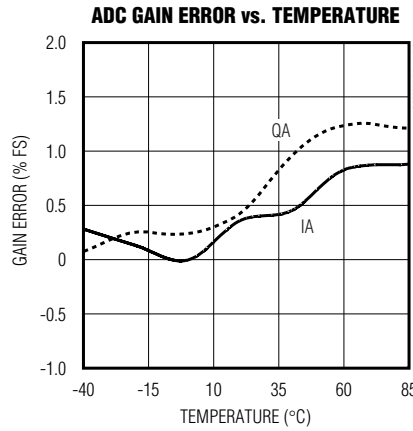
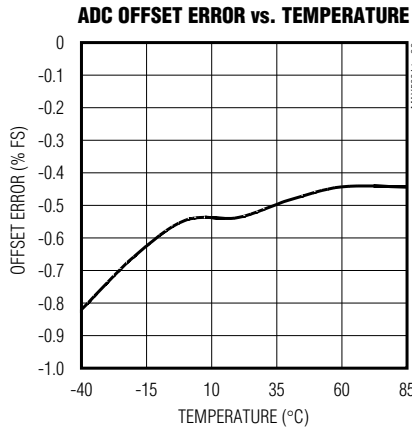

# Ultra-Low-Power, High Dynamic-Performance, 22Mps Analog Front End

MAX5864

## Typical Operating Characteristics (continued)

( $V_{DD} = DV_{DD} = 3V$ ,  $OV_{DD} = 1.8V$ , internal reference (1.024V),  $C_L \approx 10pF$  on all digital outputs,  $f_{CLK} = 22MHz$  50% duty cycle, ADC input amplitude = -0.5dBFS, DAC output amplitude = 0dBFS, differential ADC input, differential DAC output,  $C_{REFP} = C_{REFN} = C_{COM} = 0.33\mu F$ , Xcvr mode,  $T_A = +25^\circ C$ , unless otherwise noted.)

**DAC CHANNEL-QD TWO-TONE SPECTRAL PLOT**

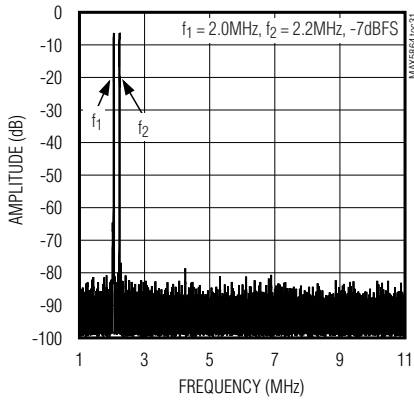

**DAC ACPR SPECTRAL PLOT**

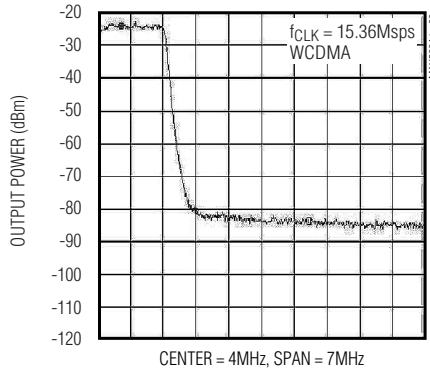

**SUPPLY CURRENT vs. SAMPLING RATE**

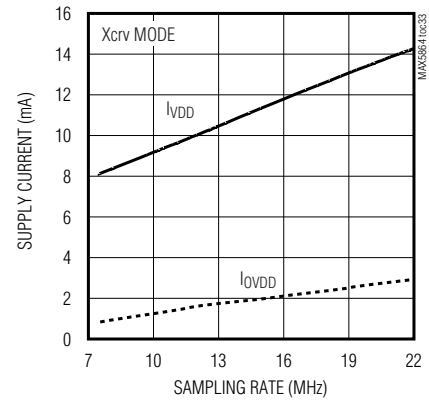

**ADC INTEGRAL NONLINEARITY**

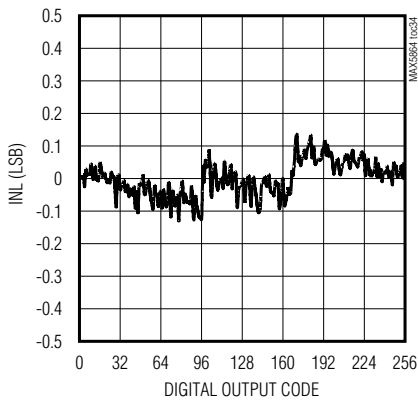

**ADC DIFFERENTIAL NONLINEARITY**

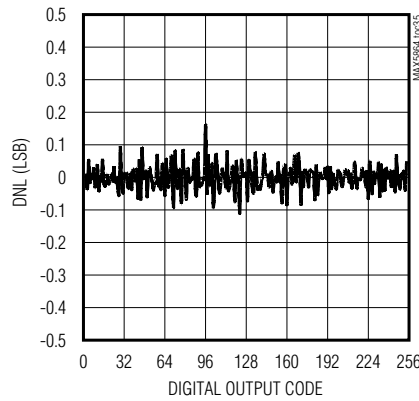

**DAC INTEGRAL NONLINEARITY**

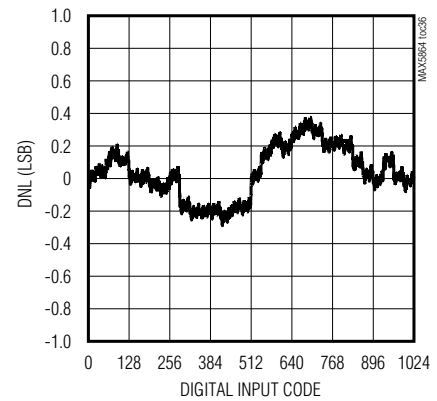

**DAC DIFFERENTIAL NONLINEARITY**

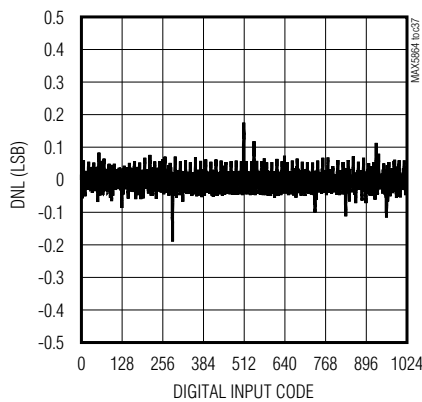

**REFERENCE OUTPUT VOLTAGE vs. TEMPERATURE**

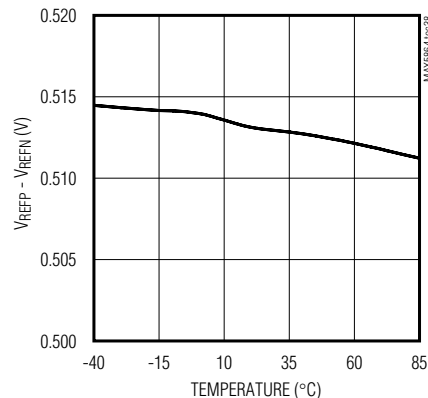

# Ultra-Low-Power, High Dynamic-Performance, 22Msps Analog Front End

## Pin Description

PIN	NAME	FUNCTION
1	REFP	Upper Reference Voltage. Bypass with a 0.33 $\mu$ F capacitor to GND as close to REFP as possible.
2, 8, 43	V <sub>DD</sub>	Analog Supply Voltage. Bypass V <sub>DD</sub> to GND with a combination of a 2.2 $\mu$ F capacitor in parallel with a 0.1 $\mu$ F capacitor.
3	IA+	Channel IA Positive Analog Input. For single-ended operation, connect signal source to IA+.
4	IA-	Channel IA Negative Analog Input. For single-ended operation, connect IA- to COM.
5, 7, 12, 37, 42	GND	Analog Ground. Connect all pins to GND ground plane.
6	CLK	Conversion Clock Input. Clock signal for both ADCs and DACs.
9	QA-	Channel QA Negative Analog Input. For single-ended operation, connect QA- to COM.
10	QA+	Channel QA Positive Analog Input. For single-ended operation, connect signal source to QA+.
11, 33, 39	V <sub>DD</sub>	Analog Supply Voltage. Connect to V <sub>DD</sub> power plane as close to the device as possible.
13–16, 19–22	DA0–DA7	ADC Tri-State Digital Output Bits. DA7 is the most significant bit (MSB), and DA0 is the least significant bit (LSB).
17	OGND	Output Driver Ground
18	OV <sub>DD</sub>	Output Driver Power Supply. Supply range from +1.8V to V <sub>DD</sub> to accommodate most logic levels. Bypass OV <sub>DD</sub> to OGND with a combination of a 2.2 $\mu$ F capacitor in parallel with a 0.1 $\mu$ F capacitor.
23–32	DD0–DD9	DAC Digital Input Bits. DD9 is the MSB, and DD0 is the LSB.
34	DIN	3-Wire Serial Interface Data Input. Data is latched on the rising edge of the SCLK.
35	SCLK	3-Wire Serial Interface Clock Input
36	$\overline{\text{CS}}$	3-Wire Serial Interface Chip Select Input. Apply logic low enables the serial interface.
38	N.C.	No Connection
40, 41	QD+, QD-	DAC Channel-QD Differential Voltage Output
44, 45	ID-, ID+	DAC Channel-ID Differential Voltage Output
46	REFIN	Reference Input. Connect to V <sub>DD</sub> for internal reference.
47	COM	Common-Mode Voltage I/O. Bypass COM to GND with a 0.33 $\mu$ F capacitor.
48	REFN	Negative Reference I/O. Conversion range is $\pm(V_{\text{REFP}} - V_{\text{REFN}})$ . Bypass REFN to GND with a 0.33 $\mu$ F capacitor.
—	EP	Exposed Paddle. Exposed paddle is internally connected to GND. Connect EP to the GND plane.

# Ultra-Low-Power, High Dynamic-Performance, 22MSPS Analog Front End

**MAX5864**

## Detailed Description

The MAX5864 integrates dual 8-bit receive ADCs and dual 10-bit transmit DACs while providing ultra-low power and highest dynamic performance at a conversion rate of 22MSPS. The ADCs' analog input amplifiers are fully differential and accept 1V<sub>P-P</sub> full-scale signals. The DACs' analog outputs are fully differential with  $\pm 400\text{mV}$  full-scale output range at 1.4V common mode.

The MAX5864 includes a 3-wire serial interface to control operating modes and power management. The serial interface is SPI™ and MICROWIRE™ compatible. The MAX5864 serial interface selects shutdown, idle, standby, transmit, receive, and transceiver modes.

The MAX5864 can operate in FDD or TDD applications by configuring the device for transmit, receive, or transceiver modes through a 3-wire serial interface. In TDD mode, the digital bus for receive ADC and transmit DAC can be shared to reduce the digital I/O to a single 10-bit parallel multiplexed bus. In FDD mode, the MAX5864 digital I/O can be configured for an 18-bit, parallel multiplexed bus to match the dual 8-bit ADC and dual 10-bit DAC.

The MAX5864 features an internal precision 1.024V bandgap reference is stable over the entire power-supply and temperature ranges.

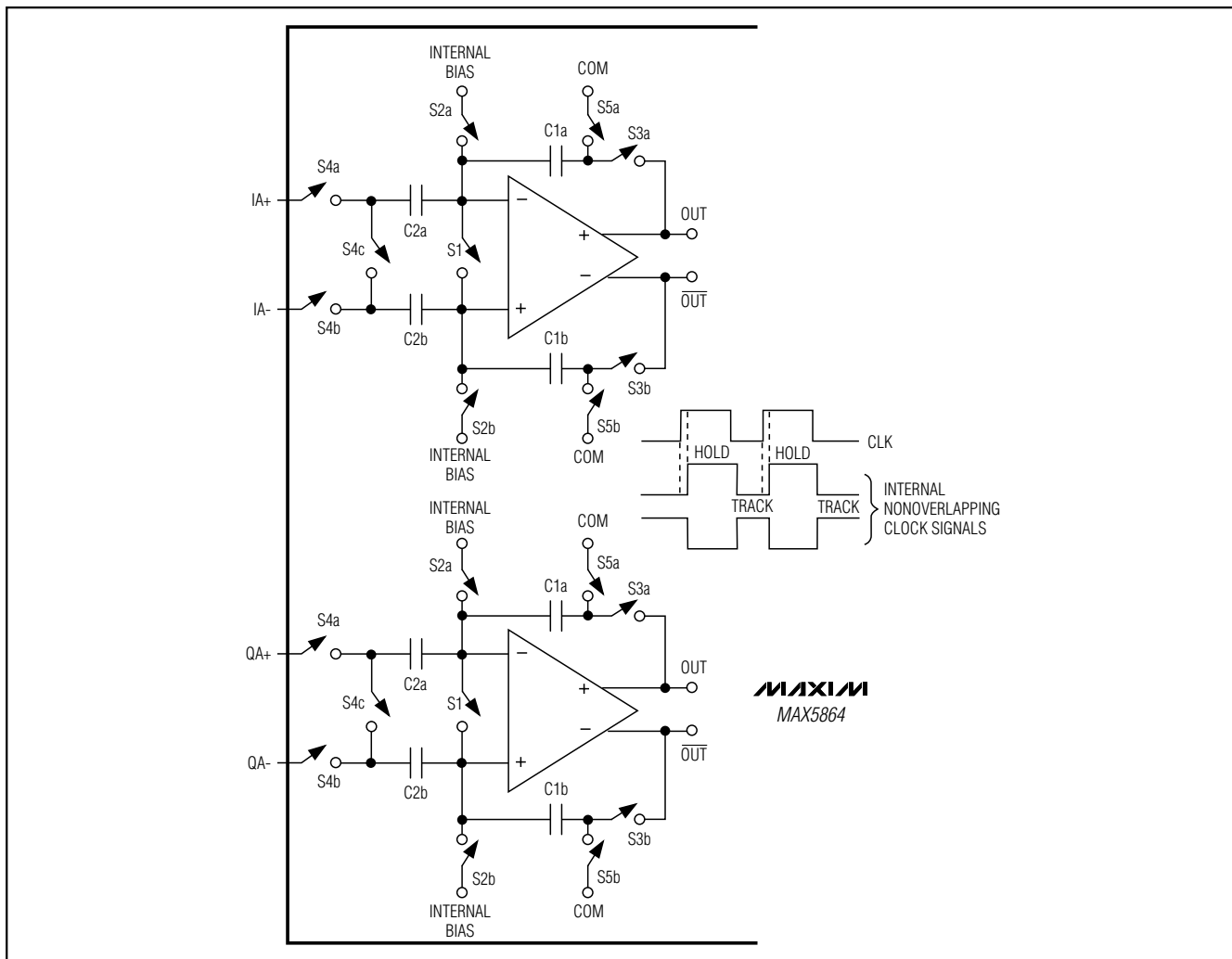

Figure 1. MAX5864 ADC Internal T/H Circuits

SPI is a trademark of Motorola, Inc. MICROWIRE is a trademark of National Semiconductor Corp.

# Ultra-Low-Power, High Dynamic-Performance, 22MSPS Analog Front End

## Dual 8-Bit ADC

The ADC uses a seven-stage, fully differential, pipelined architecture that allows for high-speed conversion while minimizing power consumption. Samples taken at the inputs move progressively through the pipeline stages every half-clock cycle. Including the delay through the output latch, the total clock-cycle latency is 5 clock cycles for channel IA and 5.5 clock cycles for channel QA. The ADC's full-scale analog input range is  $\pm V_{REF}$  with a common-mode input range of  $V_{DD}/2 \pm 0.2V$ .  $V_{REF}$  is the difference between  $V_{REFP}$  and  $V_{REFN}$ . See the *Reference Configurations* section for details.

## Input Track-and-Hold (T/H) Circuits

Figure 1 displays a simplified functional diagram of the ADC's input T/H circuitry. In track mode, switches S1, S2a, S2b, S4a, S4b, S5a, and S5b are closed. The fully differential circuits sample the input signals onto the two capacitors (C2a and C2b) through switches S4a and S4b. S2a and S2b set the common mode for the amplifier input, and open simultaneously with S1, sampling the input waveform. Switches S4a, S4b, S5a, and S5b are then opened before switches S3a and S3b connect capacitors C1a and C1b to the output of the amplifier and switch S4c is closed. The resulting differential voltages are held on capacitors C2a and C2b.

The amplifiers charge capacitors C1a and C1b to the same values originally held on C2a and C2b. These values are then presented to the first-stage quantizers and isolate the pipelines from the fast-changing inputs. The wide input bandwidth T/H amplifiers allow the ADC to track and sample/hold analog inputs of high frequencies ( $>$  Nyquist). Both ADC inputs (IA+, QA+, IA-, and QA-) can be driven either differentially or single ended. Match the impedance of IA+ and IA-, as well as QA+ and QA-, and set the common-mode voltage to mid-supply ( $V_{DD}/2$ ) for optimum performance.

## ADC Digital Output Data (DA0–DA7)

DA0–DA7 are the ADCs' digital logic outputs. The logic level is set by  $OV_{DD}$  from 1.8V to  $V_{DD}$ . The digital output coding is offset binary (Table 1, Figure 2). The capacitive load on digital outputs DA0–DA7 should be kept as low as possible ( $<$ 15pF) to avoid large digital currents feeding back into the analog portion of the MAX5864 and degrading its dynamic performance. Buffers on the digital outputs isolate them from heavy capacitive loads. Adding 100 $\Omega$  resistors in series with the digital outputs close to the MAX5864 helps improve ADC performance. Refer to the MAX5865 EV kit schematic for an example of the digital outputs driving a digital buffer through 100 $\Omega$  series resistors.

**Table 1. Output Codes vs. Input Voltage**

DIFFERENTIAL INPUT VOLTAGE	DIFFERENTIAL INPUT (LSB)	OFFSET BINARY (DA7–DA0)	OUTPUT DECIMAL CODE
$V_{REF} \times \frac{127}{128}$	127 (+full scale - 1LSB)	1111 1111	255
$V_{REF} \times \frac{126}{128}$	126 (+full scale - 2LSB)	1111 1110	254
$V_{REF} \times \frac{1}{128}$	+1	1000 0001	129
$V_{REF} \times \frac{0}{128}$	0 (bipolar zero)	1000 0000	128
$-V_{REF} \times \frac{1}{128}$	-1	0111 1111	127
$-V_{REF} \times \frac{127}{128}$	-127 (-full scale + 1LSB)	0000 0001	1
$-V_{REF} \times \frac{128}{128}$	-128 (-full scale)	0000 0000	0

# Ultra-Low-Power, High Dynamic-Performance, 22MSPS Analog Front End

## ADC System Timing Requirements

Figure 3 shows the relationship between the clock, analog inputs, and the resulting output data. Channel IA (CHI) and channel QA (CHQ) are simultaneously sampled on the rising edge of the clock signal (CLK) and the resulting data is multiplexed at the DA0–DA7 out-

puts. CHI data is updated on the rising edge and CHQ data is updated on the falling edge of the CLK. Including the delay through the output latch, the total clock-cycle latency is 5 clock cycles for CHI and 5.5 clock cycles for CHQ.

## Dual 10-Bit DAC

The 10-bit DACs are capable of operating with clock speeds up to 22MHz. The DAC's digital inputs, DD0–DD9, are multiplexed on a single 10-bit bus. The voltage reference determines the data converters' full-scale output voltages. See the *Reference Configurations* section for setting reference voltage. The DACs utilize a current-array technique with a 1mA (with 1.024V reference) full-scale output current driving a 400Ω internal resistor resulting in a ±400mV full-scale differential output voltage. The MAX5864 is designed for differential output only and is not intended for single-ended application. The analog outputs are biased at 1.4V common mode and designed to drive a differential input stage with input impedance ≥70kΩ. This simplifies the analog interface between RF quadrature upconverters and the MAX5864. RF upconverters require a 1.3V to 1.5V common-mode bias. The internal DC common-mode bias eliminates discrete level setting resistors and code-generated level-shifting while preserving the full dynamic range of each transmit DAC. Table 2 shows the output voltage vs. input code.

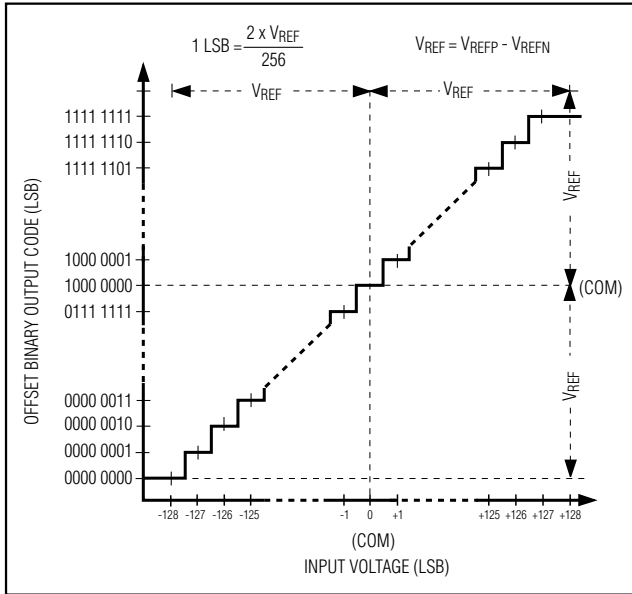

Figure 2. ADC Transfer Function

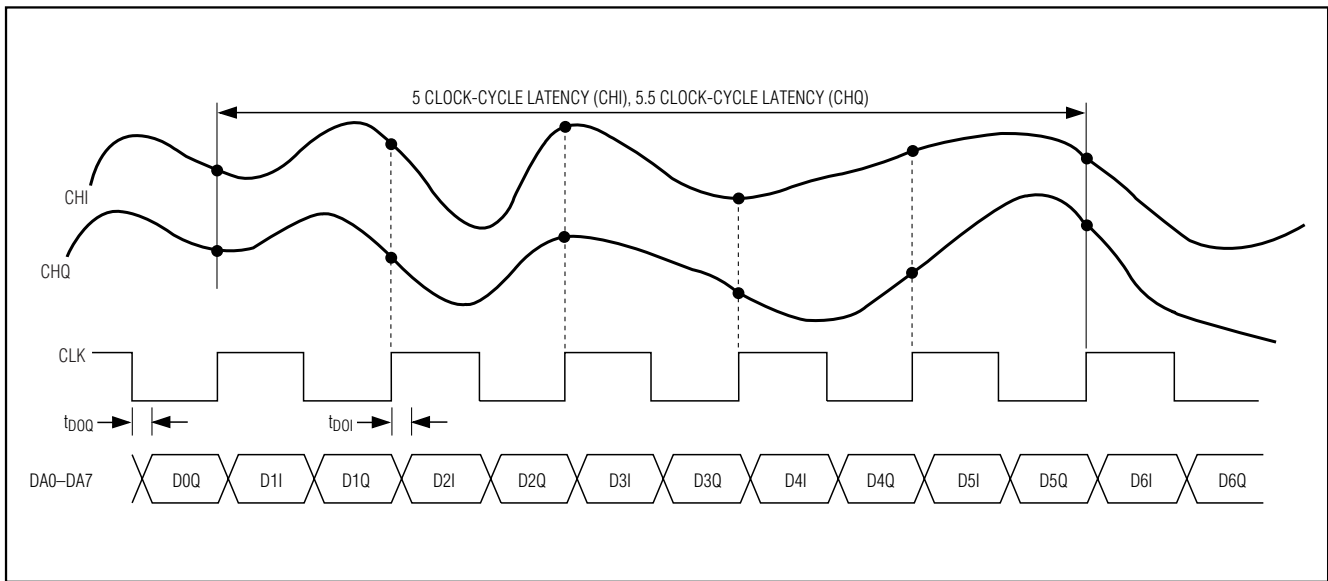

Figure 3. ADC System Timing Diagram

# Ultra-Low-Power, High Dynamic-Performance, 22MSPS Analog Front End

**Table 2. DAC Output Voltage vs. Input Codes (Internal Reference Mode VREFDAC = 1.024V, External Reference Mode VREFDAC = VREFIN)**

DIFFERENTIAL OUTPUT VOLTAGE	OFFSET BINARY (DD0–DD9)	INPUT DECIMAL CODE
$\frac{V_{REFDAC}}{2.56} \times \frac{1023}{1023}$	11 1111 1111	1023
$\frac{V_{REFDAC}}{2.56} \times \frac{1021}{1023}$	11 1111 1110	1022
$\frac{V_{REFDAC}}{2.56} \times \frac{3}{1023}$	10 0000 0001	513
$\frac{V_{REFDAC}}{2.56} \times \frac{1}{1023}$	10 0000 0000	512
$-\frac{V_{REFDAC}}{2.56} \times \frac{1}{1023}$	01 1111 1111	511
$-\frac{V_{REFDAC}}{2.56} \times \frac{1021}{1023}$	00 0000 0001	1
$-\frac{V_{REFDAC}}{2.56} \times \frac{1023}{1023}$	00 0000 0000	0

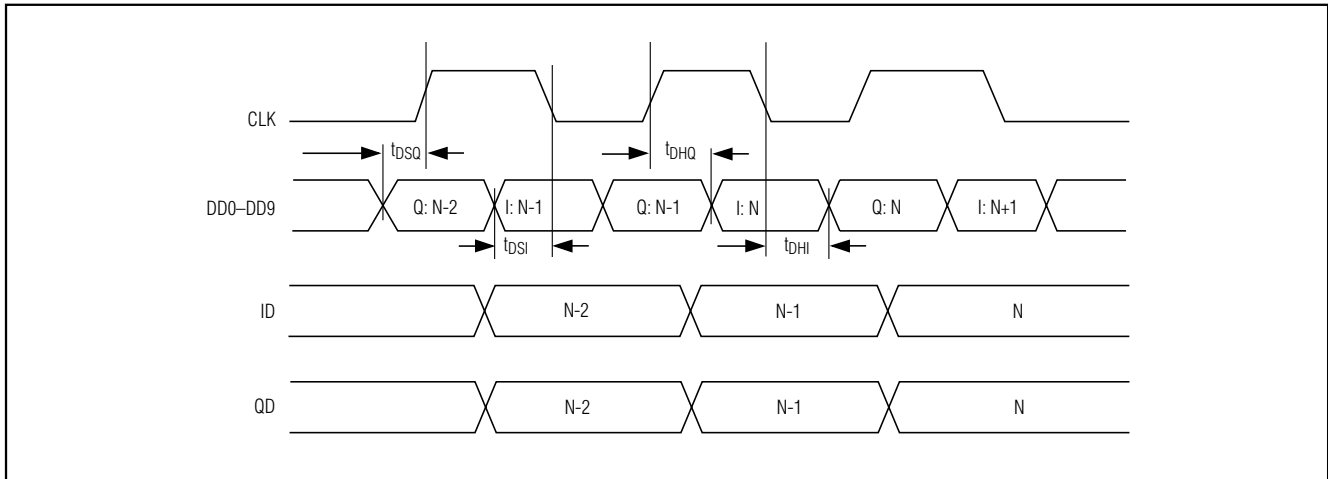

Figure 4. DAC System Timing Diagram

### DAC Timing

Figure 4 shows the relationship between the clock, input data, and analog outputs. Data for the I channel (ID) is latched on the falling edge of the clock signal, and Q-channel (QD) data is latched on the rising edge of the clock signal. Both I and Q outputs are simultaneously updated on the next rising edge of the clock signal.

### 3-Wire Serial Interface and Operation Modes

The 3-wire serial interface controls the MAX5864 operation modes. Upon power-up, the MAX5864 must be programmed to operate in the desired mode. Use the 3-wire serial interface to program the device for the shut-down, idle, standby, Rx, Tx, or Xcvr mode. An 8-bit data register sets the operation modes as shown in Table 3. The serial interface remains active in all six modes.

# Ultra-Low-Power, High Dynamic-Performance, 22MSPS Analog Front End

**Table 3. MAX5864 Operation Modes**

<b>FUNCTION</b>	<b>DESCRIPTION</b>	<b>D7 (MSB)</b>	<b>D6</b>	<b>D5</b>	<b>D4</b>	<b>D3</b>	<b>D2</b>	<b>D1</b>	<b>D0</b>
Shutdown	Device shutdown. REF is off, ADCs are off, and the ADC bus is tri-stated; DACs are off and the DAC input bus must be set to zero or $OV_{DD}$ .	X	X	X	X	X	0	0	0
Idle	REF and CLK are on, ADCs are off, and the ADC bus is tri-stated; DACs are off and the DAC input bus must be set to zero or $OV_{DD}$ .	X	X	X	X	X	0	0	1
Rx	REF is on, ADCs are on; DACs are off, and the DAC input bus must be set to zero or $OV_{DD}$ .	X	X	X	X	X	0	1	0
Tx	REF is on, ADCs are off, and the ADC bus is tri-stated; DACs are on.	X	X	X	X	X	0	1	1
Xcvr	REF is on, ADCs and DACs are on.	X	X	X	X	X	1	0	0
Standby	REF is on, ADCs are off, and the ADC bus is tri-stated; DACs are off and the DAC input bus must be set to zero or $OV_{DD}$ .	X	X	X	X	X	1	0	1

*X = Don't care.*

Shutdown mode offers the most dramatic power savings by shutting down all the analog sections of the MAX5864 and placing the ADCs' digital outputs in tri-state mode. When the ADCs' outputs transition from tri-state to on, the last converted word is placed on the digital outputs. The DACs' digital bus inputs must be zero or  $OV_{DD}$  because the bus is not internally pulled up. The DACs' previously stored data is lost when coming out of shutdown mode. The wake-up time from shutdown mode is dominated by the time required to charge the capacitors at REFP, REFN, and COM. In internal reference mode and buffered external reference mode, the wake-up time is typically 40 $\mu$ s to enter Xcvr mode, 20 $\mu$ s to enter Rx mode, and 40 $\mu$ s to enter Tx mode.

In idle mode, the reference and clock distribution circuits are powered, but all other functions are off. The ADCs' outputs are forced to tri-state. The DACs' digital bus inputs must be zero or  $OV_{DD}$ , because the bus is not internally pulled up. The wake-up time from the idle mode is 10 $\mu$ s required for the ADCs and DACs to be fully operational. When the ADCs' outputs transition from tri-state to on, the last converted word is placed on the digital outputs. In the idle mode, the supply current is lowered if the clock input is set to zero or  $OV_{DD}$ ; however, the wake-up time extends to 40 $\mu$ s.

*QSPI is a trademark of Motorola, Inc.*

In standby mode, only the ADCs' reference is powered; the rest of the device's functions are off. The pipeline ADCs are off and DA0 to DA7 are in tri-state mode. The DACs' digital bus inputs must be zero or  $OV_{DD}$  because the bus is not internally pulled up. The wake-up time from standby mode to the Xcvr mode is dominated by the 40 $\mu$ s required to activate the pipeline ADCs and DACs. When the ADC outputs transition from tri-state to active, the last converted word is placed on the digital outputs.

The serial digital interface is a standard 3-wire connection compatible with SPI/QSPI™/MICROWIRE/DSP interfaces. Set  $\overline{CS}$  low to enable the serial data loading at DIN. Following  $\overline{CS}$  high-to-low transition, data is shifted synchronously, MSB first, on the rising edge of the serial clock (SCLK). After 8 bits are loaded into the serial input register, data is transferred to the latch.  $\overline{CS}$  must transition high for a minimum of 80ns before the next write sequence. The SCLK can idle either high or low between transitions. Figure 5 shows the detailed timing diagram of the 3-wire serial interface.

# Ultra-Low-Power, High Dynamic-Performance, 22Mps Analog Front End

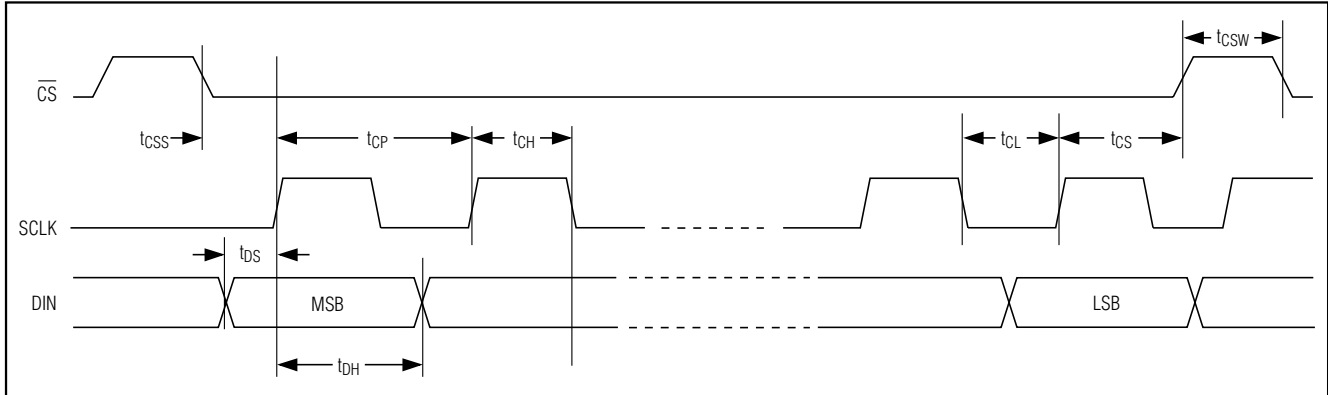

Figure 5. 3-Wire Serial Interface Timing Diagram

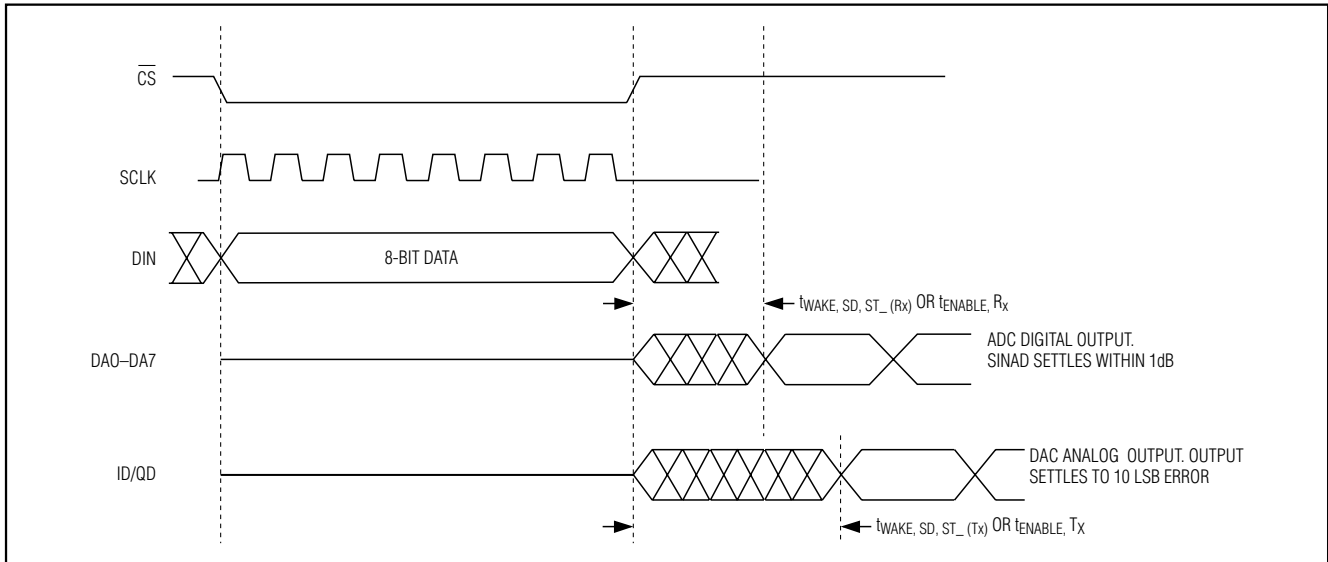

Figure 6. MAX5864 Mode Recovery Timing Diagram

### Mode Recovery Timing

Figure 6 shows the mode recovery timing diagram.  $t_{WAKE}$  is the wake-up time when exiting shutdown, idle, or standby mode and entering into Rx, Tx, or Xcvr mode.  $t_{ENABLE}$  is the recovery time when switching between any Rx, Tx, or Xcvr mode.  $t_{WAKE}$  or  $t_{ENABLE}$  is the time for the ADC to settle within 1dB of specified SINAD performance and DAC settling to 10 LSB error.  $t_{WAKE}$  or  $t_{ENABLE}$  times are measured after the 8-bit serial command is latched into the MAX5864 by  $\overline{CS}$  transition high.  $t_{ENABLE}$  for Xcvr mode is dominated by the DAC wake-up time. The recovery time is 10 $\mu$ s to switch between Xcvr, Tx, or Rx modes. The recovery time is 40 $\mu$ s to switch from shutdown or standby mode to Xcvr mode.

### System Clock Input (CLK)

CLK input is shared by both the ADCs and DACs. It accepts a CMOS-compatible signal level set by  $OV_{DD}$  from 1.8V to  $V_{DD}$ . Since the interstage conversion of the device depends on the repeatability of the rising and falling edges of the external clock, use a clock with low jitter and fast rise and fall times (<2ns). Specifically, sampling occurs on the rising edge of the clock signal, requiring this edge to provide the lowest possible jitter. Any significant clock jitter limits the SNR performance of the on-chip ADCs as follows:

$$SNR = 20 \times \log \left( \frac{1}{2 \times \pi \times f_{IN} \times t_{AJ}} \right)$$

where  $f_{IN}$  represents the analog input frequency and  $t_{AJ}$  is the time of the clock jitter.

# Ultra-Low-Power, High Dynamic-Performance, 22MSPS Analog Front End

Clock jitter is especially critical for undersampling applications. Consider the clock input as an analog input and route away from any analog input or other digital signal lines. The MAX5864 clock input operates with an  $OV_{DD}/2$  voltage threshold and accepts a 50%  $\pm 15\%$  duty cycle.

## Reference Configurations

The MAX5864 features an internal precision 1.024V bandgap reference is stable over the entire power supply and temperature range. The REFIN input provides two modes of reference operation. The voltage at REFIN ( $V_{REFIN}$ ) sets reference operation mode (Table 4).

In internal reference mode, connect REFIN to  $V_{DD}$ .  $V_{REF}$  is an internally generated 0.512V. COM, REFP, and REFN are low-impedance outputs with  $V_{COM} = V_{DD}/2$ ,  $V_{REFP} = V_{DD}/2 + V_{REF}/2$ , and  $V_{REFN} = V_{DD}/2 - V_{REF}/2$ . Bypass REFP, REFN, and COM each with a 0.33 $\mu$ F capacitor. Bypass REFIN to GND with a 0.1 $\mu$ F capacitor.

In buffered external reference mode, apply 1.024V  $\pm 10\%$  at REFIN. In this mode, COM, REFP, and REFN are low-impedance outputs with  $V_{COM} = V_{DD}/2$ ,  $V_{REFP} = V_{DD}/2 + V_{REFIN}/4$ , and  $V_{REFN} = V_{DD}/2 - V_{REFIN}/4$ . Bypass REFP, REFN, and COM each with a 0.33 $\mu$ F capacitor. Bypass REFIN to GND with a 0.1 $\mu$ F capacitor. In this mode, the DAC's full-scale output voltage and common-mode voltage are proportional to the external reference. For example, if the  $V_{REFIN}$  is increased by 10% (max), the DACs' full-scale output voltage is also increased by 10% or  $\pm 440$ mV, and the common-mode voltage increases by 10%.

**Table 4. Reference Modes**

$V_{REFIN}$	REFERENCE MODE
$>0.8 \times V_{DD}$	Internal reference mode. $V_{REF}$ is internally generated to be 0.512V. Bypass REFP, REFN, and COM each with a 0.33 $\mu$ F capacitor.
1.024V $\pm 10\%$	Buffered external reference mode. An external 1.024V $\pm 10\%$ reference voltage is applied to REFIN. $V_{REF}$ is internally generated to be $V_{REFIN}/2$ . Bypass REFP, REFN, and COM each with a 0.33 $\mu$ F capacitor. Bypass REFIN to GND with a 0.1 $\mu$ F capacitor.

## Applications Information

### Using Balun Transformer AC-Coupling

An RF transformer (Figure 7) provides an excellent solution to convert a single-ended signal source to a fully differential signal for optimum ADC performance. Connecting the center tap of the transformer to COM provides a  $V_{DD}/2$  DC level shift to the input. A 1:1 transformer can be used, or a step-up transformer can be selected to reduce the drive requirements. In general, the MAX5864 provides better SFDR and THD with fully differential input signals than single-ended signals, especially for high-input frequencies. In differential mode, even-order harmonics are lower as both inputs ( $IA+$ ,  $IA-$ ,  $QA+$ ,  $QA-$ ) are balanced, and each of the ADC inputs only requires half the signal swing compared to single-ended mode. Figure 8 shows an RF transformer converting the MAX5864 DACs' differential analog outputs to single ended.

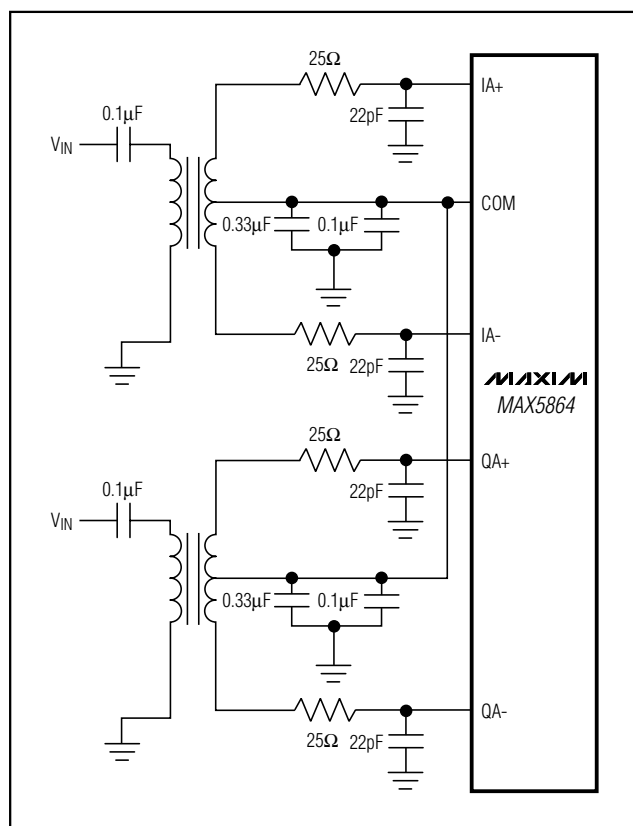

Figure 7. Balun-Transformer Coupled Single-Ended to Differential Input Drive for ADCs

# Ultra-Low-Power, High Dynamic-Performance, 22MSPS Analog Front End

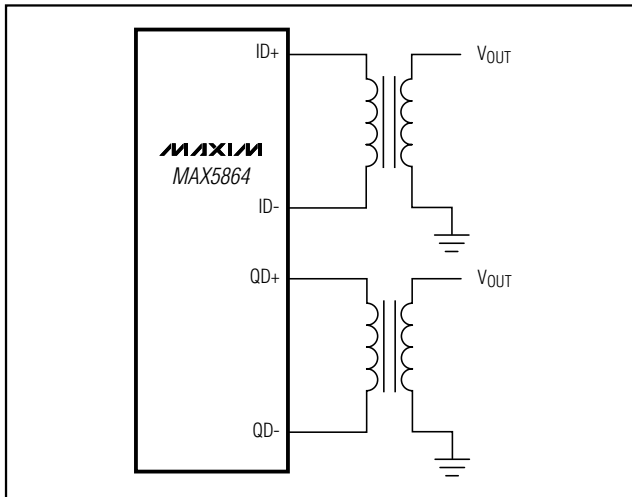

Figure 8. Balun-Transformer Coupled Differential to Single-Ended Output Drive for DACs

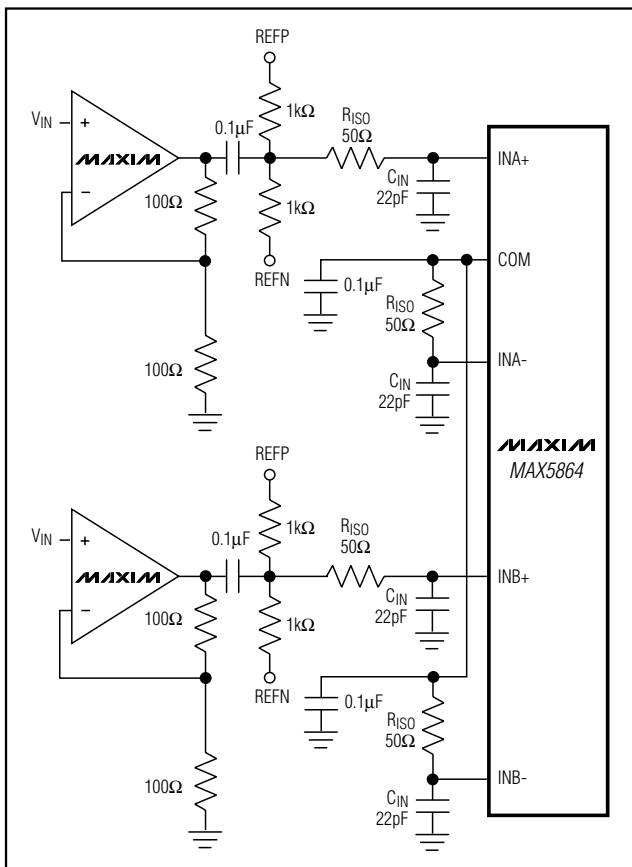

Figure 9. Single-Ended Drive for ADCs

## Using Op-Amp Coupling

Drive the MAX5864 ADCs with op amps when a balun transformer is not available. Figures 9 and 10 show the ADCs being driven by op amps for AC-coupled single-ended, and DC-coupled differential applications. Amplifiers such as the MAX4354/MAX4454 provide high speed, high bandwidth, low noise, and low distortion to maintain the input signal integrity. Figure 10 can also be used to interface with the DAC differential analog outputs to provide gain or buffering. The DAC differential analog outputs cannot be used in single-ended mode because of the internally generated 1.4VDC common-mode level. Also, the DAC analog outputs are designed to drive a differential input stage with input impedance  $\geq 70k\Omega$ . If single-ended outputs are desired, use an amplifier to provide differential to single-ended conversion and select an amplifier with proper input common-mode voltage range.

## FDD and TDD Modes

The MAX5864 can be used in diverse applications operating FDD or TDD modes. The MAX5864 operates in Xcvr mode for FDD applications such as WCDMA-3GPP (FDD) and 4G technologies. Also, the MAX5864 can switch between Tx and Rx modes for TDD applications like TD-SCDMA, WCDMA-3GPP (TDD), IEEE802.11a/b/g, and IEEE802.16.

In FDD mode, the ADC and DAC operate simultaneously. The ADC bus and DAC bus are dedicated and must be connected in 18-bit parallel (8-bit ADC and 10-bit DAC) to the digital baseband processor. Select Xcvr mode through the 3-wire serial interface and use the conversion clock to latch data. In FDD mode, the MAX5864 uses 34mW power at  $f_{CLK} = 15.36\text{MHz}$ . This is the total power of the ADC and DAC operating simultaneously.

In TDD mode, the ADC and DAC operate independently. The ADC and DAC bus are shared and can be connected together, forming a single 10-bit parallel bus to the digital baseband processor. Using the 3-wire serial interface, select between Rx mode to enable the ADC and Tx mode to enable the DAC. When operating in Rx mode, the DAC does not transmit because the core is disabled and in Tx mode, the ADC bus is tri-state. This eliminates any unwanted spurious emissions and prevents bus contention. In TDD mode, the MAX5864 uses 24.7mW power in Rx mode at  $f_{CLK} = 15.36\text{MHz}$ , and the DAC uses 24mW in Tx mode.

# Ultra-Low-Power, High Dynamic-Performance, 22MSPS Analog Front End

**MAX5864**

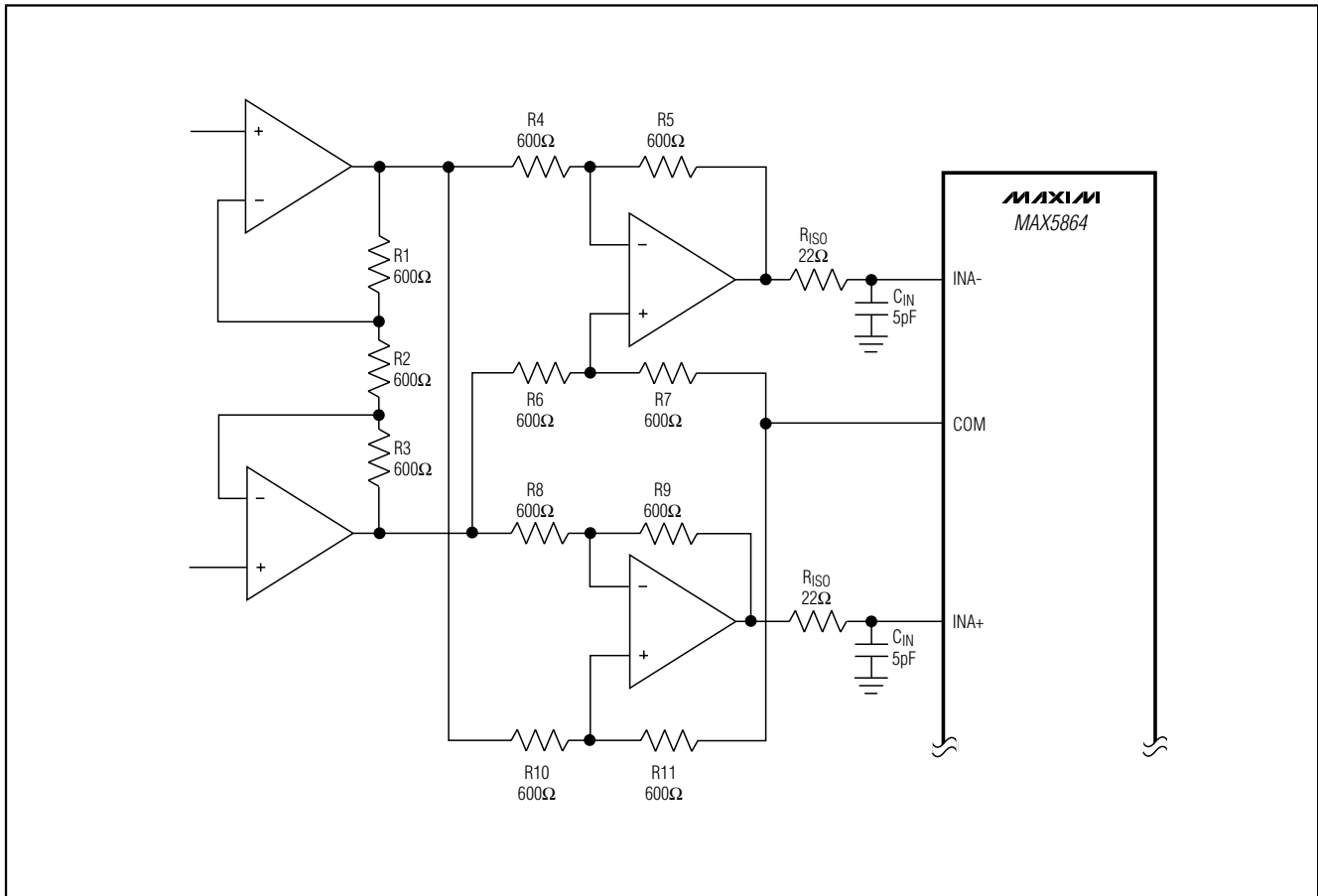

Figure 10. ADC DC-Coupled Differential Drive

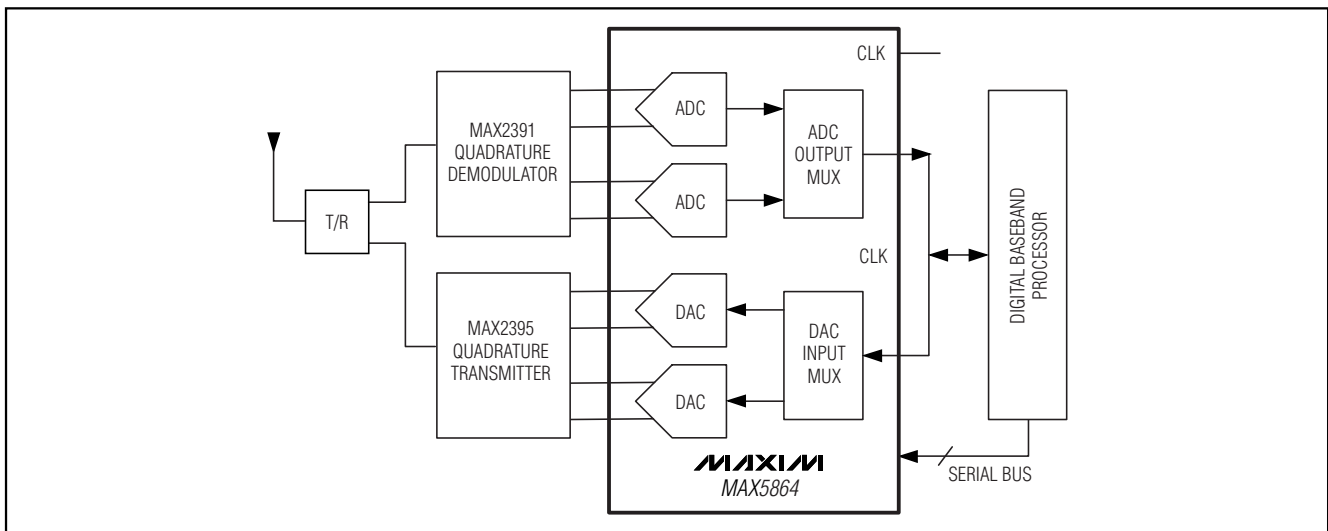

Figure 11. Typical Application Circuit for TDD

# Ultra-Low-Power, High Dynamic-Performance, 22MSPS Analog Front End

Figure 11 illustrates the MAX5864 working with the MAX2391 and MAX2395 in TDD mode to provide a complete radio front-end solution. Because the MAX5864 DAC has full differential analog outputs with a common-mode level of 1.4V, it can interface directly with RF quadrature modulators while eliminating discrete components and amplifiers used for level-shifting circuits. Also, the DAC's full dynamic range is preserved because the internally generated common-mode level eliminates code-generated level shifting or attenuation due to resistor level shifting. The MAX5864 ADC has 1V<sub>P-P</sub> full-scale range and accepts input common-mode levels of  $V_{DD}/2$  ( $\pm 200\text{mV}$ ). These features simplify the analog interface between RF quadrature demodulator and ADC while eliminating discrete gain amplifiers and level-shifting components.

## Grounding, Bypassing, and Board Layout

The MAX5864 requires high-speed board layout design techniques. Refer to the MAX5865 EV kit data sheet for a board layout reference. Locate all bypass capacitors as close to the device as possible, preferably on the same side of the board as the device, using surface-mount devices for minimum inductance. Bypass  $V_{DD}$  to GND with a 0.1 $\mu\text{F}$  ceramic capacitor in parallel with a 2.2 $\mu\text{F}$  capacitor. Bypass  $OV_{DD}$  to OGND with a 0.1 $\mu\text{F}$

ceramic capacitor in parallel with a 2.2 $\mu\text{F}$  capacitor. Bypass REFP, REFN, and COM each to GND with a 0.33 $\mu\text{F}$  ceramic capacitor. Bypass REFIN to GND with a 0.1 $\mu\text{F}$  capacitor.

Multilayer boards with separated ground and power planes yield the highest level of signal integrity. Use a split ground plane arranged to match the physical location of the analog ground (GND) and the digital output driver ground (OGND) on the device package. Connect the MAX5864 exposed backside paddle to the GND plane. Join the two ground planes at a single point such that the noisy digital ground currents do not interfere with the analog ground plane. The ideal location for this connection can be determined experimentally at a point along the gap between the two ground planes. Make this connection with a low-value, surface-mount resistor (1 $\Omega$  to 5 $\Omega$ ), a ferrite bead, or a direct short. Alternatively, all ground pins could share the same ground plane, if the ground plane is sufficiently isolated from any noisy digital system's ground plane (e.g., downstream output buffer or DSP ground plane).

Route high-speed digital signal traces away from sensitive analog traces. Make sure to isolate the analog input lines to each respective converter to minimize channel-to-channel crosstalk. Keep all signal lines short and free of 90° turns.

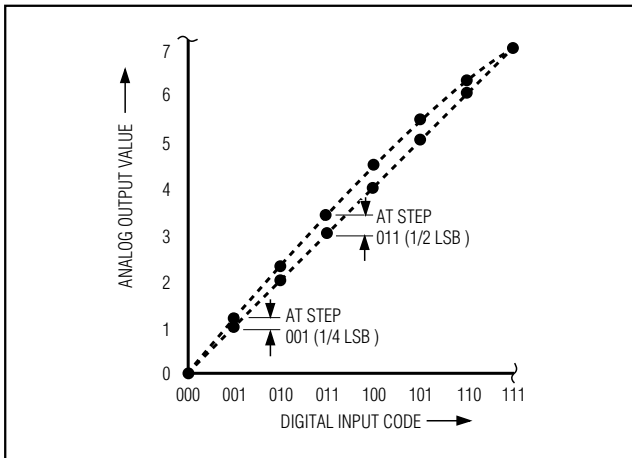

Figure 12a. Integral Nonlinearity

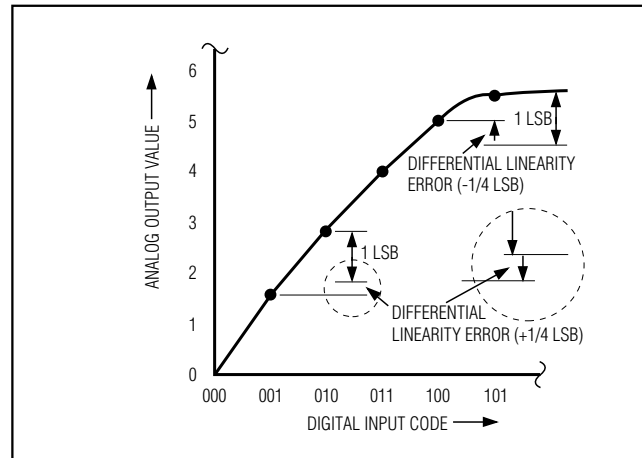

Figure 12b. Differential Nonlinearity

# Ultra-Low-Power, High Dynamic-Performance, 22MSPS Analog Front End

## Dynamic Parameter Definitions ADC and DAC Static Parameter Definitions

### Integral Nonlinearity (INL)

Integral nonlinearity is the deviation of the values on an actual transfer function from a straight line. This straight line can be either a best-straight-line fit or a line drawn between the end points of the transfer function, once offset and gain errors have been nullified. The static linearity parameters for the device are measured using the end-point method (DAC Figure 12a).

### Differential Nonlinearity (DNL)

Differential nonlinearity is the difference between an actual step width and the ideal value of 1 LSB. A DNL error specification of less than 1 LSB guarantees no missing codes (ADC) and a monotonic transfer function (ADC and DAC) (DAC Figure 12b).

### ADC Offset Error

Ideally, the midscale transition occurs at 0.5 LSB above midscale. The offset error is the amount of deviation between the measured transition point and the ideal transition point.

### DAC Offset Error

Offset error (Figure 12a) is the difference between the ideal and actual offset point. The offset point is the output value when the digital input is midscale. This error affects all codes by the same amount and usually can be compensated by trimming.

### ADC Gain Error

Ideally, the ADC full-scale transition occurs at 1.5 LSB below full scale. The gain error is the amount of deviation between the measured transition point and the ideal transition point with the offset error removed.

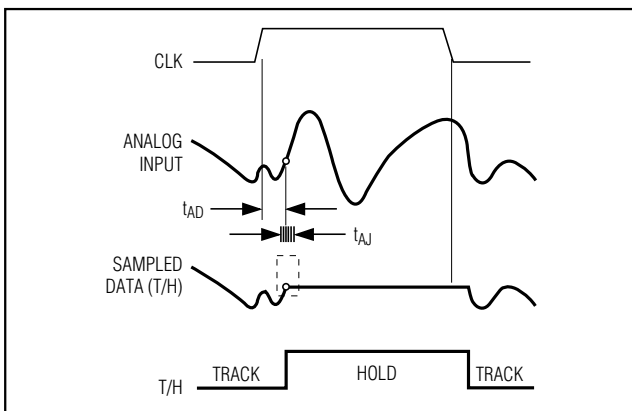

Figure 13. T/H Aperture Timing

## ADC Dynamic Parameter Definitions

### Aperture Jitter

Figure 13 depicts the aperture jitter ( $t_{AJ}$ ), which is the sample-to-sample variation in the aperture delay.

### Aperture Delay

Aperture delay ( $t_{AD}$ ) is the time defined between the rising edge of the sampling clock and the instant when an actual sample is taken (Figure 13).

### Signal-to-Noise Ratio (SNR)

For a waveform perfectly reconstructed from digital samples, the theoretical maximum SNR is the ratio of the full-scale analog input (RMS value) to the RMS quantization error (residual error) and results directly from the ADC's resolution (N bits):

$$\text{SNR}(\text{max}) = 6.02\text{dB} \times N + 1.76\text{dB} \text{ (in dB)}$$

In reality, there are other noise sources besides quantization noise: thermal noise, reference noise, clock jitter, etc. SNR is computed by taking the ratio of the RMS signal to the RMS noise. RMS noise includes all spectral components to the Nyquist frequency excluding the fundamental, the first five harmonics, and the DC offset.

### Signal-to-Noise Plus Distortion (SINAD)

SINAD is computed by taking the ratio of the RMS signal to the RMS noise. RMS noise includes all spectral components to the Nyquist frequency excluding the fundamental and the DC offset.

### Effective Number of Bits (ENOB)

ENOB specifies the dynamic performance of an ADC at a specific input frequency and sampling rate. An ideal ADC's error consists of quantization noise only. ENOB for a full-scale sinusoidal input waveform is computed from:

$$\text{ENOB} = (\text{SINAD} - 1.76) / 6.02$$

### Total Harmonic Distortion (THD)

THD is typically the ratio of the RMS sum of the first five harmonics of the input signal to the fundamental itself. This is expressed as:

$$\text{THD} = 20 \log \left[ \frac{\sqrt{(V_2^2 + V_3^2 + V_4^2 + V_5^2 + V_6^2)}}{V_1} \right]$$

where  $V_1$  is the fundamental amplitude and  $V_2$ – $V_6$  are the amplitudes of the 2nd- through 6th-order harmonics.

# Ultra-Low-Power, High Dynamic-Performance, 22MSPS Analog Front End

### Third Harmonic Distortion (HD3)

HD3 is defined as the ratio of the RMS value of the third harmonic component to the fundamental input signal.

### Spurious-Free Dynamic Range (SFDR)

SFDR is the ratio expressed in decibels of the RMS amplitude of the fundamental (maximum signal component) to the RMS value of the next-largest spurious component, excluding DC offset.

### Intermodulation Distortion (IMD)

IMD is the total power of the intermodulation products relative to the total input power when two tones,  $f_1$  and  $f_2$ , are present at the inputs. The intermodulation products are  $(f_1 \pm f_2)$ ,  $(2 \times f_1)$ ,  $(2 \times f_2)$ ,  $(2 \times f_1 \pm f_2)$ ,  $(2 \times f_2 \pm f_1)$ . The individual input tone levels are at -7dBFS.

### 3rd-Order Intermodulation (IM3)

IM3 is the power of the worst third-order intermodulation product relative to the input power of either input tone when two tones,  $f_1$  and  $f_2$ , are present at the inputs. The 3rd-order intermodulation products are  $(2 \times f_1 \pm f_2)$ ,  $(2 \times f_2 \pm f_1)$ . The individual input tone levels are at -7dBFS.

### Power-Supply Rejection

Power-supply rejection is defined as the shift in offset and gain error when the power supply is changed  $\pm 5\%$ .

### Small-Signal Bandwidth

A small -20dBFS analog input signal is applied to an ADC in such a way that the signal's slew rate does not limit the ADC's performance. The input frequency is then swept up to the point where the amplitude of the digitized conversion result has decreased by 3dB. Note that the T/H performance is usually the limiting factor for the small-signal input bandwidth.

### Full-Power Bandwidth

A large -0.5dBFS analog input signal is applied to an ADC, and the input frequency is swept up to the point where the amplitude of the digitized conversion result has decreased by 3dB. This point is defined as the full-power bandwidth frequency.

### DAC Dynamic Parameter Definitions Total Harmonic Distortion

THD is the ratio of the RMS sum of the output harmonics up to the Nyquist frequency divided by the fundamental:

$$THD = 20 \log \left[ \frac{\sqrt{V_2^2 + V_3^2 + \dots + V_n^2}}{V_1} \right]$$

where  $V_1$  is the fundamental amplitude and  $V_2$  through  $V_n$  are the amplitudes of the 2nd through nth harmonic up to the Nyquist frequency.

### Spurious-Free Dynamic Range

Spurious-free dynamic range (SFDR) is the ratio of RMS amplitude of the fundamental (maximum signal component) to the RMS value of the next-largest distortion component up to the Nyquist frequency excluding DC.

## Pin Configuration

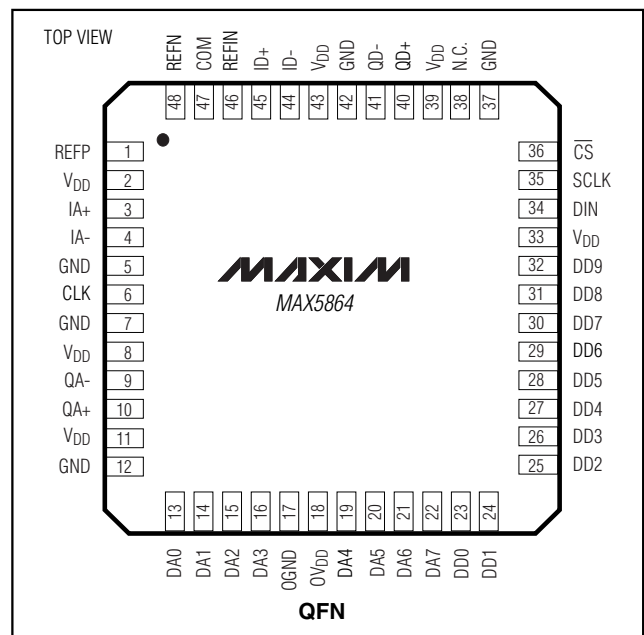

## Chip Information

TRANSISTOR COUNT: 16,765

PROCESS: CMOS

# Ultra-Low-Power, High Dynamic-Performance, 22MSPS Analog Front End

## Package Information

(The package drawing(s) in this data sheet may not reflect the most current specifications. For the latest package outline information, go to [www.maxim-ic.com/packages](http://www.maxim-ic.com/packages).)

**MAX5864**

32, 44, 48L QFN .EPS

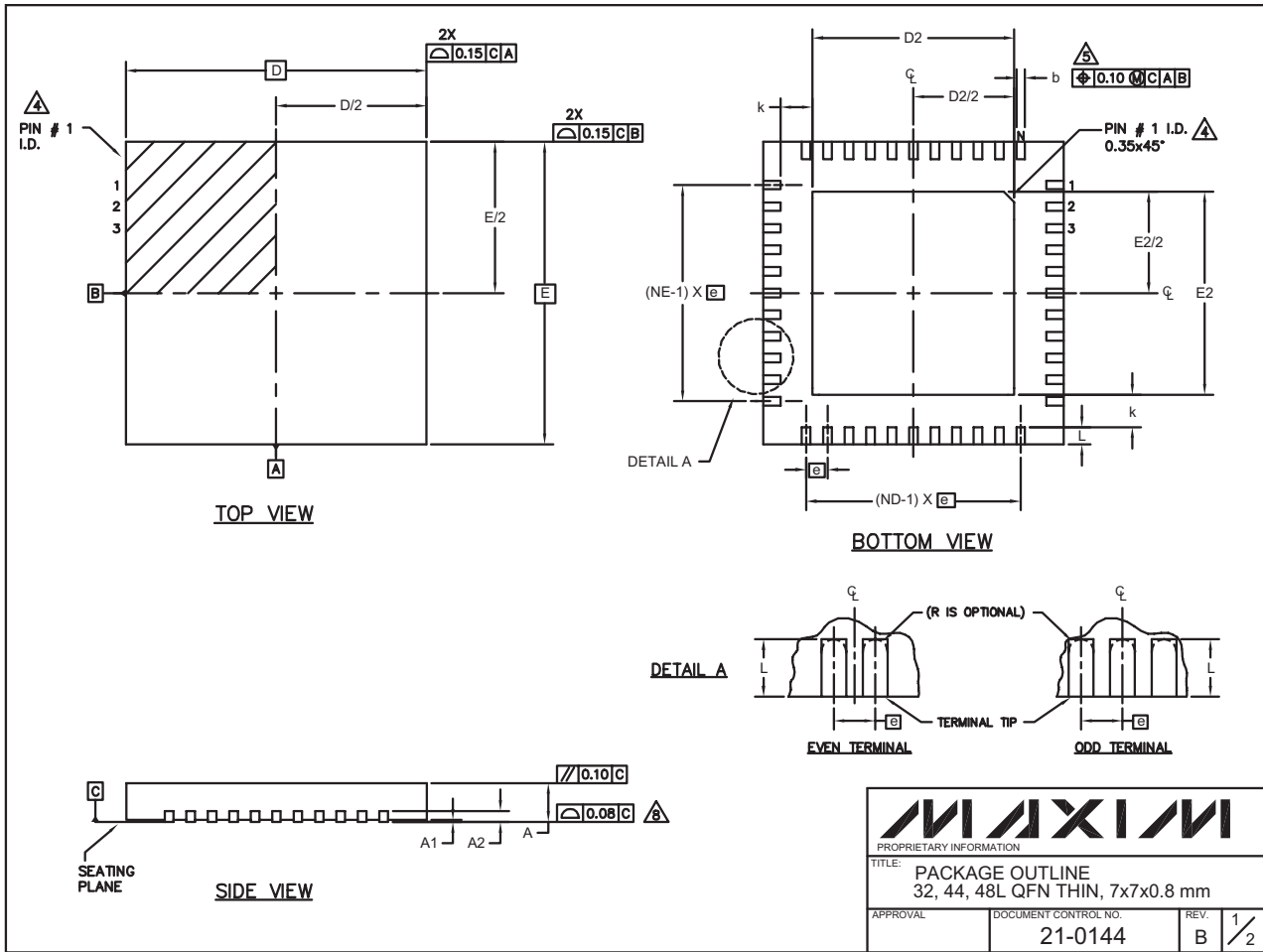

# Ultra-Low-Power, High-Dynamic-Performance, 22MSPS Analog Front End

## Package Information (continued)

(The package drawing(s) in this data sheet may not reflect the most current specifications. For the latest package outline information, go to [www.maxim-ic.com/packages](http://www.maxim-ic.com/packages).)

COMMON DIMENSIONS												
PKG	32L 7x7			44L 7x7			48L 7x7			CUSTOM PKG. (T4877-1) 48L 7x7		
SYMBOL	MIN.	NOM.	MAX.	MIN.	NOM.	MAX.	MIN.	NOM.	MAX.	MIN.	NOM.	MAX.
A	0.70	0.75	0.80	0.70	0.75	0.80	0.70	0.75	0.80	0.70	0.75	0.80
A1	0	0.02	0.05	0	0.02	0.05	0	0.02	0.05	0	0.02	0.05
A2	0.20 REF.			0.20 REF.			0.20 REF.			0.20 REF.		
b	0.25	0.30	0.35	0.20	0.25	0.30	0.20	0.25	0.30	0.20	0.25	0.30
D	6.90	7.00	7.10	6.90	7.00	7.10	6.90	7.00	7.10	6.90	7.00	7.10
E	6.90	7.00	7.10	6.90	7.00	7.10	6.90	7.00	7.10	6.90	7.00	7.10
e	0.65 BSC.			0.50 BSC.			0.50 BSC.			0.50 BSC.		
k	0.25	-	-	0.25	-	-	0.25	-	-	0.25	-	-
L	0.45	0.55	0.65	0.45	0.55	0.65	0.30	0.40	0.50	0.45	0.55	0.65
N	32			44			48			44		
ND	8			11			12			10		
NE	8			11			12			12		

  

EXPOSED PAD VARIATIONS								
PKG. CODES	DEPOPULATED LEADS	D2			E2			JEDEC MO220 REV. C
		MIN.	NOM.	MAX.	MIN.	NOM.	MAX.	
T3277-1	-	4.55	4.70	4.85	4.55	4.70	4.85	-
T4477-1	-	4.55	4.70	4.85	4.55	4.70	4.85	WKKD-1
T4877-1**	13, 24, 37, 48	4.20	4.30	4.40	4.20	4.30	4.40	-
T4877-2	-	5.45	5.60	5.83	5.45	5.60	5.83	WKKD-2

\*\* NOTE: T4877-1 IS A CUSTOM 48L PKG. WITH 4 LEADS DEPOPULATED. TOTAL NUMBER OF LEADS ARE 44.

NOTES:

- DIMENSIONING & TOLERANCING CONFORM TO ASME Y14.5M-1994.
- ALL DIMENSIONS ARE IN MILLIMETERS. ANGLES ARE IN DEGREES.
- N IS THE TOTAL NUMBER OF TERMINALS.
- THE TERMINAL #1 IDENTIFIER AND TERMINAL NUMBERING CONVENTION SHALL CONFORM TO JESD 95-1 SPP-012. DETAILS OF TERMINAL #1 IDENTIFIER ARE OPTIONAL, BUT MUST BE LOCATED WITHIN THE ZONE INDICATED. THE TERMINAL #1 IDENTIFIER MAY BE EITHER A MOLD OR MARKED FEATURE.
- DIMENSION b APPLIES TO METALLIZED TERMINAL AND IS MEASURED BETWEEN 0.25 mm AND 0.30 mm FROM TERMINAL TIP.
- ND AND NE REFER TO THE NUMBER OF TERMINALS ON EACH D AND E SIDE RESPECTIVELY.
- DEPOPULATION IS POSSIBLE IN A SYMMETRICAL FASHION.
- COPLANARITY APPLIES TO THE EXPOSED HEAT SINK SLUG AS WELL AS THE TERMINALS.
- DRAWING CONFORMS TO JEDEC MO220.
- WARPAGE SHALL NOT EXCEED 0.10 mm.



TITLE: PACKAGE OUTLINE  
32, 44, 48L QFN THIN, 7x7x0.8 mm

APPROVAL	DOCUMENT CONTROL NO. 21-0144	REV. B	2/2
----------	---------------------------------	-----------	-----

Maxim cannot assume responsibility for use of any circuitry other than circuitry entirely embodied in a Maxim product. No circuit patent licenses are implied. Maxim reserves the right to change the circuitry and specifications without notice at any time.

26 \_\_\_\_\_ **Maxim Integrated Products, 120 San Gabriel Drive, Sunnyvale, CA 94086 408-737-7600**

## Looking for pricing, stock, or lifecycle information?

Click below to explore more details on WIN SOURCE:

 [View MAX5864ETM+ on WIN SOURCE](#)

 [Maxim Integrated Information](#)

## Optimize Your Supply Chain with WIN SOURCE Solutions

-  Global Sourcing Solution
-  Obsolete Management
-  Cost Control Management
-  Shortage Management
-  Alternative Solution
-  Excess Inventory Management