



**THE DATASHEET OF
CY2CP1504ZXIT**



1:4 LVCMOS to LVPECL Fanout Buffer with Selectable Clock Input

Features

- Select one of two low-voltage complementary metal oxide semiconductor (LVCMOS) inputs to distribute to four low-voltage positive emitter-coupled logic (LVPECL) output pairs
- 30-ps maximum output-to-output skew
- 480-ps maximum propagation delay
- 0.15-ps maximum additive RMS phase jitter at 156.25 MHz (12-kHz to 20-MHz offset)
- Up to 250 MHz operation
- Synchronous clock enable function
- 20-Pin thin shrunk small outline package (TSSOP) package
- 2.5-V or 3.3-V operating voltage ^[1]
- Commercial and industrial operating temperature range

Functional Description

The CY2CP1504 is an ultra-low noise, low-skew, low-propagation delay 1:4 LVCMOS to LVPECL fanout buffer targeted to meet the requirements of high-speed clock distribution applications. The CY2CP1504 can select between two separate LVCMOS input clocks using the IN_SEL pin. The synchronous clock enable function ensures glitch-free output transitions during enable and disable periods. The device has a fully differential internal architecture that is optimized to achieve low additive jitter and low skew at operating frequencies of up to 250 MHz.

For a complete list of related documentation, [click here](#).

Logic Block Diagram

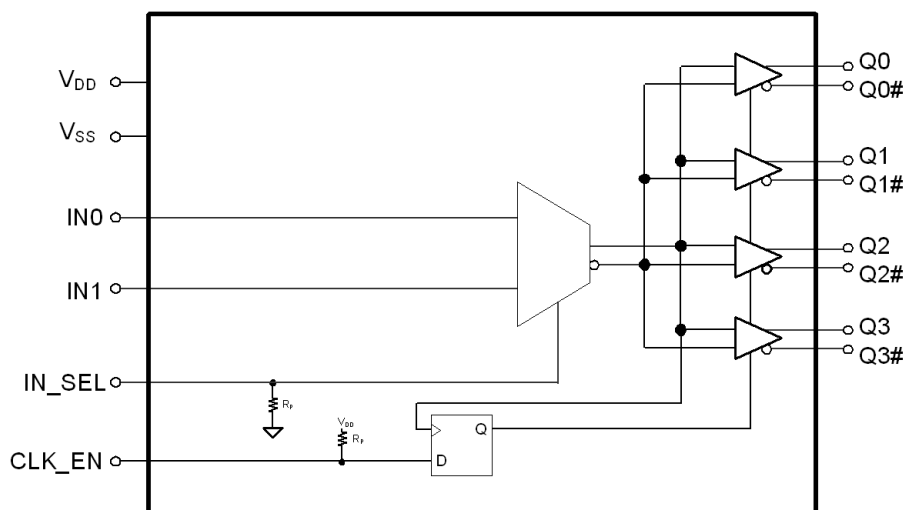

Note

1. Input AC-coupling capacitors are required for voltage-translation applications.

Contents

Pin Configurations	3	Acronyms	11
Pin Definitions	3	Document Conventions	11
Absolute Maximum Ratings	4	Units of Measure	11
Operating Conditions	4	Document History Page	12
DC Electrical Specifications	5	Sales, Solutions, and Legal Information	14
Thermal Resistance	5	Worldwide Sales and Design Support	14
AC Electrical Specifications	6	Products	14
Ordering Information	9	PSoC@Solutions	14
Ordering Code Definitions	9	Cypress Developer Community	14
Package Diagram	10	Technical Support	14

Pin Configurations

Figure 1. 20-pin TSSOP Package pinout

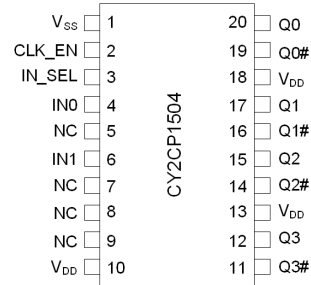

Pin Definitions

Pin No.	Pin Name	Pin Type	Description
1	V _{SS}	Power	Ground
2	CLK_EN	Input	Synchronous clock enable. LVCMOS/low-voltage transistor-transistor logic (LVTTL). When CLK_EN = Low, Q(0:3) outputs are held low and Q(0:3)# outputs are held high
3	IN_SEL	Input	Input clock select pin. LVCMOS/LVTTL; When IN_SEL = Low, input IN0 is active When IN_SEL = High, input IN1 is active
4	IN0	Input	LVCMOS input clock. Active when IN_SEL = Low
5, 7, 8, 9	NC		No connection
6	IN1	Input	LVCMOS input clock. Active when IN_SEL = High
10, 13, 18	V _{DD}	Power	Power supply
11, 14, 16, 19	Q(0:3)#	Output	LVPECL complementary output clocks
12, 15, 17, 20	Q(0:3)	Output	LVPECL output clocks

Absolute Maximum Ratings

Parameter	Description	Condition	Min	Max	Unit
V_{DD}	Supply voltage	Nonfunctional	-0.5	4.6	V
$V_{IN}^{[2]}$	Input voltage, relative to V_{SS}	Nonfunctional	-0.5	lesser of 4.0 or $V_{DD} + 0.4$	V
$V_{OUT}^{[2]}$	DC output or I/O voltage, relative to V_{SS}	Nonfunctional	-0.5	lesser of 4.0 or $V_{DD} + 0.4$	V
T_S	Storage temperature	Nonfunctional	-55	150	°C
ESD_{HBM}	Electrostatic discharge (ESD) protection (Human body model)	JEDEC STD 22-A114-B	2000	-	V
L_U	Latch up		Meets or exceeds JEDEC Spec JESD78B IC latch up test		
UL-94	Flammability rating	At 1/8 in	V-0		
MSL	Moisture sensitivity level		3		

Operating Conditions

Parameter	Description	Condition	Min	Max	Unit
V_{DD}	Supply voltage	2.5 V supply	2.375	2.625	V
		3.3 V supply	3.135	3.465	V
T_A	Ambient operating temperature	Commercial	0	70	°C
		Industrial	-40	85	°C
t_{PU}	Power ramp time	Power-up time for V_{DD} to reach minimum specified voltage (power ramp must be monotonic)	0.05	500	ms

Note

2. The voltage on any I/O pin cannot exceed the power pin during power up. Power supply sequencing is not required.

DC Electrical Specifications

($V_{DD} = 3.3\text{ V} \pm 5\%$ or $2.5\text{ V} \pm 5\%$; $T_A = 0\text{ }^\circ\text{C}$ to $70\text{ }^\circ\text{C}$ (Commercial) or $-40\text{ }^\circ\text{C}$ to $85\text{ }^\circ\text{C}$ (Industrial))

Parameter	Description	Condition	Min	Max	Unit
I_{DD}	Operating supply current	All LVPECL outputs floating (internal I_{DD})	–	61	mA
V_{IH1}	Input high voltage, All inputs	$V_{DD} = 3.3\text{ V}$	2.0	$V_{DD} + 0.3$	V
V_{IL1}	Input low voltage, All inputs	$V_{DD} = 3.3\text{ V}$	–0.3	0.8	V
V_{IH2}	Input high voltage, All inputs	$V_{DD} = 2.5\text{ V}$	1.7	$V_{DD} + 0.3$	V
V_{IL2}	Input low voltage, All inputs	$V_{DD} = 2.5\text{ V}$	–0.3	0.7	V
I_{IH}	Input high current, All inputs	Input = V_{DD} ^[3]	–	150	μA
I_{IL}	Input low current, All inputs	Input = V_{SS} ^[3]	–150	–	μA
V_{OH}	LVPECL output high voltage	Terminated with $50\ \Omega$ to $V_{DD} - 2.0$ ^[4]	$V_{DD} - 1.20$	$V_{DD} - 0.70$	V
V_{OL}	LVPECL output low voltage	Terminated with $50\ \Omega$ to $V_{DD} - 2.0$ ^[4]	$V_{DD} - 2.0$	$V_{DD} - 1.63$	V
R_P	Internal pull-up/pull-down resistance	CLK_EN has pull-up only IN_SEL has pull-down only	60	165	$\text{k}\Omega$
C_{IN}	Input capacitance	Measured at 10 MHz; per pin	–	3	pF

Thermal Resistance

Parameter ^[5]	Description	Test Conditions	20-pin TSSOP	Unit
θ_{JA}	Thermal resistance (junction to ambient)	Test conditions follow standard test methods and procedures for measuring thermal impedance, in accordance with EIA/JESD51.	80	$^\circ\text{C}/\text{W}$
θ_{JC}	Thermal resistance (junction to case)		16	$^\circ\text{C}/\text{W}$

Notes

3. Positive current flows into the input pin, negative current flows out of the input pin.
4. Refer to Figure 2 on page 7.
5. These parameters are guaranteed by design and are not tested.

AC Electrical Specifications

($V_{DD} = 3.3\text{ V} \pm 5\%$ or $2.5\text{ V} \pm 5\%$; $T_A = 0\text{ }^\circ\text{C}$ to $70\text{ }^\circ\text{C}$ (Commercial) or $-40\text{ }^\circ\text{C}$ to $85\text{ }^\circ\text{C}$ (Industrial))

Parameter	Description	Condition	Min	Typ	Max	Unit
F_{IN}	Input frequency		DC	–	250	MHz
F_{OUT}	Output frequency	$F_{OUT} = F_{IN}$	DC	–	250	MHz
V_{PP}	LVPECL differential output voltage peak- to-peak, single-ended. Terminated with $50\ \Omega$ to $V_{DD} - 2.0$ [4]	$F_{out} = \text{DC to } 150\text{ MHz}$	600	–	–	mV
		$F_{out} = >150\text{ MHz to } 250\text{ MHz}$	400	–	–	mV
t_{PD} [6]	Propagation delay input to output pair	Input rise/fall time $< 1.5\text{ ns}$ (20% to 80%)	–	–	480	ps
t_{ODC} [7]	Output duty cycle	Rail-to-rail input swing, 50% input DTCY measured at $V_{dd}/2$	45	–	55	%
t_{SK1} [8]	Output-to-output skew	Any output to any output, with same load conditions at DUT	–	–	30	ps
$t_{SK1 D}$ [8]	Device-to-device output skew	Any output to any output between two or more devices. Devices must have the same input and have the same output load.	–	–	150	ps
PN_{ADD}	Additive RMS phase noise 156.25-MHz Input Rise/fall time $< 150\text{ ps}$ (20% to 80%) $V_{ID} > 400\text{ mV}$	Offset = 1 kHz	–	–	–120	dBc/Hz
		Offset = 10 kHz	–	–	–130	dBc/Hz
		Offset = 100 kHz	–	–	–135	dBc/Hz
		Offset = 1 MHz	–	–	–150	dBc/Hz
		Offset = 10 MHz	–	–	–150	dBc/Hz
		Offset = 20 MHz	–	–	–150	dBc/Hz
t_{JIT} [9]	Additive RMS phase jitter (Random)	156.25 MHz sinewave, 12 kHz to 20 MHz offset; input swing = 2.2V , $V_{bias} = V_{DD}/2$	–	–	0.15	ps
t_R, t_F [10]	Output rise/fall time	50% duty cycle at input, 20% to 80% of full swing (V_{OL} to V_{OH}) Input rise/fall time $< 1.5\text{ ns}$ (20% to 80%)	–	–	300	ps
t_{SOD}	Time from clock edge to outputs disabled	Synchronous clock enable (CLK_EN) switched Low	–	–	700	ps
t_{SOE}	Time from clock edge to outputs enabled	Synchronous clock enable (CLK_EN) switched high	–	–	700	ps

Notes

6. Refer to Figure 3 on page 7.
7. Refer to Figure 4 on page 7.
8. Refer to Figure 5 on page 7.
9. Refer to Figure 6 on page 8.
10. Refer to Figure 7 on page 8.

Figure 2. Output Differential Voltage

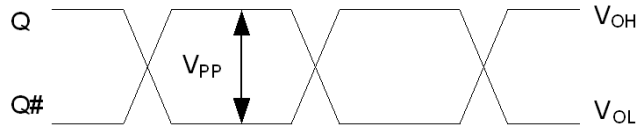

Figure 3. Input to Any Output Pair Propagation Delay

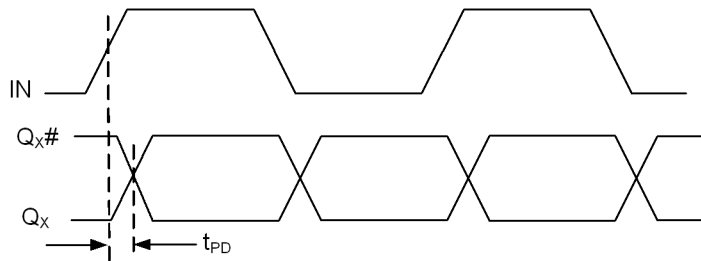

Figure 4. Output Duty Cycle

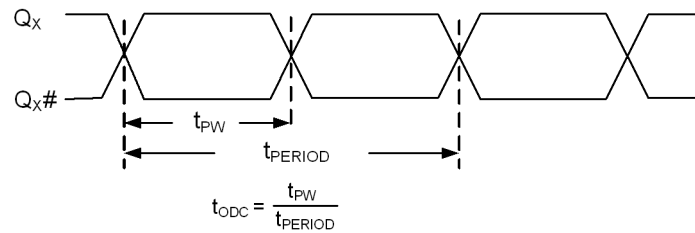

Figure 5. Output-to-Output and Device-to-Device Skew

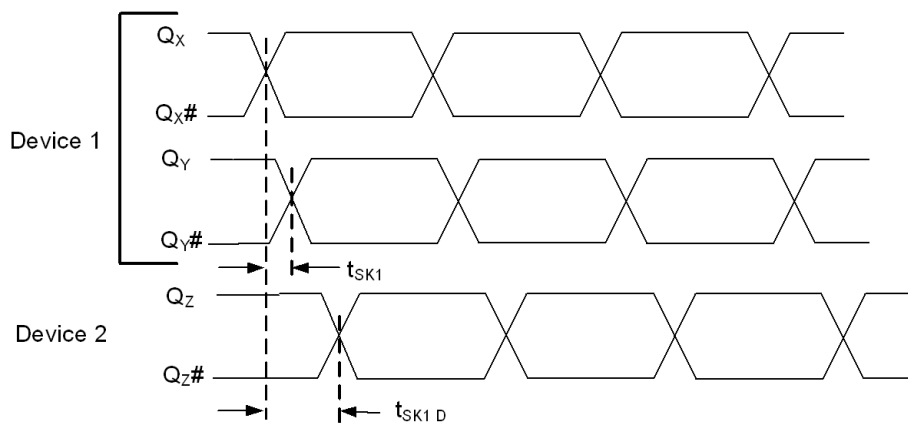

Figure 6. RMS Phase Jitter

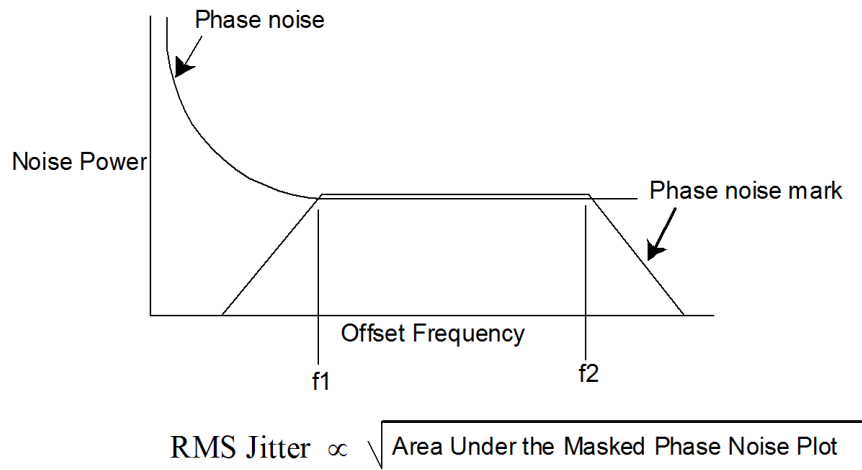

Figure 7. Output Rise/Fall Time

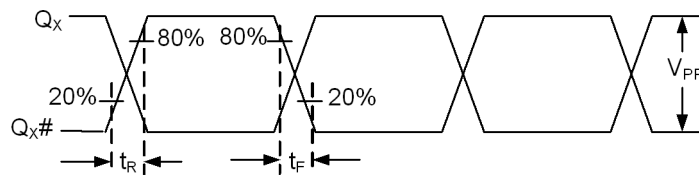
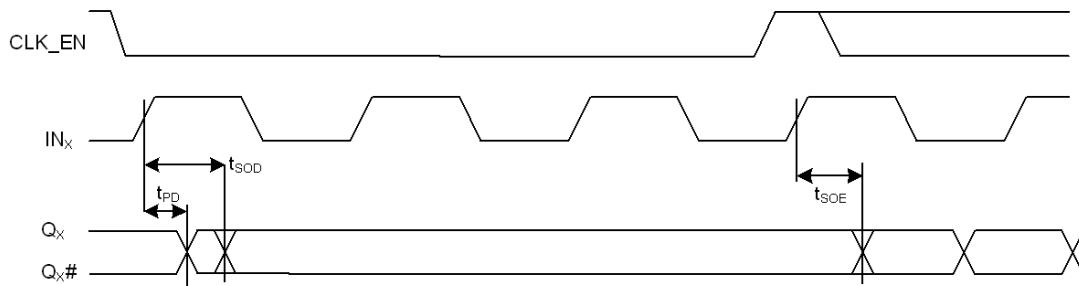

Figure 8. Synchronous Clock Enable Timing



Ordering Information

Part Number	Type	Production Flow
Pb-free		
CY2CP1504ZXC	20-pin TSSOP	Commercial, 0 °C to 70 °C
CY2CP1504ZXCT	20-pin TSSOP – Tape and Reel	Commercial, 0 °C to 70 °C
CY2CP1504ZXI	20-pin TSSOP	Industrial, –40 °C to 85 °C
CY2CP1504ZXIT	20-pin TSSOP – Tape and Reel	Industrial, –40 °C to 85 °C

Ordering Code Definitions

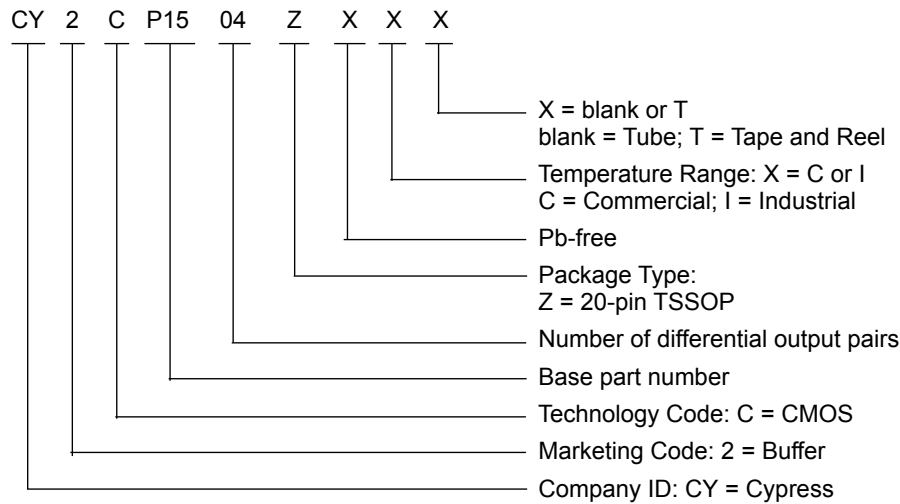

Package Diagram

Figure 9. 20-pin TSSOP (4.40 mm Body) Z20.173/ZZ20.173 Package Outline, 51-85118

20 Lead TSSOP 4.40 MM BODY

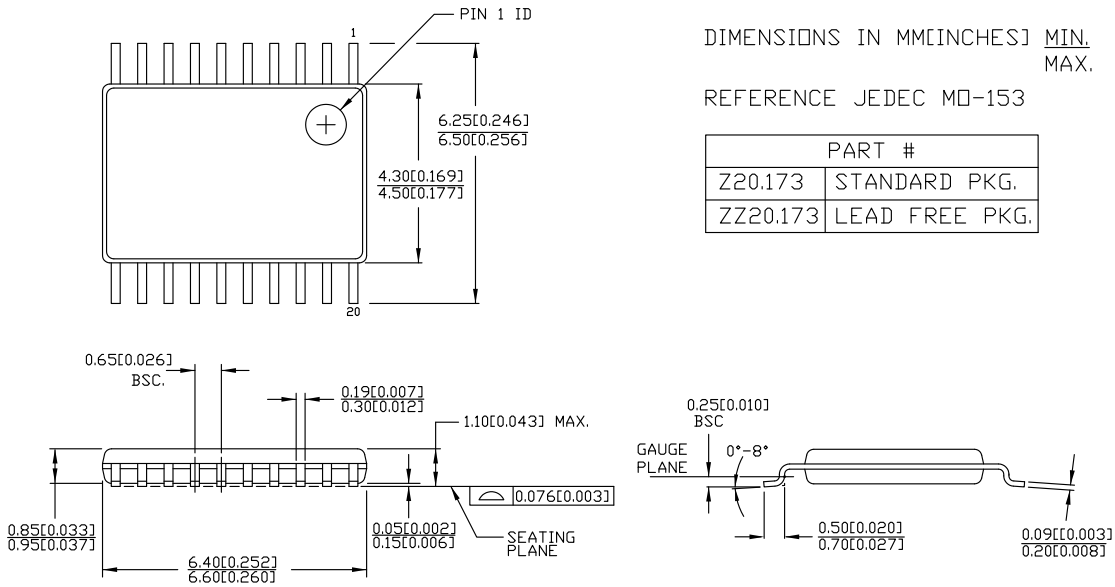

51-85118 *E

Acronyms

Table 1. Acronyms Used in this Document

Acronym	Description
ESD	electrostatic discharge
HBM	human body model
JEDEC	joint electron devices engineering council
LVDS	low-voltage differential signal
LVC MOS	low-voltage complementary metal oxide semiconductor
LVPECL	low-voltage positive emitter-coupled logic
LVTTTL	low-voltage transistor-transistor logic
RMS	root mean square
TSSOP	thin shrunk small outline package

Document Conventions

Units of Measure

Table 2. Units of Measure

Symbol	Unit of Measure
°C	degree Celsius
dBc	decibels relative to the carrier
GHz	gigahertz
Hz	hertz
kΩ	kilohm
μA	microampere
μF	microfarad
μs	microsecond
mA	milliampere
ms	millisecond
mV	millivolt
MHz	megahertz
ns	nanosecond
Ω	ohm
pF	picofarad
ps	picosecond
V	volt
W	watt

Document History Page

Document Title: CY2CP1504, 1:4 LVCMOS to LVPECL Fanout Buffer with Selectable Clock Input				
Document Number: 001-56313				
Revision	ECN	Orig. of Change	Submission Date	Description of Change
**	2782891	CXQ	10/09/09	New data sheet
*A	2838916	CXQ	05/01/2010	<p>Changed status from “ADVANCE” to “PRELIMINARY”.</p> <p>Changed from 0.34 ps to 0.25 ps maximum additive jitter in “Features” on page 1 and in t_{JIT} in the AC Electrical Specs table on page 5.</p> <p>Added t_{PU} spec to the Operating Conditions table on page 3.</p> <p>Changed max I_{DD} spec in the DC Electrical Specs table on page 4 from 60 mA to 61 mA.</p> <p>Changed V_{OH} in the DC Electrical Specs table on page 4: minimum from $V_{DD} - 1.15V$ to $V_{DD} - 1.20V$; maximum from $V_{DD} - 0.75V$ to $V_{DD} - 0.70V$.</p> <p>Removed V_{OD} spec from the DC Electrical Specs table on page 4.</p> <p>Added R_P spec in the DC Electrical Specs table on page 4. Min = 60 kΩ, Max = 140 kΩ.</p> <p>Added a measurement definition for C_{IN} in the DC Electrical Specs table on page 4.</p> <p>Added V_{PP} spec to the AC Electrical Specs table on page 5. V_{PP} min = 600 mV for DC - 150 MHz and min = 400 mV for 150 MHz to 250 MHz.</p> <p>Changed letter case and some names of all the timing parameters in the AC Electrical Specs table on page 5 to be consistent with EROS.</p> <p>Lowered all additive phase noise mask specs by 3 dB in the AC Electrical Specs table on page 5.</p> <p>Added condition to t_R and t_F specs in the AC Electrical specs table on page 5 that input rise/fall time must be less than 1.5 ns (20% to 80%).</p> <p>Changed letter case and some names of all the timing parameters in Figures 2, 3, 4, 5 and 7, to be consistent with EROS.</p>
*B	3011766	CXQ	08/20/2010	<p>Changed from 0.25 ps to 0.15 ps maximum additive jitter in “Features” on page 1 and in t_{JIT} in the AC Electrical Specs table on page 6.</p> <p>Added note 2 to describe I_{IH} and I_{IL} specs.</p> <p>Removed reference to data distribution from “Functional Description”.</p> <p>Updated phase noise specs for 1 k/10 k/100 k/1 M/10 M/20 MHz offset to -120/-130/-135/-150/-150/-150dBc/Hz, respectively, in the AC Electrical Specs table.</p> <p>Updated package diagram.</p> <p>Added Acronyms and Ordering Code Definition.</p>
*C	3017258	CXQ	08/27/2010	Corrected Output Rise/Fall time diagram.
*D	3100234	CXQ	11/18/2010	<p>Changed V_{IN} and V_{OUT} specs from 4.0V to “lesser of 4.0 or $V_{DD} + 0.4$”</p> <p>Removed 200mA min LU spec, replaced with “Meets or exceeds JEDEC Spec JESD78B IC Latchup Test”</p> <p>Changed C_{IN} condition to “Measured at 10 MHz”.</p> <p>Removed t_R and t_F input specs from AC specs table.</p> <p>Changed t_{ODC} from 48/52% to 45/55%, changed condition to “Rail-to-rail input swing, 50% input duty cycle measured at $V_{DD}/2$”.</p> <p>Changed phase jitter condition to “156.25 MHz sinewave, 12 kHz to 20 MHz offset; input swing = 2.2V, $V_{bias} = V_{DD}/2$”</p> <p>Removed t_S and t_H specs from AC specs table.</p>
*E	3137726	CXQ	01/13/2011	<p>Removed “Preliminary” status heading.</p> <p>Removed resistors from IN0/IN1 in Logic Block Diagram.</p> <p>Added Figure 8 to describe T_{SOE} and T_{SOD}.</p>
*F	3182321	CXQ	02/25/11	Post to external web.
*G	3208968	CXQ	03/29/2011	Changed R_P max from 140 k Ω to 165 k Ω and updated R_P in Logic Block Diagram .

Document History Page (continued)

Document Title: CY2CP1504, 1:4 LVCMOS to LVPECL Fanout Buffer with Selectable Clock Input Document Number: 001-56313				
Revision	ECN	Orig. of Change	Submission Date	Description of Change
*H	3878020	PURU	01/21/2013	Updated Package Diagram : spec 51-85118 – Changed revision from *C to *D. Updated to new template.
*I	4587249	PURU	12/03/2014	Updated Functional Description : Added “For a complete list of related documentation, click here. ” at the end. Updated Package Diagram : spec 51-85118 – Changed revision from *D to *E.
*J	5267558	PSR	05/13/2016	Added Thermal Resistance . Updated to new template.

Sales, Solutions, and Legal Information

Worldwide Sales and Design Support

Cypress maintains a worldwide network of offices, solution centers, manufacturer's representatives, and distributors. To find the office closest to you, visit us at [Cypress Locations](#).

Products

ARM® Cortex® Microcontrollers	cypress.com/arm
Automotive	cypress.com/automotive
Clocks & Buffers	cypress.com/clocks
Interface	cypress.com/interface
Lighting & Power Control	cypress.com/powerpsoc
Memory	cypress.com/memory
PSoC	cypress.com/psoc
Touch Sensing	cypress.com/touch
USB Controllers	cypress.com/usb
Wireless/RF	cypress.com/wireless

PSoC® Solutions

[PSoC 1](#) | [PSoC 3](#) | [PSoC 4](#) | [PSoC 5LP](#)

Cypress Developer Community

[Forums](#) | [Projects](#) | [Video](#) | [Blogs](#) | [Training](#) | [Components](#)

Technical Support

cypress.com/support



© Cypress Semiconductor Corporation, 2009-2016. This document is the property of Cypress Semiconductor Corporation and its subsidiaries, including Spansion LLC ("Cypress"). This document, including any software or firmware included or referenced in this document ("Software"), is owned by Cypress under the intellectual property laws and treaties of the United States and other countries worldwide. Cypress reserves all rights under such laws and treaties and does not, except as specifically stated in this paragraph, grant any license under its patents, copyrights, trademarks, or other intellectual property rights. If the Software is not accompanied by a license agreement and you do not otherwise have a written agreement with Cypress governing the use of the Software, then Cypress hereby grants you a personal, non-exclusive, nontransferable license (without the right to sublicense) (1) under its copyright rights in the Software (a) for Software provided in source code form, to modify and reproduce the Software solely for use with Cypress hardware products, only internally within your organization, and (b) to distribute the Software in binary code form externally to end users (either directly or indirectly through resellers and distributors), solely for use on Cypress hardware product units, and (2) under those claims of Cypress's patents that are infringed by the Software (as provided by Cypress, unmodified) to make, use, distribute, and import the Software solely for use with Cypress hardware products. Any other use, reproduction, modification, translation, or compilation of the Software is prohibited.

TO THE EXTENT PERMITTED BY APPLICABLE LAW, CYPRESS MAKES NO WARRANTY OF ANY KIND, EXPRESS OR IMPLIED, WITH REGARD TO THIS DOCUMENT OR ANY SOFTWARE OR ACCOMPANYING HARDWARE, INCLUDING, BUT NOT LIMITED TO, THE IMPLIED WARRANTIES OF MERCHANTABILITY AND FITNESS FOR A PARTICULAR PURPOSE. To the extent permitted by applicable law, Cypress reserves the right to make changes to this document without further notice. Cypress does not assume any liability arising out of the application or use of any product or circuit described in this document. Any information provided in this document, including any sample design information or programming code, is provided only for reference purposes. It is the responsibility of the user of this document to properly design, program, and test the functionality and safety of any application made of this information and any resulting product. Cypress products are not designed, intended, or authorized for use as critical components in systems designed or intended for the operation of weapons, weapons systems, nuclear installations, life-support devices or systems, other medical devices or systems (including resuscitation equipment and surgical implants), pollution control or hazardous substances management, or other uses where the failure of the device or system could cause personal injury, death, or property damage ("Unintended Uses"). A critical component is any component of a device or system whose failure to perform can be reasonably expected to cause the failure of the device or system, or to affect its safety or effectiveness. Cypress is not liable, in whole or in part, and you shall and hereby do release Cypress from any claim, damage, or other liability arising from or related to all Unintended Uses of Cypress products. You shall indemnify and hold Cypress harmless from and against all claims, costs, damages, and other liabilities, including claims for personal injury or death, arising from or related to any Unintended Uses of Cypress products.







Cypress, the Cypress logo, Spansion, the Spansion logo, and combinations thereof, PSoC, CapSense, EZ-USB, F-RAM, and Traveo are trademarks or registered trademarks of Cypress in the United States and other countries. For a more complete list of Cypress trademarks, visit cypress.com. Other names and brands may be claimed as property of their respective owners.

Looking for pricing, stock, or lifecycle information?

Click below to explore more details on WIN SOURCE:

-  [View CY2CP1504ZXIT on WIN SOURCE](#)
-  [Cypress Semiconductor Corp Information](#)

Optimize Your Supply Chain with WIN SOURCE Solutions

-  Global Sourcing Solution
-  Obsolete Management
-  Cost Control Management
-  Shortage Management
-  Alternative Solution
-  Excess Inventory Management