



THE DATASHEET OF
SI9987CY-T1-E3



Buffered H-Bridge Driver with Integrate MOSFET

DESCRIPTION

The Si9987 is an integrated, buffered H-bridge with TTL compatible inputs and the capability of delivering a continuous 1 A at $V_{DD} = 5\text{ V}$ (room temperature) at switching rates up to 500 kHz. Internal logic prevents the upper and lower outputs of either half-bridge from being turned on simultaneously. Unique input codes allow both outputs to be forced low (for braking) or forced to a high impedance level.

The Si9987 is available in an 8-pin SOIC package, specified to operate over a voltage range of 3.8 V to 13.2 V, and the commercial temperature range of 0 °C to 70 °C (C suffix) and - 40 °C to 85 °C (D suffix). The Si9987 is available in lead free.

FEATURES

- 1 A H-bridge
- 500 kHz switching rate
- Shoot-through limited
- TTL compatible inputs
- 3.8 V to 13.2 V operating range
- Surface mount packaging 1 A H-bridge

APPLICATIONS

- VCM driver
- Brushed motor driver
- Stepper motor driver
- Power converter
- Optical disk drives
- Power supplies
- High performance servo

FUNCTIONAL BLOCK DIAGRAM, PIN CONFIGURATION AND TRUTH TABLE

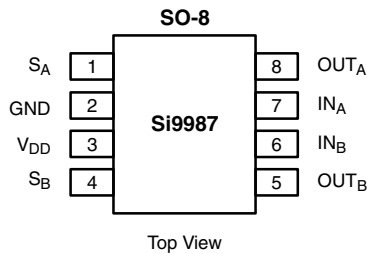

TRUTH TABLE			
IN _A	IN _B	OUT _A	OUT _B
1	0	1	0
0	1	0	1
0	0	0	0
1	1	HiZ	HiZ

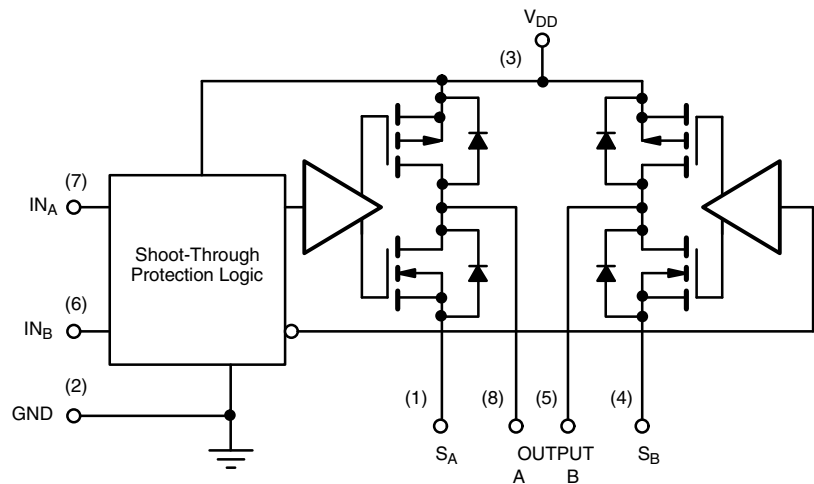

ORDERING INFORMATION		
Part Number	Temperature Range	Package
Si9987CY-T1	0 °C to 70 °C	Tape and reel
Si9987DY-T1	- 40 °C to 85 °C	
Si9987CY-T1-E3	0 °C to 70 °C	Lead free Tape and reel
Si9987DY-T1-E3	- 40 °C to 85 °C	
Si9987CY	0 °C to 70 °C	Bulk (tubes)
Si9987DY	- 40 °C to 85 °C	

ABSOLUTE MAXIMUM RATINGS ^a			
Parameter		Limit	Unit
Voltage on any Pin with Respect to Ground		- 0.3 V to $V_{DD} + 0.3$ V	V
Voltage on Pins 5, 8 with Respect to Ground		- 1 V to $V_{DD} + 1$ V	
Voltage on Pins 1, 4		- 0.3 V to GND + 1 V	
Maximum V_{DD}		15	V
Peak Output Current		1.5	A
Storage Temperature		- 65 to 150	°C
Maximum Junction Temperature (T_J)		150	
Power Dissipation ^b		1	W
θ_{JA}		100	°C/W
Continuous I_{OUT} Current ($T_J = 135$ °C) ^c	$T_A = 25$ °C	± 1.02	A
	$T_A = 70$ °C	± 0.75	
	$T_A = 85$ °C	± 0.65	
Operating Temperature Range	Si9987CY	0 to 70	°C
	Si9987DY	- 45 to 85	

Notes:

a. Device mounted with all leads soldered or welded to PC board.

b. Derate 10 mW/°C above 25 °C.

c. $T_J = T_A + (P_D \times \theta_{JA})$, P_D = power dissipation.

Stresses beyond those listed under "Absolute Maximum Ratings" may cause permanent damage to the device. These are stress ratings only, and functional operation of the device at these or any other conditions beyond those indicated in the operational sections of the specifications is not implied. Exposure to absolute maximum ratings for extended periods may affect device reliability.

RECOMMENDED OPERATING RANGE			
Parameter		Limit	Unit
V_{DD}		3.8 to 13.2	V
Maximum Junction Temperature (T_J)		135	°C

SPECIFICATIONS						
Parameter	Symbol	Test Conditions Unless Specified $V_{DD} = 3.8$ V to 13.2 V S_A at GND, S_B at GND	Limits			Unit
			Min ^a	Typ ^b	Max ^a	
Input						
Input Voltage High	V_{INH}		2			V
Input Voltage Low	V_{INL}				1	
Input Current with Input Voltage High	I_{INH}	$V_{IN} = 2$ V			1	µA
Input Current with Input Voltage Low	I_{INL}	$V_{IN} = 0$ V	- 1			
Output						
Output Voltage High ^c	V_{OUTH}	$I_{OUT} = - 1$ mA	$V_{DD} = 10.8$ V	10.40	10.56	V
			$V_{DD} = 4.5$ V	4.00	4.20	
		$I_{OUT} = - 500$ mA	$V_{DD} = 10.8$ V	10.60	10.68	
			$V_{DD} = 4.5$ V	4.25	4.35	
		$I_{OUT} = - 300$ mA, $V_{DD} = 3.8$ V	3.63	3.70		
Output Voltage Low ^c	V_{OUTL}	$I_{OUT} = 1$ mA	$V_{DD} = 10.8$ V		0.24	0.40
			$V_{DD} = 4.5$ V		0.30	0.50
		$I_{OUT} = 500$ mA	$V_{DD} = 10.8$ V		0.12	0.20
			$V_{DD} = 4.5$ V		0.15	0.25
				$I_{OUT} = 300$ mA, $V_{DD} = 3.8$ V		0.10
Output Leakage Current Low	I_{OLL}	$I_{NA} = I_{NB} \geq 2$ V, $V_{OUT} = V_{DD} = 13.2$ V		0	10	µA
Output Leakage Current High	I_{OLH}	$V_{OUT} = 0$, $V_{DD} = 13.2$ V	- 10	0		
Output V Clamp High	V_{CLH}	$I_{NA} = I_{NB} \geq 2$ V	$I_{OUT} = 100$ mA		$V_{DD} + 0.7$	$V_{DD} + 0.9$
Output V Clamp Low	V_{CLL}		$I_{OUT} = - 100$ mA	- 0.9	- 0.7	
Supply						
V_{DD} Supply Current	I_{DD}	$I_N = 100$ kHz, $V_{DD} = 5.5$ V		1.8	2.5	mA
		$I_{NA} = I_{NB} = 4.5$ V, $V_{DD} = 5.5$ V		75	125	
Dynamic						
Propagation Delay Time	T_{PLH}	$V_{DD} = 5$ V		300		nS
	T_{PHL}			100		

Notes:

a. The algebraic convention whereby the most negative value is a minimum and the most positive a maximum, is used in this data sheet.

b. Typical values are for DESIGN AID ONLY, not guaranteed nor subject to production testing.

c. Maximum value measured at $T_J = 135$ °C. Typical value measured at $T_J = T_A = 25$ °C (pulse width ≤ 300 µsec, duty cycle ≤ 2 %).

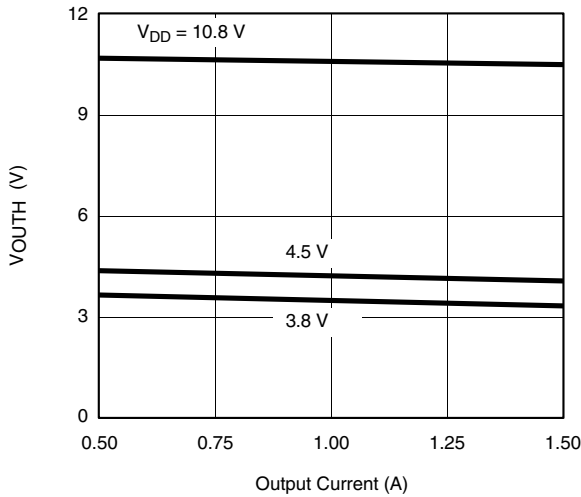
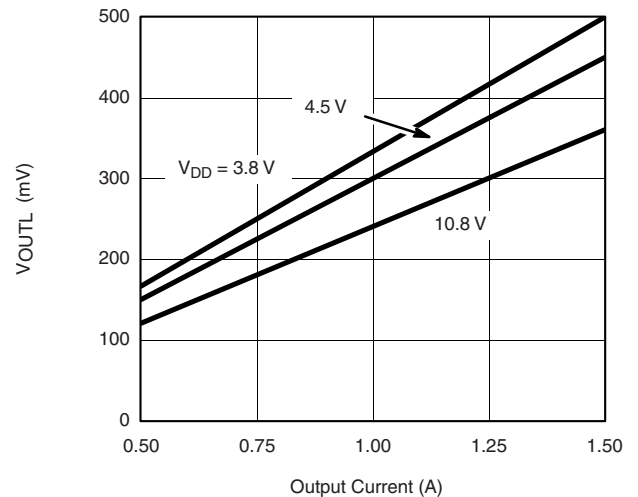
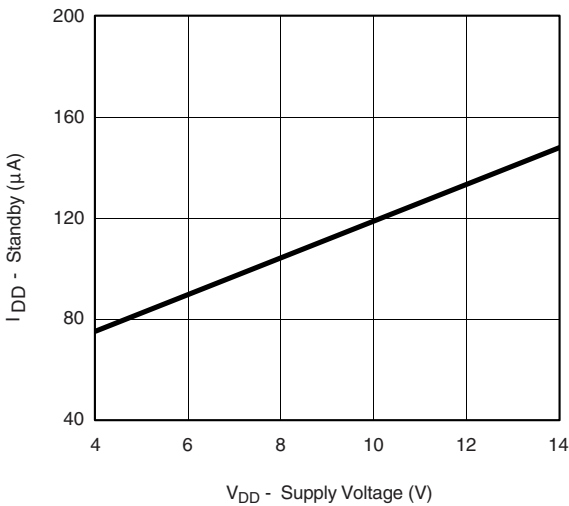
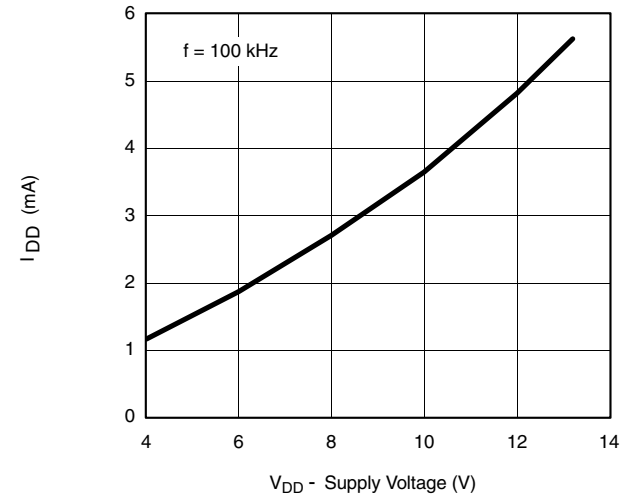
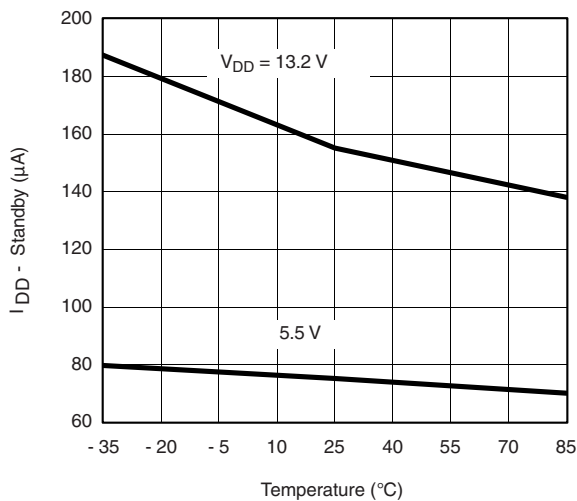
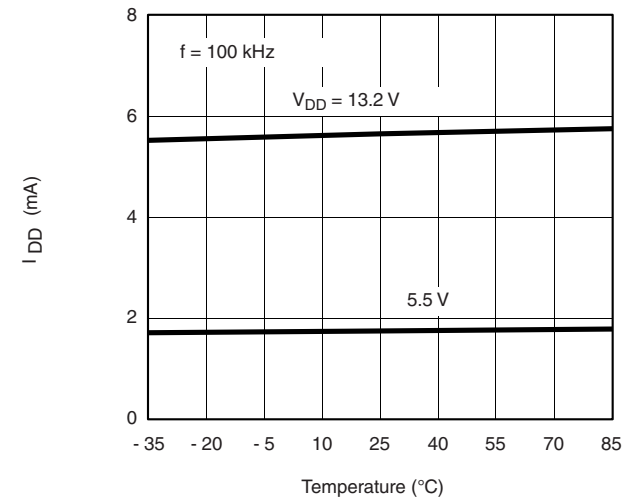
TYPICAL CHARACTERISTICS (25 °C unless otherwise noted)

Output High Voltage vs. Output Current

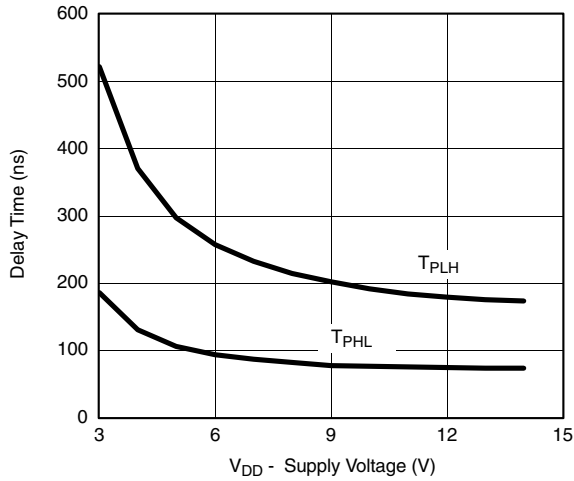
Output Low Voltage vs. Output Current

Supply Current vs. Supply Voltage

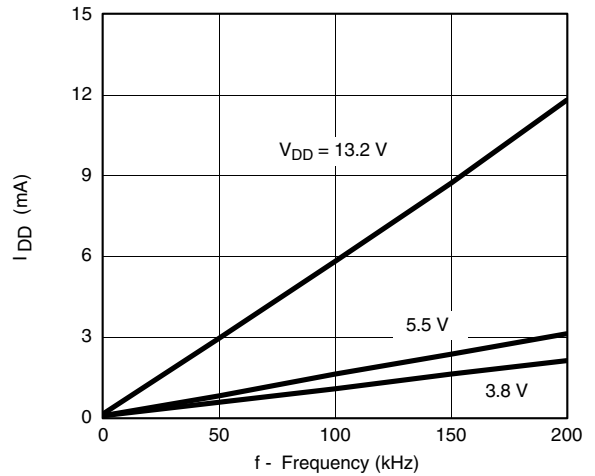
Supply Current vs. Supply Voltage

Supply Current vs. Temperature

Supply Current vs. Temperature

TYPICAL CHARACTERISTICS (25 °C unless otherwise noted)



Propagation Time vs. Supply Voltage



Supply Current vs. Frequency

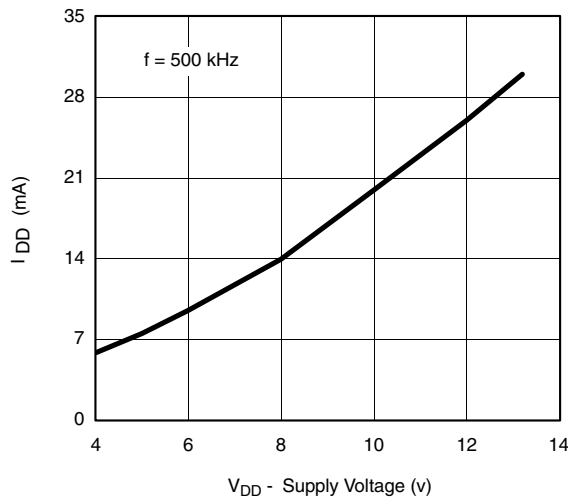

Supply Current vs. Supply Voltage

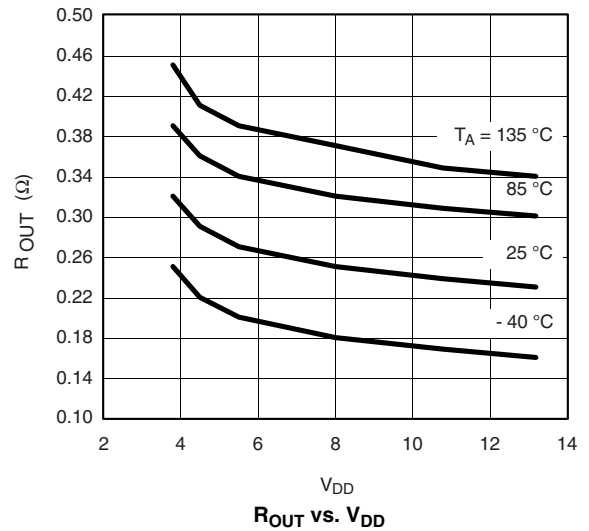

ROUT vs. VDD

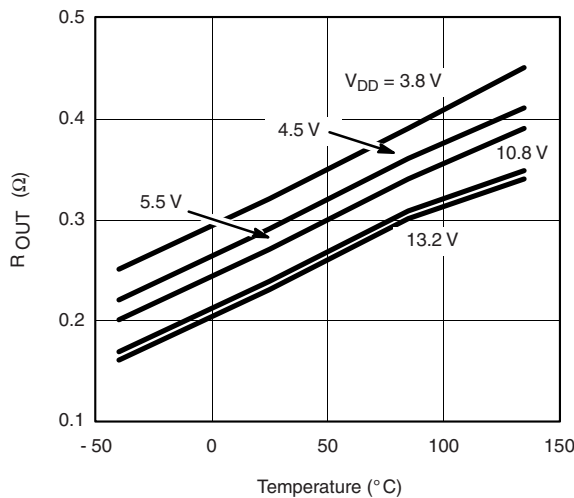

ROUT vs. Junction Temperature (T_J)

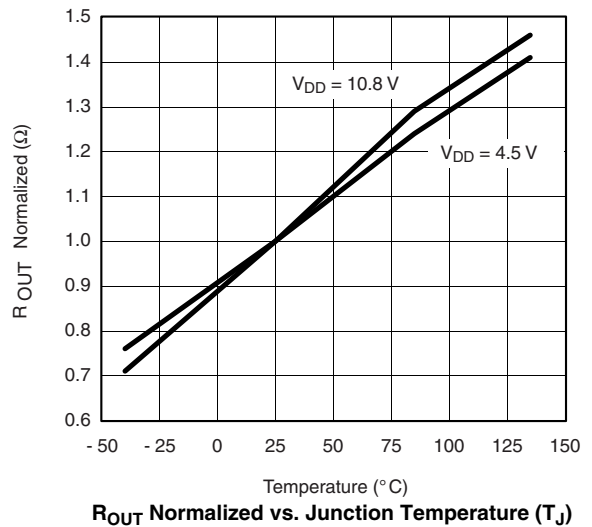

ROUT Normalized vs. Junction Temperature (T_J)

Vishay Siliconix maintains worldwide manufacturing capability. Products may be manufactured at one of several qualified locations. Reliability data for Silicon Technology and Package Reliability represent a composite of all qualified locations. For related documents such as package/tape drawings, part marking, and reliability data, see www.vishay.com/ppg?70864.

SOIC (NARROW): 8-LEAD

JEDEC Part Number: MS-012

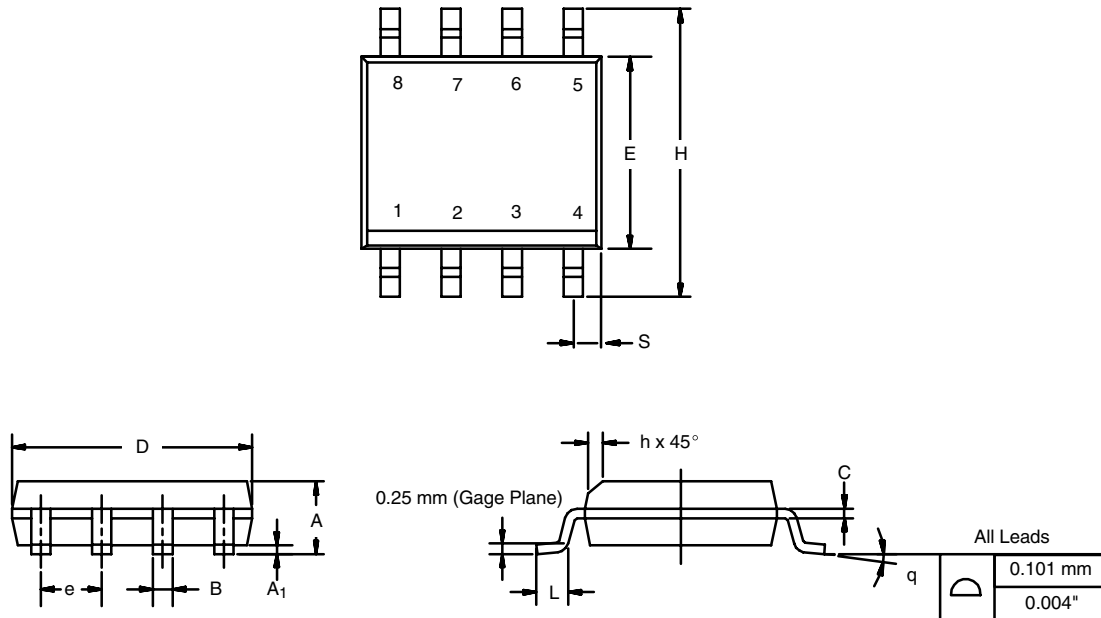

DIM	MILLIMETERS		INCHES	
	Min	Max	Min	Max
A	1.35	1.75	0.053	0.069
A ₁	0.10	0.20	0.004	0.008
B	0.35	0.51	0.014	0.020
C	0.19	0.25	0.0075	0.010
D	4.80	5.00	0.189	0.196
E	3.80	4.00	0.150	0.157
e	1.27 BSC		0.050 BSC	
H	5.80	6.20	0.228	0.244
h	0.25	0.50	0.010	0.020
L	0.50	0.93	0.020	0.037
q	0°	8°	0°	8°
S	0.44	0.64	0.018	0.026
ECN: C-06527-Rev. I, 11-Sep-06 DWG: 5498				



Disclaimer

ALL PRODUCT, PRODUCT SPECIFICATIONS AND DATA ARE SUBJECT TO CHANGE WITHOUT NOTICE TO IMPROVE RELIABILITY, FUNCTION OR DESIGN OR OTHERWISE.

Vishay Intertechnology, Inc., its affiliates, agents, and employees, and all persons acting on its or their behalf (collectively, "Vishay"), disclaim any and all liability for any errors, inaccuracies or incompleteness contained in any datasheet or in any other disclosure relating to any product.

Vishay makes no warranty, representation or guarantee regarding the suitability of the products for any particular purpose or the continuing production of any product. To the maximum extent permitted by applicable law, Vishay disclaims (i) any and all liability arising out of the application or use of any product, (ii) any and all liability, including without limitation special, consequential or incidental damages, and (iii) any and all implied warranties, including warranties of fitness for particular purpose, non-infringement and merchantability.

Statements regarding the suitability of products for certain types of applications are based on Vishay's knowledge of typical requirements that are often placed on Vishay products in generic applications. Such statements are not binding statements about the suitability of products for a particular application. It is the customer's responsibility to validate that a particular product with the properties described in the product specification is suitable for use in a particular application. Parameters provided in datasheets and / or specifications may vary in different applications and performance may vary over time. All operating parameters, including typical parameters, must be validated for each customer application by the customer's technical experts. Product specifications do not expand or otherwise modify Vishay's terms and conditions of purchase, including but not limited to the warranty expressed therein.

Except as expressly indicated in writing, Vishay products are not designed for use in medical, life-saving, or life-sustaining applications or for any other application in which the failure of the Vishay product could result in personal injury or death. Customers using or selling Vishay products not expressly indicated for use in such applications do so at their own risk. Please contact authorized Vishay personnel to obtain written terms and conditions regarding products designed for such applications.

No license, express or implied, by estoppel or otherwise, to any intellectual property rights is granted by this document or by any conduct of Vishay. Product names and markings noted herein may be trademarks of their respective owners.

Looking for pricing, stock, or lifecycle information?

Click below to explore more details on WIN SOURCE:

 [View S19987CY-T1-E3 on WIN SOURCE](#)

 [Vishay Information](#)

Optimize Your Supply Chain with WIN SOURCE Solutions

-  Global Sourcing Solution
-  Obsolete Management
-  Cost Control Management
-  Shortage Management
-  Alternative Solution
-  Excess Inventory Management