



**THE DATASHEET OF  
LM4923LQ/NOPB**



# LM4923 Boomer® Audio Power Amplifier Series 1.1 Watt Fully Differential Audio Power Amplifier With Shutdown Select

Check for Samples: [LM4923](#), [LM4923LQBD](#)

## FEATURES

- Fully Differential Amplification
- Available in Space-saving WQFN Package
- Ultra Low Current Shutdown Mode
- Can Drive Capacitive Loads up to 100pF
- Improved Pop & Click Circuitry Eliminates Noises During Turn-on and Turn-off Transitions
- 2.4 - 5.5V Operation
- No Output Coupling Capacitors, Snubber Networks or Bootstrap Capacitors Required

## APPLICATIONS

- Mobile Phones
- PDAs
- Portable Electronic Devices

## KEY SPECIFICATIONS

- Improved PSRR at 217Hz 85dB(typ)
- Power Output at 5.0V @ 1% THD+N 1.1W(typ)
- Power Output at 3.3V @ 1% THD+N 400mW(typ)
- Shutdown Current 0.1µA(typ)

## Connection Diagrams

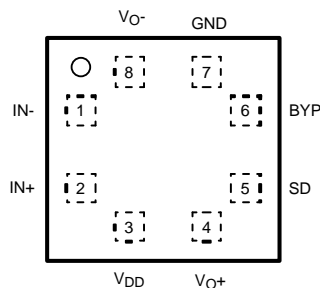

**Figure 1. NGP Package, Top View**  
See Package Number NGP0008A

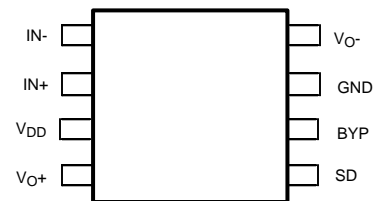

**Figure 2. 8 Pin VSSOP Package, Top View**  
See Package Number DGK0008A

## DESCRIPTION

The LM4923 is a fully differential audio power amplifier primarily designed for demanding applications in mobile phones and other portable communication device applications. It is capable of delivering 1.1 watt of continuous average power to an 8Ω BTL load with less than 1% distortion (THD+N) from a 5V<sub>DC</sub> power supply.

Boomer audio power amplifiers were designed specifically to provide high quality output power with a minimal amount of external components. The LM4923 does not require output coupling capacitors or bootstrap capacitors, and therefore is ideally suited for mobile phone and other low voltage applications where minimal power consumption is a primary requirement.

The LM4923 features a low-power consumption shutdown mode. To facilitate this, Shutdown may be enabled by logic low. Additionally, the LM4923 features an internal thermal shutdown protection mechanism.

The LM4923 contains advanced pop & click circuitry which eliminates noises which would otherwise occur during turn-on and turn-off transitions.



Please be aware that an important notice concerning availability, standard warranty, and use in critical applications of Texas Instruments semiconductor products and disclaimers thereto appears at the end of this data sheet.

All trademarks are the property of their respective owners.

## Typical Application

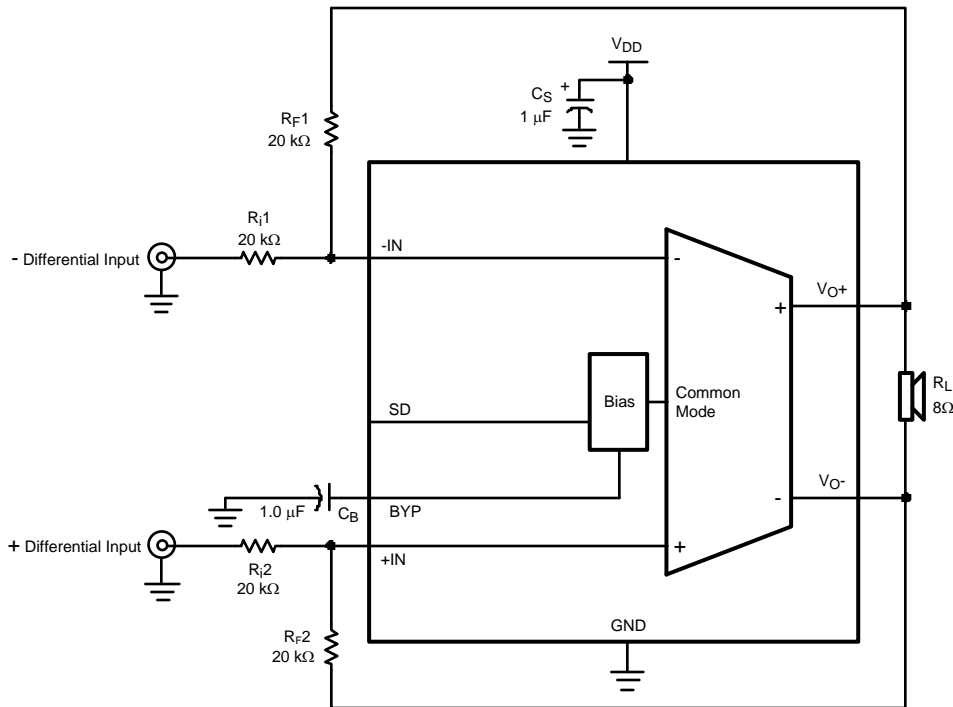

**Figure 3. Typical Audio Amplifier Application Circuit**



These devices have limited built-in ESD protection. The leads should be shorted together or the device placed in conductive foam during storage or handling to prevent electrostatic damage to the MOS gates.

### Absolute Maximum Ratings<sup>(1)(2)</sup>

Supply Voltage		6.0V
Storage Temperature		-65°C to +150°C
Input Voltage		-0.3V to $V_{DD} + 0.3V$
Power Dissipation <sup>(3)</sup>		Internally Limited
ESD Susceptibility <sup>(4)</sup>		2000V
ESD Susceptibility <sup>(5)</sup>		200V
Junction Temperature		150°C
Thermal Resistance	$\theta_{JA}$ (WQFN)	140°C/W
	$\theta_{JA}$ (DGK)	210°C/W
	$\theta_{JC}$ (DGK)	56°C/W
Soldering Information		
See AN-1187 ( <a href="#">SNOA401</a> )		

- (1) *Absolute Maximum Ratings* indicate limits beyond which damage to the device may occur. *Operating Ratings* indicate conditions for which the device is functional, but do not ensure specific performance limits. *Electrical Characteristics* state DC and AC electrical specifications under particular test conditions which ensure specific performance limits. This assumes that the device is within the Operating Ratings. Specifications are not ensured for parameters where no limit is given, however, the typical value is a good indication of device performance.
- (2) If Military/Aerospace specified devices are required, please contact the Texas Instruments Sales Office/ Distributors for availability and specifications.
- (3) The maximum power dissipation must be derated at elevated temperatures and is dictated by  $T_{JMAX}$ ,  $\theta_{JA}$ , and the ambient temperature  $T_A$ . The maximum allowable power dissipation is  $P_{DMAX} = (T_{JMAX} - T_A) / \theta_{JA}$  or the number given in Absolute Maximum Ratings, whichever is lower. For the LM4923, see power derating curve for additional information.
- (4) Human body model, 100pF discharged through a 1.5kΩ resistor.
- (5) Machine Model, 220pF – 240pF discharged through all pins.

**Operating Ratings**

Temperature Range	
$T_{MIN} \leq T_A \leq T_{MAX}$	$-40^{\circ}\text{C} \leq T_A \leq 85^{\circ}\text{C}$
Supply Voltage	$2.4\text{V} \leq V_{DD} \leq 5.5\text{V}$

## Electrical Characteristics $V_{DD} = 5V^{(1)(2)}$

The following specifications apply for  $V_{DD} = 5V$ ,  $A_V = 1$ , and  $8\Omega$  load unless otherwise specified. Limits apply for  $T_A = 25^\circ C$ .

Symbol	Parameter	Conditions	LM4923		Units (Limits)
			Typical <sup>(3)</sup>	Limit <sup>(4)</sup>	
$I_{DD}$	Quiescent Power Supply Current	$V_{IN} = 0V$ , no load $V_{IN} = 0V$ , $R_L = 8\Omega$	4 4	9 9	mA (max)
$I_{SD}$	Shutdown Current	$V_{SHUTDOWN} = GND$	0.1	1	$\mu A$ (max)
$P_o$	Output Power	THD = 1% (max); $f = 1$ kHz			
		LM4923, $R_L = 8\Omega$	1.1	1	
THD+N	Total Harmonic Distortion+Noise	$P_o = 0.4$ Wrms; $f = 1$ kHz	0.02		%
PSRR	Power Supply Rejection Ratio	$V_{ripple} = 200mV$ sine p-p			
		$f = 217Hz^{(5)}$	85	73	
		$f = 1kHz^{(5)}$	85	73	
CMRR	Common_Mode Rejection Ratio	$f = 217Hz$ , $V_{CM} = 200mV_{pp}$	50		dB
$V_{OS}$	Output Offset	$V_{IN} = 0V$	4		mV
$V_{SDIH}$	Shutdown Voltage Input High		0.9		V
$V_{SDIL}$	Shutdown Voltage Input Low		0.7		V

- (1) All voltages are measured with respect to the ground pin, unless otherwise specified.
- (2) *Absolute Maximum Ratings* indicate limits beyond which damage to the device may occur. *Operating Ratings* indicate conditions for which the device is functional, but do not ensure specific performance limits. *Electrical Characteristics* state DC and AC electrical specifications under particular test conditions which ensure specific performance limits. This assumes that the device is within the Operating Ratings. Specifications are not ensured for parameters where no limit is given, however, the typical value is a good indication of device performance.
- (3) Typicals are measured at  $25^\circ C$  and represent the parametric norm.
- (4) Datasheet min/max specification limits are specified by design, test, or statistical analysis.
- (5)  $10\Omega$  terminated input.

**Electrical Characteristics  $V_{DD} = 3V^{(1)}$  (2)**

 The following specifications apply for  $V_{DD} = 3V$ ,  $A_V = 1$ , and  $8\Omega$  load unless otherwise specified. Limits apply for  $T_A = 25^\circ C$ .

Symbol	Parameter	Conditions	LM4923		Units (Limits)
			Typical <sup>(3)</sup>	Limit <sup>(4)</sup>	
$I_{DD}$	Quiescent Power Supply Current	$V_{IN} = 0V$ , no load $V_{IN} = 0V$ , $R_L = 8\Omega$	3 3	5.5 5.5	mA (max)
$I_{SD}$	Shutdown Current	$V_{SHUTDOWN} = GND$	0.1	1	$\mu A$ (max)
$P_o$	Output Power	THD = 1% (max); $f = 1kHz$ LM4923, $R_L = 8\Omega$	0.375		W
THD+N	Total Harmonic Distortion+Noise	$P_o = 0.25W_{rms}$ ; $f = 1kHz$	0.02		%
PSRR	Power Supply Rejection Ratio	$V_{ripple} = 200mV$ sine p-p			
		$f = 217Hz$ <sup>(5)</sup>	85		
		$f = 1kHz$ <sup>(5)</sup>	85	73	
CMRR	Common-Mode Rejection Ratio	$f = 217Hz$ $V_{CM} = 200mV_{pp}$	50		dB
$V_{OS}$	Output Offset	$V_{IN} = 0V$	4		mV
$V_{SDIH}$	Shutdown Voltage Input High		0.8		V
$V_{SDIL}$	Shutdown Voltage Input Low		0.6		V

- (1) All voltages are measured with respect to the ground pin, unless otherwise specified.
- (2) *Absolute Maximum Ratings* indicate limits beyond which damage to the device may occur. *Operating Ratings* indicate conditions for which the device is functional, but do not ensure specific performance limits. *Electrical Characteristics* state DC and AC electrical specifications under particular test conditions which ensure specific performance limits. This assumes that the device is within the Operating Ratings. Specifications are not ensured for parameters where no limit is given, however, the typical value is a good indication of device performance.
- (3) Typical values are measured at  $25^\circ C$  and represent the parametric norm.
- (4) Datasheet min/max specification limits are specified by design, test, or statistical analysis.
- (5)  $10\Omega$  terminated input.

## EXTERNAL COMPONENTS DESCRIPTION

(Figure 3)

Components		Functional Description
1.	$R_i$	Inverting input resistance which sets the closed-loop gain in conjunction with $R_f$ .
2.	$R_f$	Feedback resistance which sets the closed-loop gain in conjunction with $R_i$ .
3.	$C_S$	Supply bypass capacitor which provides power supply filtering. Refer to the <a href="#">Power Supply Bypassing</a> section for information concerning proper placement and selection of the supply bypass capacitor.
4.	$C_B$	Bypass pin capacitor which provides half-supply filtering. Refer to the section, <a href="#">Proper Selection of External Components</a> , for information concerning proper placement and selection of $C_B$ .

Typical Performance Characteristics

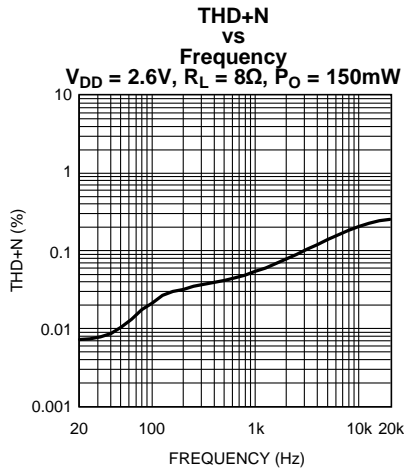

Figure 4.

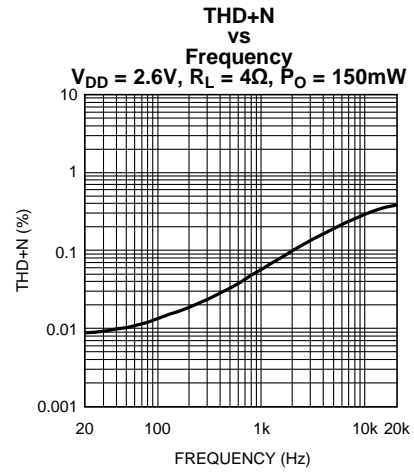

Figure 5.

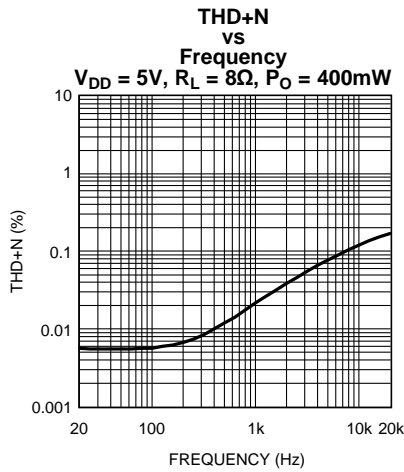

Figure 6.

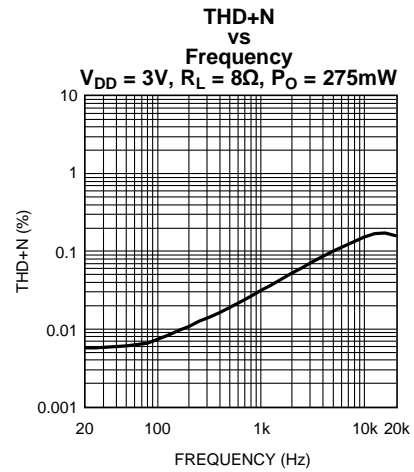

Figure 7.

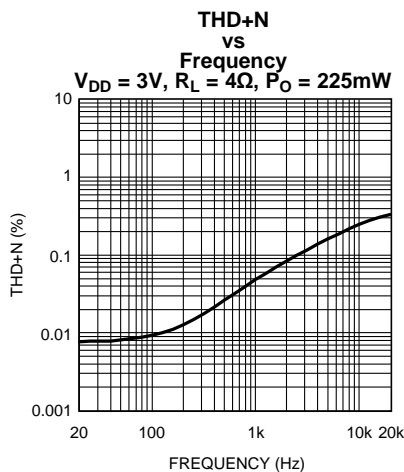

Figure 8.

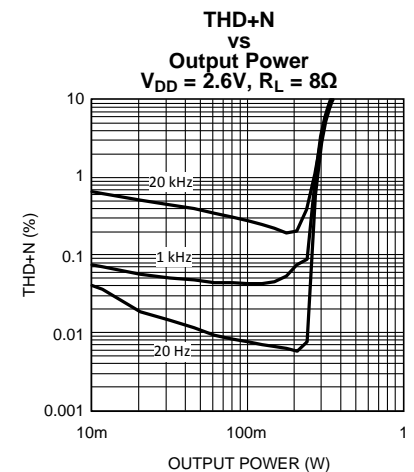

Figure 9.

Typical Performance Characteristics (continued)

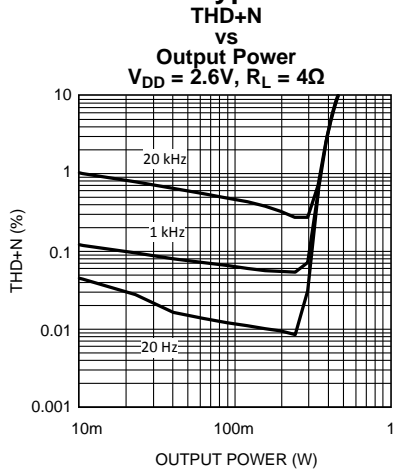

Figure 10.

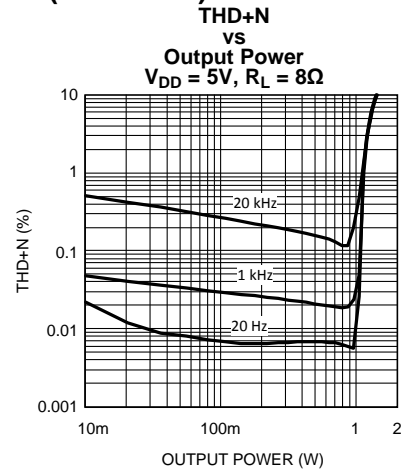

Figure 11.

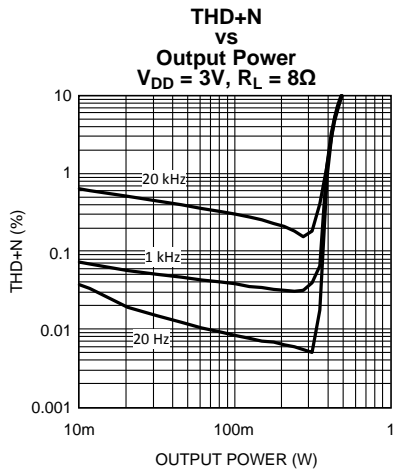

Figure 12.

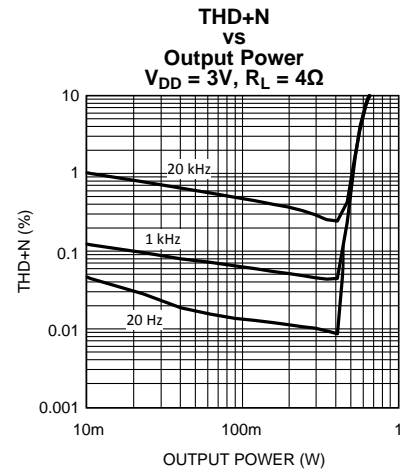

Figure 13.

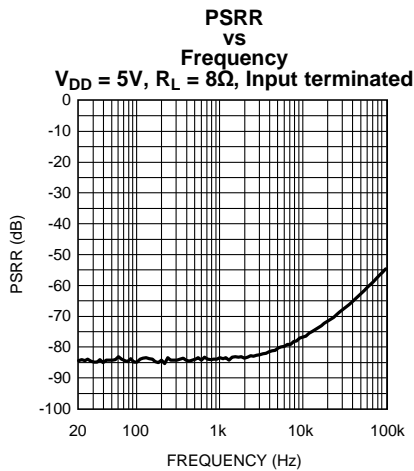

Figure 14.

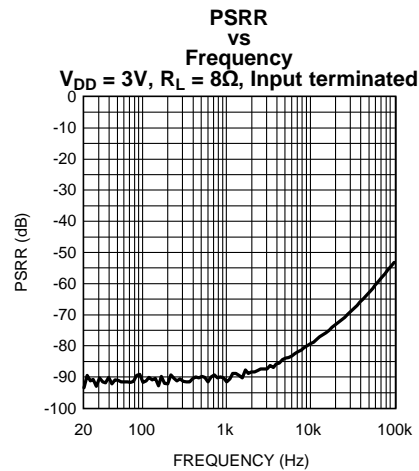

Figure 15.

**Typical Performance Characteristics (continued)**

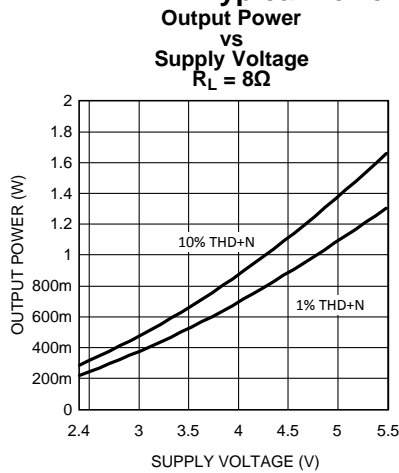

Figure 16.

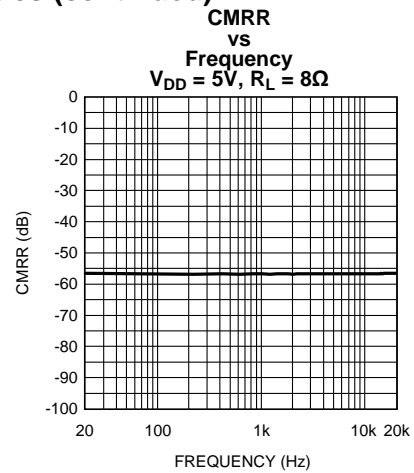

Figure 17.

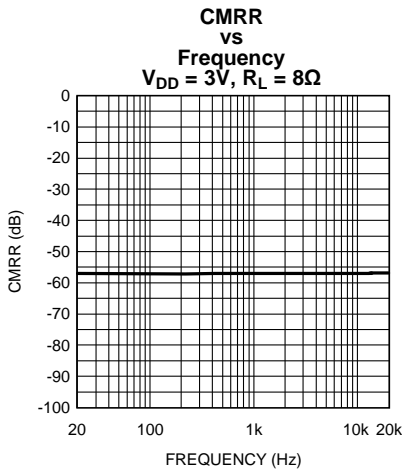

Figure 18.

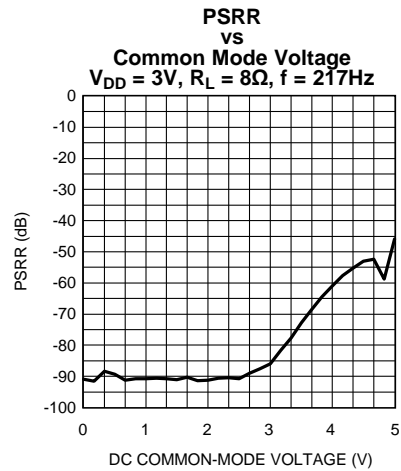

Figure 19.

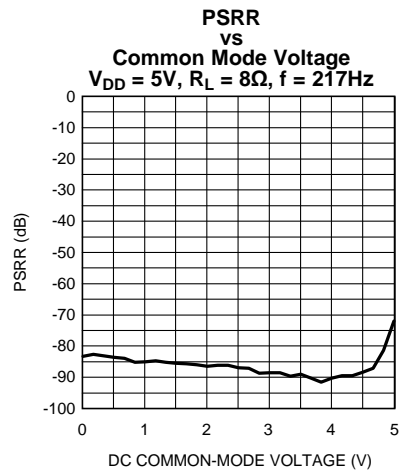

Figure 20.

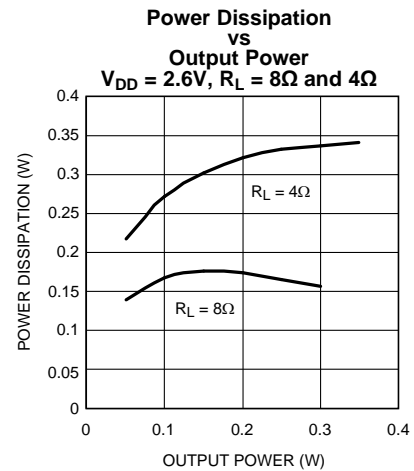

Figure 21.

Typical Performance Characteristics (continued)

Power Dissipation vs Output Power  
 $V_{DD} = 5V, R_L = 8\Omega$

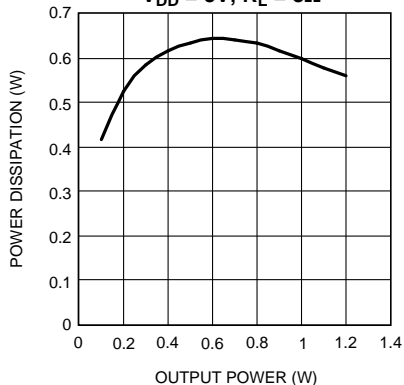

Figure 22.

Power Dissipation vs Output Power  
 $V_{DD} = 3V, R_L = 8\Omega$

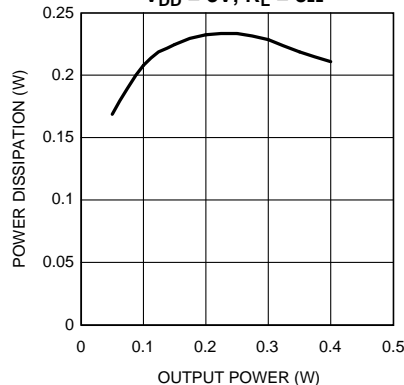

Figure 23.

Power Derating Curve

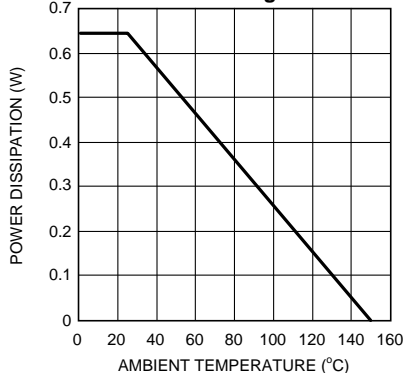

Figure 24.

Noise Floor  
 $V_{DD} = 5V$

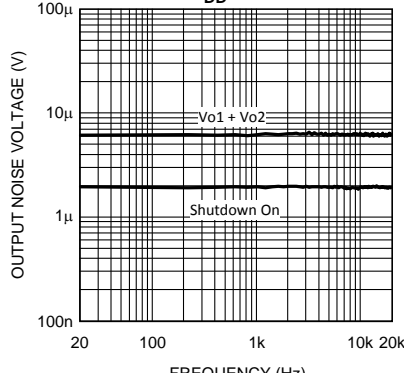

Figure 25.

Noise Floor  
 $V_{DD} = 3V$

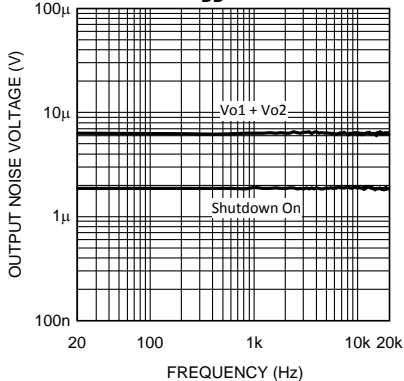

Figure 26.

Clipping Voltage vs Supply Voltage

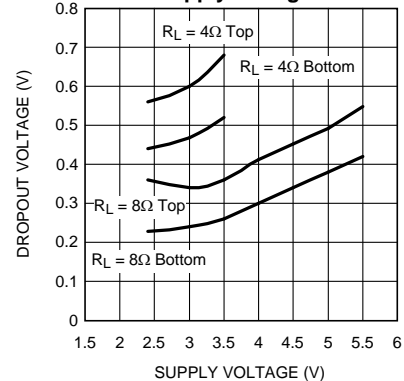

Figure 27.

Typical Performance Characteristics (continued)

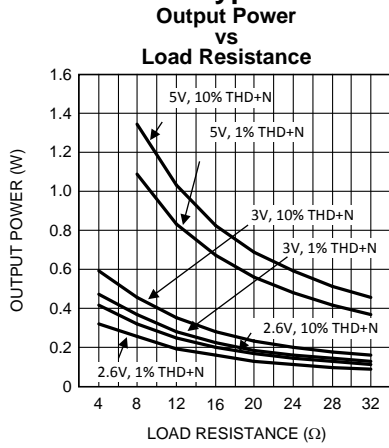

Figure 28.

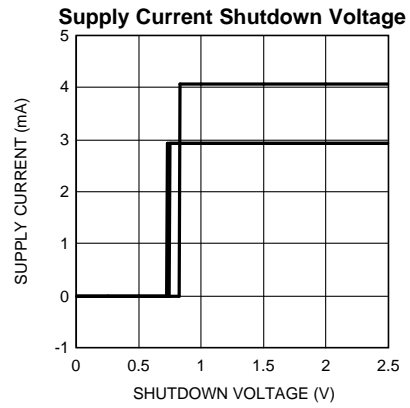

Figure 29.

## APPLICATION INFORMATION

### DIFFERENTIAL AMPLIFIER EXPLANATION

The LM4923 is a fully differential audio amplifier that features differential input and output stages. Internally this is accomplished by two circuits: a differential amplifier and a common mode feedback amplifier that adjusts the output voltages so that the average value remains  $V_{DD} / 2$ . When setting the differential gain, the amplifier can be considered to have "halves". Each half uses an input and feedback resistor ( $R_{i1}$  and  $R_{F1}$ ) to set its respective closed-loop gain (see Figure 1). With  $R_{i1} = R_{i2}$  and  $R_{F1} = R_{F2}$ , the gain is set at  $-R_F / R_i$  for each half. This results in a differential gain of

$$A_{VD} = -R_F/R_i \quad (1)$$

It is extremely important to match the input resistors to each other, as well as the feedback resistors to each other for best amplifier performance. See the [Proper Selection of External Components](#) section for more information. A differential amplifier works in a manner where the difference between the two input signals is amplified. In most applications, this would require input signals that are 180° out of phase with each other. The LM4923 can be used, however, as a single ended input amplifier while still retaining its fully differential benefits. In fact, completely unrelated signals may be placed on the input pins. The LM4923 simply amplifies the difference between them.

All of these applications provide what is known as a "bridged mode" output (bridge-tied-load, BTL). This results in output signals at  $V_{o1}$  and  $V_{o2}$  that are 180° out of phase with respect to each other. Bridged mode operation is different from the single-ended amplifier configuration that connects the load between the amplifier output and ground. A bridged amplifier design has distinct advantages over the single-ended configuration: it provides differential drive to the load, thus doubling maximum possible output swing for a specific supply voltage. Four times the output power is possible compared with a single-ended amplifier under the same conditions. This increase in attainable output power assumes that the amplifier is not current limited or clipped. In order to choose an amplifier's closed-loop gain without causing excess clipping, please refer to the [Audio Power Amplifier Design](#) section.

A bridged configuration, such as the one used in the LM4923, also creates a second advantage over single-ended amplifiers. Since the differential outputs,  $V_{o1}$  and  $V_{o2}$ , are biased at half-supply, no net DC voltage exists across the load. This assumes that the input resistor pair and the feedback resistor pair are properly matched (see [PROPER SELECTION OF EXTERNAL COMPONENTS](#)). BTL configuration eliminates the output coupling capacitor required in single-supply, single-ended amplifier configurations. If an output coupling capacitor is not used in a single-ended output configuration, the half-supply bias across the load would result in both increased internal IC power dissipation as well as permanent loudspeaker damage. Further advantages of bridged mode operation specific to fully differential amplifiers like the LM4923 include increased power supply rejection ratio, common-mode noise reduction, and click and pop reduction.

### EXPOSED-DAP PACKAGE PCB MOUNTING CONSIDERATIONS

The LM4923's exposed-DAP (die attach paddle) package (WQFN) provide a low thermal resistance between the die and the PCB to which the part is mounted and soldered. This allows rapid heat transfer from the die to the surrounding PCB copper traces, ground plane and, finally, surrounding air. Failing to optimize thermal design may compromise the LM4923's high power performance and activate unwanted, though necessary, thermal shutdown protection. The WQFN package must have its DAP soldered to a copper pad on the PCB. The DAP's PCB copper pad is connected to a large plane of continuous unbroken copper. This plane forms a thermal mass and heat sink and radiation area. Place the heat sink area on either outside plane in the case of a two-sided PCB, or on an inner layer of a board with more than two layers. Connect the DAP copper pad to the inner layer or backside copper heat sink area with a thermal via. The via diameter should be 0.012in - 0.013in. Ensure efficient thermal conductivity by plating-through and solder-filling the vias.

Best thermal performance is achieved with the largest practical copper heat sink area. In all circumstances and conditions, the junction temperature must be held below 150°C to prevent activating the LM4923's thermal shutdown protection. [Figure 24](#) in the Typical Performance Characteristics shows the maximum power dissipation versus temperature. Example PCB layouts are shown in the Demonstration Board Layout section. Further detailed and specific information concerning PCB layout, fabrication, and mounting an WQFN package is available from Texas Instruments's package Engineering Group under application note AN1187.

## PCB LAYOUT AND SUPPLY REGULATION CONSIDERATIONS FOR DRIVING 4Ω LOADS

Power dissipated by a load is a function of the voltage swing across the load and the load's impedance. As load impedance decreases, load dissipation becomes increasingly dependent on the interconnect (PCB trace and wire) resistance between the amplifier output pins and the load's connections. Residual trace resistance causes a voltage drop, which results in power dissipated in the trace and not in the load as desired. This problem of decreased load dissipation is exacerbated as load impedance decreases. Therefore, to maintain the highest load dissipation and widest output voltage swing, PCB traces that connect the output pins to a load must be as wide as possible.

Poor power supply regulation adversely affects maximum output power. A poorly regulated supply's output voltage decreases with increasing load current. Reduced supply voltage causes decreased headroom, output signal clipping, and reduced output power. Even with tightly regulated supplies, trace resistance creates the same effects as poor supply regulation. Therefore, making the power supply traces as wide as possible helps maintain full output voltage swing.

## POWER DISSIPATION

Power dissipation is a major concern when designing a successful amplifier, whether the amplifier is bridged or single-ended. [Equation 2](#) states the maximum power dissipation point for a single-ended amplifier operating at a given supply voltage and driving a specified output load.

$$P_{\text{DMAX}} = (V_{\text{DD}})^2 / (2\pi^2 R_L) \text{ Single-Ended} \quad (2)$$

However, a direct consequence of the increased power delivered to the load by a bridge amplifier is an increase in internal power dissipation versus a single-ended amplifier operating at the same conditions.

$$P_{\text{DMAX}} = 4 * (V_{\text{DD}})^2 / (2\pi^2 R_L) \text{ Bridge Mode} \quad (3)$$

Since the LM4923 has bridged outputs, the maximum internal power dissipation is 4 times that of a single-ended amplifier. Even with this substantial increase in power dissipation, the LM4923 does not require additional heatsinking under most operating conditions and output loading. From [Equation 3](#), assuming a 5V power supply and an 8Ω load, the maximum power dissipation point is 625mW. The maximum power dissipation point obtained from [Equation 3](#) must not be greater than the power dissipation results from [Equation 4](#):

$$P_{\text{DMAX}} = (T_{\text{JMAX}} - T_A) / \theta_{\text{JA}} \quad (4)$$

The LM4923's  $\theta_{\text{JA}}$  in an NGP0008A package is 140°C/W. Depending on the ambient temperature,  $T_A$ , of the system surroundings, [Equation 4](#) can be used to find the maximum internal power dissipation supported by the IC packaging. If the result of [Equation 3](#) is greater than that of [Equation 4](#), then either the supply voltage must be decreased, the load impedance increased, the ambient temperature reduced, or the  $\theta_{\text{JA}}$  reduced with heatsinking. In many cases, larger traces near the output,  $V_{\text{DD}}$ , and GND pins can be used to lower the  $\theta_{\text{JA}}$ . The larger areas of copper provide a form of heatsinking allowing higher power dissipation. For the typical application of a 5V power supply, with an 8Ω load, the maximum ambient temperature possible without violating the maximum junction temperature is approximately 62°C provided that device operation is around the maximum power dissipation point. Recall that internal power dissipation is a function of output power. If typical operation is not around the maximum power dissipation point, the LM4923 can operate at higher ambient temperatures. Refer to the [Typical Performance Characteristics](#) curves for power dissipation information.

## POWER SUPPLY BYPASSING

As with any power amplifier, proper supply bypassing is critical for low noise performance and high power supply rejection ratio (PSRR). The capacitor location on both the bypass and power supply pins should be as close to the device as possible. A larger half-supply bypass capacitor improves PSRR because it increases half-supply stability. Typical applications employ a 5V regulator with 10 $\mu$ F and 0.1 $\mu$ F bypass capacitors that increase supply stability. This, however, does not eliminate the need for bypassing the supply nodes of the LM4923. The LM4923 will operate without the bypass capacitor  $C_B$ , although the PSRR may decrease. A 1 $\mu$ F capacitor is recommended for  $C_B$ . This value maximizes PSRR performance. Lesser values may be used, but PSRR decreases at frequencies below 1kHz. The issue of  $C_B$  selection is thus dependant upon desired PSRR and click and pop performance as explained in the section [Proper Selection of External Components](#).

## SHUTDOWN FUNCTION

In order to reduce power consumption while not in use, the LM4923 contains shutdown circuitry that is used to turn off the amplifier's bias circuitry. The device may then be placed into shutdown mode by toggling the Shutdown Select pin to logic low. The trigger point for shutdown is shown as a typical value in the Supply Current vs Shutdown Voltage graphs in the [Typical Performance Characteristics](#) section. It is best to switch between ground and supply for maximum performance. While the device may be disabled with shutdown voltages in between ground and supply, the idle current may be greater than the typical value of 0.1 $\mu$ A. In either case, the shutdown pin should be tied to a definite voltage to avoid unwanted state changes.

In many applications, a microcontroller or microprocessor output is used to control the shutdown circuitry, which provides a quick, smooth transition to shutdown. Another solution is to use a single-throw switch in conjunction with an external pull-up resistor. This scheme ensures that the shutdown pin will not float, thus preventing unwanted state changes.

## PROPER SELECTION OF EXTERNAL COMPONENTS

Proper selection of external components in applications using integrated power amplifiers is critical when optimizing device and system performance. Although the LM4923 is tolerant to a variety of external component combinations, consideration of component values must be made when maximizing overall system quality.

The LM4923 is unity-gain stable, giving the designer maximum system flexibility. The LM4923 should be used in low closed-loop gain configurations to minimize THD+N values and maximize signal to noise ratio. Low gain configurations require large input signals to obtain a given output power. Input signals equal to or greater than 1V<sub>rms</sub> are available from sources such as audio codecs. Please refer to the [AUDIO POWER AMPLIFIER DESIGN](#) section for a more complete explanation of proper gain selection. When used in its typical application as a fully differential power amplifier the LM4923 does not require input coupling capacitors for input sources with DC common-mode voltages of less than  $V_{DD}$ . Exact allowable input common-mode voltage levels are actually a function of  $V_{DD}$ ,  $R_i$ , and  $R_f$  and may be determined by [Equation 5](#):

$$V_{CMi} < (V_{DD}-1.2)*((R_f+(R_i))/(R_i)-V_{DD}*(R_i / 2R_i)) \quad (5)$$

$$-R_f / R_i = A_{VD} \quad (6)$$

Special care must be taken to match the values of the feedback resistors ( $R_{F1}$  and  $R_{F2}$ ) to each other as well as matching the input resistors ( $R_{i1}$  and  $R_{i2}$ ) to each other (see Figure 1) more in front. Because of the balanced nature of differential amplifiers, resistor matching differences can result in net DC currents across the load. This DC current can increase power consumption, internal IC power dissipation, reduce PSRR, and possibly damaging the loudspeaker. The chart below demonstrates this problem by showing the effects of differing values between the feedback resistors while assuming that the input resistors are perfectly matched. The results below apply to the application circuit shown in Figure 1, and assumes that  $V_{DD} = 5V$ ,  $R_L = 8\Omega$ , and the system has DC coupled inputs tied to ground.

Tolerance	R <sub>F1</sub>	R <sub>F2</sub>	V <sub>O2</sub> - V <sub>O1</sub>	I <sub>LOAD</sub>
20%	0.8R	1.2R	-0.500V	62.5mA
10%	0.9R	1.1R	-0.250V	31.25mA
5%	0.95R	1.05R	-0.125V	15.63mA
1%	0.99R	1.01R	-0.025V	3.125mA
0%	R	R	0	0

Similar results would occur if the input resistors were not carefully matched. Adding input coupling capacitors in between the signal source and the input resistors will eliminate this problem, however, to achieve best performance with minimum component count it is highly recommended that both the feedback and input resistors matched to 1% tolerance or better.

## AUDIO POWER AMPLIFIER DESIGN

### Design a 1W/8Ω Audio Amplifier

Given:	
Power Output	1Wrms
Load Impedance	8Ω
Input Level	1Vrms
Input Impedance	20kΩ
Bandwidth	100Hz–20kHz ± 0.25dB

A designer must first determine the minimum supply rail to obtain the specified output power. The supply rail can easily be found by extrapolating from the Output Power vs Supply Voltage graphs in the [Typical Performance Characteristics](#) section. A second way to determine the minimum supply rail is to calculate the required V<sub>OPEAK</sub> using [Equation 7](#) and add the dropout voltages. Using this method, the minimum supply voltage is (V<sub>opeak</sub> + (V<sub>DO TOP</sub> + (V<sub>DO BOT</sub>))), where V<sub>DO BOT</sub> and V<sub>DO TOP</sub> are extrapolated from the Dropout Voltage vs Supply Voltage curve in the [Typical Performance Characteristics](#) section.

$$V_{\text{opeak}} = \sqrt{(2R_L P_O)} \quad (7)$$

Using the Output Power vs Supply Voltage graph for an 8Ω load, the minimum supply rail just about 5V. Extra supply voltage creates headroom that allows the LM4923 to reproduce peaks in excess of 1W without producing audible distortion. At this time, the designer must make sure that the power supply choice along with the output impedance does not violate the conditions explained in the [Power Dissipation](#) section. Once the power dissipation equations have been addressed, the required differential gain can be determined from [Equation 8](#).

$$A_{VD} \geq \sqrt{(P_O R_L)} / (V_{IN}) = V_{\text{orms}} / V_{\text{inrms}} \quad (8)$$

$$R_f / R_i = A_{VD} \quad (9)$$

From [Equation 8](#), the minimum A<sub>VD</sub> is 2.83. Since the desired input impedance was 20kΩ, a ratio of 2.83:1 of R<sub>f</sub> to R<sub>i</sub> results in an allocation of R<sub>i</sub> = 20kΩ for both input resistors and R<sub>f</sub> = 60kΩ for both feedback resistors. The final design step is to address the bandwidth requirement which must be stated as a single -3dB frequency point. Five times away from a -3dB point is 0.17dB down from passband response which is better than the required ±0.25dB specified.

$$f_H = 20\text{kHz} * 5 = 100\text{kHz} \quad (10)$$

The high frequency pole is determined by the product of the desired frequency pole, f<sub>H</sub>, and the differential gain, A<sub>VD</sub>. With a A<sub>VD</sub> = 2.83 and f<sub>H</sub> = 100kHz, the resulting GBWP = 150kHz which is much smaller than the LM4923 GBWP of 10MHz. This figure displays that if a designer has a need to design an amplifier with a higher differential gain, the LM4923 can still be used without running into bandwidth limitations.

## Revision History

Rev	Date	Description
1.0	09/28/07	Added the VSSOP package, then released.
1.01	12/17/07	Updated the mktg outline NGP0008A into the rev B.
1.02	02/19/09	Fixed typo labels on the typical circuit diagram.
E	05/03/13	Changed layout of National Data Sheet to TI format.

**PACKAGING INFORMATION**

Orderable Device	Status (1)	Package Type	Package Drawing	Pins	Package Qty	Eco Plan (2)	Lead/Ball Finish (6)	MSL Peak Temp (3)	Op Temp (°C)	Device Marking (4/5)	Samples
LM4923LQ/NOPB	ACTIVE	WQFN	NGP	8	1000	Green (RoHS & no Sb/Br)	CU SN	Level-3-260C-168 HR	-40 to 85	GB2	<a href="#">Samples</a>
LM4923LQX/NOPB	ACTIVE	WQFN	NGP	8	4500	Green (RoHS & no Sb/Br)	CU SN	Level-3-260C-168 HR	-40 to 85	GB2	<a href="#">Samples</a>
LM4923MM/NOPB	ACTIVE	VSSOP	DGK	8	1000	Green (RoHS & no Sb/Br)	CU SN	Level-1-260C-UNLIM	-40 to 85	GC8	<a href="#">Samples</a>

(1) The marketing status values are defined as follows:

**ACTIVE:** Product device recommended for new designs.

**LIFEBUY:** TI has announced that the device will be discontinued, and a lifetime-buy period is in effect.

**NRND:** Not recommended for new designs. Device is in production to support existing customers, but TI does not recommend using this part in a new design.

**PREVIEW:** Device has been announced but is not in production. Samples may or may not be available.

**OBSOLETE:** TI has discontinued the production of the device.

(2) Eco Plan - The planned eco-friendly classification: Pb-Free (RoHS), Pb-Free (RoHS Exempt), or Green (RoHS & no Sb/Br) - please check <http://www.ti.com/productcontent> for the latest availability information and additional product content details.

**TBD:** The Pb-Free/Green conversion plan has not been defined.

**Pb-Free (RoHS):** TI's terms "Lead-Free" or "Pb-Free" mean semiconductor products that are compatible with the current RoHS requirements for all 6 substances, including the requirement that lead not exceed 0.1% by weight in homogeneous materials. Where designed to be soldered at high temperatures, TI Pb-Free products are suitable for use in specified lead-free processes.

**Pb-Free (RoHS Exempt):** This component has a RoHS exemption for either 1) lead-based flip-chip solder bumps used between the die and package, or 2) lead-based die adhesive used between the die and leadframe. The component is otherwise considered Pb-Free (RoHS compatible) as defined above.

**Green (RoHS & no Sb/Br):** TI defines "Green" to mean Pb-Free (RoHS compatible), and free of Bromine (Br) and Antimony (Sb) based flame retardants (Br or Sb do not exceed 0.1% by weight in homogeneous material)

(3) MSL, Peak Temp. - The Moisture Sensitivity Level rating according to the JEDEC industry standard classifications, and peak solder temperature.

(4) There may be additional marking, which relates to the logo, the lot trace code information, or the environmental category on the device.

(5) Multiple Device Markings will be inside parentheses. Only one Device Marking contained in parentheses and separated by a "~" will appear on a device. If a line is indented then it is a continuation of the previous line and the two combined represent the entire Device Marking for that device.

(6) Lead/Ball Finish - Orderable Devices may have multiple material finish options. Finish options are separated by a vertical ruled line. Lead/Ball Finish values may wrap to two lines if the finish value exceeds the maximum column width.

**Important Information and Disclaimer:** The information provided on this page represents TI's knowledge and belief as of the date that it is provided. TI bases its knowledge and belief on information provided by third parties, and makes no representation or warranty as to the accuracy of such information. Efforts are underway to better integrate information from third parties. TI has taken and

continues to take reasonable steps to provide representative and accurate information but may not have conducted destructive testing or chemical analysis on incoming materials and chemicals. TI and TI suppliers consider certain information to be proprietary, and thus CAS numbers and other limited information may not be available for release.

In no event shall TI's liability arising out of such information exceed the total purchase price of the TI part(s) at issue in this document sold by TI to Customer on an annual basis.

**TAPE AND REEL INFORMATION**

**QUADRANT ASSIGNMENTS FOR PIN 1 ORIENTATION IN TAPE**

\*All dimensions are nominal

Device	Package Type	Package Drawing	Pins	SPQ	Reel Diameter (mm)	Reel Width W1 (mm)	A0 (mm)	B0 (mm)	K0 (mm)	P1 (mm)	W (mm)	Pin1 Quadrant
LM4923LQ/NOPB	WQFN	NGP	8	1000	178.0	12.4	2.2	2.2	1.0	8.0	12.0	Q1
LM4923LQX/NOPB	WQFN	NGP	8	4500	330.0	12.4	2.2	2.2	1.0	8.0	12.0	Q1
LM4923MM/NOPB	VSSOP	DGK	8	1000	178.0	12.4	5.3	3.4	1.4	8.0	12.0	Q1

**TAPE AND REEL BOX DIMENSIONS**

\*All dimensions are nominal

Device	Package Type	Package Drawing	Pins	SPQ	Length (mm)	Width (mm)	Height (mm)
LM4923LQ/NOPB	WQFN	NGP	8	1000	210.0	185.0	35.0
LM4923LQX/NOPB	WQFN	NGP	8	4500	367.0	367.0	35.0
LM4923MM/NOPB	VSSOP	DGK	8	1000	210.0	185.0	35.0

DGK (S-PDSO-G8)

PLASTIC SMALL-OUTLINE PACKAGE

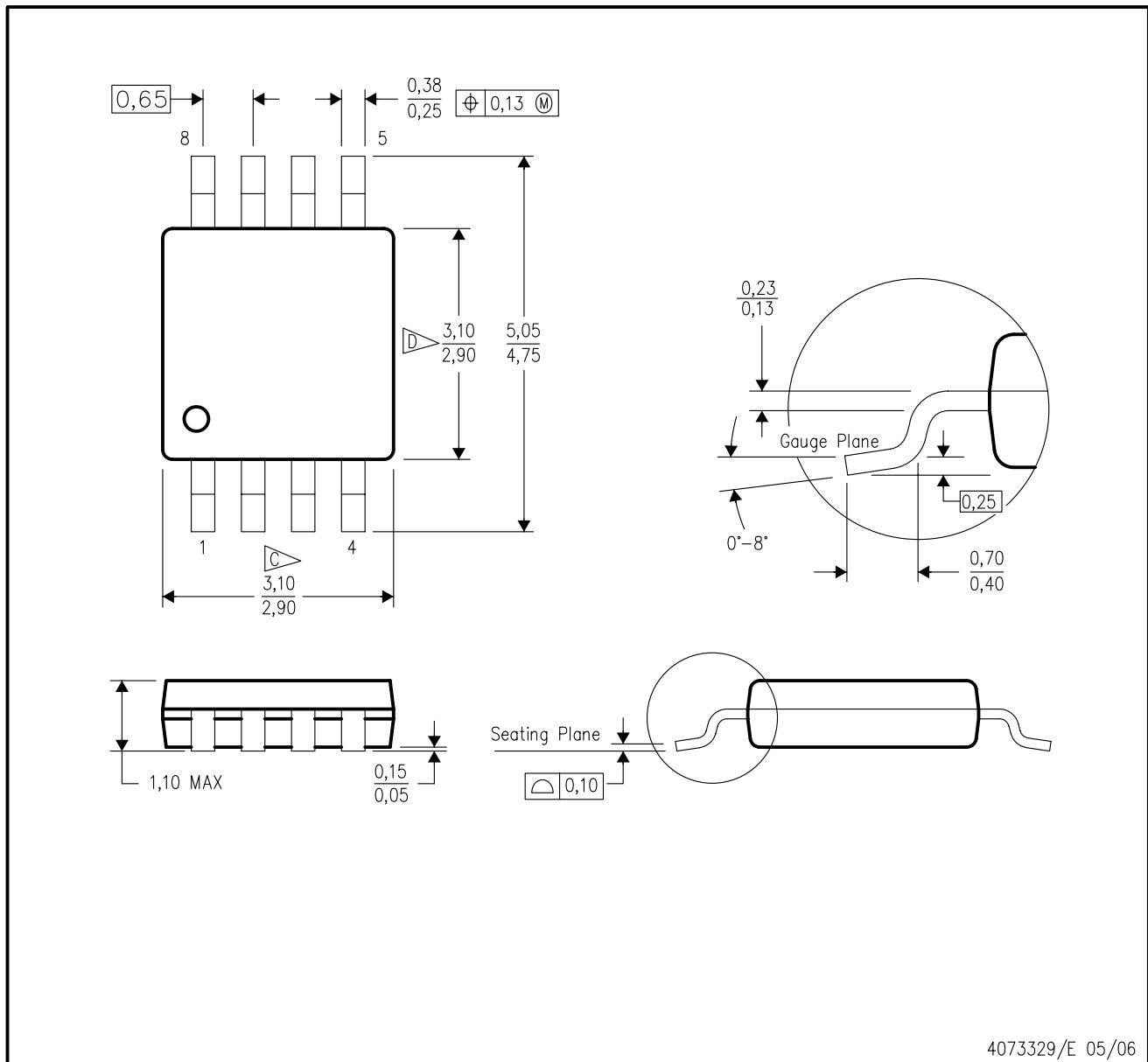

4073329/E 05/06

- NOTES:
- A. All linear dimensions are in millimeters.
  - B. This drawing is subject to change without notice.
  - C. Body length does not include mold flash, protrusions, or gate burrs. Mold flash, protrusions, or gate burrs shall not exceed 0.15 per end.
  - D. Body width does not include interlead flash. Interlead flash shall not exceed 0.50 per side.
  - E. Falls within JEDEC MO-187 variation AA, except interlead flash.



- NOTES:
- A. All linear dimensions are in millimeters.
  - B. This drawing is subject to change without notice.
  - C. Publication IPC-7351 is recommended for alternate designs.
  - D. Laser cutting apertures with trapezoidal walls and also rounding corners will offer better paste release. Customers should contact their board assembly site for stencil design recommendations. Refer to IPC-7525 for other stencil recommendations.
  - E. Customers should contact their board fabrication site for solder mask tolerances between and around signal pads.

NGP0008A

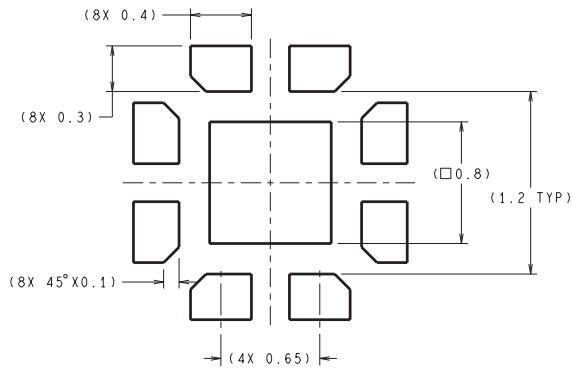

DIMENSIONS ARE IN MILLIMETERS

**RECOMMENDED LAND PATTERN**  
1:1 RATIO WITH PKG SOLDER PADS

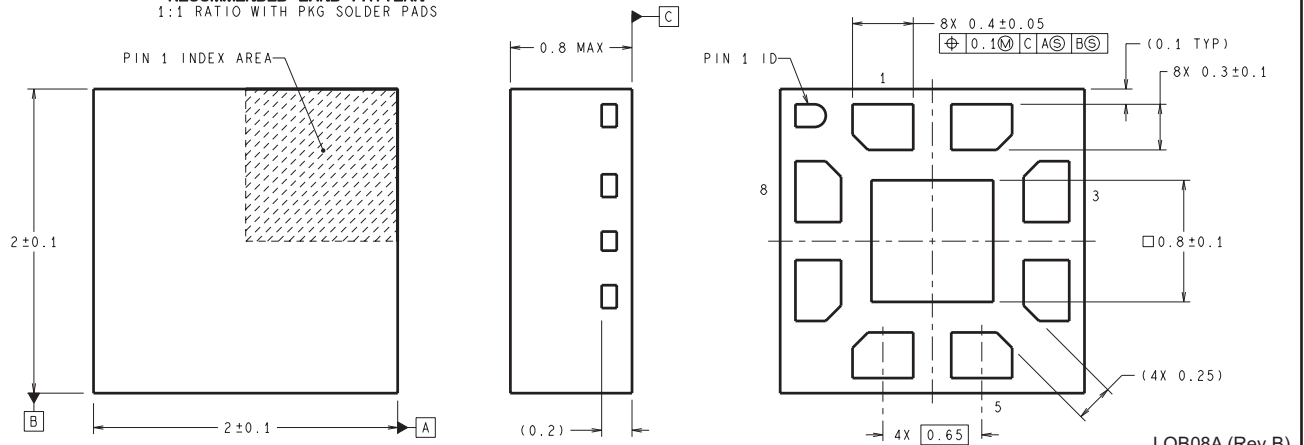

LQB08A (Rev B)

## IMPORTANT NOTICE

Texas Instruments Incorporated and its subsidiaries (TI) reserve the right to make corrections, enhancements, improvements and other changes to its semiconductor products and services per JESD46, latest issue, and to discontinue any product or service per JESD48, latest issue. Buyers should obtain the latest relevant information before placing orders and should verify that such information is current and complete. All semiconductor products (also referred to herein as "components") are sold subject to TI's terms and conditions of sale supplied at the time of order acknowledgment.

TI warrants performance of its components to the specifications applicable at the time of sale, in accordance with the warranty in TI's terms and conditions of sale of semiconductor products. Testing and other quality control techniques are used to the extent TI deems necessary to support this warranty. Except where mandated by applicable law, testing of all parameters of each component is not necessarily performed.

TI assumes no liability for applications assistance or the design of Buyers' products. Buyers are responsible for their products and applications using TI components. To minimize the risks associated with Buyers' products and applications, Buyers should provide adequate design and operating safeguards.

TI does not warrant or represent that any license, either express or implied, is granted under any patent right, copyright, mask work right, or other intellectual property right relating to any combination, machine, or process in which TI components or services are used. Information published by TI regarding third-party products or services does not constitute a license to use such products or services or a warranty or endorsement thereof. Use of such information may require a license from a third party under the patents or other intellectual property of the third party, or a license from TI under the patents or other intellectual property of TI.

Reproduction of significant portions of TI information in TI data books or data sheets is permissible only if reproduction is without alteration and is accompanied by all associated warranties, conditions, limitations, and notices. TI is not responsible or liable for such altered documentation. Information of third parties may be subject to additional restrictions.

Resale of TI components or services with statements different from or beyond the parameters stated by TI for that component or service voids all express and any implied warranties for the associated TI component or service and is an unfair and deceptive business practice. TI is not responsible or liable for any such statements.

Buyer acknowledges and agrees that it is solely responsible for compliance with all legal, regulatory and safety-related requirements concerning its products, and any use of TI components in its applications, notwithstanding any applications-related information or support that may be provided by TI. Buyer represents and agrees that it has all the necessary expertise to create and implement safeguards which anticipate dangerous consequences of failures, monitor failures and their consequences, lessen the likelihood of failures that might cause harm and take appropriate remedial actions. Buyer will fully indemnify TI and its representatives against any damages arising out of the use of any TI components in safety-critical applications.

In some cases, TI components may be promoted specifically to facilitate safety-related applications. With such components, TI's goal is to help enable customers to design and create their own end-product solutions that meet applicable functional safety standards and requirements. Nonetheless, such components are subject to these terms.

No TI components are authorized for use in FDA Class III (or similar life-critical medical equipment) unless authorized officers of the parties have executed a special agreement specifically governing such use.

Only those TI components which TI has specifically designated as military grade or "enhanced plastic" are designed and intended for use in military/aerospace applications or environments. Buyer acknowledges and agrees that any military or aerospace use of TI components which have **not** been so designated is solely at the Buyer's risk, and that Buyer is solely responsible for compliance with all legal and regulatory requirements in connection with such use.

TI has specifically designated certain components as meeting ISO/TS16949 requirements, mainly for automotive use. In any case of use of non-designated products, TI will not be responsible for any failure to meet ISO/TS16949.

### Products

Audio	<a href="http://www.ti.com/audio">www.ti.com/audio</a>
Amplifiers	<a href="http://amplifier.ti.com">amplifier.ti.com</a>
Data Converters	<a href="http://dataconverter.ti.com">dataconverter.ti.com</a>
DLP® Products	<a href="http://www.dlp.com">www.dlp.com</a>
DSP	<a href="http://dsp.ti.com">dsp.ti.com</a>
Clocks and Timers	<a href="http://www.ti.com/clocks">www.ti.com/clocks</a>
Interface	<a href="http://interface.ti.com">interface.ti.com</a>
Logic	<a href="http://logic.ti.com">logic.ti.com</a>
Power Mgmt	<a href="http://power.ti.com">power.ti.com</a>
Microcontrollers	<a href="http://microcontroller.ti.com">microcontroller.ti.com</a>
RFID	<a href="http://www.ti-rfid.com">www.ti-rfid.com</a>
OMAP Applications Processors	<a href="http://www.ti.com/omap">www.ti.com/omap</a>
Wireless Connectivity	<a href="http://www.ti.com/wirelessconnectivity">www.ti.com/wirelessconnectivity</a>

### Applications

Automotive and Transportation	<a href="http://www.ti.com/automotive">www.ti.com/automotive</a>
Communications and Telecom	<a href="http://www.ti.com/communications">www.ti.com/communications</a>
Computers and Peripherals	<a href="http://www.ti.com/computers">www.ti.com/computers</a>
Consumer Electronics	<a href="http://www.ti.com/consumer-apps">www.ti.com/consumer-apps</a>
Energy and Lighting	<a href="http://www.ti.com/energy">www.ti.com/energy</a>
Industrial	<a href="http://www.ti.com/industrial">www.ti.com/industrial</a>
Medical	<a href="http://www.ti.com/medical">www.ti.com/medical</a>
Security	<a href="http://www.ti.com/security">www.ti.com/security</a>
Space, Avionics and Defense	<a href="http://www.ti.com/space-avionics-defense">www.ti.com/space-avionics-defense</a>
Video and Imaging	<a href="http://www.ti.com/video">www.ti.com/video</a>

### TI E2E Community

[e2e.ti.com](http://e2e.ti.com)

## Looking for pricing, stock, or lifecycle information?

Click below to explore more details on WIN SOURCE:

 [View LM4923LQ/NOPB on WIN SOURCE](#)

 [Texas Instruments](#) Information

## Optimize Your Supply Chain with WIN SOURCE Solutions

-  Global Sourcing Solution
-  Obsolete Management
-  Cost Control Management
-  Shortage Management
-  Alternative Solution
-  Excess Inventory Management