



**THE DATASHEET OF
IRS21281PBF**



IRS212(7, 71, 8, 81)(S)PbF

CURRENT SENSING SINGLE CHANNEL DRIVER

Features

- Floating channel designed for bootstrap operation
Fully operational to +600 V
Tolerant to negative transient voltage dV/dt immune
- Application-specific gate drive range:
Motor Drive: 12 V to 20 V (IRS2127/IRS2128)
Automotive: 9 V to 20 V (IRS21271/IRS21281)
- Undervoltage lockout
- 3.3 V, 5 V, and 15 V input logic compatible
- FAULT lead indicates shutdown has occurred
- Output in phase with input (IRS2127/IRS21271)
- Output out of phase with input (IRS2128/IRS21281)
- RoHS compliant

Description

The IRS2127/IRS2128/IRS21271/IRS21281 are high voltage, high speed power MOSFET and IGBT drivers. Proprietary HVIC and latch immune CMOS technologies enable ruggedized monolithic construction. The logic input is compatible with standard CMOS or LSTTL outputs, down to 3.3 V. The protection circuitry detects over-current in the driven power transistor and terminates the gate drive voltage. An open drain FAULT signal is provided to indicate that an over-current shutdown has occurred. The output driver features a high pulse current buffer stage designed for minimum cross-conduction. The floating channel can be used to drive an N-channel power MOSFET or IGBT in the high-side or low-side configuration which operates up to 600 V.

Product Summary

V_{OFFSET}	600 V max.
I_{O+/-}	200 mA / 420 mA
V_{OUT}	12 V - 20V 9 V - 20 V (IRS2127/IR2128) (IRS21271/IR21281)
V_{Csth}	250 mV or 1.8 V
ton/off (typ.)	150 ns & 150 ns

Packages

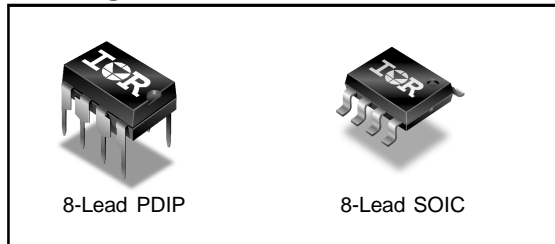

Typical Connection

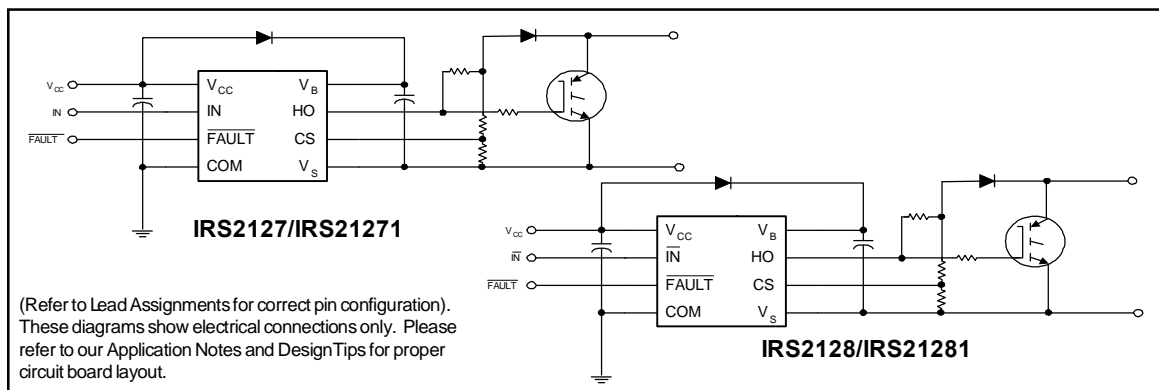

Absolute Maximum Ratings

Absolute maximum ratings indicate sustained limits beyond which damage to the device may occur. All voltage parameters are absolute voltages referenced to COM. The thermal resistance and power dissipation ratings are measured under board mounted and still air conditions.

Symbol	Definition	Min.	Max.	Units	
V _B	High-side floating supply voltage	-0.3	625	V	
V _S	High-side floating offset voltage	V _B - 25	V _B + 0.3		
V _{HO}	High-side floating output voltage	V _S - 0.3	V _B + 0.3		
V _{CC}	Logic supply voltage	-0.3	25		
V _{IN}	Logic input voltage	-0.3	V _{CC} + 0.3		
V _{FLT}	$\overline{\text{FAULT}}$ output voltage	-0.3	V _{CC} + 0.3		
V _{CS}	Current sense voltage	V _S - 0.3	V _B + 0.3		
dV _S /dt	Allowable offset supply voltage transient	—	50	V/ns	
P _D	Package power dissipation @ T _A ≤ +25 °C	8-Lead DIP	—	1.0	W
		8-Lead SOIC	—	0.625	
R _{thJA}	Thermal resistance, junction to ambient	8-Lead DIP	—	125	°C/W
		8-Lead SOIC	—	200	
T _J	Junction temperature	—	150	°C	
T _S	Storage temperature	-55	150		
T _L	Lead temperature (soldering, 10 seconds)	—	300		

Recommended Operating Conditions

The input/output logic timing diagram is shown in Fig. 1. For proper operation the device should be used within the recommended conditions. The V_S offset rating is tested with all supplies biased at 15 V differential.

Symbol	Definition	Min.	Max.	Units	
V _B	High-side floating supply voltage	(IRS2127/IRS2128)	V _S + 12	V _S + 20	V
		(IRS21271/IRS21281)	V _S + 9	V _S + 20	
V _S	High-side floating offset voltage	Note 1	600		
V _{HO}	High-side floating output voltage	V _S	V _B		
V _{CC}	Logic supply voltage	10	20		
V _{IN}	Logic input voltage	0	V _{CC}		
V _{FLT}	$\overline{\text{FAULT}}$ output voltage	0	V _{CC}		
V _{CS}	Current sense signal voltage	V _S	V _S + 5		
T _A	Ambient temperature	-40	125	°C	

Note 1: Logic operational for V_S of -5 V to +600 V. Logic state held for V_S of -5 V to -V_{BS}. (Please refer to the Design Tip DT97-3 for more details).

Dynamic Electrical Characteristics

V_{BIAS} (V_{CC} , V_{BS}) = 15 V, C_L = 1000 pF and T_A = 25 °C unless otherwise specified. The dynamic electrical characteristics are measured using the test circuit shown in Fig. 3.

Symbol	Definition	Min.	Typ.	Max.	Units	Test Conditions
t_{on}	Turn-on propagation delay	—	150	200	ns	$V_S = 0$ V
t_{off}	Turn-off propagation delay	—	150	200		$V_S = 600$ V
t_r	Turn-on rise time	—	80	130		
t_f	Turn-off fall time	—	40	65		
t_{bl}	Start-up blanking time	550	750	950		
t_{cs}	CS shutdown propagation delay	—	65	360		
t_{ft}	CS to FAULT pull-up propagation delay	—	270	510		

Static Electrical Characteristics

V_{BIAS} (V_{CC} , V_{BS}) = 15 V and T_A = 25 °C unless otherwise specified. The V_{IN} , V_{TH} , and I_{IN} parameters are referenced to COM. The V_O and I_O parameters are referenced to V_S .

Symbol	Definition	Min.	Typ.	Max.	Units	Test Conditions	
V_{IH}	Logic "1" input voltage (IRS2127/IRS21271)	2.5	—	—	V	$V_{CC} = 10$ V to 20 V	
	Logic "0" input voltage (IRS2128/IRS21281)						
V_{IL}	Logic "0" input voltage (IRS2127/IRS21271)	—	—	0.8	V		
	Logic "1" input voltage (IRS2128/IRS21281)						
V_{CSTH+}	CS input positive going threshold	(IRS2127/IRS2128)	180	250	320		mV
		(IRS21271/IRS21281)	1.5	1.8	2.1		V
V_{OH}	High level output voltage, $V_{BIAS} - V_O$	—	0.05	0.2	V		$I_O = 2$ mA
V_{OL}	Low level output voltage, V_O	—	0.02	0.1			
I_{LK}	Offset supply leakage current	—	—	50	μ A		$V_B = V_S = 600$ V
I_{QBS}	Quiescent V_{BS} supply current	—	300	800			$V_{IN} = 0$ V or 5 V
I_{QCC}	Quiescent V_{CC} supply current	—	60	120		$V_{IN} = 5$ V	
I_{IN+}	Logic "1" input bias current	—	7.0	15		$V_{IN} = 0$ V	
I_{IN-}	Logic "0" input bias current	—	—	5.0		$V_{CS} = 3$ V	
I_{CS+}	"High" CS bias current	—	—	5.0		$V_{CS} = 0$ V	
I_{CS-}	"High" CS bias current	—	—	5.0			
V_{BSUV+}	V_{BS} supply undervoltage positive going threshold	(IRS2127/IRS2128)	8.8	10.3	11.8	V	
		(IRS21271/IRS21281)	6.3	7.2	8.2		
V_{BSUV-}	V_{BS} supply undervoltage negative going threshold	(IRS2127/IRS2128)	7.5	9.0	10.6		
		(IRS21271/IRS21281)	6.0	6.8	7.7		
I_{O+}	Output high short circuit pulsed current	200	290	—	mA		$V_O = 0$ V, $V_{IN} = 5$ V PW ≤ 10 μ s
I_{O-}	Output low short circuit pulsed current	420	600	—			$V_O = 15$ V, $V_{IN} = 0$ V PW ≤ 10 μ s
$R_{on,FLT}$	FAULT - low on resistance	—	125	—	Ω		

Functional Block Diagram IRS2127/IRS21271

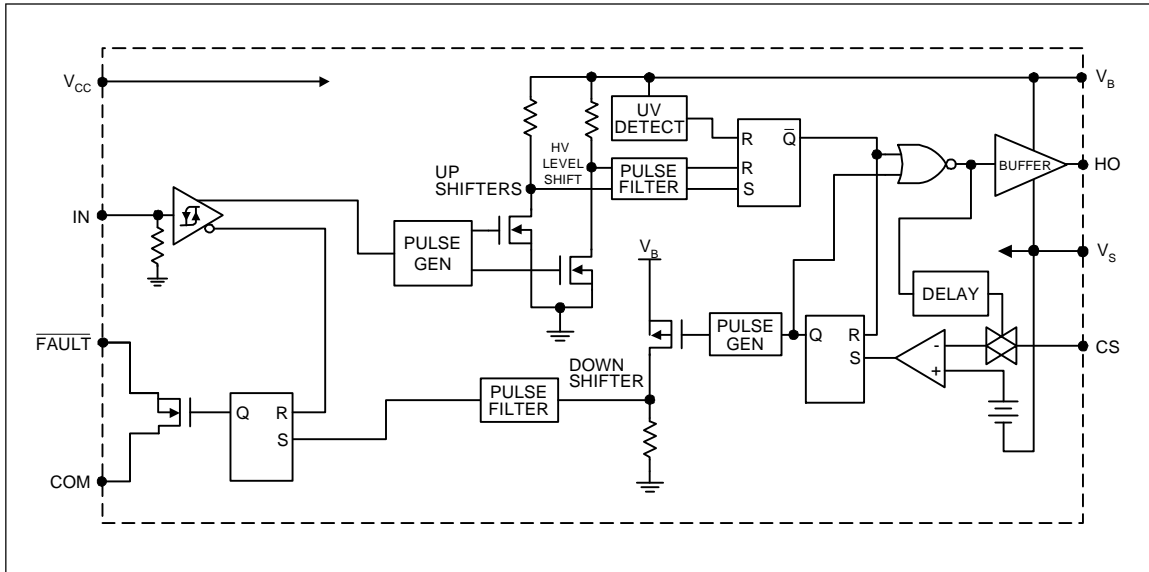

Functional Block Diagram IRS2128/IRS21281

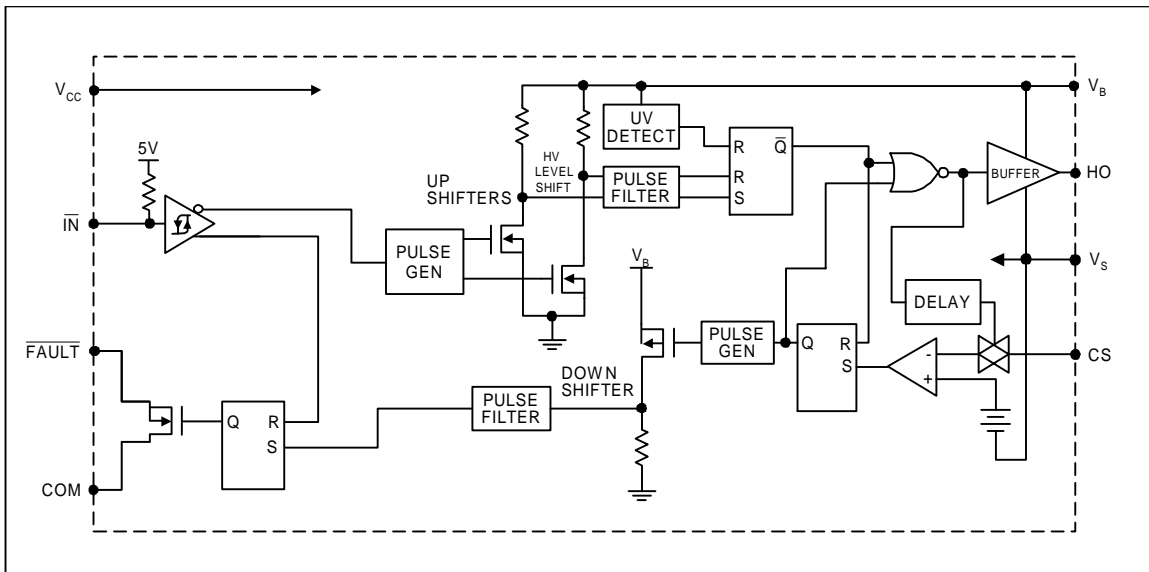

Lead Definitions

Symbol	Description
V _{CC}	Logic and gate drive supply
IN	Logic input for gate driver output (HO), in phase with HO (IRS2127/IRS21271) out of phase with HO (IRS2128/IRS21281)
FAULT	Indicates over-current shutdown has occurred, negative logic
COM	Logic ground
V _B	High-side floating supply
HO	High-side gate drive output
V _S	High-side floating supply return
CS	Current sense input to current sense comparator

Lead Assignments

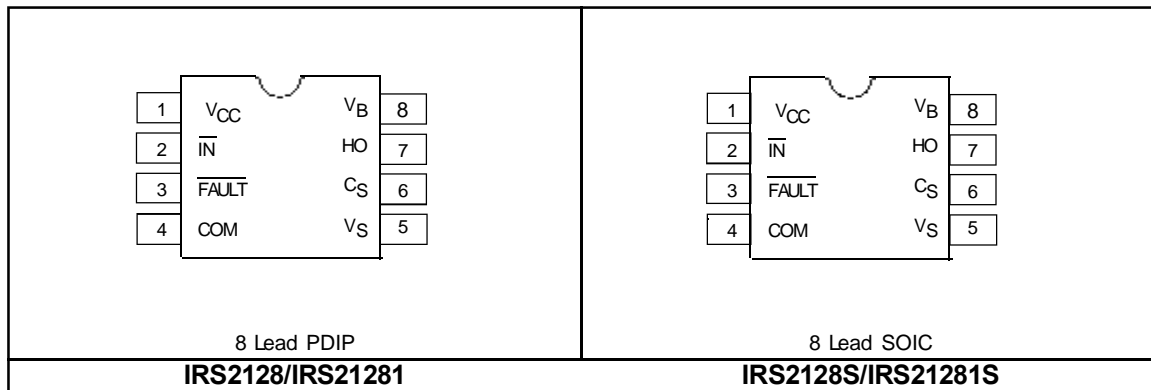
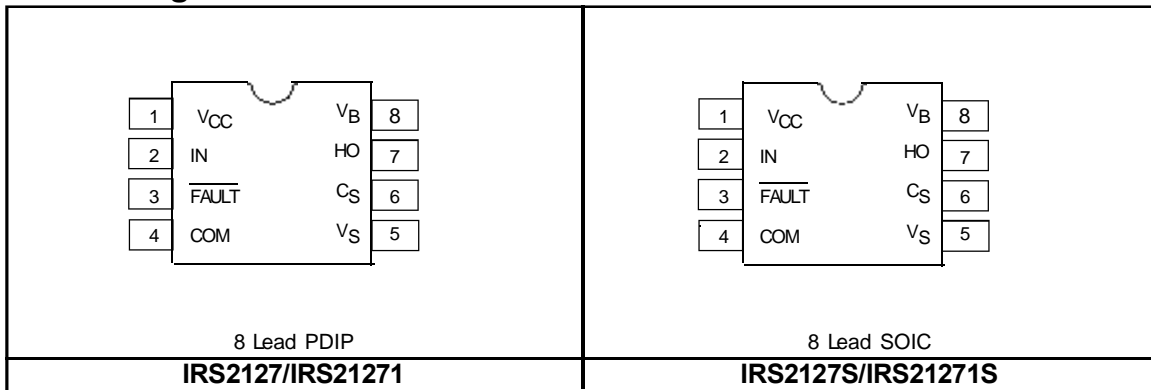

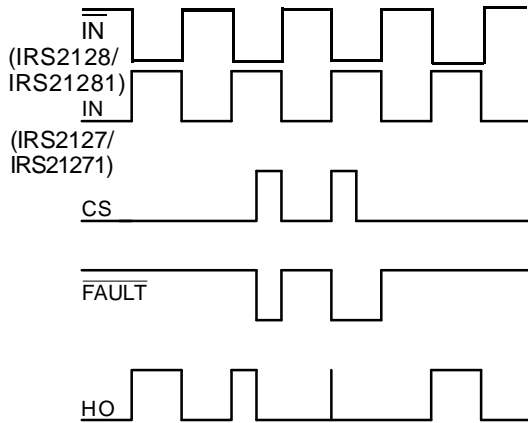

Figure 1. Input/Output Timing Diagram

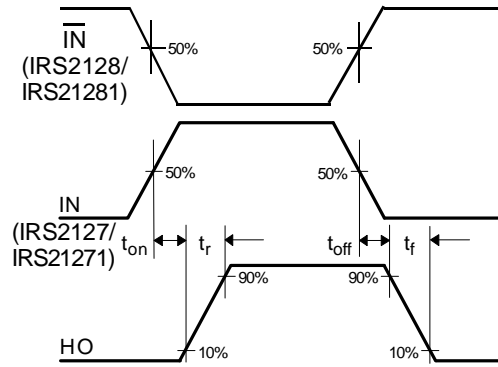

Figure 2. Switching Time Waveform Definition

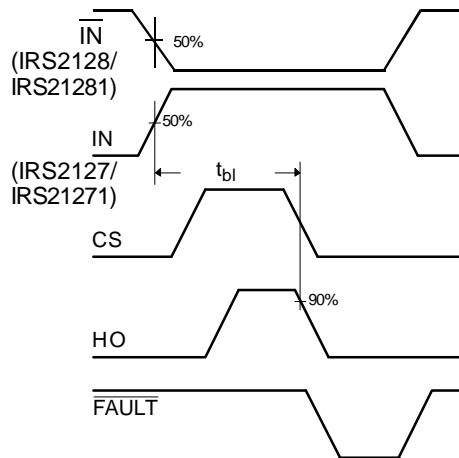

Figure 3. Start-Up Blanking Time Waveform Definitions

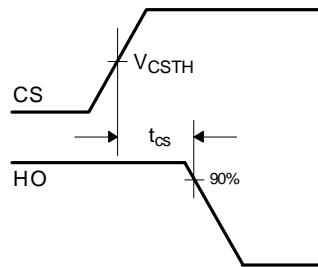

Figure 4. CS Shutdown Waveform Definitions

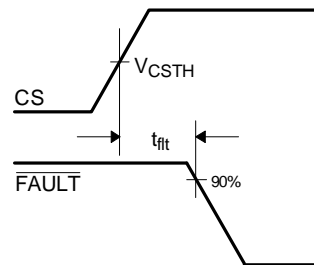

Figure 5. CS to FAULT Waveform Definitions

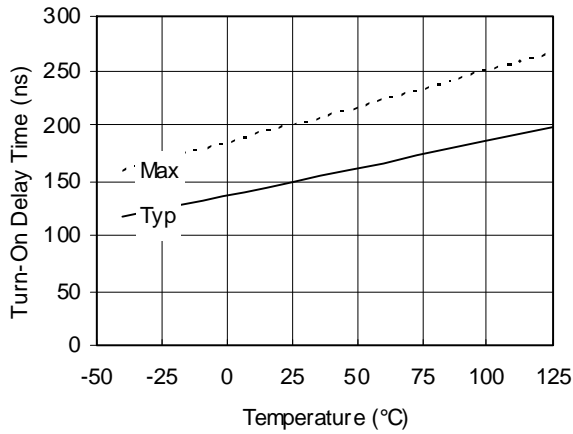

Figure 6A. Turn-On Delay Time vs. Temperature

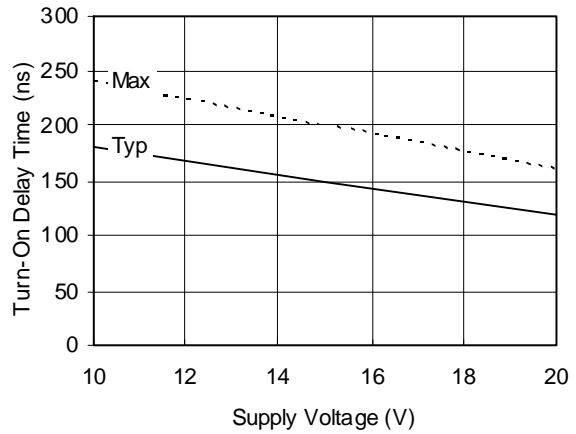

Figure 6B. Turn-On Delay Time vs. Voltage

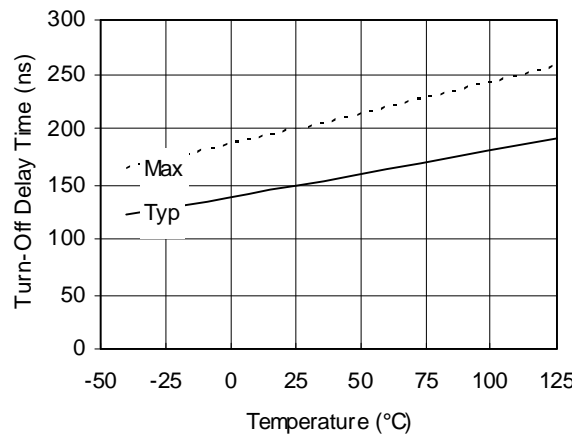

Figure 7A. Turn-Off Delay Time vs. Temperature

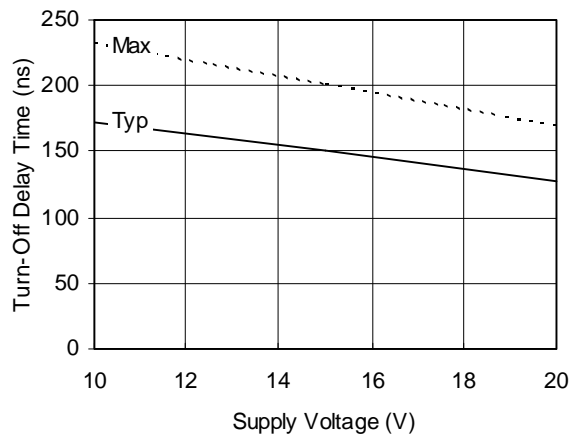

Figure 7B. Turn-Off Delay Time vs. Voltage



IRS212(7, 71, 8, 81)(S)PbF

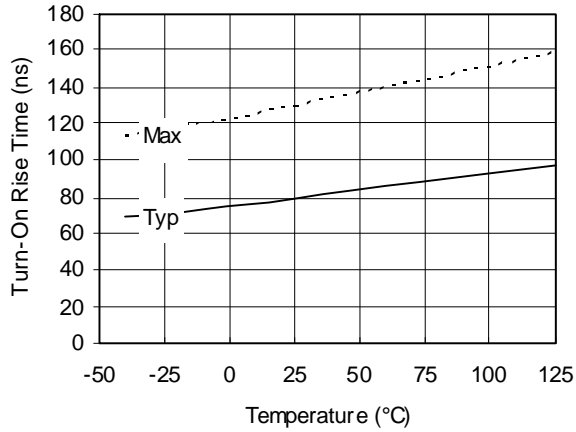

Figure 8A. Turn-On Rise Time vs. Temperature

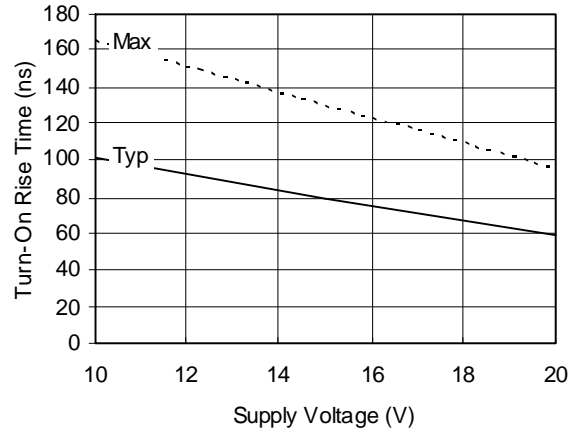

Figure 8B. Turn-On Rise Time vs. Voltage

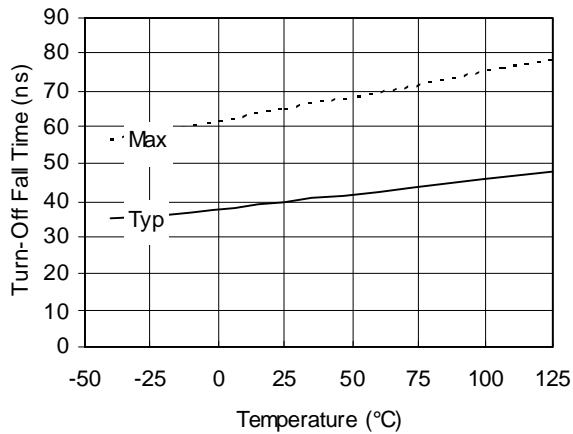

Figure 9A. Turn-Off Fall Time vs. Temperature

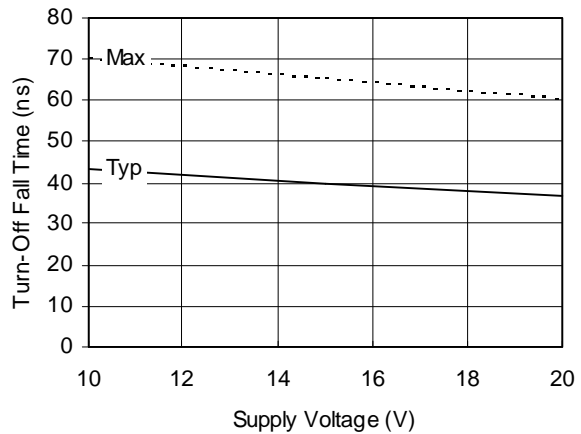

Figure 9B. Turn-Off Fall Time vs. Voltage

IRS212(7, 71, 8, 81)(S)PbF

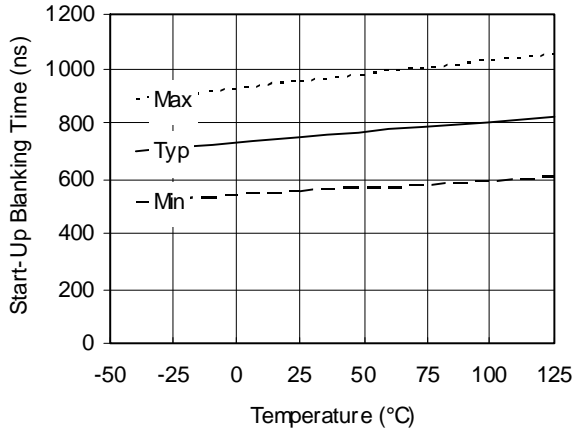

Figure 10A. Start-Up Blanking Time vs. Temperature

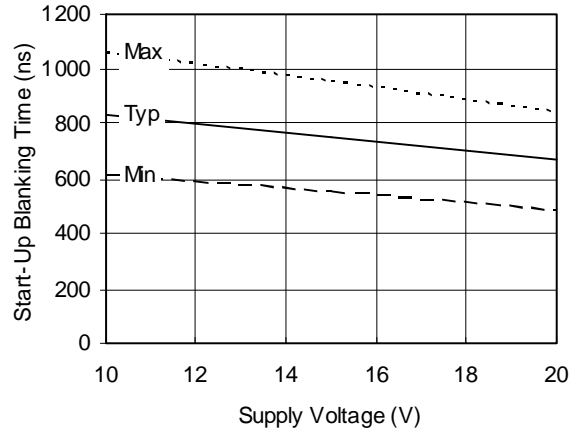

Figure 10B. Start-Up Blanking Time vs. Voltage

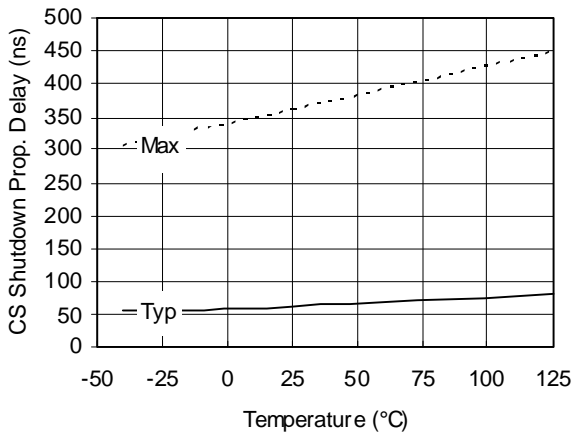

Figure 11A. CS Shutdown Prop. Delay vs. Temperature

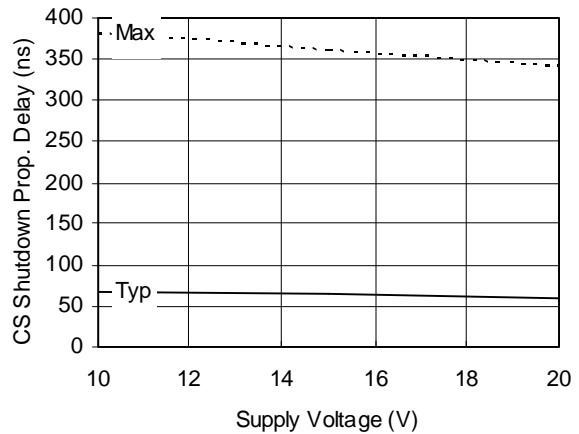

Figure 11B. CS Shutdown Prop. Delay vs. Voltage

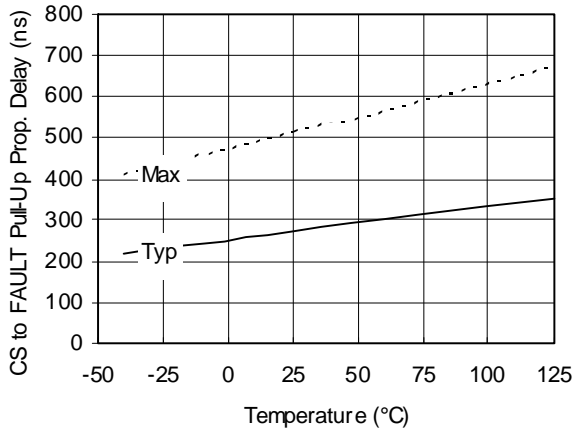

Figure 12A. CS to FAULT Pull-Up Prop. Delay vs. Temperature

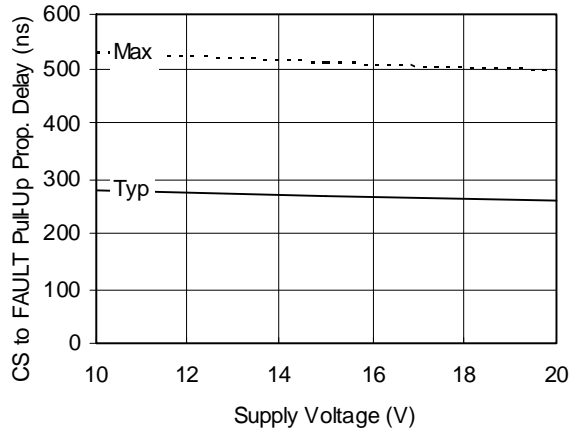

Figure 12B. CS to FAULT Pull-Up Prop. Delay vs. Voltage

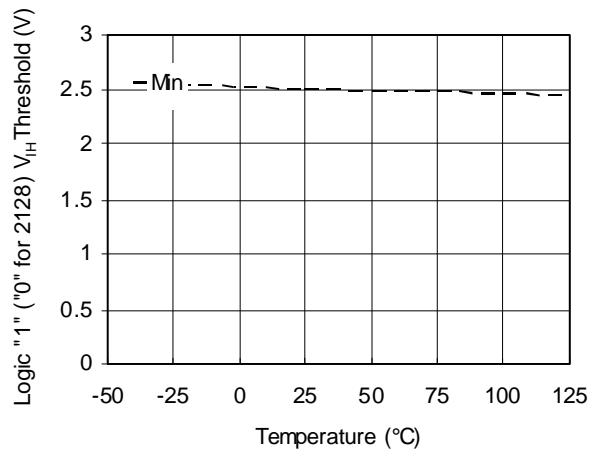

Figure 13A. Logic "1" ("0" for 2128) V_{IH} Threshold vs. Temperature

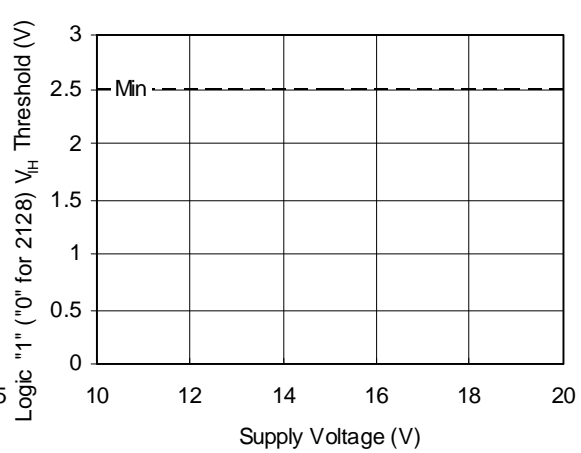

Figure 13B. Logic "1" ("0" for 2128) V_{IH} Threshold vs. Voltage

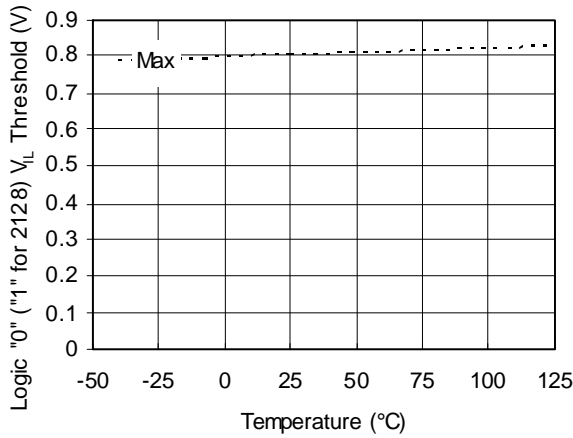

Figure 14A. Logic "0" ("1" for 2128) V_{IL} Threshold vs. Temperature

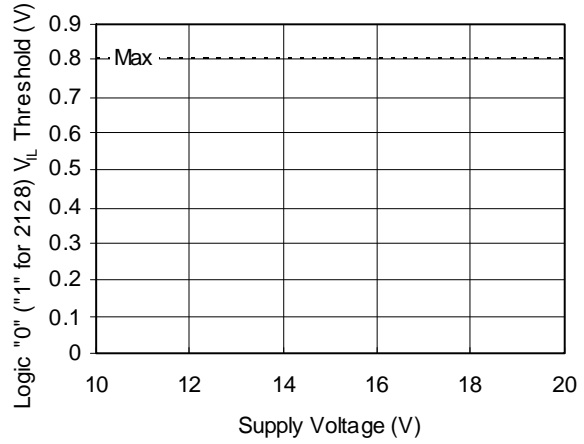

Figure 14B. Logic "0" ("1" for 2128) V_{IL} Threshold vs. Voltage

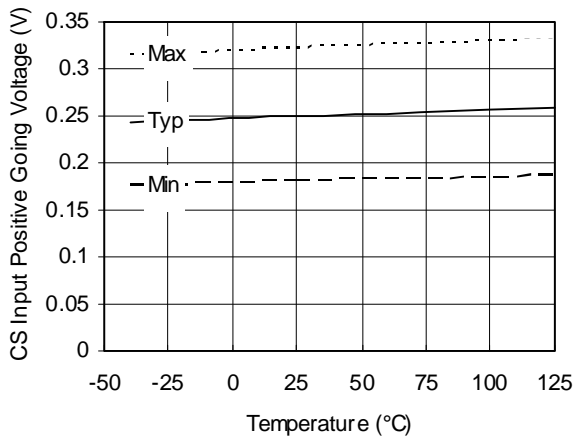

Figure 15A. CS Input Positive Going Voltage vs. Temperature

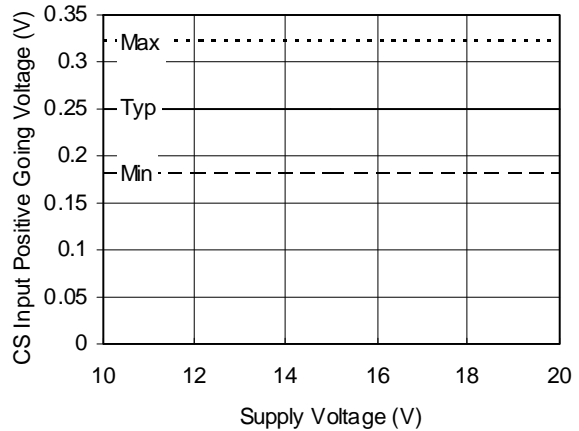

Figure 15B. CS Input Positive Going Voltage vs. Voltage

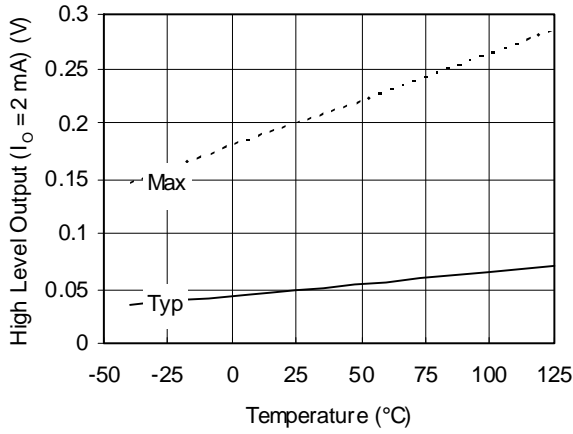

Figure 16A. High Level Output ($I_o = 2 \text{ mA}$) vs. Temperature

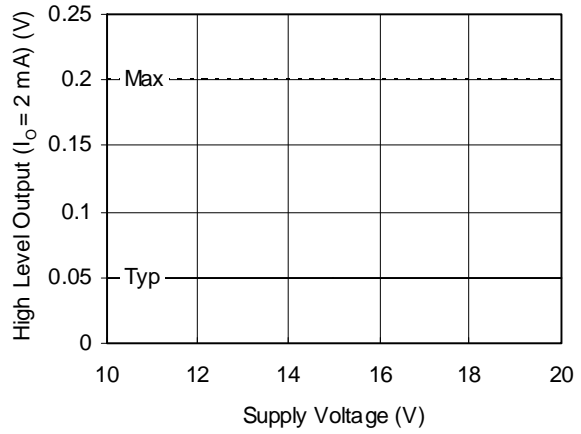

Figure 16B. High Level Output ($I_o = 2 \text{ mA}$) vs. Voltage

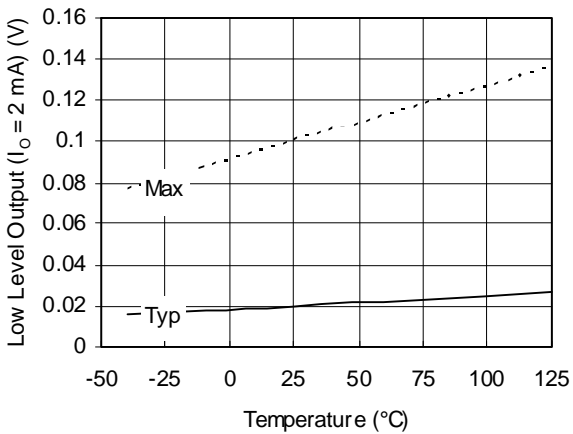

Figure 17A. Low Level Output ($I_o = 2 \text{ mA}$) vs. Temperature

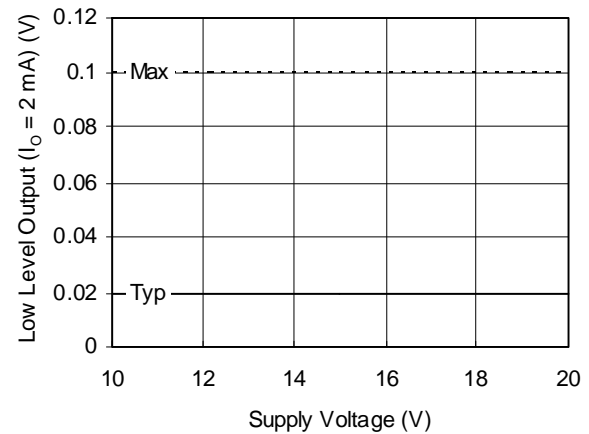

Figure 17B. Low Level Output ($I_o = 2 \text{ mA}$) vs. Voltage

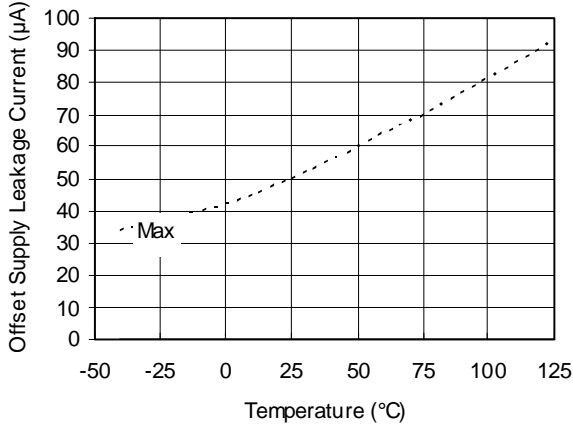

Figure 18A. Offset Supply Leakage Current vs. Temperature

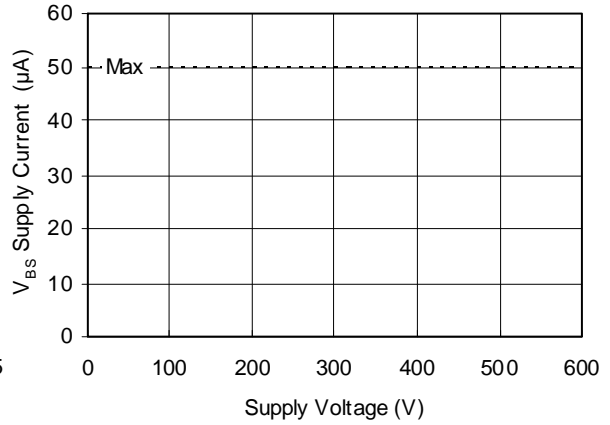

Figure 18B. High-Side Floating Well Offset Supply Leakage vs. Voltage

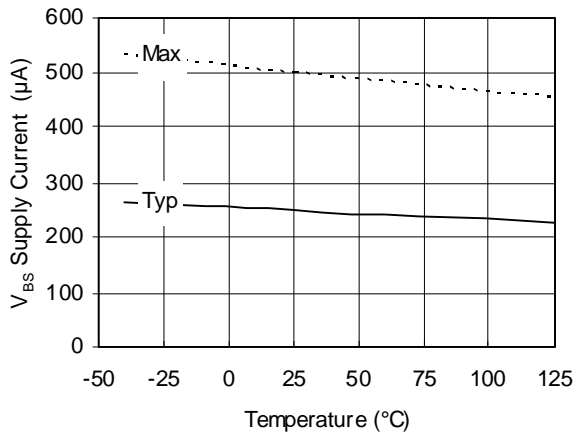

Figure 19A. V_{BS} Supply Current vs. Temperature

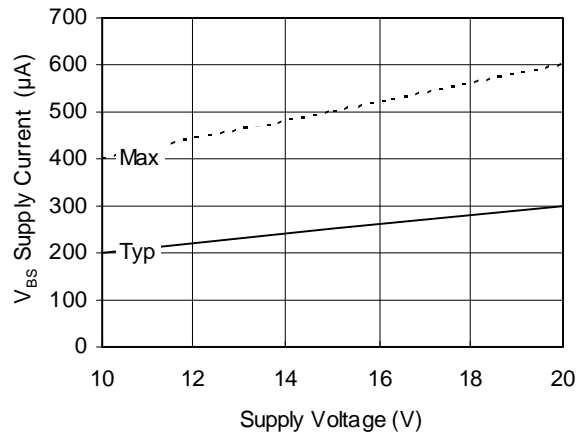

Figure 19B. V_{BS} Supply Current vs. Voltage

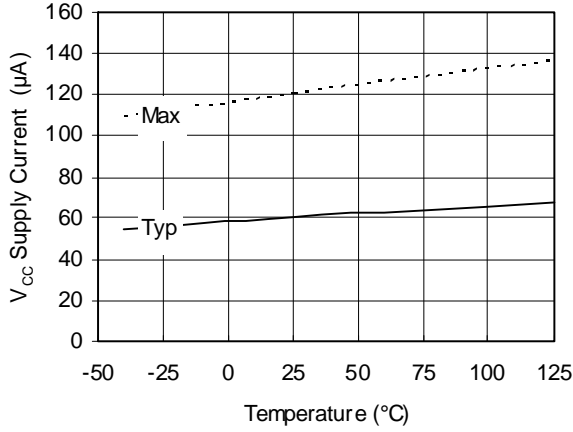

Figure 20A. V_{CC} Supply Current vs. Temperature

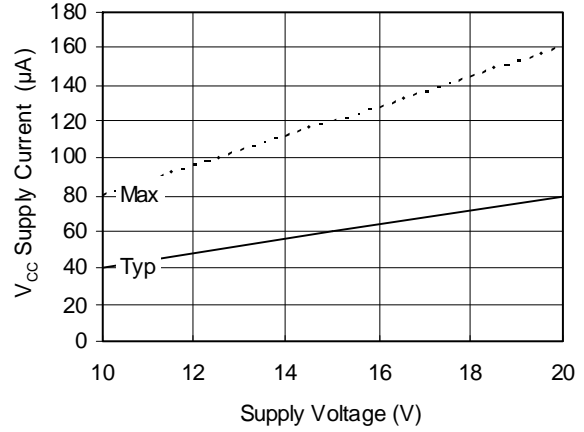

Figure 20B. V_{CC} Supply Current vs. Voltage

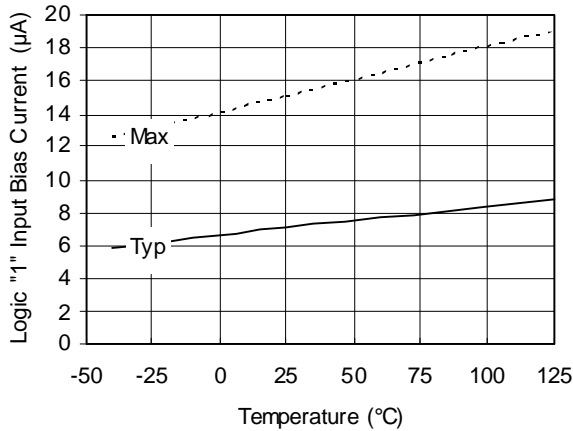

Figure 21A. Logic "1" Input Bias Current vs. Temperature

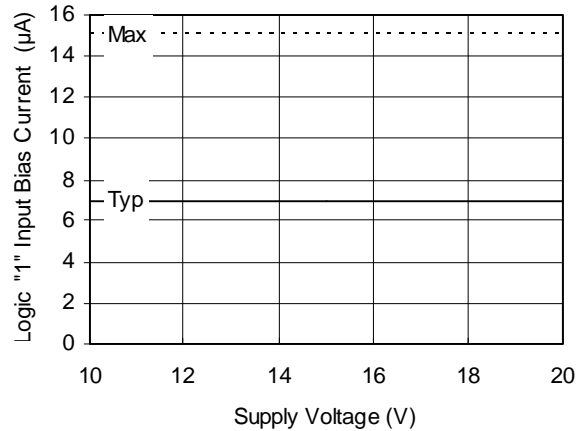

Figure 21B. Logic "1" Input Bias Current vs. Voltage

IRS212(7, 71, 8, 81)(S)PbF

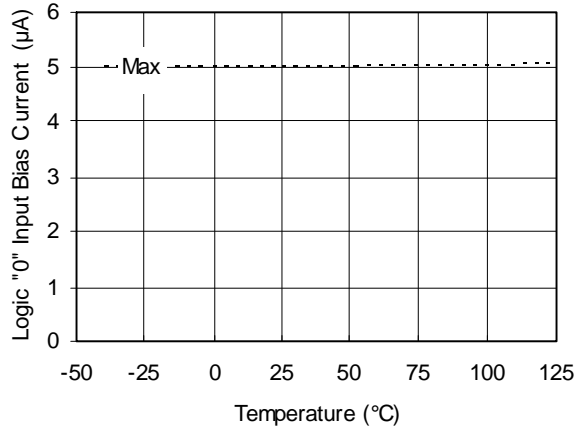

Figure 22A. Logic "0" Input Bias Current vs. Temperature

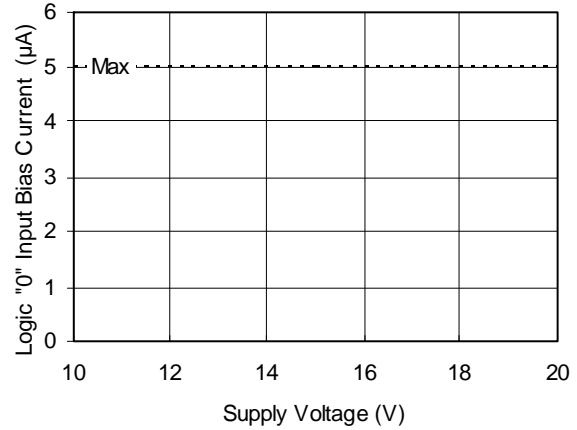

Figure 22B. Logic "0" Input Bias Current vs. Voltage

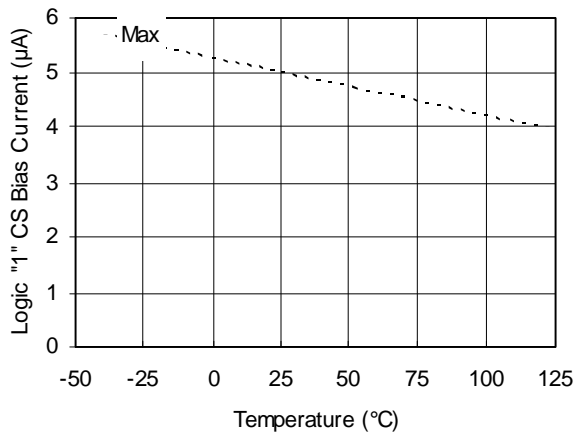

Figure 23A. Logic "1" CS Bias Current vs. Temperature

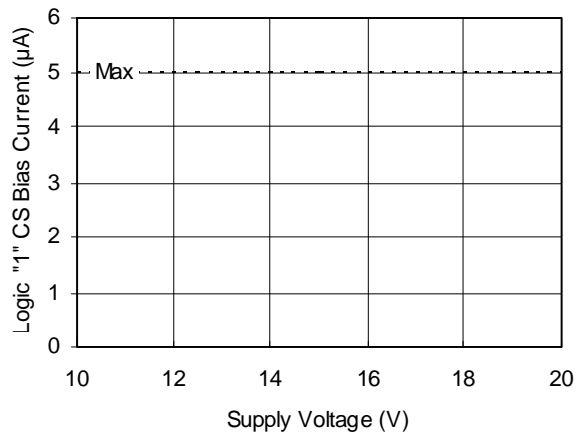

Figure 23B. Logic "1" CS Bias Current vs. Voltage

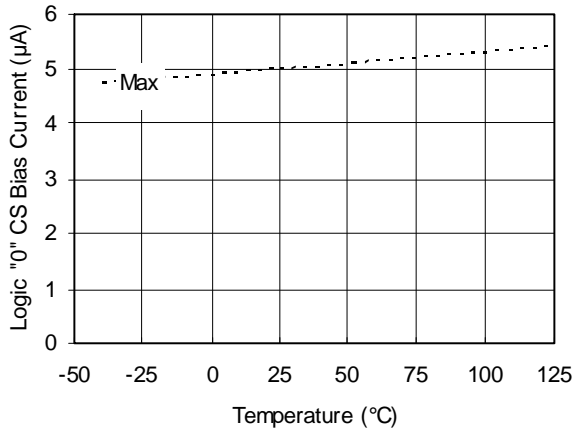

Figure 24A. Logic "0" CS Bias Current vs. Temperature

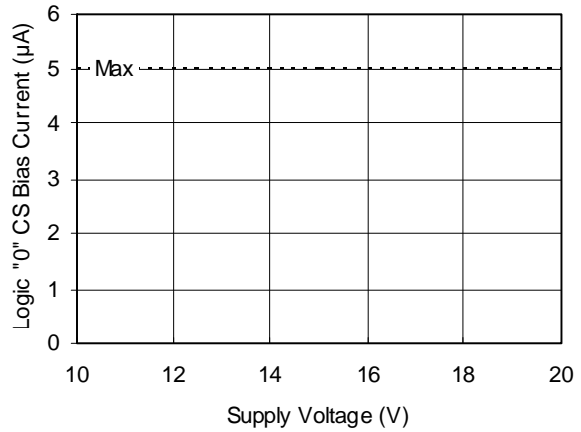

Figure 24B. Logic "0" CS Bias Current vs. Voltage

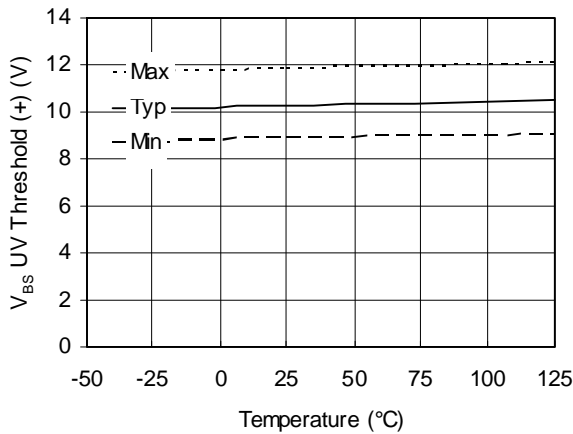

Figure 25A. V_{BS} UV Threshold (+) vs. Temperature

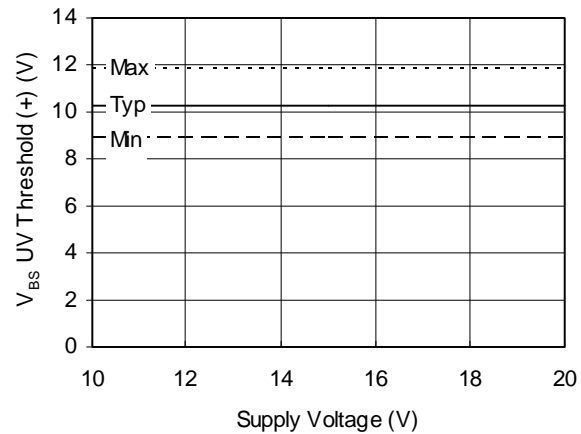

Figure 25B. V_{BS} UV Threshold (+) vs. Voltage

IRS212(7, 71, 8, 81)(S)PbF

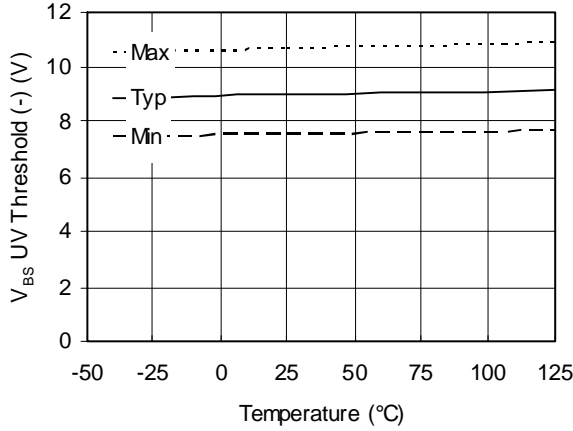

Figure 26A. V_{BS} UV Threshold (-) vs. Temperature

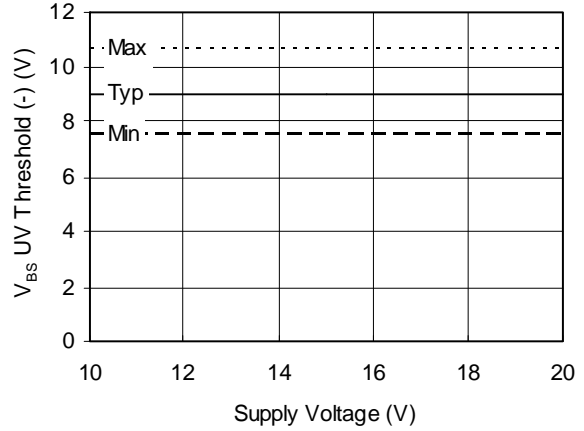

Figure 26B. V_{BS} UV Threshold (-) vs. Voltage

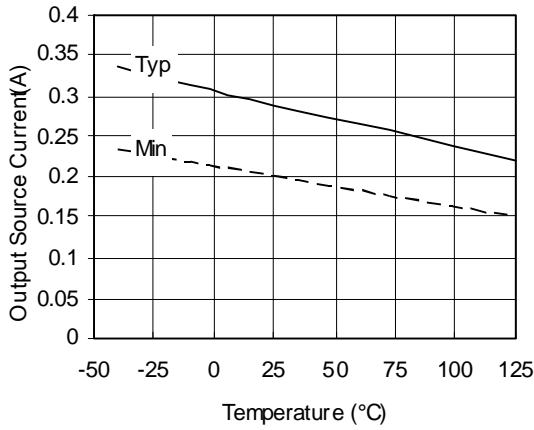

Figure 27A. Output Source Current vs. Temperature

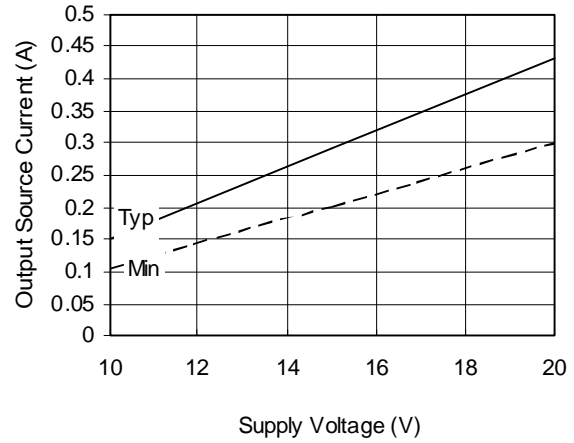

Figure 27B. Output Source Current vs. Voltage

IRS212(7, 71, 8, 81)(S)PbF

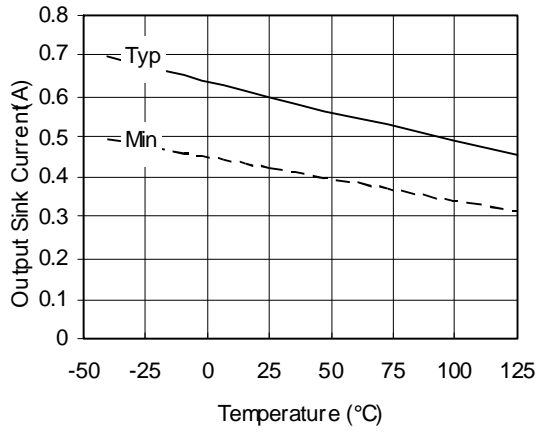

Figure 28A. Output Sink Current vs. Temperature

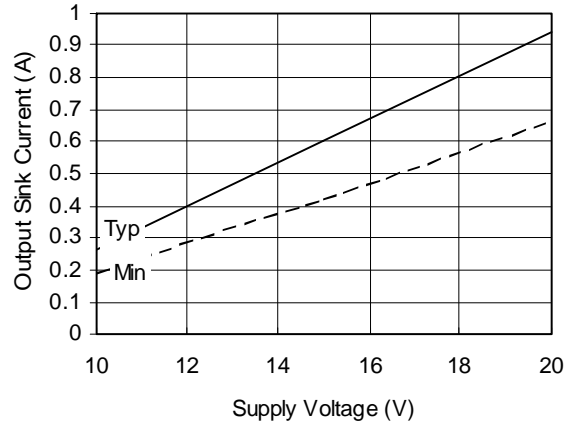
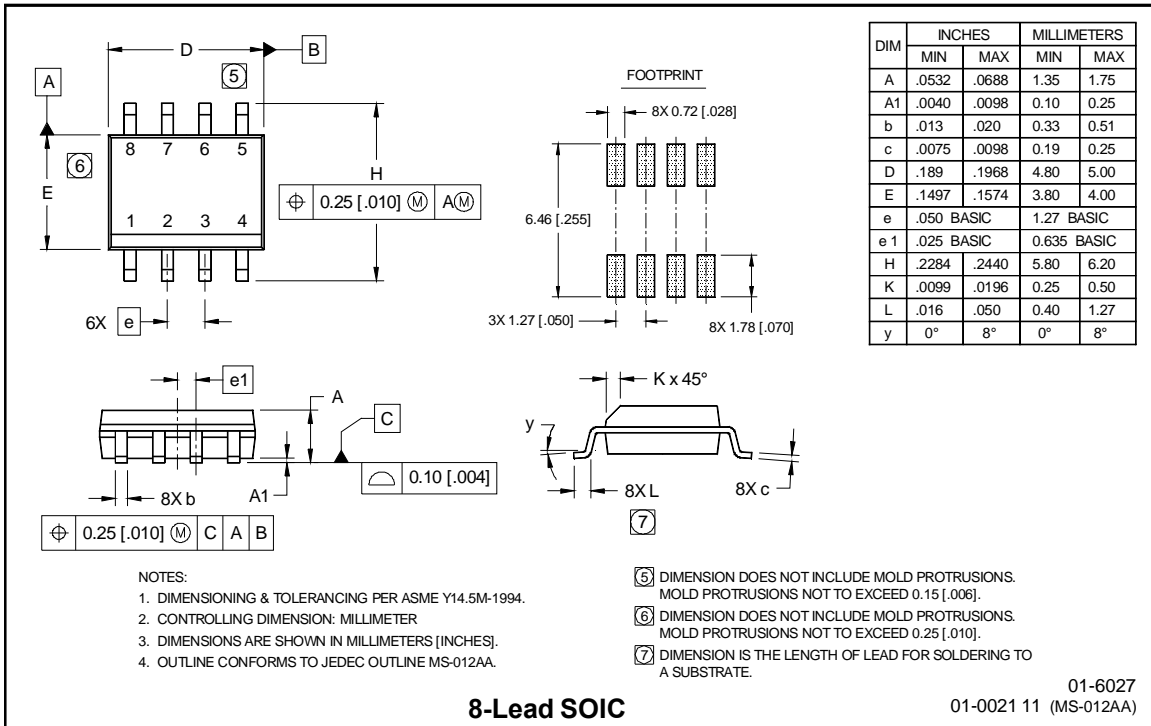
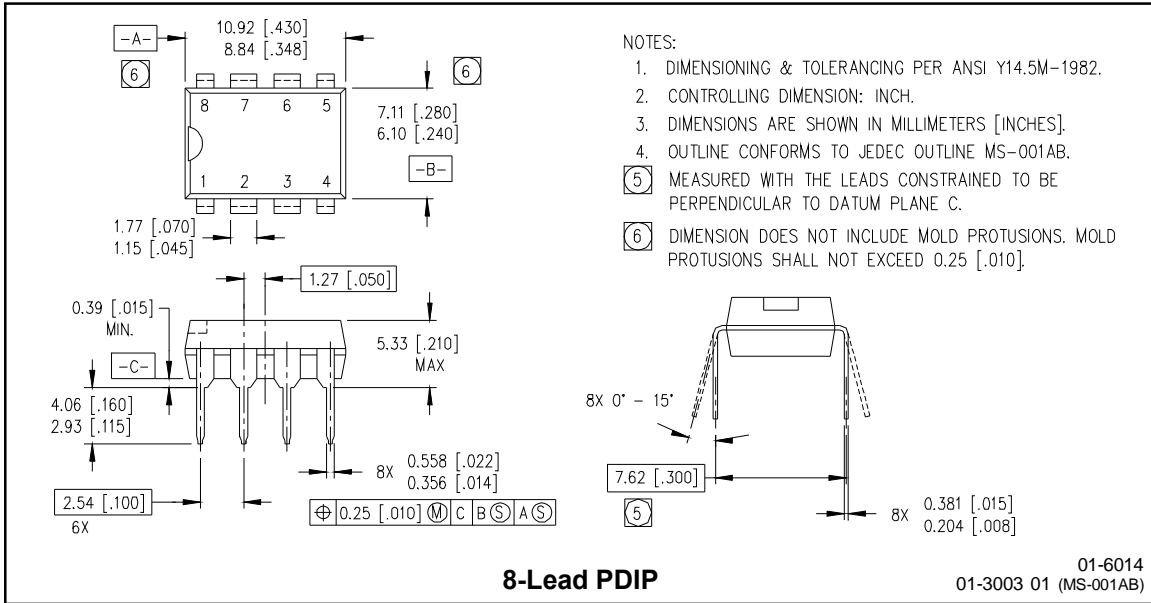
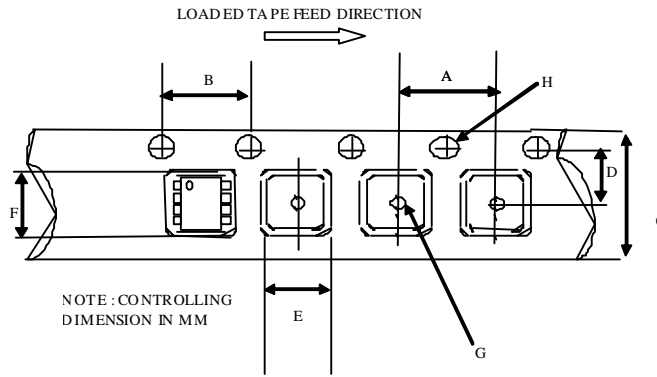

Figure 28B. Output Sink Current vs. Voltage

Case outlines



**Tape & Reel
 8-lead SOIC**



CARRIER TAPE DIMENSION FOR 8SOICN

Code	Metric		Imperial	
	Min	Max	Min	Max
A	7.90	8.10	0.311	0.318
B	3.90	4.10	0.153	0.161
C	11.70	12.30	0.46	0.484
D	5.45	5.55	0.214	0.218
E	6.30	6.50	0.248	0.255
F	5.10	5.30	0.200	0.208
G	1.50	n/a	0.059	n/a
H	1.50	1.60	0.059	0.062

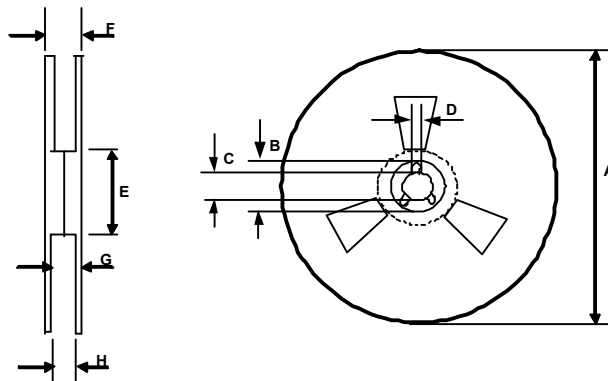

REEL DIMENSIONS FOR 8SOICN

Code	Metric		Imperial	
	Min	Max	Min	Max
A	329.60	330.25	12.976	13.001
B	20.95	21.45	0.824	0.844
C	12.80	13.20	0.503	0.519
D	1.95	2.45	0.767	0.096
E	98.00	102.00	3.858	4.015
F	n/a	18.40	n/a	0.724
G	14.50	17.10	0.570	0.673
H	12.40	14.40	0.488	0.566

LEADFREE PART MARKING INFORMATION

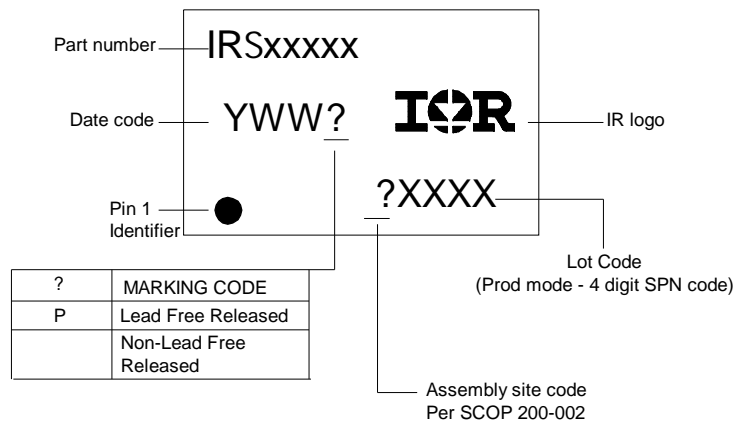

ORDER INFORMATION

8-Lead PDIP IRS2127PbF
 8-Lead PDIP IRS21271PbF
 8-Lead SOIC IRS2127SPbF
 8-Lead SOIC IRS21271SPbF
 8-Lead SOIC Tape & Reel IRS2127STRPbF
 8-Lead SOIC Tape & Reel IRS21271STRPbF

8-Lead PDIP IRS2128PbF
 8-Lead PDIP IRS21281PbF
 8-Lead SOIC IRS2128SPbF
 8-Lead SOIC IRS21281SPbF
 8-Lead SOIC Tape & Reel IRS2128STRPbF
 8-Lead SOIC Tape & Reel IRS21281STRPbF

Looking for pricing, stock, or lifecycle information?

Click below to explore more details on WIN SOURCE:

 [View IRS21281PBF on WIN SOURCE](#)

 [Infineon Technologies](#) Information

Optimize Your Supply Chain with WIN SOURCE Solutions

-  Global Sourcing Solution
-  Obsolete Management
-  Cost Control Management
-  Shortage Management
-  Alternative Solution
-  Excess Inventory Management