

Infineon® LITIX™ Linear

1 Channel High Side Current Source up to 500mA

TLE4242EJ

Infineon® LITIX™ Linear

1 Channel High Side Current Source up to 500mA

Datasheet

Rev. 1.10

2018-05-22

Automotive Power

Table of Contents

	Table of Contents	2
1	Overview	3
2	Block Diagram	4
3	Pin Configuration	5
3.1	Pin Assignment	5
3.2	Pin Definitions and Functions	5
4	General Product Characteristics	6
4.1	Absolute Maximum Ratings	6
4.2	Functional Range	7
4.3	Thermal Resistance	7
5	Product Description	8
5.1	Output Current Setting	8
5.2	Protection Functions	9
5.3	Electrical Characteristics	10
5.3.1	Typical Performance Characteristics	12
6	Application Information	14
6.1	Further Application Information	14
7	Package Outlines	15



1 Overview

Features

- Adjustable constant current up to 500 mA
- Wide input voltage range up to 42 V
- Low drop voltage
- Open load detection
- Over temperature protection
- Over load protection
- Integrated reverse polarity protection
- Wide temperature range -40 °C to 150 °C
- Green Product (RoHS compliant)
- AEC Qualified

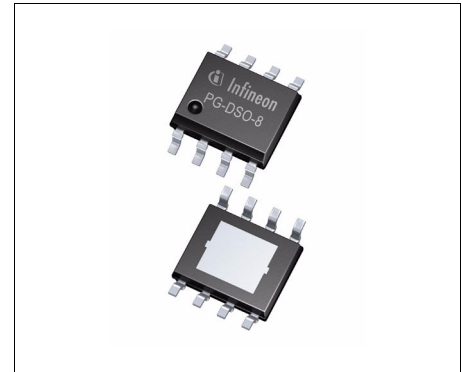
PG-DSO-8-27

Description

The TLE4242EJ is an integrated adjustable constant current source driving loads up to 500 mA. The output current level can be adjusted via an external resistor. The IC is designed to supply high power LEDs under the severe conditions of automotive applications resulting in constant brightness and extended LED lifetime. It is provided in the surface mounted PG-DSO-8-27 package. Protection circuits prevent damage to the device in case of over load, short circuit, reverse polarity and overheat. The connected LEDs are protected against reverse polarity as well as over voltages up to 45 V.

The integrated PWM input of the TLE4242EJ permits LED brightness regulation by pulse width modulation. Due to the high input impedance of the PWM input the LED driver can be operated as a protected high side switch.

Table 1 Product Summary

Parameter	Symbol	Values
Operating voltage	$V_I(\text{nom})$	4.5 V ... 42 V
Maximum output voltage	$V_Q(\text{max})$	40 V
Nominal output (load) current	$I_Q(\text{nom})$	135 mA
Minimum current limitation	$I_Q(\text{lim, min})$	476 mA
Current consumption in off mode	$I_{II}(\text{off, typ})$	0.1 μA

Type	Package	Marking
TLE4242EJ	PG-DSO-8-27	TLE4242

Pin Configuration

3 Pin Configuration

3.1 Pin Assignment

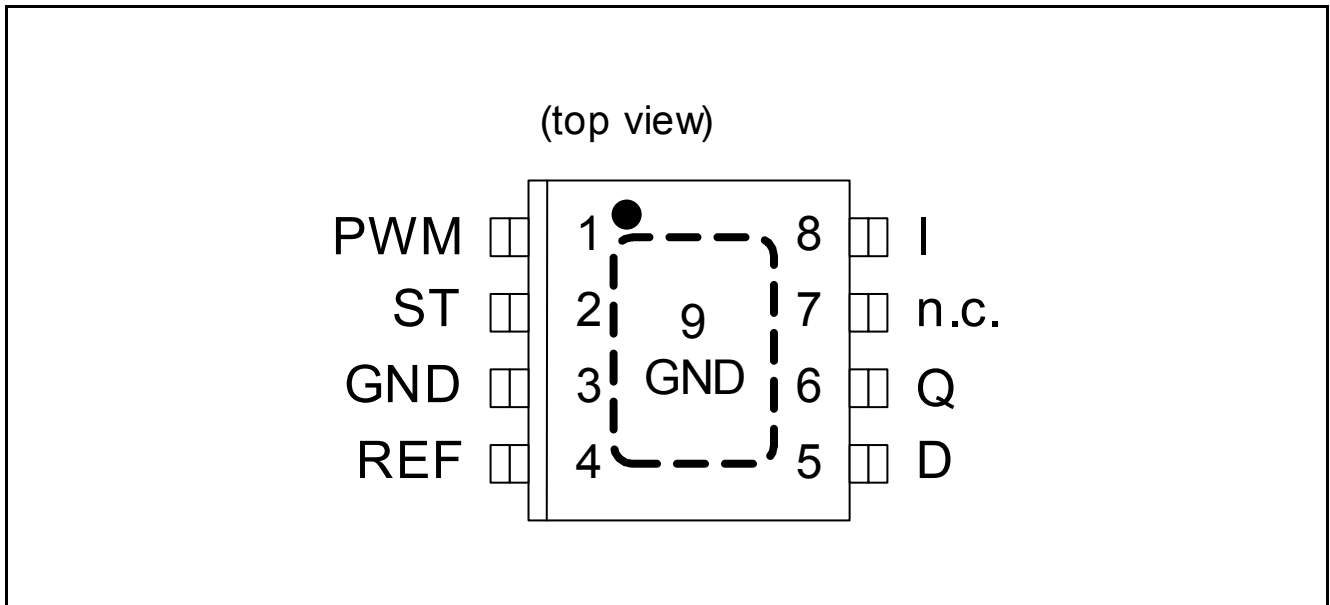

Figure 3-1 Pin Configuration

3.2 Pin Definitions and Functions

Pin	Symbol	Input/ Output	Function
1	PWM	I	Pulse Width Modulation Input; if not required, connect to I-pin ¹⁾
2	ST	O	Status Output; open collector output, connect to external pull-up resistor
3	GND	–	²⁾ Ground
4	REF	I	Reference Input; connect to shunt resistor
5	D	O	Status Delay; optional, connect to GND via an optional capacitor to extend the status reaction time. Leave open, if no delay is required.
6	Q	O	Output
8	I	I	Input; battery supply, connect a decoupling ceramic capacitor of at least 100 nF directly at the IC to ground
9	GND	–	²⁾ Exposed Pad; connect to GND in application

1) Please take care of different maximum ratings of I- and PWM-pins during circuit design.

2) Connect all GND-pins together.

General Product Characteristics

4 General Product Characteristics

4.1 Absolute Maximum Ratings

Table 4-1 Absolute Maximum Ratings¹⁾

$T_j = -40^\circ\text{C}$ to $+150^\circ\text{C}$; all voltages with respect to ground, positive current flowing into pin for input pins, positive currents flowing out of pin for output pins (unless otherwise specified)

Parameter	Symbol	Values			Unit	Note or Test Condition	Number
		Min.	Typ.	Max.			
Voltages							
Input voltage	V_I	-42	-	45	V	-	P_4.1.1
Output voltage	V_Q	-1	-	40	V	-	P_4.1.2
Status output voltage	V_{ST}	-0.3	-	40	V	-	P_4.1.3
Status delay voltage	V_D	-0.3	-	7	V	-	P_4.1.4
Reference input voltage	V_{REF}	-1	-	16	V	-	P_4.1.5
PWM input voltage	V_{PWM}	-40	-	40	V	-	P_4.1.6
Currents							
Input current	I_I	-	-	-	A	internally limited	P_4.1.7
Output current	I_Q	-	-	-	A	internally limited	P_4.1.8
Status output current	I_{ST}	-5	-	5	mA	-	P_4.1.9
Status delay current	I_D	-1	-	1	mA	in off-state 10 min	P_4.1.17
Reference input current	I_{REF}	-2	-	2	mA	-	P_4.1.10
PWM input current	I_{PWM}	-1	-	1	mA	-	P_4.1.11
Temperatures							
Junction Temperature	T_j	-40	-	150	$^\circ\text{C}$	-	P_4.1.12
Storage Temperature	T_{stg}	-55	-	150	$^\circ\text{C}$	-	P_4.1.13
ESD Susceptibility							
ESD Susceptibility	V_{ESD}	-2	-	2	kV	HBM ²⁾	P_4.1.14
ESD Susceptibility	V_{ESD}	-500	-	500	V	CDM ³⁾	P_4.1.15
ESD Susceptibility Pin 1, 4, 5, 8 (corner pins) to GND	$V_{ESD1,4,5,8}$	-750	-	750	V	CDM ³⁾	P_4.1.16

1) Not subject to production test, specified by design.

2) ESD susceptibility, HBM according to ANSI/ESDA/JEDEC JS001 (1.5k Ω , 100 pF)

3) ESD susceptibility, Charged Device Model "CDM" ESDA STM5.3.1 or ANSI/ESD S.5.3.1

General Product Characteristics

Notes

1. Stresses above the ones listed here may cause permanent damage to the device. Exposure to absolute maximum rating conditions for extended periods may affect device reliability.
2. Integrated protection functions are designed to prevent IC destruction under fault conditions described in the data sheet. Fault conditions are considered as “outside” normal operating range. Protection functions are not designed for continuous repetitive operation.

4.2 Functional Range

Table 4-2 Functional Range

Parameter	Symbol	Values			Unit	Note or Test Condition	Number
		Min.	Typ.	Max.			
Input voltage range	V_I	4.5	–	42	V	–	P_4.1.1
Status output voltage	V_{ST}	–	–	16	V	–	P_4.1.3
Status delay capacitance	C_D	0	–	2.2	μF	–	P_4.1.4
PWM voltage	V_{PWM}	0	–	40	V	–	P_4.1.6
Reference resistor	R_{REF}	0	–	1.8	Ω	–	P_4.1.10
Junction Temperature	T_j	-40	–	150	$^{\circ}\text{C}$	–	P_4.1.12

Note: Within the functional or operating range, the IC operates as described in the circuit description. The electrical characteristics are specified within the conditions given in the Electrical Characteristics table.

4.3 Thermal Resistance

Note: This thermal data was generated in accordance with JEDEC JESD51 standards. For more information, go to www.jedec.org.

Table 4-3 Thermal Resistance

Parameter	Symbol	Values			Unit	Note or Test Condition	Number
		Min.	Typ.	Max.			
Junction to Case ¹⁾	R_{thJC}	–	8	10	K/W	–	P_4.3.1
Junction to Ambient	R_{thJA}	–	39	–	K/W	²⁾ $T_a = 85^{\circ}\text{C}$	P_4.3.2

- 1) Not subject to production test, specified by design.
- 2) Specified R_{thJA} value is according to Jedec JESD51-2,-5,-7 at natural convection on FR4 2s2p board; The Product (Chip + Package) was simulated on a 76.2 × 114.3 × 1.5 mm board with 2 inner copper layers (2 × 70 mm Cu, 2 × 35 mm Cu). Where applicable a thermal via array under the exposed pad contacted the first inner copper layer.

Product Description

5 Product Description

The TLE4242EJ is an adjustable constant current source providing currents up to 500 mA. The product is optimized for automotive applications, but is suitable for industrial applications as well, where high currents are required.

5.1 Output Current Setting

An external shunt resistor in the ground path of the connected LEDs is used to sense the LED current. A regulation loop regulates the voltage drop at the shunt resistor R_{REF} on a constant level of typ. 175 mV. Selecting the appropriate shunt resistance allows to adjust the desired constant current level. The typical output current is calculated according to **Equation (5.1)**.

$$I_{Q(\text{typ})} = \frac{V_{REF}}{R_{REF}} \quad (5.1)$$

V_{REF} is the reference voltage with a typical value of 175 mV, details at **Reference voltage**. The equation applies in a range of $0.39 \Omega \leq R_{REF} \leq 1.8 \Omega$.

The output current is shown as a function of the reference resistance in **Chapter 5.3.1**. With the PWM input the LED brightness can be regulated via duty cycle. Also PWM = 0 V sets the TLE4242EJ in sleep mode resulting in a very low current consumption $I_{I(\text{off})}$ **Current consumption at Input-pin during off-state**. Due to the high impedance of the PWM input the PWM pin can also be used as an enable input.

The application example in **Figure 6-1** shows a typical application with the TLE4242EJ LED driver. The three LEDs are driven with an adequate supply current adjusted by the resistor R_{REF} . Thus brightness variations due to forward voltage spread of the LEDs are prevented. The luminosity spread arising from the LED production process can be compensated via software by an appropriate duty cycle applied to the PWM pin. Therefore, selection of the LEDs to forward voltage as well as to luminosity classes can be spared. The minimum supply voltage for the application is the sum of the LED forward voltages, the TLE4242EJ drop voltage **Minimum drop voltage $V_{dr} = V_I - V_Q$** and the max. voltage drop at the shunt resistor R_{REF} of $V_{REF(\text{max})}$ according to **Reference voltage**.

The status output of the LED driver (ST) detects an open load condition enabling to supervise correct LED function. A LED failure is detected, if the voltage drop at the shunt resistor R_{REF} falls below typ. 25 mV. In this case the status output pin ST is set low after a delay time, which is adjustable via an optional capacitor connected to the pin D.

The functionality of the status ST and PWM-pin as well as their timings are shown in **Figure 5-1**. The pull up resistor value at the ST-pin is recommended with $R_{ST_pu} \geq 4.7 \text{ k}\Omega$. The status delay can be adjusted via the capacitor connected to the timing pin D. The delay time $t_{ST(\text{HL})}$ and $t_{ST(\text{LH})}$ scales linearly with the capacitance C_D :

$$t_{ST(\text{HL}, \text{typ})} = \frac{C_D}{47\text{nF}} \cdot 10\text{ms} \quad (5.2)$$

$$t_{ST(\text{LH}, \text{typ})} = \frac{C_D}{47\text{nF}} \cdot 10\mu\text{s} \quad (5.3)$$

Product Description

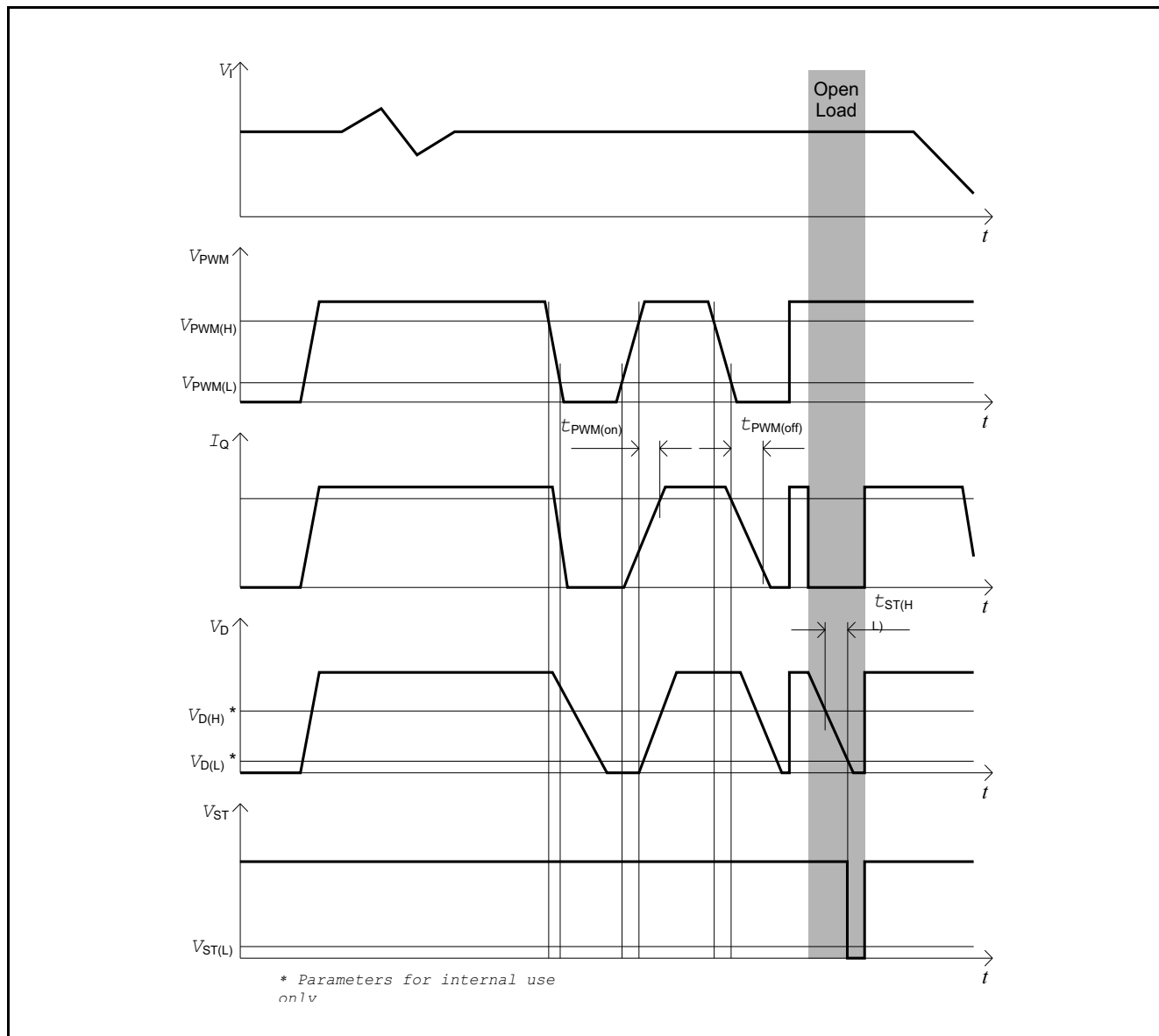

Figure 5-1 Function and Timing Diagram

5.2 Protection Functions

The TLE4242EJ provides embedded protection functions, which are designed to prevent IC destruction under fault conditions described in the data sheet. Fault conditions are considered as “outside” normal operating range. Protection functions are neither designed for continuous nor for repetitive operation.

The following protection functions are embedded:

- Over temperature protection realized by over temperature switch off (see [Figure 5-2](#))
- Over load protection realized by output current limitation and over temperature protection
- Integrated reverse polarity protection

Product Description

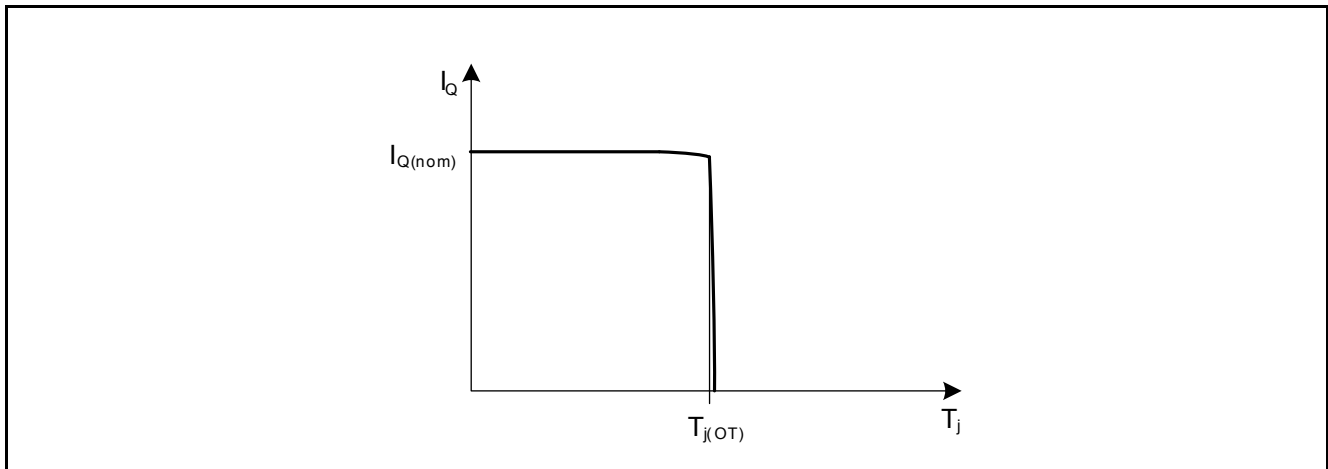

Figure 5-2 Over Temperature Protection

5.3 Electrical Characteristics

Table 5-1 Electrical Characteristics

$V_I = 13.5\text{ V}$, $R_{REF} = 0.47\ \Omega$, $V_{PWM} = 5.0\text{ V}$, $T_j = -40^\circ\text{C}$ to $+150^\circ\text{C}$, all voltages with respect to ground, positive current flowing into pin for input pins, positive currents flowing out of pin for output pins (unless otherwise specified)

Parameter	Symbol	Values			Unit	Note or Test Condition	Number
		Min.	Typ.	Max.			
Current consumption at Input-pin during off-state	$I_{I(off)}$	–	0.1	2	μA	¹⁾ $T_j = 85^\circ\text{C}$, $V_{PWM} = 0.0\text{ V}$	P_5.3.1
Operational current consumption in on-state $I_{op} = I_I - I_Q$	$I_{op(on)}$	–	12	22	mA	$V_Q = 6.6\text{ V}$	P_5.3.2

Output

Output current	I_Q	350	373	395	mA	²⁾ $V_Q - V_{REF} = 6.6\text{ V}$	P_5.3.3
Output current	I_Q	165	175	185	mA	$V_Q - V_{REF} = 6.6\text{ V}$, $R_{REF} = 1.0\ \Omega$	P_5.3.4
Output current	I_Q	425	451	476	mA	$V_Q - V_{REF} = 6.6\text{ V}$, $R_{REF} = 0.39\ \Omega$	P_5.3.5
Output current	I_Q	357	384	410	mA	$5.4\text{ V} \leq (V_Q - V_{REF}) \leq 7.8\text{ V}$; $9\text{ V} \leq V_I \leq 16\text{ V}$	P_5.3.6
Output current limit	$I_{Q(lim)}$	476	600	–	mA	$R_{REF} = 0\ \Omega$	P_5.3.7
Minimum drop voltage $V_{dr} = V_I - V_Q$	V_{dr}	–	0.35	0.7	V	$I_Q = 300\text{ mA}$	P_5.3.8

PWM Input

PWM high level	$V_{PWM(H)}$	2.6	–	–	V	–	P_5.3.9
----------------	--------------	-----	---	---	------------	---	---------

Product Description

Table 5-1 Electrical Characteristics (continued)

$V_I = 13.5\text{ V}$, $R_{REF} = 0.47\ \Omega$, $V_{PWM} = 5.0\text{ V}$, $T_J = -40^\circ\text{C}$ to $+150^\circ\text{C}$, all voltages with respect to ground, positive current flowing into pin for input pins, positive currents flowing out of pin for output pins (unless otherwise specified)

Parameter	Symbol	Values			Unit	Note or Test Condition	Number
		Min.	Typ.	Max.			
PWM low level	$V_{PWM(L)}$	–	–	0.7	V	–	P_5.3.10
PWM input current high level	$I_{PWM(H)}$	–	–	10	μA	$V_{PWM} = 5.0\text{ V}$	P_5.3.11
PWM input current low level	$I_{PWM(L)}$	-1	–	1	μA	$V_{PWM} = 0.0\text{ V}$	P_5.3.12
Turn on delay time	$t_{PWM(on)}$	0	15	40	μs	70% of V_{REF}/R_{REF} , see Figure 5-1	P_5.3.13
Turn off delay time	$t_{PWM(off)}$	0	15	40	μs	30% of V_{REF}/R_{REF} , see Figure 5-1	P_5.3.14

Reference

Reference voltage	V_{REF}	165	175	185	mV	$0.39\ \Omega \leq R_{REF} \leq 1.0\ \Omega$ $V_Q - V_{REF} = 6.6\text{ V}$	P_5.3.15
Reference input current	I_{REF}	-1	0.1	1	μA	$V_{REF} = 180\text{ mV}$	P_5.3.16

Status Output

Lower status switching threshold	$V_{IQ(L)}$	15	25	–	mV	–	P_5.3.17
Upper status switching threshold	$V_{IQ(H)}$	–	30	40	mV	–	P_5.3.18
Status low voltage	$V_{ST(L)}$	–	–	0.4	V	$I_{ST} = 1.5\text{ mA}$	P_5.3.19
Leakage current	$I_{ST(leak)}$	–	–	5	μA	$V_{ST} = 5.0\text{ V}$	P_5.3.20

Status Delay

Status reaction delay	$t_{ST(HL)}$	6	10	14	ms	¹⁾ $C_D = 47\text{ nF}$ ST H → L	P_5.3.21
Status release delay	$t_{ST(LH)}$	–	10	20	μs	¹⁾ $C_D = 47\text{ nF}$ ST L → H	P_5.3.22

Protection

Over temperature protection threshold	$T_{j(OT)}$	150	–	–	$^\circ\text{C}$	¹⁾	P_5.3.23
Reverse output current	$-I_{Q(rev)}$	–	–	2	μA	¹⁾ $V_I = -16\text{ V}$ Output load: LED with break down voltage $< -0.6\text{ V}$	P_5.3.27

1) Not subject to production test, specified by design

2) $V_Q - V_{REF}$ equals the forward voltage sum of the connected LEDs, see [Figure 6-1](#)

Product Description

5.3.1 Typical Performance Characteristics

Data below show the behavior of a typical device.

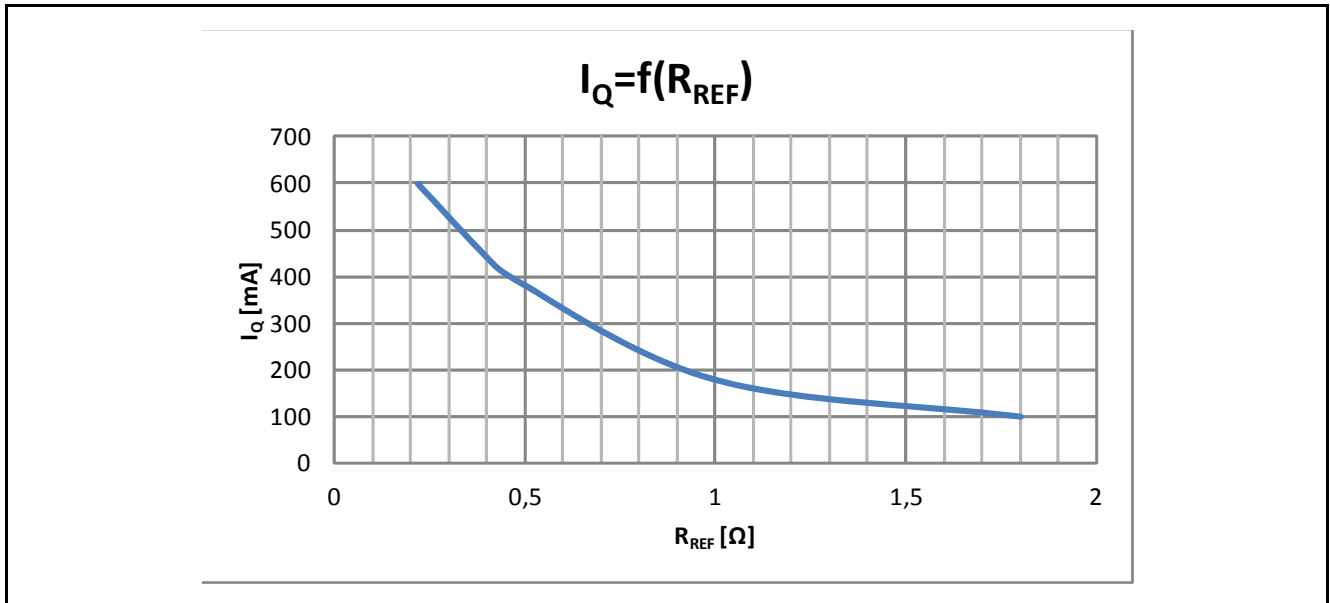

Figure 5-3 Output Current I_Q versus Reference Resistor R_{REF} with $V_Q = 6.6 V$

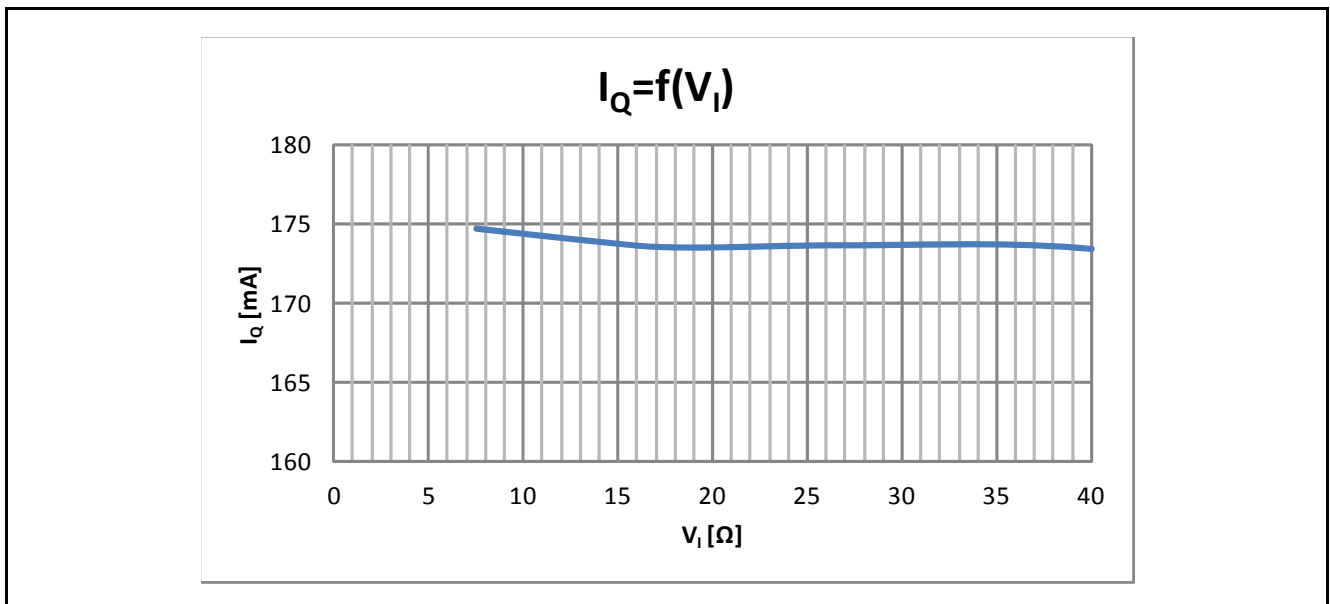

Figure 5-4 Output Current I_Q versus Supply Voltage V_I with $V_Q - V_{REF} = 6.6 V$ and $R_{REF} = 1 \Omega$

Product Description

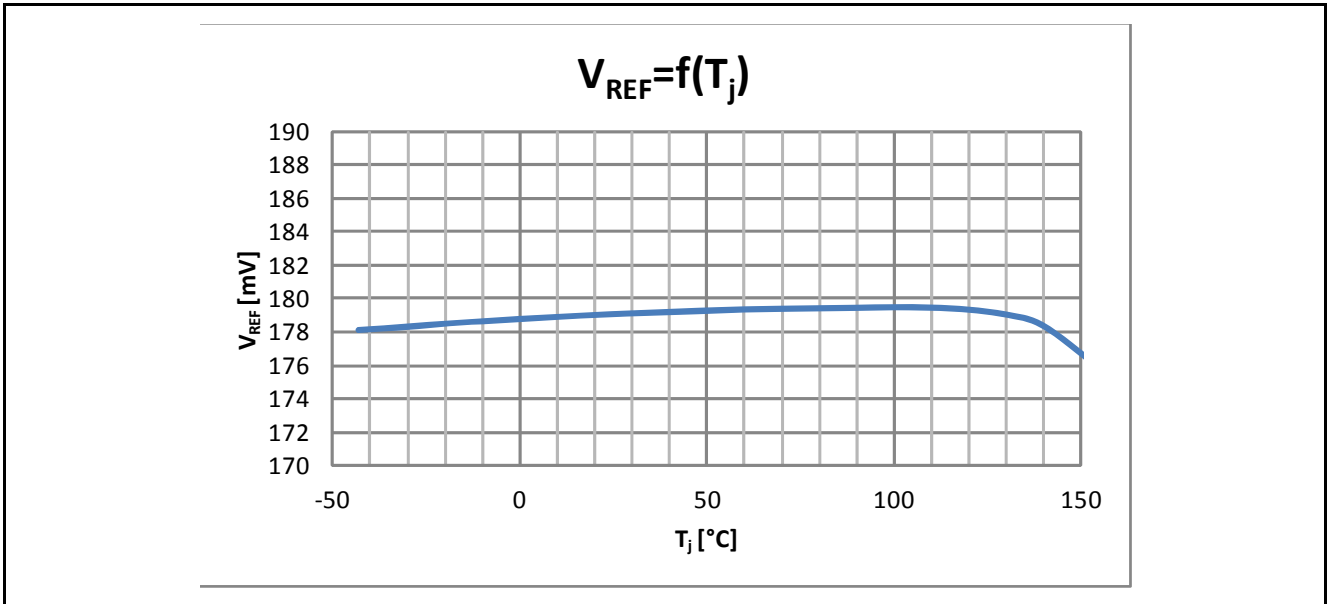

Figure 5-5 Reference Voltage V_{REF} versus Junction Temperature T_j

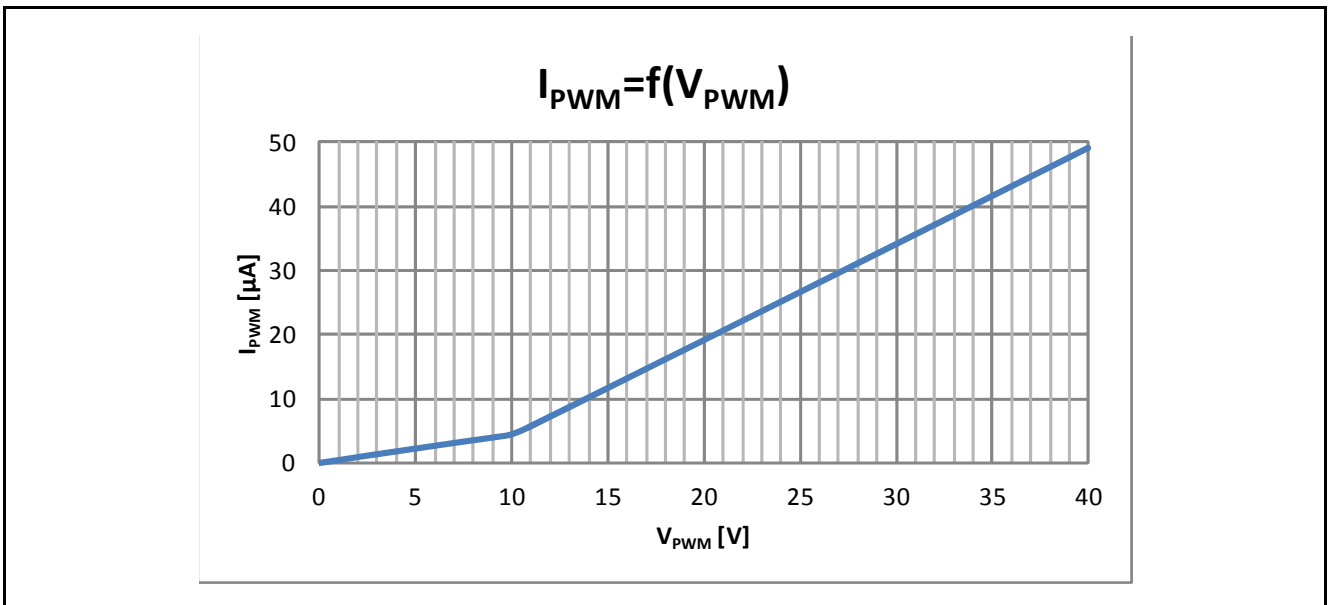

Figure 5-6 PWM Pin Input Current I_{PWM} versus PWM Voltage V_{PWM} at $T_j = 25^\circ\text{C}$ and $V_1 = 13.5\text{ V}$

6 Application Information

Note: The following information is given as a hint for the implementation of the device only and shall not be regarded as a description or warranty of a certain functionality, condition or quality of the device.

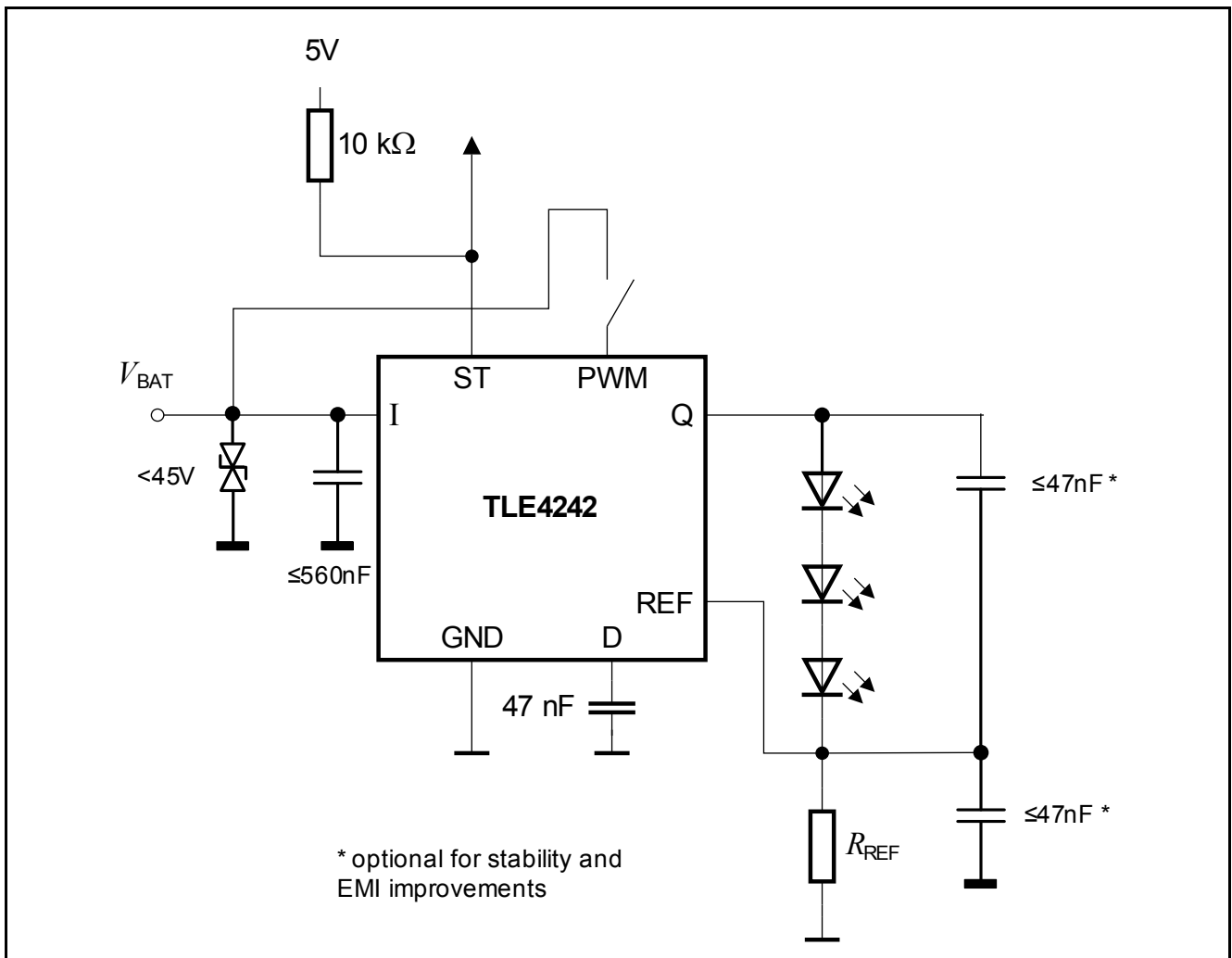

Figure 6-1 Application Diagram

Note: This is a very simplified example of an application circuit. The function must be verified in the real application.

6.1 Further Application Information

- Please contact us for information regarding the FMEA pin
- Existing App. Note: LED Driving Concepts and Infineon Basic LED Drivers
- For further information you may contact <http://www.infineon.com/>

Package Outlines

7 Package Outlines

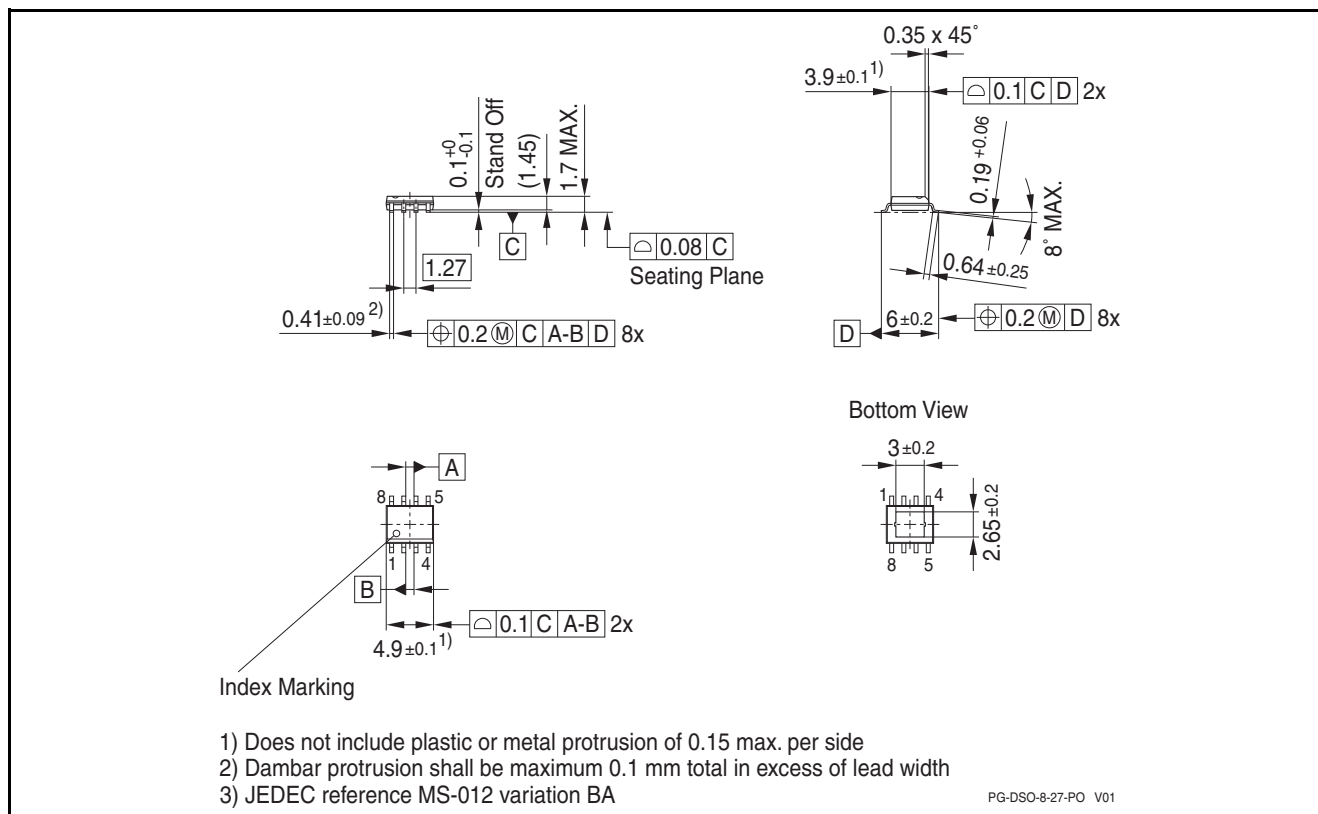

Figure 7-1 PG-DSO-8-27 (Please Insert Package Long Name!)

Green Product (RoHS compliant)

To meet the world-wide customer requirements for environmentally friendly products and to be compliant with government regulations the device is available as a green product. Green products are RoHS-Compliant (i.e Pb-free finish on leads and suitable for Pb-free soldering according to IPC/JEDEC J-STD-020).

For further information on alternative packages, please visit our website:
<http://www.infineon.com/packages>.

Dimensions in mm

Revision History		Responsible	Date
Subjects (major changes since previous revision)			
Rev. 1.10, 2018-05-22			
Figure 2-1	Updated block diagram		2018-05-22
Revision 1.00, 2014-02-05			
	Data Sheet for TLE4242EJ		2014-02-05

Trademarks

All referenced product or service names and trademarks are the property of their respective owners

www.infineon.com

Edition 2018-05-22

Published by

Infineon Technologies AG

81726 Munich, Germany

© 2014 Infineon Technologies AG.

All Rights Reserved.

Do you have a question about any aspect of this document?

Email: erratum@infineon.com

**Document reference
TLE4242EJ**

Legal Disclaimer

The information given in this document shall in no event be regarded as a guarantee of conditions or characteristics. With respect to any examples or hints given herein, any typical values stated herein and/or any information regarding the application of the device, Infineon Technologies hereby disclaims any and all warranties and liabilities of any kind, including without limitation, warranties of non-infringement of intellectual property rights of any third party.

Information

For further information on technology, delivery terms and conditions and prices, please contact the nearest Infineon Technologies Office (www.infineon.com).

Warnings

Due to technical requirements, components may contain dangerous substances. For information on the types in question, please contact the nearest Infineon Technologies Office. Infineon Technologies components may be used in life-support devices or systems only with the express written approval of Infineon Technologies, if a failure of such components can reasonably be expected to cause the failure of that life-support device or system or to affect the safety or effectiveness of that device or system. Life support devices or systems are intended to be implanted in the human body or to support and/or maintain and sustain and/or protect human life. If they fail, it is reasonable to assume that the health of the user or other persons may be endangered.

Looking for pricing, stock, or lifecycle information?

Click below to explore more details on WIN SOURCE:

- ⊖ [View TLE4242EJXUMA1 on WIN SOURCE](#)
- ⊖ [Infineon Technologies Information](#)

Optimize Your Supply Chain with WIN SOURCE Solutions

- ✓ Global Sourcing Solution
- ✓ Obsolete Management
- ✓ Cost Control Management
- ✓ Shortage Management
- ✓ Alternative Solution
- ✓ Excess Inventory Management