



**THE DATASHEET OF
P0080SARP**



SIDActo[®] Protection Thyristor Series - DO-214



Agency Approvals

Agency	Agency File Number
	E133083

Schematic Symbol

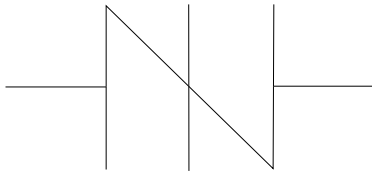

Description

SIDActo[®] Series DO-214AA are designed to protect baseband equipment such as modems, line cards, CPE and DSL from damaging overvoltage transients.

The series provides a surface mount solution that enables equipment to comply with global regulatory standards.

Features and Benefits

- Low voltage overshoot
- Low on-state voltage
- Does not degrade in capability after multiple surge events within limit.
- Low capacitance
- Fails short circuit when surged in excess of ratings
- Pb-free E3 means 2nd level interconnect is Pb-free and the terminal finish material is tin(Sn) (IPC/JEDEC J-STD-609A.01)
- UL Recognized to UL 497B as an Isolated Loop Circuit Protector

Applicable Global Standards

- TIA-968-A
- TIA-968-B
- ITU K.20/21 Enhanced Level*
- ITU K.20/21 Basic Level
- GR 1089 Inter-building*
- GR 1089 Intra-building
- IEC 61000-4-5 2nd Edition
- YD/T 1082
- YD/T 993
- YD/T 950

*A/B-rated parts require series resistance

Electrical Characteristics

Part Number	Marking	V_{DRM} @ $I_{DRM} = 5\mu A$	V_S @ 100V/ μs	I_H	I_S	I_T	V_T @ $I_T = 2.2$ Amps	Capacitance @ 1MHz, 2V bias	
		V min	V max	mA min	mA max	A max	V max	pF min	pF max
P0080SALRP	P-8A	6	25	50	800	2.2	4	20	35
P1200SALRP	P12A	100	130	120	800	2.2	4	15	40
P2000SALRP	P20A	180	220	120	800	2.2	4	15	35
P0220SALRP	P22A	15	32	50	800	2.2	4	20	40
P2500SALRP	P25A	230	290	120	800	2.2	4	15	35
P0300SALRP	P03A	25	40	50	800	2.2	4	15	40
P0640SALRP	P06A	58	77	150	800	2.2	4	15	40
P0720SALRP	P07A	65	88	150	800	2.2	4	15	40
P0900SALRP	P09A	75	98	150	800	2.2	4	15	40
P1100SALRP	P11A	90	130	150	800	2.2	4	15	40
P1300SALRP	P13A	120	160	150	800	2.2	4	15	40
P1500SALRP	P15A	140	180	150	800	2.2	4	15	40
P1800SALRP	P18A	170	220	150	800	2.2	4	15	35
P2100SALRP	P21A	180	240	150	800	2.2	4	15	35
P2300SALRP	P23A	190	260	150	800	2.2	4	15	35
P2600SALRP	P26A	220	300	150	800	2.2	4	15	35
P3100SALRP	P31A	275	350	150	800	2.2	4	15	35
P3500SALRP	P35A	320	400	150	800	2.2	4	15	35
P0080SBLRP	P-8B	6	25	50	800	2.2	4	20	50
P0220SBLRP	P22B	15	32	50	800	2.2	4	20	50
P0300SBLRP	P03B	25	40	50	800	2.2	4	15	50
P0640SBLRP	P06B	58	77	150	800	2.2	4	20	50
P0720SBLRP	P07B	65	88	150	800	2.2	4	20	50

Electrical Parameters (continued)

Part Number	Marking	V_{DRM} @ $I_{DRM} = 5\mu A$	V_S @ 100V/ μs	I_H	I_S	I_T	V_T @ $I_T = 2.2$ Amps	Capacitance @ 1MHz, 2V bias	
		V min	V max	mA min	mA max	A max	V max	pF min	pF max
P0900SBLRP	P09B	75	98	150	800	2.2	4	20	50
P1100SBLRP	P11B	90	130	150	800	2.2	4	20	50
P1200SBLRP	P12B	100	130	120	800	2.2	4	20	50
P1300SBLRP	P13B	120	160	150	800	2.2	4	20	50
P1500SBLRP	P15B	140	180	150	800	2.2	4	20	50
P1800SBLRP	P18B	170	220	150	800	2.2	4	20	50
P2000SBLRP	P20B	180	220	120	800	2.2	4	20	50
P2100SBLRP	P21B	180	240	150	800	2.2	4	20	35
P2300SBLRP	P23B	190	260	150	800	2.2	4	20	50
P2500SBLRP	P25B	230	290	120	800	2.2	4	20	50
P2600SBLRP	P26B	220	300	150	800	2.2	4	20	35
P3100SBLRP	P31B	275	350	150	800	2.2	4	20	35
P3500SBLRP	P35B	320	400	150	800	2.2	4	20	35
P4500SBLRP	P45B	400	530	150	800	2.2	4	20	50
P0080SCLRP	P-8C	6	25	50	800	2.2	4	25	70
P0220SCLRP	P22C	15	32	50	800	2.2	4	25	70
P0300SCLRP	P03C	25	40	50	800	2.2	4	20	50
P0640SCLRP	P06C	58	77	150	800	2.2	4	45	100
P0720SCLRP	P07C	65	88	150	800	2.2	4	45	100
P0900SCLRP	P09C	75	98	150	800	2.2	4	45	100
P1100SCLRP	P11C	90	130	150	800	2.2	4	45	90
P1200SCLRP	P12C	100	130	120	800	2.2	4	20	35
P1300SCLRP	P13C	120	160	150	800	2.2	4	40	85
P1500SCLRP	P15C	140	180	150	800	2.2	4	25	70
P1800SCLRP	P18C	170	220	150	800	2.2	4	25	70
P2000SCLRP	P20C	180	220	120	800	2.2	4	25	35
P2100SCLRP	P21C	180	240	150	800	2.2	4	25	70
P2300SCLRP	P23C	190	260	150	800	2.2	4	25	70
P2500SCLRP	P25C	230	290	120	800	2.2	4	30	70
P2600SCLRP	P26C	220	300	150	800	2.2	4	30	70
P3100SCLRP	P31C	275	350	150	800	2.2	4	30	70
P3500SCLRP	P35C	320	400	150	800	2.2	4	25	65
P4500SCLRP	P45C	400	530	150	800	2.2	4	25	65

Notes:

- Absolute maximum ratings measured at $T_A = 25^\circ C$ (unless otherwise noted).
- Components are bi-directional.

Surge Ratings

Series	I_{PP}									I_{TSM} 50/60 Hz	di/dt
	0.2/310 ¹ 0.5/700 ²	2/10 ¹ 2/10 ²	8/20 ¹ 1.2/50 ²	10/160 ¹ 10/160 ²	10/560 ¹ 10/560 ²	5/320 ¹ 9/720 ²	10/360 ¹ 10/360 ²	10/1000 ¹ 10/1000 ²	5/310 ¹ 10/700 ²		
	A min	A min	A min	A min	A min	A min	A min	A min	A min		
A	20	150	150	90	50	75	75	45	75	25	500
B	25	250	250	150	100	100	125	80	100	30	500
C	50	500	400	200	150	200	175	100	200	35	500

Notes:

- Current waveform in μs
 - Voltage waveform in μs
- Peak pulse current rating (I_{PP}) is repetitive and guaranteed for the life of the product.
 - I_{PP} ratings applicable over temperature range of $-40^\circ C$ to $+85^\circ C$
 - The component must initially be in thermal equilibrium with $-40^\circ C \leq T_J \leq +150^\circ C$

Thermal Considerations

Package	Symbol	Parameter	Value	Unit
DO-214AA 	T_J	Operating Junction Temperature Range	-40 to +150	°C
	T_S	Storage Temperature Range	-65 to +150	°C
	$R_{\theta JA}$	Thermal Resistance: Junction to Ambient	90	°C/W

V-I Characteristics



$t_r \times t_d$ Pulse Waveform

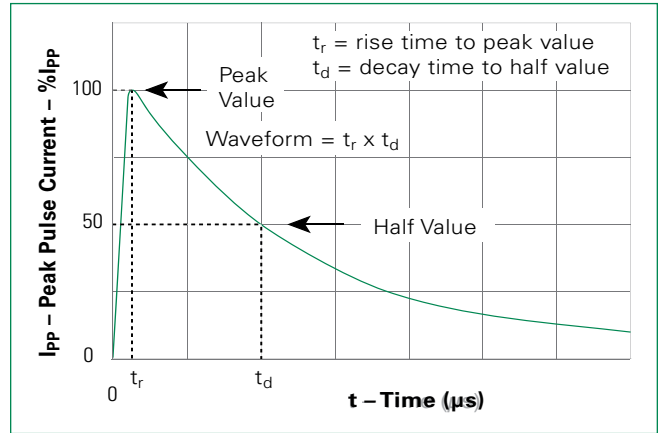

Normalized V_S Change vs. Junction Temperature

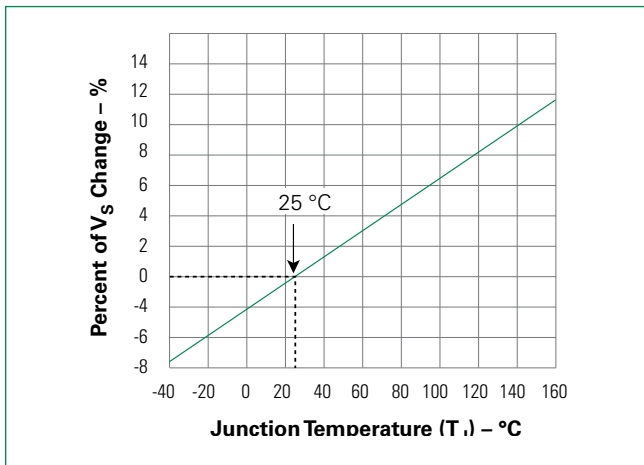

Normalized DC Holding Current vs. Case Temperature

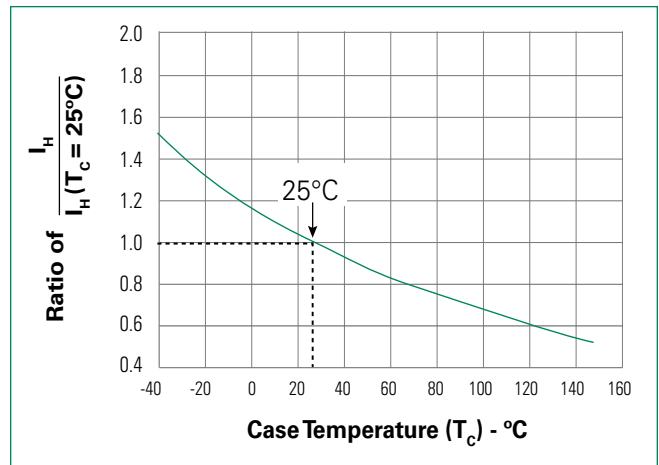

Soldering Parameters

Reflow Condition		Pb-Free assembly
Pre Heat	- Temperature Min ($T_{s(min)}$)	+150°C
	- Temperature Max ($T_{s(max)}$)	+200°C
	- Time (Min to Max) (t_s)	60-180 secs.
Average ramp up rate (Liquidus Temp (T_L) to peak)		3°C/sec. Max.
$T_{s(max)}$ to T_L - Ramp-up Rate		3°C/sec. Max.
Reflow	- Temperature (T_L) (Liquidus)	+217°C
	- Temperature (t_L)	60-150 secs.
Peak Temp (T_p)		+260(+0/-5)°C
Time within 5°C of actual Peak Temp (t_p)		30 secs. Max.
Ramp-down Rate		6°C/sec. Max.
Time 25°C to Peak Temp (T_p)		8 min. Max.
Do not exceed		+260°C

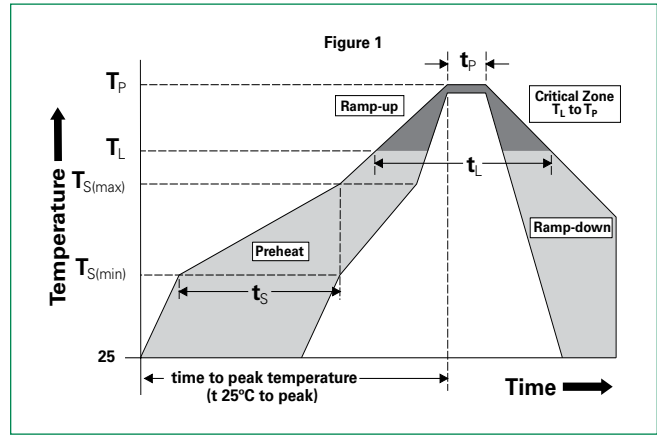

Physical Specifications

Lead Material	Copper Alloy
Terminal Finish	100% Matte-Tin Plated
Body Material	UL recognized epoxy meeting flammability classification V-0

Environmental Specifications

High Temp Voltage Blocking	80% Rated V_{DRM} (V_{AC} Peak) +125°C or +150°C, 504 or 1008 hrs. MIL-STD-750 (Method 1040) JEDEC, JESD22-A-101
Temp Cycling	-65°C to +150°C, 15 min. dwell, 10 up to 100 cycles. MIL-STD-750 (Method 1051) EIA/JEDEC, JESD22-A104
Biased Temp & Humidity	52 V_{DC} (+85°C) 85% RH, 504 up to 1008 hrs. EIA/JEDEC, JESD22-A-101
High Temp Storage	+150°C 1008 hrs. MIL-STD-750 (Method 1031) JEDEC, JESD22-A-101
Low Temp Storage	-65°C, 1008 hrs.
Thermal Shock	0°C to +100°C, 5 min. dwell, 10 sec. transfer, 10 cycles. MIL-STD-750 (Method 1056) JEDEC, JESD22-A-106
Autoclave (Pressure Cooker Test)	+121°C, 100% RH, 2atm, 24 up to 168 hrs. EIA/JEDEC, JESD22-A-102
Resistance to Solder Heat	+260°C, 30 secs. MIL-STD-750 (Method 2031)
Moisture Sensitivity Level	85% RH, +85°C, 168 hrs., 3 reflow cycles (+260°C Peak). JEDEC-J-STD-020, Level 1

Part Numbering

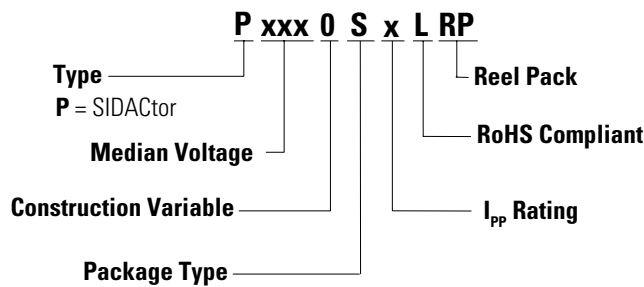

Part Marking

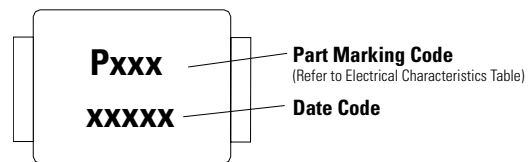

Dimensions — DO-214AA

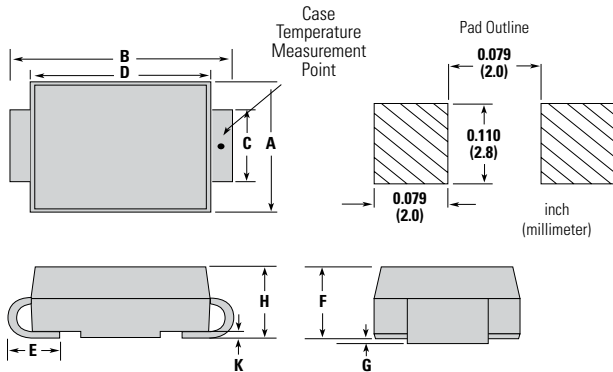

Dimensions	Inches		Millimeters	
	Min	Max	Min	Max
A	0.130	0.156	3.30	3.95
B	0.201	0.220	5.10	5.60
C	0.077	0.087	1.95	2.20
D	0.159	0.181	4.05	4.60
E	0.030	0.063	0.75	1.60
F	0.075	0.096	1.90	2.45
G	0.002	0.008	0.05	0.20
H	0.077	0.104	1.95	2.65
K	0.006	0.016	0.15	0.41

Packing Options

Package Type	Description	Quantity	Added Suffix	Industry Standard
S	DO-214AA Tape & Reel Pack	2500	RP	EIA-481-D

Tape and Reel Specification — DO-214AA

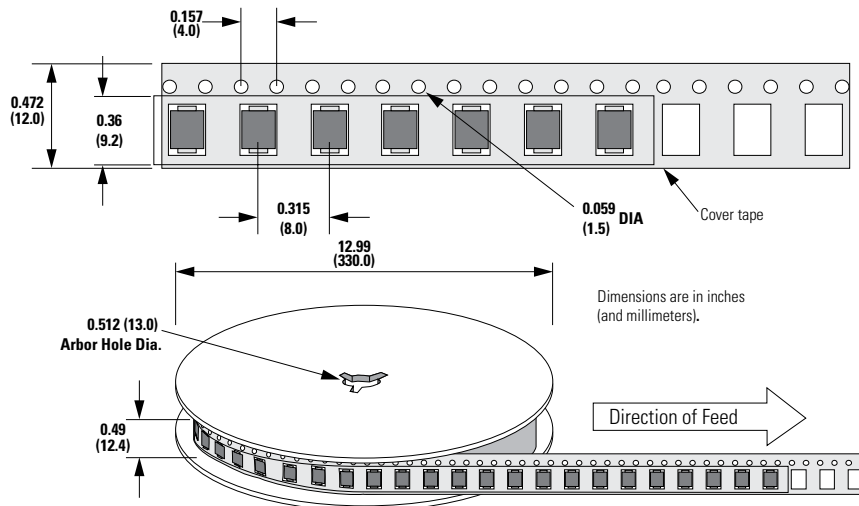

Looking for pricing, stock, or lifecycle information?

Click below to explore more details on WIN SOURCE:

 [View P0080SARP on WIN SOURCE](#)

 [Littelfuse Inc. Information](#)

Optimize Your Supply Chain with WIN SOURCE Solutions

-  Global Sourcing Solution
-  Obsolete Management
-  Cost Control Management
-  Shortage Management
-  Alternative Solution
-  Excess Inventory Management