



THE DATASHEET OF LMX358AKA-T





Single/Dual/Quad, General-Purpose, Low-Voltage, Rail-to-Rail Output Op Amps

General Description

The LMX321/LMX358/LMX324 are single/dual/quad, low-cost, low-voltage, pin-to-pin compatible upgrades to the LMV321/LMV358/LMV324 family of general purpose op amps. These devices offer rail-to-rail outputs and an input common-mode range that extends below ground. These op amps draw only 105µA of quiescent current per amplifier, operate from a single +2.3V to +7V supply, and drive 2kΩ resistive loads to within 40mV of either rail. The LMX321/LMX358/LMX324 are unity-gain stable with a 1.3MHz gain-bandwidth product capable of driving capacitive loads up to 400pF. The combination of low voltage, low cost, and small package size makes these amplifiers ideal for portable/battery-powered equipment.

The LMX321 single op amp is available in ultra-small 5-pin SC70 and space-saving 5-pin SOT23 packages. The LMX358 dual op amp is available in the tiny 8-pin SOT23 or the 8-pin µMAX® package. The LMX324 quad op amp is available in 14-pin TSSOP and SO packages.

Applications

Cellular Phones
Laptops
Low-Power, Low-Voltage Applications
Portable/Battery-Powered Equipment
Cordless Phones
Active Filters

Features

- ◆ Upgrade to LMV321/LMV358/LMV324 Family
- ◆ Single +2.3V to +7V Supply Voltage Range
- ◆ Available in Space-Saving Packages
 - 5-Pin SC70 (LMX321)
 - 8-Pin SOT23 (LMX358)
 - 14-Pin TSSOP (LMX324)
- ◆ 1.3MHz Gain-Bandwidth Product
- ◆ 105µA Quiescent Current per Amplifier (V_{CC} = +2.7V)
- ◆ No Phase Reversal for Overdriven Inputs
- ◆ No Crossover Distortion
- ◆ Rail-to-Rail Output Swing
- ◆ Input Common-Mode Voltage Range: V_{EE} - 0.2V to V_{CC} - 0.8V
- ◆ Drives 2kΩ Resistive Loads

Ordering Information

PART	TEMP RANGE	PIN-PACKAGE	PKG CODE
LMX321AXK-T	-40°C to +125°C	5 SC70-5	X5-1
LMX321AUK-T	-40°C to +125°C	5 SOT23-5	U5-1
LMX358AKA-T	-40°C to +125°C	8 SOT23-8	K8-2
LMX358ASA	-40°C to +125°C	8 SO	S8-2
LMX358AUA-T	-40°C to +125°C	8 µMAX-8	U8-1
LMX324ASD	-40°C to +125°C	14 SO	S14-4
LMX324AUD	-40°C to +125°C	14 TSSOP	U14-1

Selector Guide appears at end of data sheet.

Pin Configurations

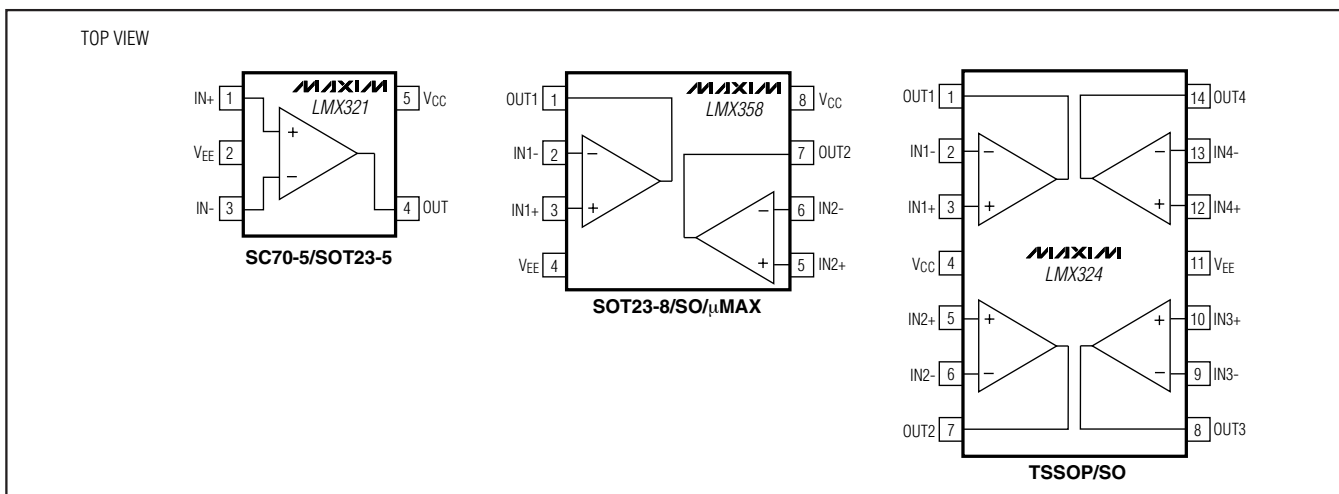

Single/Dual/Quad, General-Purpose, Low-Voltage, Rail-to-Rail Output Op Amps

ABSOLUTE MAXIMUM RATINGS

Supply Voltage (V _{CC} to V _{EE})	-0.3V to +8V	8-Pin SO (derate 5.9mW/°C above +70°C)	471mW
Differential Input Voltage (V _{IN+} - V _{IN-})	V _{EE} to V _{CC}	8-Pin μMAX (derate 4.5mW/°C above +70°C)	362mW
OUT ₋ to V _{EE}	-0.3V to (V _{CC} + 0.3V)	14-Pin TSSOP (derate 9.1mW/°C above +70°C)	727mW
Output Short-Circuit Duration		14-Pin SO (derate 8.3mW/°C above +70°C)	667mW
OUT ₋ Shorted to V _{CC} or V _{EE}	Continuous	Operating Temperature Range	-40°C to +125°C
Continuous Power Dissipation (T _A = +70°C)		Junction Temperature	+150°C
5-Pin SC70-5 (derate 3.1mW/°C above +70°C)	247mW	Storage Temperature Range	-65°C to +150°C
5-Pin SOT23-5 (derate 7.1mW/°C above +70°C)	571mW	Lead Temperature (soldering, 10s)	+300°C
8-Pin SOT23-8 (derate 7.52mW/°C above +70°C)	602mW		

Stresses beyond those listed under "Absolute Maximum Ratings" may cause permanent damage to the device. These are stress ratings only, and functional operation of the device at these or any other conditions beyond those indicated in the operational sections of the specifications is not implied. Exposure to absolute maximum rating conditions for extended periods may affect device reliability.

ELECTRICAL CHARACTERISTICS

(V_{CC} = +2.7V, V_{EE} = 0V, V_{OUT} = V_{CC}/2, V_{CM} = 1V, R_L > 1MΩ, T_A = +25°C, unless otherwise noted.)

PARAMETER	SYMBOL	CONDITIONS	MIN	TYP	MAX	UNITS
DC CHARACTERISTICS						
Input Offset Voltage	V _{OS}			1	6	mV
Input Offset Voltage Average Drift	TCV _{OS}			6		μV/°C
Input Bias Current	I _B			18	50	nA
Input Offset Current	I _{OS}			1	8	nA
Common-Mode Rejection Ratio	CMRR	-0.2V < V _{CM} < 1.8V	72	92		dB
Power-Supply Rejection Ratio	PSRR	2.3V ≤ V _{CC} ≤ 7V, V _{OUT} = 1V	82	96		dB
Input Common-Mode Voltage Range	V _{CM}	For CMRR ≥ 72dB	Limit	-0.2	+1.8	V
			Typ	-0.2	+1.9	
Large-Signal Voltage Gain	A _{VOL}	R _L = 2kΩ to V _{EE} , 0.3V < V _{OUT} < 2.4V	20	120		V/mV
Output-Voltage Swing	V _{OUT}	R _L = 10kΩ to 1.35V	V _{CC} - V _{OH}	12	50	mV
			V _{OL}	10	40	
		R _L = 2kΩ to 1.35V	V _{CC} - V _{OH}	40	110	
			V _{OL}	25	60	
Supply Current	I _{CC}	LMX321 (single)		105	150	μA
		LMX358 (dual)		210	300	
		LMX324 (quad)		420	600	
AC CHARACTERISTICS						
Slew Rate	SR	1V step Input		1		V/μs
Gain-Bandwidth Product	GBW	C _L = 200pF		1.3		MHz
Phase Margin	φ _M			64		degrees
Gain Margin	GM			24		dB
Input Noise-Voltage Density	e _n	f = 1kHz		66		nV/√Hz
Input Current-Noise Density	i _n	f = 1kHz		0.13		pA/√Hz

Single/Dual/Quad, General-Purpose, Low-Voltage, Rail-to-Rail Output Op Amps

LMX321/LMX358/LMX324

ELECTRICAL CHARACTERISTICS

($V_{CC} = +2.7V$, $V_{EE} = 0V$, $V_{OUT} = V_{CC}/2$, $V_{CM} = 1V$, $R_L > 1M\Omega$, $T_A = -40^{\circ}C$ to $+125^{\circ}C$, unless otherwise noted.) (Note 1)

PARAMETER	SYMBOL	CONDITIONS	MIN	TYP	MAX	UNITS
DC CHARACTERISTICS						
Input Offset Voltage	V_{OS}				9	mV
Input Bias Current	I_B				70	nA
Input Offset Current	I_{OS}				15	nA
Common-Mode Rejection Ratio	CMRR	$-0.1 < V_{CM} < +1.7V$	60			dB
Power-Supply Rejection Ratio	PSRR	$2.3V \leq V_{CC} \leq 7V$, $V_{OUT} = 1V$	75			dB
Input Common-Mode Voltage Range	V_{CM}	For CMRR ≥ 60 dB	Limit	-0.1	+1.7	V
			Typ	-0.1	+1.8	
Large-Signal Voltage Gain	A_{VOL}	$R_L = 2k\Omega$ to V_{EE} , $0.3V \leq V_{OUT} \leq 2.4V$	10			V/mV
Output-Voltage Swing	V_{OUT}	$R_L = 10k\Omega$ to 1.55V	$V_{CC} - V_{OH}$		130	mV
			V_{OL}		50	
		$R_L = 2k\Omega$ to 1.35V	$V_{CC} - V_{OH}$		150	
			V_{OL}		70	
Supply Current	I_{CC}	LMX321 (single)			180	μA
		LMX358 (dual)			360	
		LMX324 (quad)			720	

ELECTRICAL CHARACTERISTICS

($V_{CC} = +5V$, $V_{EE} = 0V$, $V_{OUT} = V_{CC}/2$, $V_{CM} = 2V$, $R_L > 1M\Omega$, $T_A = +25^{\circ}C$, unless otherwise noted.)

PARAMETER	SYMBOL	CONDITIONS	MIN	TYP	MAX	UNITS
DC CHARACTERISTICS						
Input Offset Voltage	V_{OS}			1	6	mV
Input Offset Voltage Average Drift	TCV_{OS}			6		$\mu V/^{\circ}C$
Input Bias Current	I_B			18	50	nA
Input Offset Current	I_{OS}			1	8	nA
Input Differential Clamp Voltage	V_{CLAMP}	Force 100 μA into $IN+$, $IN-$ = GND measure $V_{IN+} - V_{IN-}$, Figure 1		3.1		V
Common-Mode Rejection Ratio	CMRR	$-0.2 < V_{CM} < +4.1V$	72	92		dB
Power-Supply Rejection Ratio	PSRR	$2.3V \leq V_{CC} \leq 7V$, $V_{OUT} = 1V$, $V_{CM} = 1V$	82	96		dB
Input Common-Mode Voltage Range	V_{CM}	For CMRR ≥ 72 dB	Limit	-0.2	+4.1	V
			Typ	-0.2	+4.2	
Large-Signal Voltage Gain	A_{VOL}	$R_L = 2k\Omega$ to V_{EE} , $0.3V \leq V_{OUT} \leq 4.7V$	40	200		V/mV

Single/Dual/Quad, General-Purpose, Low-Voltage, Rail-to-Rail Output Op Amps

ELECTRICAL CHARACTERISTICS (continued)

($V_{CC} = +5V$, $V_{EE} = 0V$, $V_{OUT} = V_{CC}/2$, $V_{CM} = 2V$, $R_L > 1M\Omega$, $T_A = +25^\circ C$, unless otherwise noted.)

PARAMETER	SYMBOL	CONDITIONS	MIN	TYP	MAX	UNITS
Output-Voltage Swing	V_{OUT}	$R_L = 10k\Omega$ to 2.5V	$V_{CC} - V_{OH}$	20	60	mV
			V_{OL}	12	40	
		$R_L = 2k\Omega$ to 2.5V	$V_{CC} - V_{OH}$	65	130	
			V_{OL}	40	80	
Output Short-Circuit Current	I_{SC}	Sourcing, $V_{OUT} = 0V$	5	25	mA	
		Sinking, $V_{OUT} = 5V$	10	28		
Supply Current	I_{CC}	LMX321 (single)		120	170	μA
		LMX358 (dual)		240	340	
		LMX324 (quad)		480	680	
AC CHARACTERISTICS						
Slew Rate	SR	3V step input		1		V/ μs
Gain-Bandwidth Product	GBW	$C_L = 200pF$		1.3		MHz
Phase Margin	ϕ_M			65		degrees
Gain Margin	GM			25		dB
Input Noise-Voltage Density	e_n	$f = 1kHz$		65		nV/\sqrt{Hz}
Input Noise-Current Density	i_n	$f = 1kHz$		0.13		pA/\sqrt{Hz}

ELECTRICAL CHARACTERISTICS

($V_{CC} = +5V$, $V_{EE} = 0V$, $V_{OUT} = V_{CC}/2$, $V_{CM} = 2V$, $R_L > 1M\Omega$, $T_A = -40^\circ C$ to $+125^\circ C$, unless otherwise noted.) (Note 1)

PARAMETER	SYMBOL	CONDITIONS	MIN	TYP	MAX	UNITS
DC CHARACTERISTICS						
Input Offset Voltage	V_{OS}				9	mV
Input Bias Current	I_B				70	nA
Input Offset Current	I_{OS}				15	nA
Common-Mode Rejection Ratio	CMRR	$-0.1 < V_{CM} < +4.0V$	63			dB
Power-Supply Rejection Ratio	PSRR	$2.3V \leq V_{CC} \leq 7V$, $V_{OUT} = 1V$, $V_{CM} = 1V$	75			dB
Input Common-Mode Voltage Range	V_{CM}	For CMRR $\geq 63dB$	Limit	-0.1	+4.0	V
			Typ	-0.1	+4.1	
Large-Signal Voltage Gain	A_{VOL}	$R_L = 2k\Omega$ to V_{EE} , $0.3V \leq V_{OUT} \leq 4.7V$	20			V/mV
Output-Voltage Swing	V_{OUT}	$R_L = 10k\Omega$ to 2.5V	$V_{CC} - V_{OH}$		170	mV
			V_{OL}		70	
		$R_L = 2k\Omega$ to 2.5V	$V_{CC} - V_{OH}$		190	
			V_{OL}		90	
Supply Current	I_{CC}	LMX321 (single)			210	μA
		LMX358 (dual)			420	
		LMX324 (quad)			840	

Note 1: Specifications are 100% tested at $T_A = +25^\circ C$ (exceptions noted). All temperature limits are guaranteed by design.

Single/Dual/Quad, General-Purpose, Low-Voltage, Rail-to-Rail Output Op Amps

Typical Operating Characteristics

($T_A = +25^\circ\text{C}$, $V_{EE} = 0\text{V}$, unless otherwise noted.)

LMX321/LMX358/LMX324

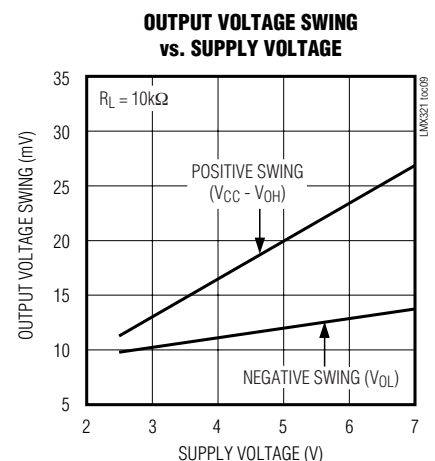
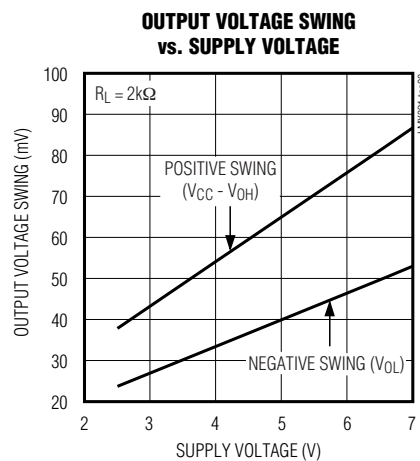
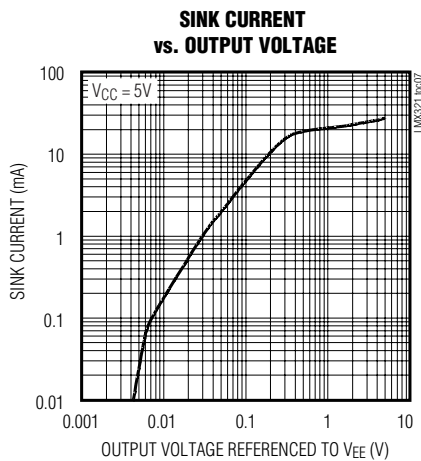
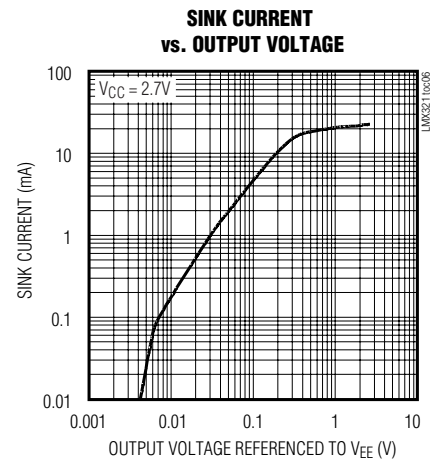
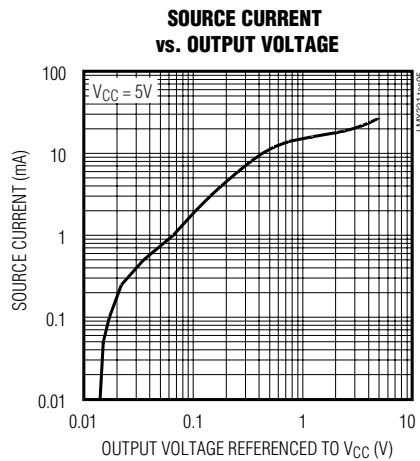
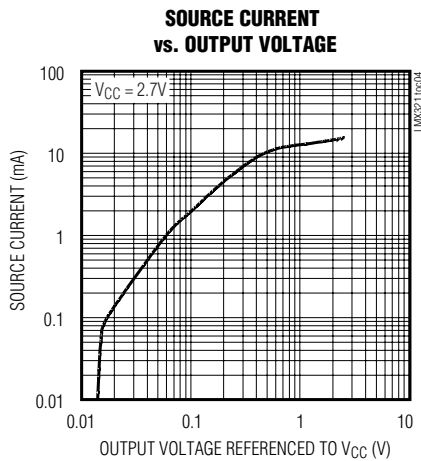
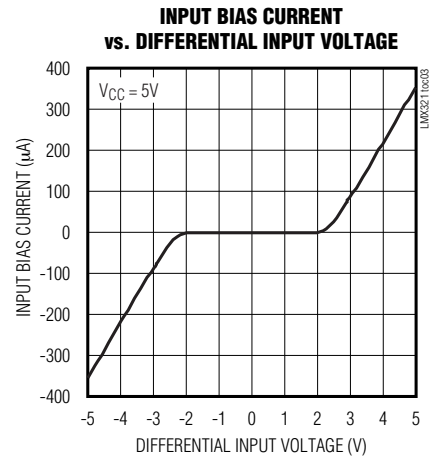
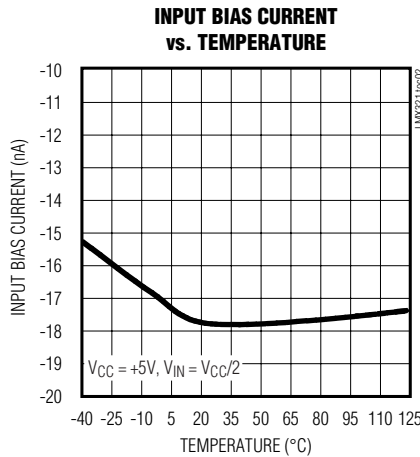
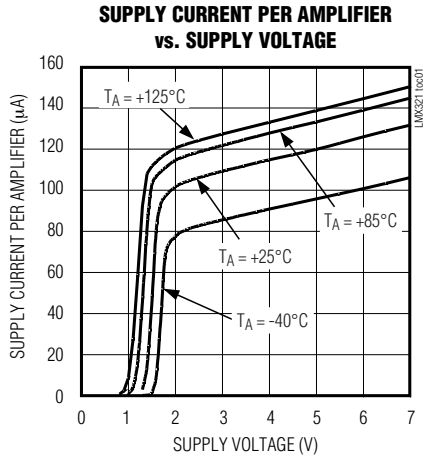

Single/Dual/Quad, General-Purpose, Low-Voltage, Rail-to-Rail Output Op Amps

Typical Operating Characteristics (continued)

($T_A = +25^\circ\text{C}$, $V_{EE} = 0\text{V}$, unless otherwise noted.)

INPUT VOLTAGE NOISE vs. FREQUENCY

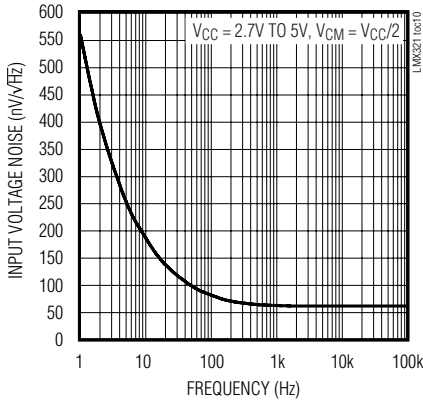

INPUT CURRENT NOISE vs. FREQUENCY

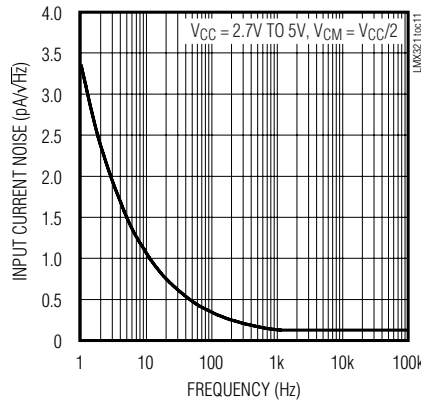

CROSSTALK REJECTION vs. FREQUENCY

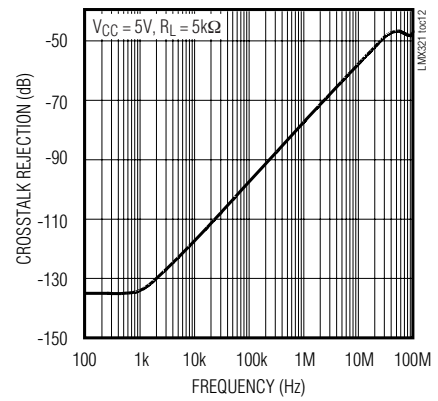

POWER-SUPPLY REJECTION RATIO vs. FREQUENCY

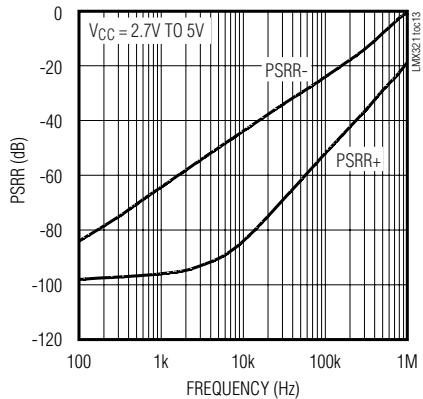

INPUT OFFSET VOLTAGE vs. COMMON-MODE VOLTAGE

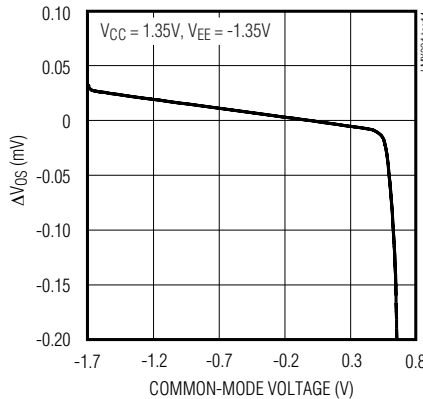

INPUT OFFSET VOLTAGE vs. COMMON-MODE VOLTAGE

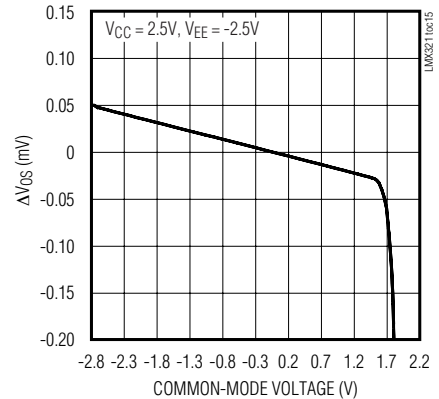

INPUT OFFSET VOLTAGE vs. OUTPUT VOLTAGE

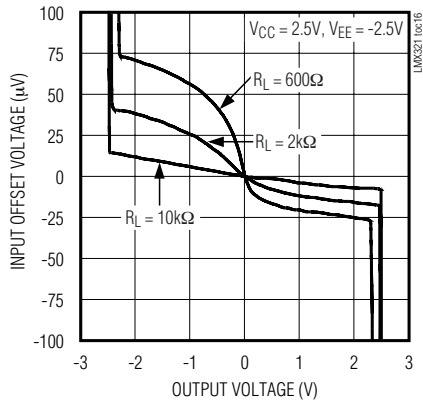

INPUT OFFSET VOLTAGE vs. OUTPUT VOLTAGE

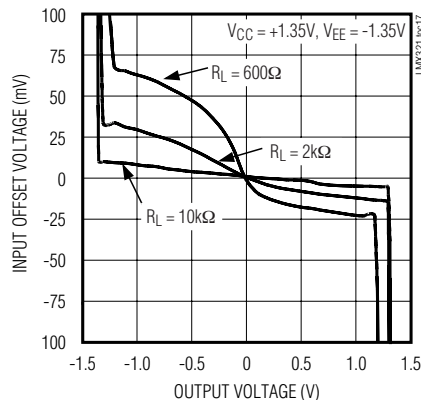

GAIN AND PHASE vs. FREQUENCY and RESISTIVE LOAD

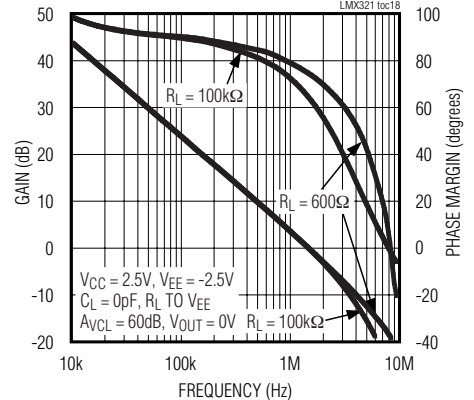

Single/Dual/Quad, General-Purpose, Low-Voltage, Rail-to-Rail Output Op Amps

Typical Operating Characteristics (continued)

($T_A = +25^\circ\text{C}$, $V_{EE} = 0\text{V}$, unless otherwise noted.)

LMX321/LMX358/LMX324

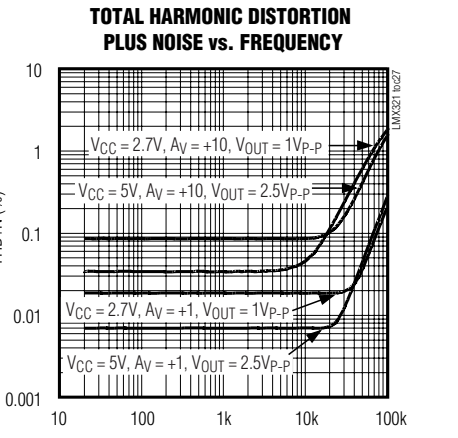
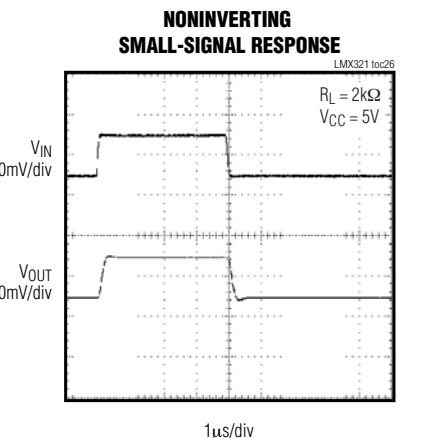
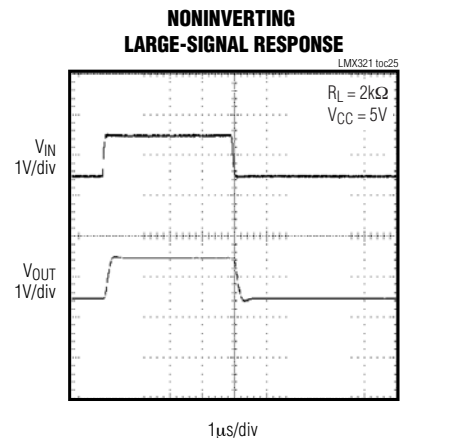
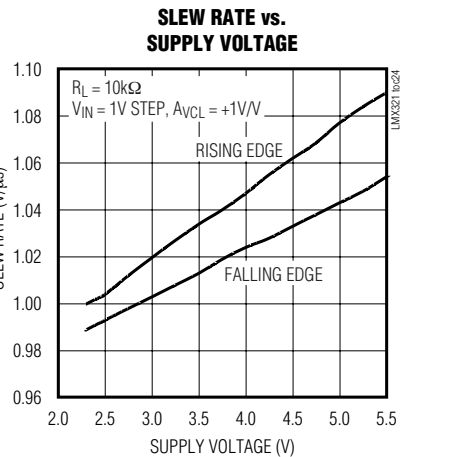
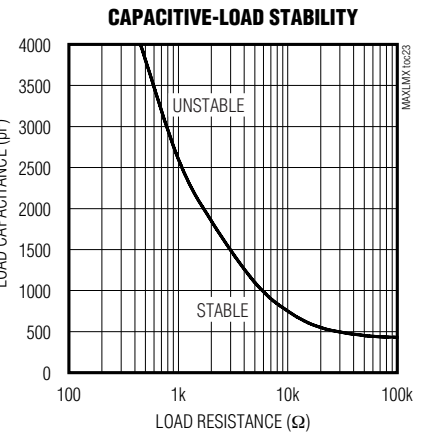
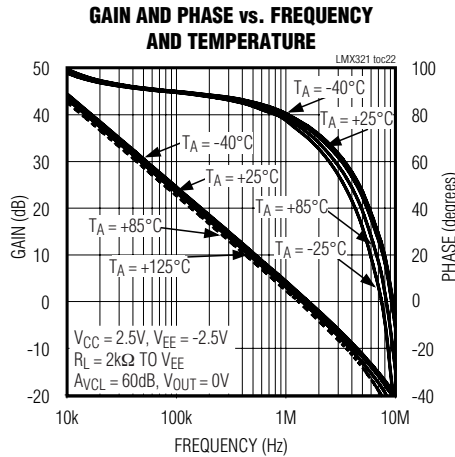
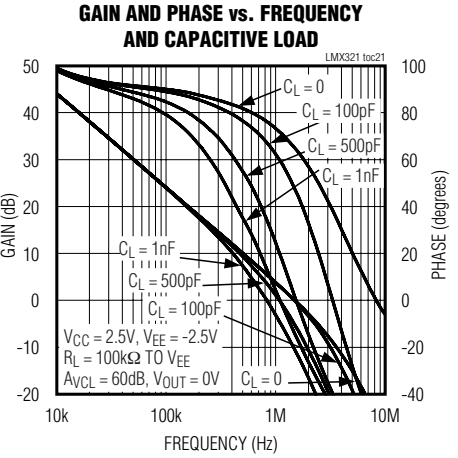
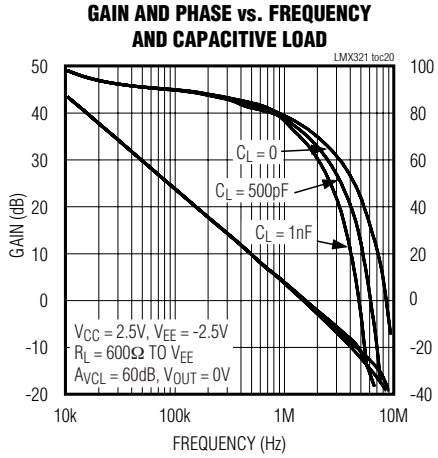
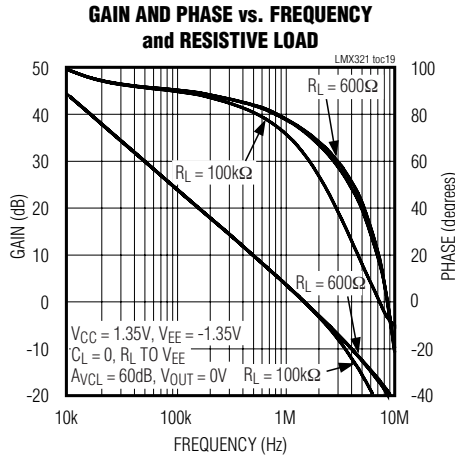

Single/Dual/Quad, General-Purpose, Low-Voltage, Rail-to-Rail Output Op Amps

Typical Operating Characteristics (continued)

($T_A = +25^\circ\text{C}$, $V_{EE} = 0\text{V}$, unless otherwise noted.)

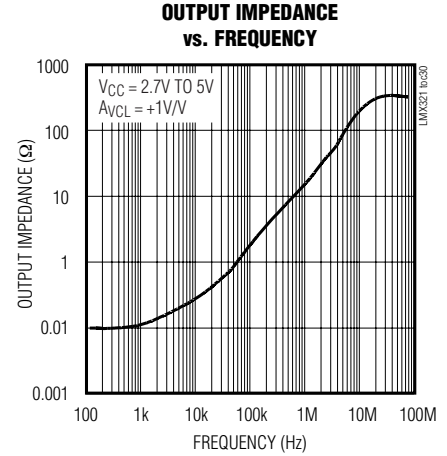
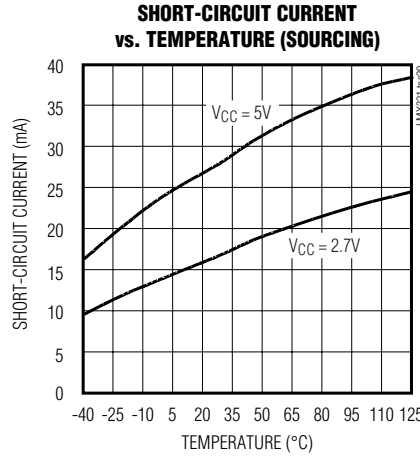
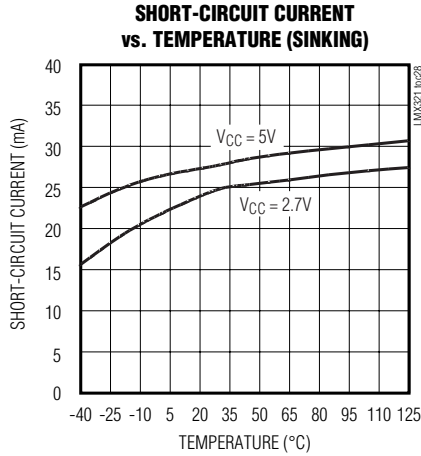

Pin Description

PIN			NAME	FUNCTION
LMX321	LMX358	LMX324		
1	—	—	IN+	Noninverting Amplifier Input
2	4	11	V _{EE}	Negative Supply. Connect to ground for single-supply operation.
3	—	—	IN-	Inverting Amplifier Input
4	—	—	OUT	Output
5	8	4	V _{CC}	Positive Supply
—	1	1	OUT1	Output for Amplifier 1
—	2	2	IN1-	Inverting Input for Amplifier 1
—	3	3	IN1+	Noninverting Input for Amplifier 1
—	7	7	OUT2	Output for Amplifier 2
—	6	6	IN2-	Inverting Input for Amplifier 2
—	5	5	IN2+	Noninverting Input for Amplifier 2
—	—	8	OUT3	Output for Amplifier 3
—	—	9	IN3-	Inverting Input for Amplifier 3
—	—	10	IN3+	Noninverting Input for Amplifier 3
—	—	14	OUT4	Output for Amplifier 4
—	—	13	IN4-	Inverting Input for Amplifier 4
—	—	12	IN4+	Noninverting Input for Amplifier 4

Single/Dual/Quad, General-Purpose, Low-Voltage, Rail-to-Rail Output Op Amps

LMX321/LMX358/LMX324

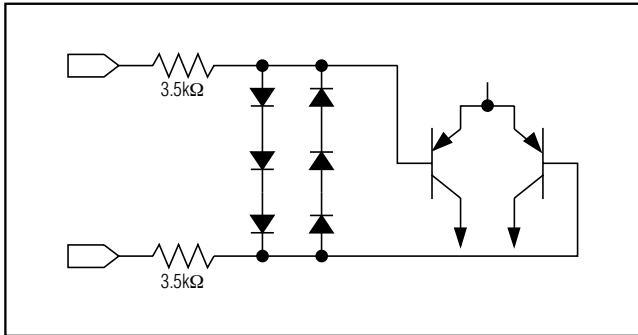

Figure 1. Input Protection Circuit

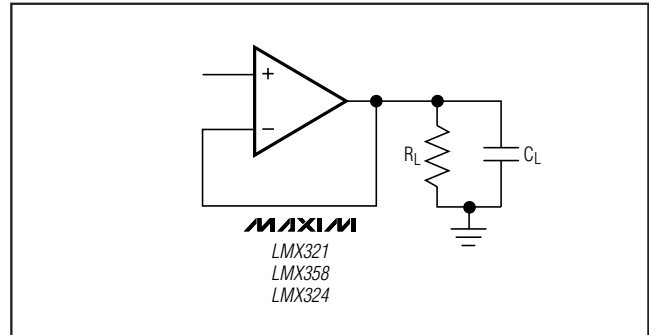

Figure 3. Capacitive-Load-Driving Circuit

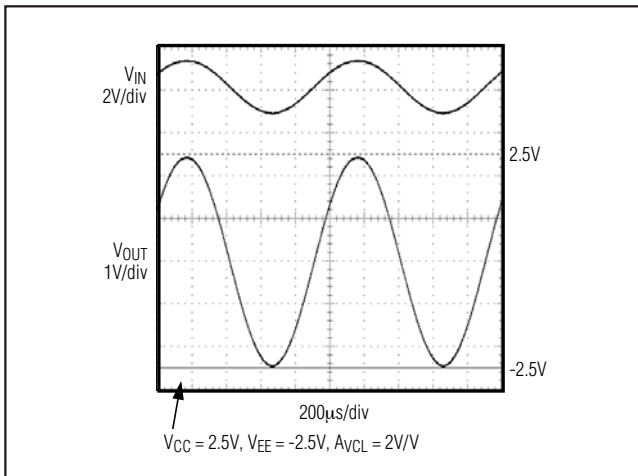

Figure 2. Rail-to-Rail Output Swing

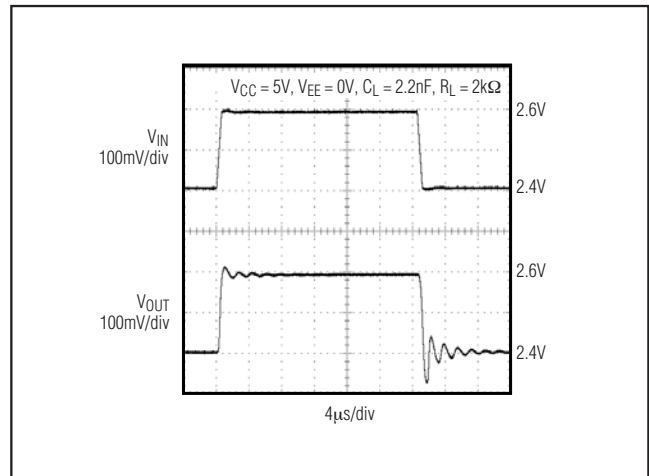

Figure 4. Output With Excessive Capacitive Load

Detailed Description

Input Protection Circuit

The LMX321/LMX358/LMX324's inputs are protected from large differential input voltages by internal 3.5kΩ series resistors and back-to-back triple diode stacks across the inputs (Figure 1). For differential input voltages (much less than 1.8V), input resistance is typically 3MΩ. For differential input voltages greater than 1.8V, input resistance is around 7kΩ, and the input bias current can be approximated by the following equation:

$$I_{BIAS} = (V_{DIFF} - 1.8V) / 7k\Omega$$

In the region where the differential input voltage approaches 1.8V, input resistance decreases exponentially from 3MΩ to 7kΩ as the diode block begins conducting. Inversely, the bias current increases with the same curve.

Rail-to-Rail Output Stage

The LMX321/LMX358/LMX324 drive 2kΩ loads and still typically swing within 40mV of the supply rails. Figure 2 shows the output voltage swing of the LMX321 configured with $A_{VCL} = +2V/V$.

Driving Capacitive Loads

Driving a capacitive load can cause instability in many op amps, especially those with low quiescent current. The LMX321/LMX358/LMX324 are unity-gain stable for a range of capacitive loads to above 400pF. Figure 4 shows the response of the LMX321 with an excessive capacitive load. Adding a series resistor between the output and the load capacitor (Figure 5) improves the circuit's response by isolating the load capacitance from the op amp's output.

Single/Dual/Quad, General-Purpose, Low-Voltage, Rail-to-Rail Output Op Amps

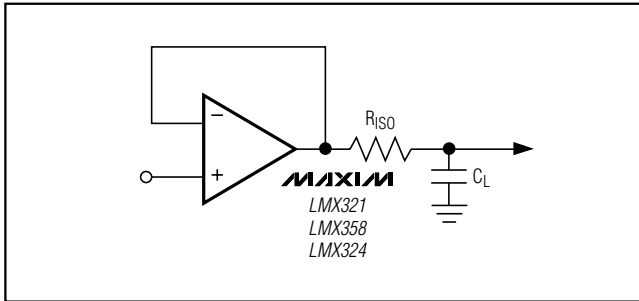

Figure 5. Capacitive-Load-Driving Circuit With Isolation Resistor

Applications Information

Power-Up

The LMX321/LMX358/LMX324 outputs typically settle within 10µs after power-up. Figure 6 shows the output voltage on power-up and power-down.

Power Supplies and Layout

The LMX321/LMX358/LMX324 operate from a single +2.3V to +7V power supply. Bypass the power supply with a 0.1µF capacitor to ground as close to VCC as possible.

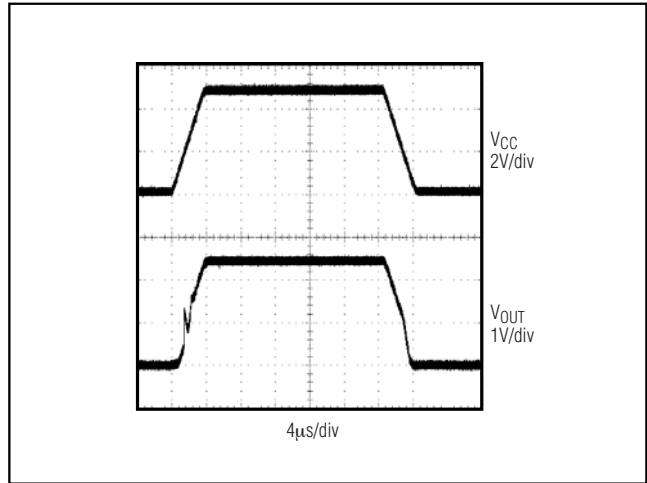

Figure 6. Power-Up/Power-Down Waveform

Good layout techniques optimize performance by minimizing the amount of stray capacitance at the op amp's inputs and outputs. Place external components close to the op amp to minimize trace lengths and stray capacitance.

Selector Guide

PART	AMPLIFIERS PER PACKAGE	TOP MARK
LMX321AXK-T	1	ACP
LMX321AUK-T	1	ADSQ
LMX358AKA-T	2	AAIR
LMX358ASA	2	—
LMX358AUA-T	2	—
LMX324ASD	4	—
LMX324AUD	4	—

Chip Information

LMX321 TRANSISTOR COUNT: 88
 LMX358 TRANSISTOR COUNT: 175
 LMX324 TRANSISTOR COUNT: 349
 PROCESS: Bipolar

Single/Dual/Quad, General-Purpose, Low-Voltage, Rail-to-Rail Output Op Amps

Package Information

(The package drawing(s) in this data sheet may not reflect the most current specifications. For the latest package outline information go to www.maxim-ic.com/packages.)

LMX321/LMX358/LMX324

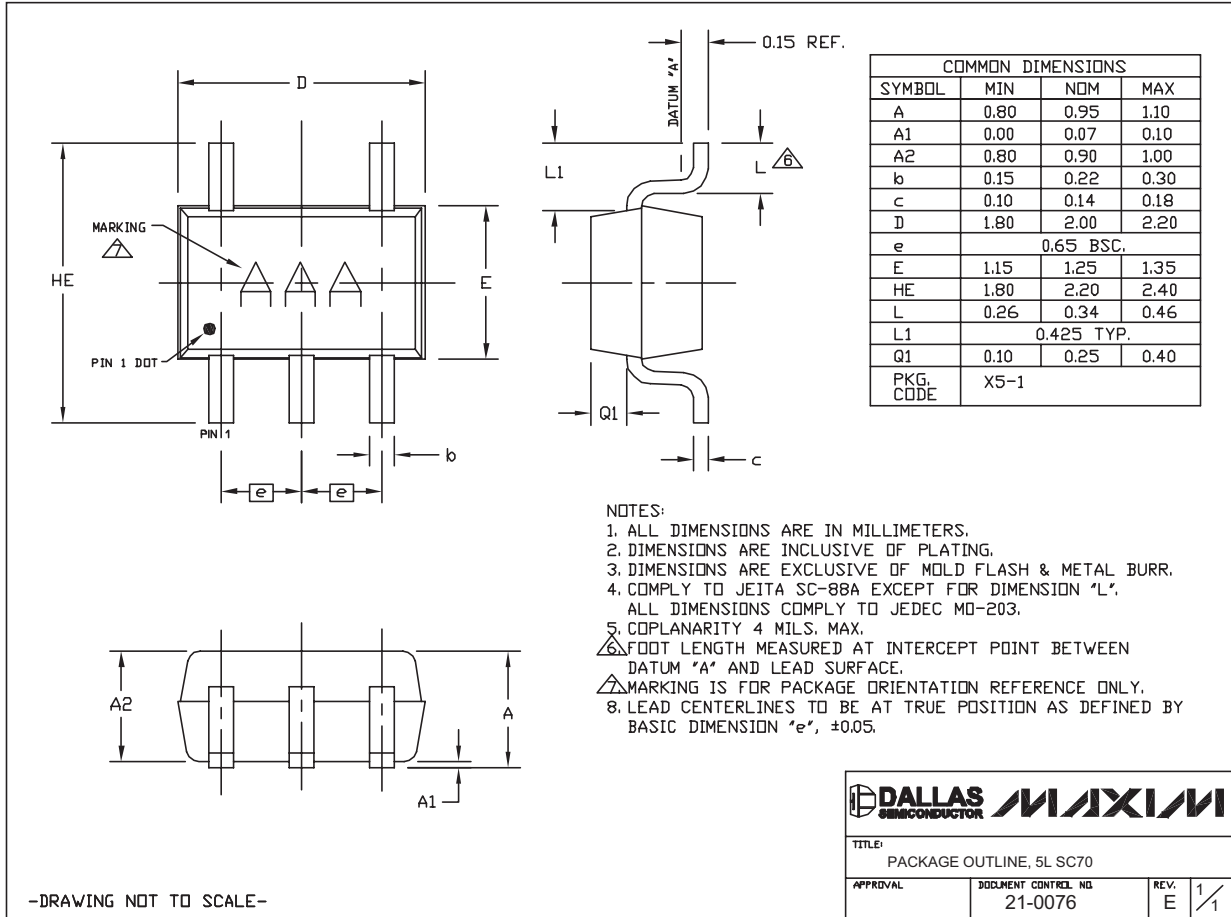

SC70, 5LEPS

Single/Dual/Quad, General-Purpose, Low-Voltage, Rail-to-Rail Output Op Amps

Package Information (continued)

(The package drawing(s) in this data sheet may not reflect the most current specifications. For the latest package outline information go to www.maxim-ic.com/packages.)

SYMBOL	MIN	NOM	MAX
A	0.90	1.25	1.45
A1	0.00	0.05	0.15
A2	0.90	1.10	1.30
b	0.35	0.40	0.50
C	0.08	0.15	0.20
D	2.80	2.90	3.00
E	2.60	2.80	3.00
E1	1.50	1.625	1.75
L	0.35	0.45	0.60
L1	0.60 REF		
e	0.95 BSC.		
e1	1.90 BSC.		
a	0°	2.5°	8°
PKG CODES: U5-1, U5-2			

NOTES:
 1. ALL DIMENSIONS ARE IN MILLIMETERS.
 2. FOOT LENGTH MEASURED AT INTERCEPT POINT BETWEEN DATUM A & LEAD SURFACE.
 3. PACKAGE OUTLINE EXCLUSIVE OF MOLD FLASH & METAL BURR. MOLD FLASH, PROTRUSION OR METAL BURR SHOULD NOT EXCEED 0.25 MM.
 4. PACKAGE OUTLINE INCLUSIVE OF SOLDER PLATING.
 5. MEETS JEDEC MO178, VARIATION AA.
 6. LEADS TO BE COPLANAR WITHIN 0.10 mm.
 7. SOLDER THICKNESS MEASURED AT FLAT SECTION OF LEAD BETWEEN 0.08mm AND 0.15mm FROM LEAD TIP.

PROPRIETARY INFORMATION TITLE: PACKAGE OUTLINE, SOT-23, 5L			
APPROVAL	DOCUMENT CONTROL NO. 21-0057	REV. F	1/1

SOT-23 5L, EPS

Single/Dual/Quad, General-Purpose, Low-Voltage, Rail-to-Rail Output Op Amps

Package Information (continued)

(The package drawing(s) in this data sheet may not reflect the most current specifications. For the latest package outline information go to www.maxim-ic.com/packages.)

LMX321/LMX358/LMX324

PIN 1 I.D. DOT (SEE NOTE 6)

SYMBOL	MIN	NOM	MAX
A	0.90	1.25	1.45
A1	0.00	0.06	0.15
A2	0.90	1.10	1.30
b	0.22	0.30	0.38
C	0.08	0.15	0.22
D	2.80	2.90	3.00
E	2.60	2.80	3.00
E1	1.50	1.625	1.75
L	0.30	0.45	0.60
L2	0.25 BSC.		
e	0.65 BSC.		
e1	1.95 REF.		
θ	0°	3°	8°

PKG CODES: K8-1, K8-2, K8S-3, K8F-4, K8FH-4, K8-5, K8C-6

DETAIL "A"

NOTE:

- ALL DIMENSIONS ARE IN MILLIMETERS.
- △ FOOT LENGTH MEASURED FROM LEAD TIP TO UPPER RADIUS OF HEEL OF THE LEAD PARALLEL TO SEATING PLANE C.
- PACKAGE OUTLINE EXCLUSIVE OF MOLD FLASH & METAL BURR.
- PACKAGE OUTLINE INCLUSIVE OF SOLDER PLATING.
- COPLANARITY 4 MILS. MAX.
- PIN 1 I.D. DOT IS 0.3 MM Ø MIN. LOCATED ABOVE PIN 1.
- SOLDER THICKNESS MEASURED AT FLAT SECTION OF LEAD BETWEEN 0.08mm AND 0.15mm FROM LEAD TIP.
- MEETS JEDEC MO178 VARIATION BA.

—DRAWING NOT TO SCALE—

TITLE: PACKAGE OUTLINE, SOT-23, 8L BODY		
APPROVAL	DOCUMENT CONTROL NO. 21-0078	REV. F 1/1

SOT23, 8L-LEPS

Single/Dual/Quad, General-Purpose, Low-Voltage, Rail-to-Rail Output Op Amps

Package Information (continued)

(The package drawing(s) in this data sheet may not reflect the most current specifications. For the latest package outline information go to www.maxim-ic.com/packages.)

8LUMAXDEFS

TOP VIEW

BOTTOM VIEW

FRONT VIEW

SIDE VIEW

DIM	INCHES		MILLIMETERS	
	MIN	MAX	MIN	MAX
A	-	0.043	-	1.10
A1	0.002	0.006	0.05	0.15
A2	0.030	0.037	0.75	0.95
b	0.010	0.014	0.25	0.36
c	0.005	0.007	0.13	0.18
D	0.116	0.120	2.95	3.05
e	0.0256 BSC		0.65 BSC	
E	0.116	0.120	2.95	3.05
H	0.188	0.198	4.78	5.03
L	0.016	0.026	0.41	0.66
α	0°	6°	0°	6°
S	0.0207 BSC		0.5250 BSC	

NOTES:

1. D&E DO NOT INCLUDE MOLD FLASH.
2. MOLD FLASH OR PROTRUSIONS NOT TO EXCEED 0.15MM (.006").
3. CONTROLLING DIMENSION: MILLIMETERS.
4. MEETS JEDEC MO-187C-AA.

DALLAS SEMICONDUCTOR **MAXIM**

PROPRIETARY INFORMATION

TITLE: PACKAGE OUTLINE, 8L uMAX/uSOP

APPROVAL	DOCUMENT CONTROL NO. 21-0036	REV. J 1/1
----------	---------------------------------	------------

Single/Dual/Quad, General-Purpose, Low-Voltage, Rail-to-Rail Output Op Amps

Package Information (continued)

(The package drawing(s) in this data sheet may not reflect the most current specifications. For the latest package outline information go to www.maxim-ic.com/packages.)

LMX321/LMX358/LMX324

DIMENSIONS	COMMON DIMENSIONS			
	MILLIMETERS		INCHES	
	MIN.	MAX.	MIN.	MAX.
A	—	1.10	.043	
A ₁	0.05	0.15	.002	.006
A ₂	0.85	0.95	.033	.037
b	0.19	0.30	.007	.012
b ₁	0.19	0.25	.007	.010
c	0.09	0.20	.004	.008
c ₁	0.09	0.14	.004	.006
D	SEE VARIATIONS	SEE VARIATIONS		
E	4.30	4.50	.169	.177
e	0.65 BSC		.026 BSC	
H	6.25	6.55	.246	.258
L	0.50	0.70	.020	.028
N	SEE VARIATIONS	SEE VARIATIONS		
α	0°	8°	0°	8°
klbl	0.10 MAX			

JEDEC MO-153	N	PKG. CODES	VARIATIONS			
			MILLIMETERS		INCHES	
			MIN.	MAX.	MIN.	MAX.
AB-1	14	U14-1j U14-2	4.90	5.10	.193	.201
AB	16	U16-1j U16-2	4.90	5.10	.193	.201
AC	20	U20-2j U20-3	6.40	6.60	.252	.260
AD	24	U24-1	7.70	7.90	.303	.311
AE	28	U28-1j U28-2j U28-3	9.60	9.80	.378	.386

NOTES

- DIMENSIONS D AND E DO NOT INCLUDE FLASH
- MOLD FLASH OR PROTRUSIONS NOT TO EXCEED 0.15mm PER SIDE
- CONTROLLING DIMENSION: MILLIMETER
- MEETS JEDEC OUTLINE MO-153. SEE JEDEC VARIATIONS TABLE
- "N" REFERS TO NUMBER OF LEADS
- LEAD COPLANARITY 0.10 MM MAX.
- NUMBER OF LEADS SHOWN ARE FOR REFERENCE ONLY
- MARKING IS FOR PACKAGE ORIENTATION REFERENCE ONLY
- BENT LEAD 0.10 MM MAX.

-DRAWING NOT TO SCALE-

TSSOP4, 4.0mm, EPS

DALLAS SEMICONDUCTOR **MAXIM**

TITLE: PACKAGE OUTLINE, TSSOP 4.0mm BODY

APPROVAL	DOCUMENT CONTROL NO. 21-0066	REV. I 1/1
----------	---------------------------------	------------

Maxim cannot assume responsibility for use of any circuitry other than circuitry entirely embodied in a Maxim product. No circuit patent licenses are implied. Maxim reserves the right to change the circuitry and specifications without notice at any time.

Maxim Integrated Products, 120 San Gabriel Drive, Sunnyvale, CA 94086 408-737-7600 15

Looking for pricing, stock, or lifecycle information?

Click below to explore more details on WIN SOURCE:

 [View LMX358AKA-T on WIN SOURCE](#)

 [Maxim Integrated Information](#)

Optimize Your Supply Chain with WIN SOURCE Solutions

-  Global Sourcing Solution
-  Obsolete Management
-  Cost Control Management
-  Shortage Management
-  Alternative Solution
-  Excess Inventory Management