



**THE DATASHEET OF  
SN65LBC179ADR**



## LOW-POWER DIFFERENTIAL LINE DRIVER AND RECEIVER PAIRS

Check for Samples: [SN65LBC179A](#), [SN75LBC179A](#)

### FEATURES

- **High-Speed Low-Power LinBiCMOS™ Circuitry Designed for Signaling Rates<sup>(1)</sup> of up to 30 Mbps**
- **Bus-Pin ESD Protection Exceeds 12 kV HBM**
- **Very Low Disabled Supply-Current Requirements . . . 700  $\mu$ A Max**
- **Common-Mode Voltage Range of –7 V to 12 V**
- **Low Supply Current . . .15 mA Max**
- **Compatible With ANSI Standard TIA/EIA-485-A and ISO8482: 1987(E)**
- **Positive and Negative Output Current Limiting**
- **Driver Thermal Shutdown Protection**

<sup>(1)</sup>Signaling rate by TIA/EIA-485-A definition restrict transition times to 30% of the bit length, and much higher signaling rates may be achieved without this requirement as displayed in the *TYPICAL CHARACTERISTICS* of this device.

SN65LBC179AD (Marked as BL179A)  
SN65LBC179AP (Marked as 65LBC179A)  
SN75LBC179AD (Marked as LB179A)  
SN75LBC179AP (Marked as 75LBC179A)

(TOP VIEW)

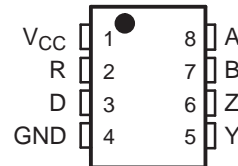

### LOGIC DIAGRAM (POSITIVE LOGIC)

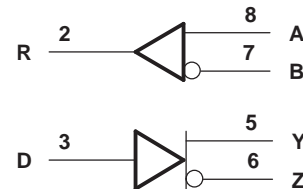

### DESCRIPTION

The SN65LBC179A and SN75LBC179A differential driver and receiver pairs are monolithic integrated circuits designed for bidirectional data communication over long cables that take on the characteristics of transmission lines. They are balanced, or differential, voltage mode devices that are compatible with ANSI standard TIA/EIA-485-A and ISO 8482:1987(E). The A version offers improved switching performance over its predecessors without sacrificing significantly more power.

The SN65LBC179A and SN75LBC179A combine a differential line driver and differential input line receiver and operate from a single 5-V supply. The driver differential outputs and the receiver differential inputs are connected to separate terminals for full-duplex operation and are designed to present minimum loading to the bus when powered off ( $V_{CC} = 0$ ). These parts feature a wide positive and negative common-mode voltage range making them suitable for point-to-point or multipoint data bus applications. The devices also provide positive- and negative-current limiting and thermal shutdown for protection from line fault conditions.

The SN65LBC179A is characterized over the industrial temperature range of –40°C to 85°C. The SN75LBC179A is characterized for operation over the commercial temperature range of 0°C to 70°C.

**FUNCTION TABLE<sup>(1)</sup>**

DRIVER			RECEIVER	
INPUT D	OUTPUTS		DIFFERENTIAL INPUTS A – B	OUTPUT R
	Y	Z		
H	H	L	$V_{ID} \geq 0.2$ V	H
L	L	H	$-0.2$ V < $V_{ID} < 0.2$ V	?
OPEN	H	L	$V_{ID} \leq -0.2$ V	L
	H	L	Open circuit	H

(1) H = high level, L = low level, ? = indeterminate



Please be aware that an important notice concerning availability, standard warranty, and use in critical applications of Texas Instruments semiconductor products and disclaimers thereto appears at the end of this data sheet.

LinBiCMOS is a trademark of Texas Instruments.

PRODUCTION DATA information is current as of publication date. Products conform to specifications per the terms of the Texas Instruments standard warranty. Production processing does not necessarily include testing of all parameters.

Copyright © 2000–2011, Texas Instruments Incorporated



These devices have limited built-in ESD protection. The leads should be shorted together or the device placed in conductive foam during storage or handling to prevent electrostatic damage to the MOS gates.

AVAILABLE OPTIONS

T <sub>A</sub>	PACKAGE	
	SMALL OUTLINE (D)	PLASTIC DUAL-IN-LINE
0°C to 70°C	SN75LBC179AD	SN75LBC179AP
-40°C to 85°C	SN65LBC179AD	SN65LBC179AP

SCHEMATICS OF INPUTS AND OUTPUTS

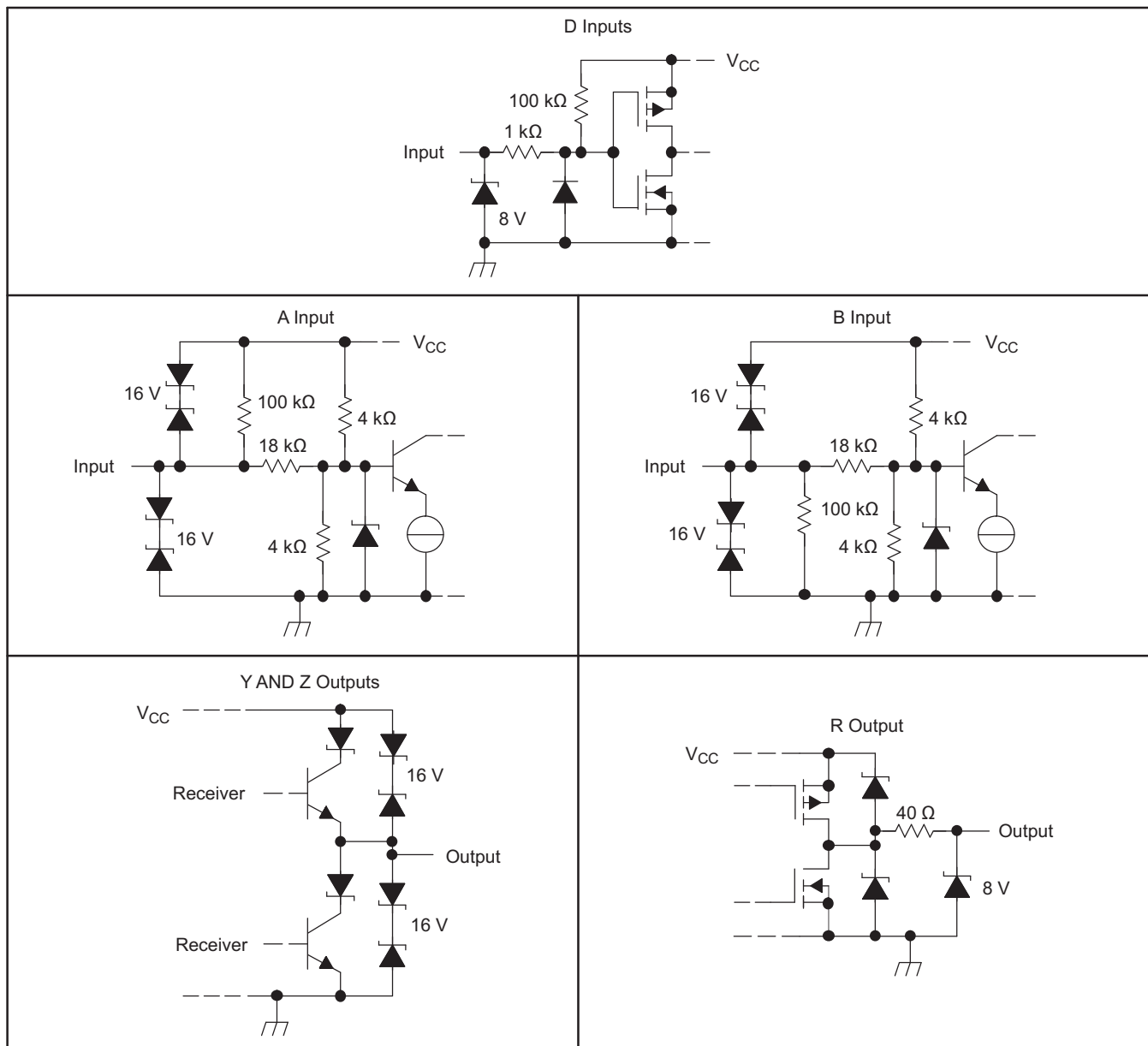

## ABSOLUTE MAXIMUM RATINGS<sup>(1)</sup>

over operating free-air temperature range (unless otherwise noted)

		UNIT
$V_{CC}$	Supply voltage range <sup>(2)</sup>	–0.3 V to 6 V
	Voltage range	A, B, Y, or Z <sup>(2)</sup>
		D or R <sup>(2)</sup>
$I_O$	Receiver output current	±20 mA
	Electrostatic discharge	Bus terminals and GND, Class 3, A <sup>(3)</sup>
		Bus terminals and GND, Class 3, B <sup>(3)</sup>
		All terminals, Class 3, A
		All terminals, Class 3, B
Continuous total power dissipation <sup>(4)</sup>		Internally limited
Total power dissipation		See Dissipation Rating Table

- (1) Stresses beyond those listed under *absolute maximum ratings* may cause permanent damage to the device. These are stress ratings only, and functional operation of the device at these or any other conditions beyond those indicated under *recommended operating conditions* is not implied. Exposure to absolute-maximum-rated conditions for extended periods may affect device reliability.
- (2) All voltage values, except differential I/O bus voltages, are with respect to GND.
- (3) Tested in accordance with MIL-STD-883C, Method 3015.7
- (4) The maximum operating junction temperature is internally limited. Uses the dissipation rating table to operate below this temperature.

## DISSIPATION RATINGS

PACKAGE	$T_A \leq 25^\circ\text{C}$ POWER RATING	DERATING FACTOR <sup>(1)</sup> ABOVE $T_A = 25^\circ\text{C}$	$T_A = 70^\circ\text{C}$ POWER RATING	$T_A = 85^\circ\text{C}$ POWER RATING
D	725 mW	5.8 mW/°C	464 mW	377 mW
P	1100 mW	8.08 mW/°C	640 mW	520 mW

- (1) This is the inverse of the junction-to-ambient thermal resistance when board-mounted and with no air flow.

## RECOMMENDED OPERATING CONDITIONS

		MIN	NOM	MAX	UNIT
$V_{CC}$	Supply voltage	4.75	5	5.25	V
$V_{IH}$	High-level input voltage	D		$V_{CC}$	V
$V_{IL}$	Low-level input voltage	D		0.8	V
$V_{ID}$	Differential input voltage <sup>(1)</sup>	–12 <sup>(2)</sup>		12	V
$V_O$	Voltage at any bus terminal (separately or common-mode)	A, B, Y, or Z	–7	12	V
$V_I$					
$V_{IC}$					
$I_{OH}$	High-level output current	Y or Z	–60		mA
		R	–8		
$I_{OL}$	Low-level output current	Y or Z		60	mA
		R		8	
$T_A$	Operating free-air temperature	SN65LBC179A	–40	85	°C
		SN75LBC179A	0	70	

- (1) Differential input/output bus voltage is measured at the noninverting terminal with respect to the inverting terminal.
- (2) The algebraic convention, in which the least positive (most negative) limit is designated as minimum, is used in this data sheet.

## DRIVER ELECTRICAL CHARACTERISTICS

over recommended operating conditions (unless otherwise noted)

PARAMETER		TEST CONDITIONS		MIN	TYP <sup>(1)</sup>	MAX	UNIT
$V_{IK}$	Input clamp voltage	$I_I = -18 \text{ mA}$		-1.5	-0.8		V
$ V_{OD} $	Differential output voltage	$R_L = 54 \Omega$ , See <a href="#">Figure 1</a>	SN65LBC179A	1	1.5	3	V
			SN75LBC179A	1.1	1.5	3	V
		$R_L = 60 \Omega$ , $-7 < V_{(tot)} < 12$ , See <a href="#">Figure 2</a>	SN65LBC179A	1	1.5	3	V
			SN75LBC179A	1.1	1.5	3	V
$\Delta  V_{OD} $	Change in magnitude of differential output voltage <sup>(2)</sup>	See <a href="#">Figure 1</a> and <a href="#">Figure 2</a>		-0.2		0.2	V
$V_{OC(SS)}$	Steady-state common-mode output voltage	See <a href="#">Figure 1</a>		1.8	2.4	2.8	V
$\Delta V_{OC(SS)}$	Change in steady-state common-mode output voltage <sup>(2)</sup>			-0.1		0.1	V
$I_O$	Output current with power off	$V_{CC} = 0$ ,	$V_O = -7 \text{ V to } 12 \text{ V}$	-10	$\pm 1$	10	$\mu\text{A}$
$I_{IH}$	High-level input current	$V_I = 2 \text{ V}$		-100			$\mu\text{A}$
$I_{IL}$	Low-level input current	$V_I = 0.8 \text{ V}$		-100			$\mu\text{A}$
$I_{OS}$	Short-circuit output current	$-7 \text{ V} \leq V_O \leq 12 \text{ V}$		-250	$\pm 70$	250	mA
$I_{CC}$	Supply current	No load, $V_I = 0$ or $V_{CC}$			8.5	15	mA

(1) All typical values are at  $V_{CC} = 5 \text{ V}$ ,  $T_A = 25^\circ\text{C}$ .

(2)  $\Delta |V_{OD}|$  and  $\Delta |V_{OC}|$  are the changes in the steady-state magnitude of  $V_{OD}$  and  $V_{OC}$ , respectively, that occur when the input is changed from a high level to a low level.

## DRIVER SWITCHING CHARACTERISTICS

over recommended operating conditions (unless otherwise noted)

PARAMETER		TEST CONDITIONS		MIN	TYP	MAX	UNIT
$t_{PLH}$	Propagation delay time, low-to-high-level output	$R_L = 54 \Omega$ , $C_L = 50 \text{ pF}$ , See <a href="#">Figure 3</a>		2	6	12	ns
$t_{PHL}$	Propagation delay time, high-to-low-level output			2	6	12	ns
$t_{sk(p)}$	Pulse skew ( $ t_{PHL} - t_{PLH} $ )				0.3	1	ns
$t_r$	Differential output signal rise time			4	7.5	11	ns
$t_f$	Differential output signal fall time			4	7.5	11	ns

## RECEIVER SECTION

### RECEIVER ELECTRICAL CHARACTERISTICS

over recommended operating conditions (unless otherwise noted)

PARAMETER	TEST CONDITIONS	MIN	TYP	MAX	UNIT
$V_{IT+}$ Positive-going input threshold voltage	$I_O = -8\text{ mA}$			0.2	V
$V_{IT-}$ Negative-going input threshold voltage	$I_O = 8\text{ mA}$	-0.2			
$V_{hys}$ Hysteresis voltage ( $V_{IT+} - V_{IT-}$ )			50		mV
$V_{OH}$ High-level output voltage	$V_{ID} = 200\text{ mV}$ , $I_{OH} = -8\text{ mA}$ , See Figure 1	4	4.9		V
$V_{OL}$ Low-level output voltage	$V_{ID} = -200\text{ mV}$ , $I_{OL} = 8\text{ mA}$ , See Figure 1		0.1	0.8	V
$I_I$ Bus input current	Other input at 0 V	$V_{IH} = 12\text{ V}$ , $V_{CC} = 5\text{ V}$	0.4	1	mA
		$V_{IH} = 12\text{ V}$ , $V_{CC} = 0$	0.5	1	
		$V_{IH} = -7\text{ V}$ , $V_{CC} = 5\text{ V}$	-0.8	-0.4	
		$V_{IH} = -7\text{ V}$ , $V_{CC} = 0$	-0.8	-0.3	

### RECEIVER SWITCHING CHARACTERISTICS

over recommended operating conditions (unless otherwise noted)

PARAMETER	TEST CONDITIONS	MIN	TYP	MAX	UNIT
$t_{PLH}$ Propagation delay time, low-to-high-level output	$V_{ID} = -1.5\text{ V to }1.5\text{ V}$ , See Figure 4	7	13	20	ns
$t_{PHL}$ Propagation delay time, high-to-low-level output		7	13	20	ns
$t_{sk(p)}$ Pulse skew ( $ t_{PLH} - t_{PHL} $ )		0.5	1.5		ns
$t_r$ Rise time, output		2.1	3.3		ns
$t_f$ Fall time, output		See Figure 4	2.1	3.3	ns

### PARAMETER MEASUREMENT INFORMATION

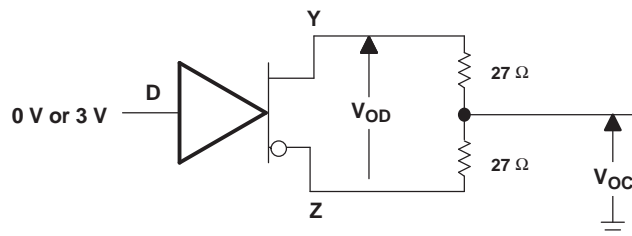

Figure 1. Driver  $V_{OD}$  and  $V_{OC}$

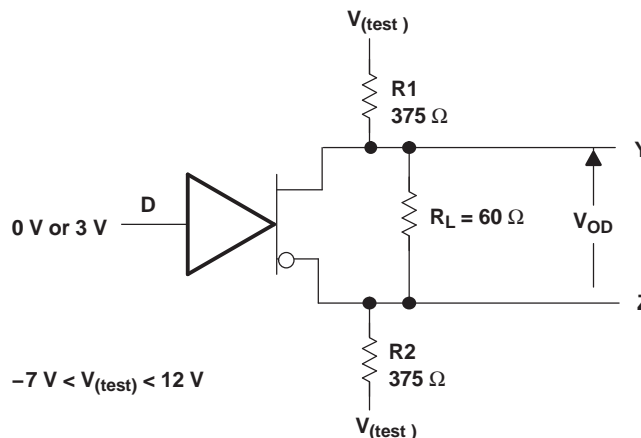
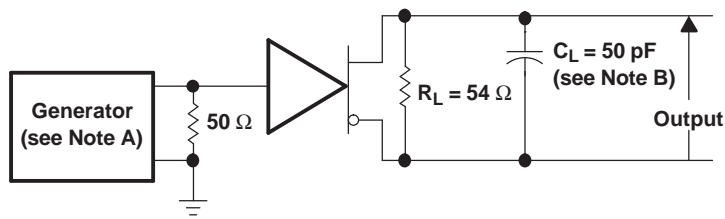
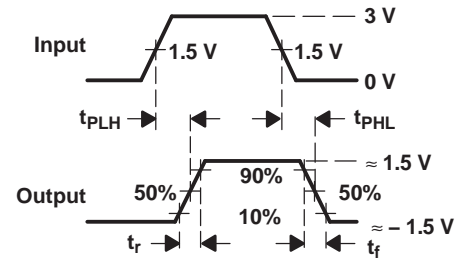

Figure 2. Driver  $V_{OD}$  With Common-Mode Loading

PARAMETER MEASUREMENT INFORMATION (continued)



TEST CIRCUIT



VOLTAGE WAVEFORMS

- A. The input pulse is supplied by a generator having the following characteristics:  $PRR \leq 1 \text{ MHz}$ , 50% duty cycle,  $t_r \leq 6 \text{ ns}$ ,  $t_f \leq 6 \text{ ns}$ ,  $Z_O = 50 \Omega$ .
- B.  $C_L$  includes probe and jig capacitance.

Figure 3. Driver Test Circuits and Voltage Waveforms

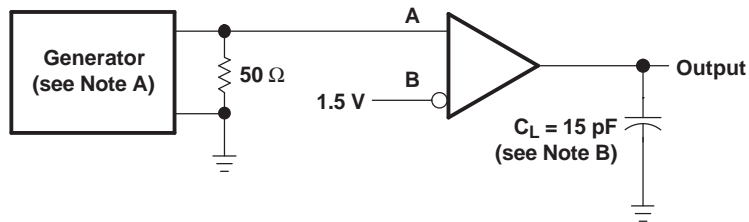

TEST CIRCUIT

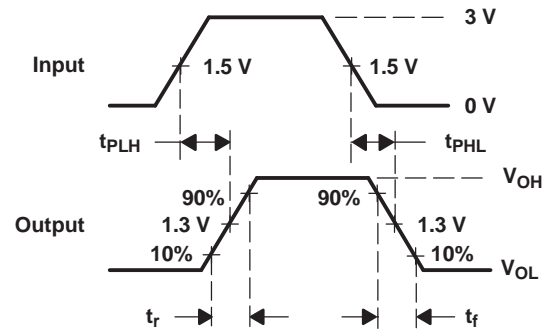

VOLTAGE WAVEFORMS

- A. The input pulse is supplied by a generator having the following characteristics:  $PRR \leq 1 \text{ MHz}$ , 50% duty cycle,  $t_r \leq 6 \text{ ns}$ ,  $t_f \leq 6 \text{ ns}$ ,  $Z_O = 50 \Omega$ .
- B.  $C_L$  includes probe and jig capacitance.

Figure 4. Receiver Test Circuit and Voltage Waveforms

TYPICAL CHARACTERISTICS

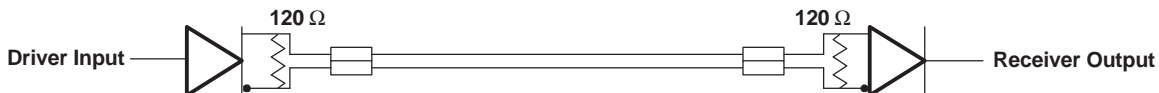
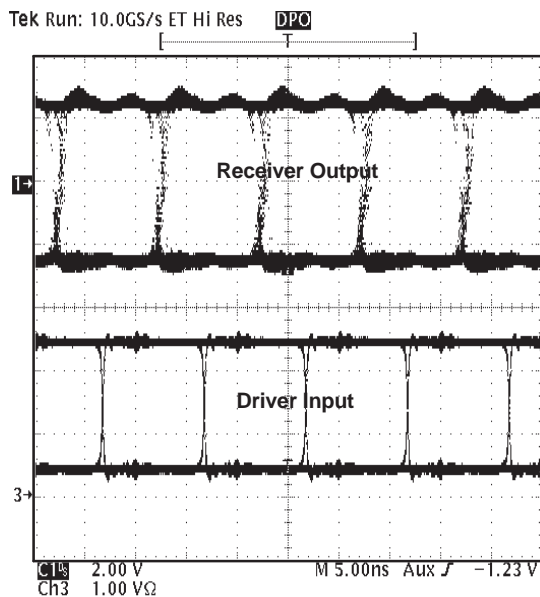

Figure 5. Typical Waveform of Non-Return-To-Zero (NRZ), Pseudorandom Binary Sequence (PRBS) Data at 100 Mbps Through 15m, of CAT 5 Unshielded Twisted Pair (UTP) Cable

TIA/EIA-485-A defines a maximum signaling rate as that in which the transition time of the voltage transition of a logic-state change remains less than or equal to 30% of the bit length. Transition times of greater length perform quite well even though they do not meet the standard by definition.

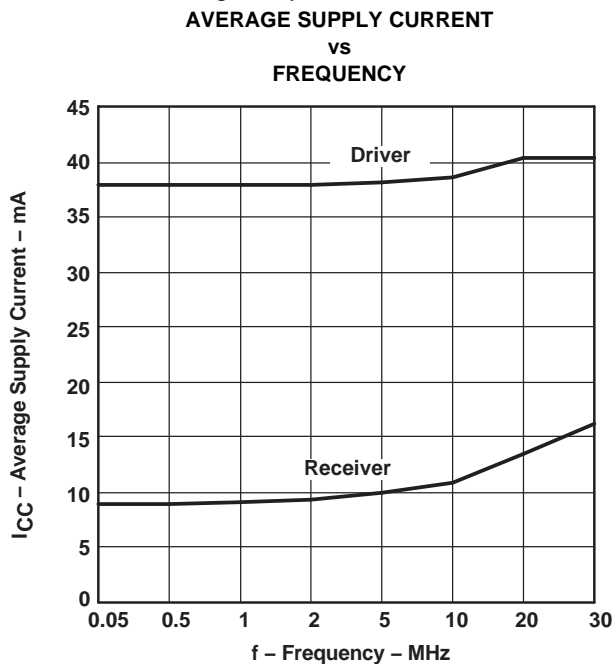

Figure 6.

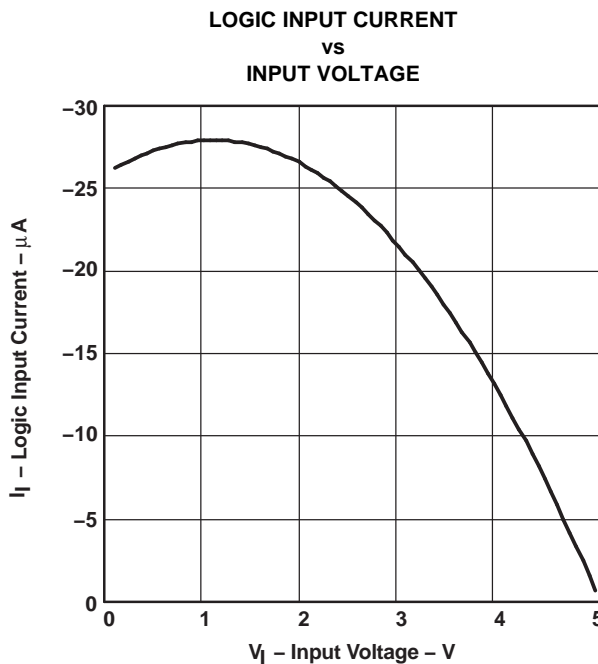

Figure 7.

**TYPICAL CHARACTERISTICS (continued)**

**INPUT CURRENT  
vs  
INPUT VOLTAGE**

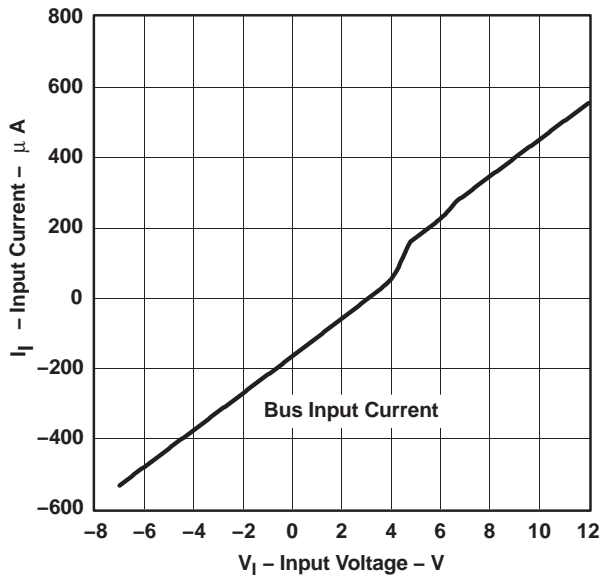

Figure 8.

**LOW-LEVEL OUTPUT VOLTAGE  
vs  
LOW-LEVEL OUTPUT CURRENT**

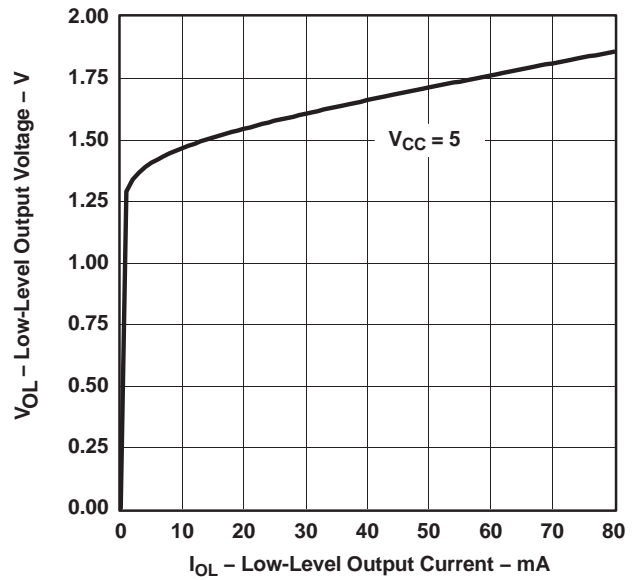

Figure 9.

**DRIVER HIGH-LEVEL OUTPUT VOLTAGE  
vs  
HIGH-LEVEL OUTPUT CURRENT**

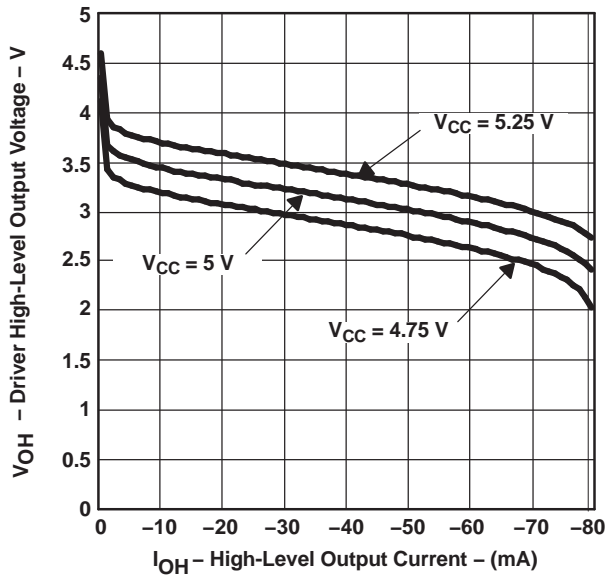

Figure 10.

**DRIVER DIFFERENTIAL OUTPUT VOLTAGE  
vs  
AVERAGE CASE TEMPERATURE**

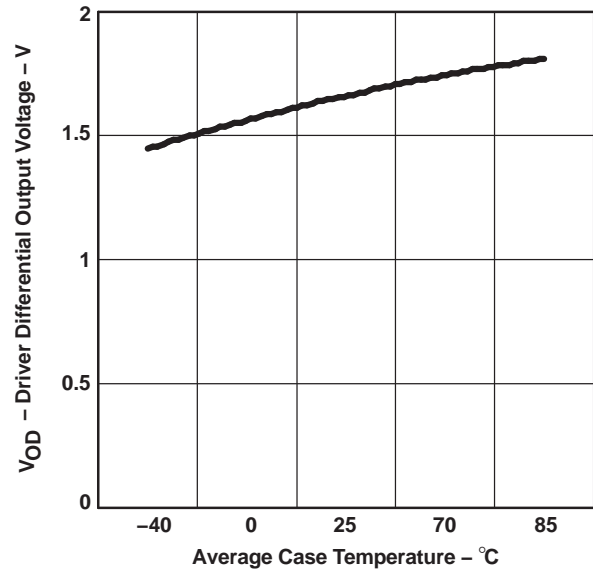

Figure 11.

TYPICAL CHARACTERISTICS (continued)

RECEIVER PROPAGATION TIME  
vs  
CASE TEMPERATURE

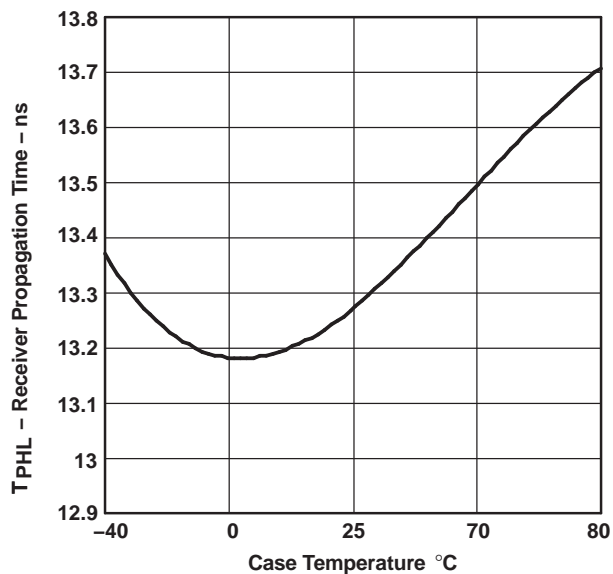

Figure 12.

DRIVER PROPAGATION DELAY TIME  
vs  
CASE TEMPERATURE

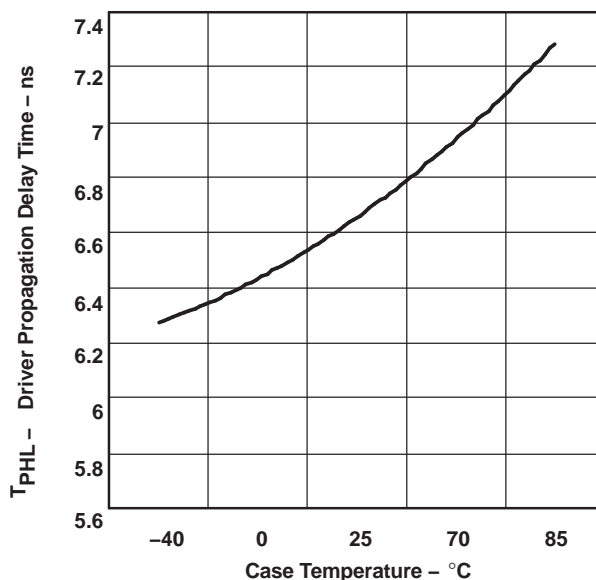

Figure 13.

DRIVER OUTPUT CURRENT  
vs  
SUPPLY VOLTAGE

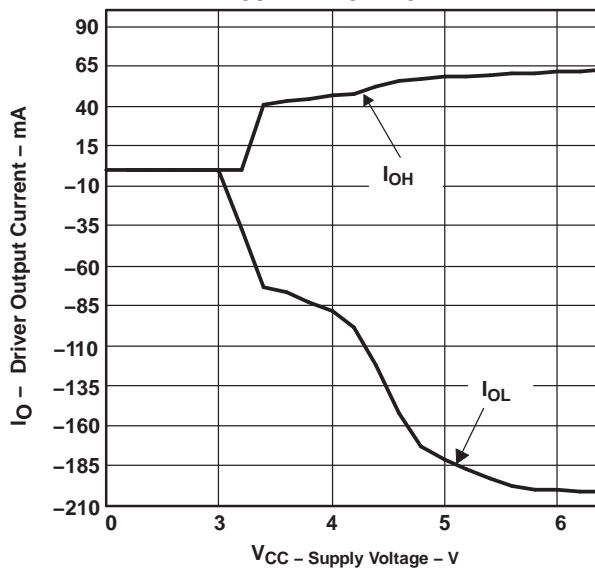

Figure 14.

## REVISION HISTORY

Changes from Revision C (June 2001) to Revision D	Page
• Changed the D Output and R Output schematins .....	2
• Added Receiver output current to the Abs Max Table .....	3
• Changed ESD - All terminals, Class 3, A From: 4 kV To: 3 kV .....	3

**PACKAGING INFORMATION**

Orderable Device	Status (1)	Package Type	Package Drawing	Pins	Package Qty	Eco Plan (2)	Lead/Ball Finish (6)	MSL Peak Temp (3)	Op Temp (°C)	Device Marking (4/5)	Samples
SN65LBC179AD	ACTIVE	SOIC	D	8	75	Green (RoHS & no Sb/Br)	CU NIPDAU	Level-1-260C-UNLIM	-40 to 85	BL179A	<a href="#">Samples</a>
SN65LBC179ADG4	ACTIVE	SOIC	D	8	75	Green (RoHS & no Sb/Br)	CU NIPDAU	Level-1-260C-UNLIM	-40 to 85	BL179A	<a href="#">Samples</a>
SN65LBC179ADR	ACTIVE	SOIC	D	8	2500	Green (RoHS & no Sb/Br)	CU NIPDAU	Level-1-260C-UNLIM	-40 to 85	BL179A	<a href="#">Samples</a>
SN65LBC179ADRG4	ACTIVE	SOIC	D	8	2500	Green (RoHS & no Sb/Br)	CU NIPDAU	Level-1-260C-UNLIM	-40 to 85	BL179A	<a href="#">Samples</a>
SN65LBC179AP	ACTIVE	PDIP	P	8	50	Green (RoHS & no Sb/Br)	CU NIPDAU	N / A for Pkg Type	-40 to 85	65LBC179A	<a href="#">Samples</a>
SN75LBC179AD	ACTIVE	SOIC	D	8	75	Green (RoHS & no Sb/Br)	CU NIPDAU	Level-1-260C-UNLIM	0 to 70	LB179A	<a href="#">Samples</a>
SN75LBC179ADG4	ACTIVE	SOIC	D	8	75	Green (RoHS & no Sb/Br)	CU NIPDAU	Level-1-260C-UNLIM	0 to 70	LB179A	<a href="#">Samples</a>
SN75LBC179ADR	ACTIVE	SOIC	D	8	2500	Green (RoHS & no Sb/Br)	CU NIPDAU	Level-1-260C-UNLIM	0 to 70	LB179A	<a href="#">Samples</a>
SN75LBC179ADRG4	ACTIVE	SOIC	D	8	2500	Green (RoHS & no Sb/Br)	CU NIPDAU	Level-1-260C-UNLIM	0 to 70	LB179A	<a href="#">Samples</a>
SN75LBC179AP	ACTIVE	PDIP	P	8	50	Green (RoHS & no Sb/Br)	CU NIPDAU	N / A for Pkg Type	0 to 70	75LBC179A	<a href="#">Samples</a>

(1) The marketing status values are defined as follows:

**ACTIVE:** Product device recommended for new designs.

**LIFEBUY:** TI has announced that the device will be discontinued, and a lifetime-buy period is in effect.

**NRND:** Not recommended for new designs. Device is in production to support existing customers, but TI does not recommend using this part in a new design.

**PREVIEW:** Device has been announced but is not in production. Samples may or may not be available.

**OBSOLETE:** TI has discontinued the production of the device.

(2) **RoHS:** TI defines "RoHS" to mean semiconductor products that are compliant with the current EU RoHS requirements for all 10 RoHS substances, including the requirement that RoHS substance do not exceed 0.1% by weight in homogeneous materials. Where designed to be soldered at high temperatures, "RoHS" products are suitable for use in specified lead-free processes. TI may reference these types of products as "Pb-Free".

**RoHS Exempt:** TI defines "RoHS Exempt" to mean products that contain lead but are compliant with EU RoHS pursuant to a specific EU RoHS exemption.

**Green:** TI defines "Green" to mean the content of Chlorine (Cl) and Bromine (Br) based flame retardants meet JS709B low halogen requirements of <=1000ppm threshold. Antimony trioxide based flame retardants must also meet the <=1000ppm threshold requirement.

(3) MSL, Peak Temp. - The Moisture Sensitivity Level rating according to the JEDEC industry standard classifications, and peak solder temperature.

(4) There may be additional marking, which relates to the logo, the lot trace code information, or the environmental category on the device.

(5) Multiple Device Markings will be inside parentheses. Only one Device Marking contained in parentheses and separated by a "~" will appear on a device. If a line is indented then it is a continuation of the previous line and the two combined represent the entire Device Marking for that device.

(6) Lead/Ball Finish - Orderable Devices may have multiple material finish options. Finish options are separated by a vertical ruled line. Lead/Ball Finish values may wrap to two lines if the finish value exceeds the maximum column width.

**Important Information and Disclaimer:**The information provided on this page represents TI's knowledge and belief as of the date that it is provided. TI bases its knowledge and belief on information provided by third parties, and makes no representation or warranty as to the accuracy of such information. Efforts are underway to better integrate information from third parties. TI has taken and continues to take reasonable steps to provide representative and accurate information but may not have conducted destructive testing or chemical analysis on incoming materials and chemicals. TI and TI suppliers consider certain information to be proprietary, and thus CAS numbers and other limited information may not be available for release.

In no event shall TI's liability arising out of such information exceed the total purchase price of the TI part(s) at issue in this document sold by TI to Customer on an annual basis.

## TAPE AND REEL INFORMATION

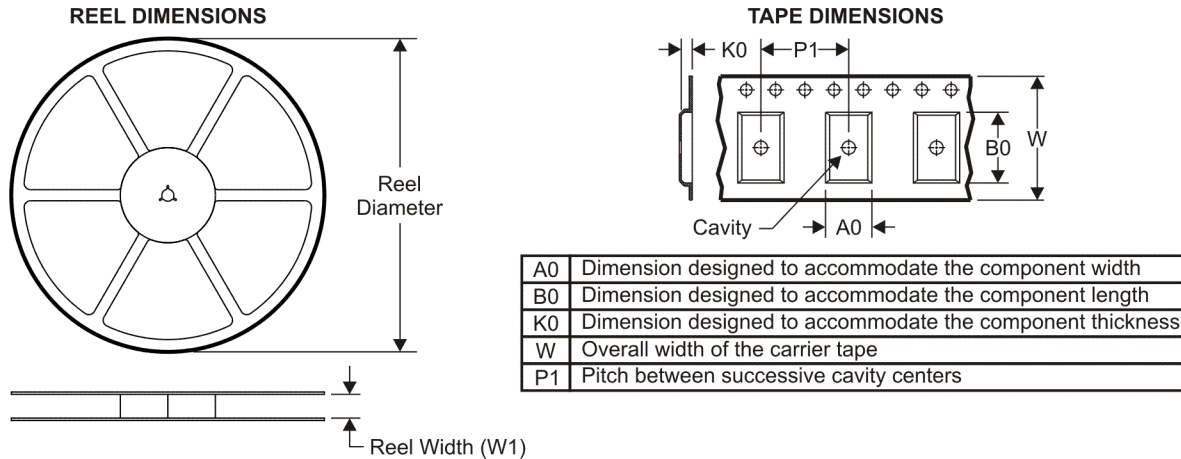

### QUADRANT ASSIGNMENTS FOR PIN 1 ORIENTATION IN TAPE



\*All dimensions are nominal

Device	Package Type	Package Drawing	Pins	SPQ	Reel Diameter (mm)	Reel Width W1 (mm)	A0 (mm)	B0 (mm)	K0 (mm)	P1 (mm)	W (mm)	Pin1 Quadrant
SN65LBC179ADR	SOIC	D	8	2500	330.0	12.4	6.4	5.2	2.1	8.0	12.0	Q1
SN75LBC179ADR	SOIC	D	8	2500	330.0	12.4	6.4	5.2	2.1	8.0	12.0	Q1

**TAPE AND REEL BOX DIMENSIONS**

\*All dimensions are nominal

Device	Package Type	Package Drawing	Pins	SPQ	Length (mm)	Width (mm)	Height (mm)
SN65LBC179ADR	SOIC	D	8	2500	340.5	338.1	20.6
SN75LBC179ADR	SOIC	D	8	2500	340.5	338.1	20.6



D0008A

# PACKAGE OUTLINE

SOIC - 1.75 mm max height

SMALL OUTLINE INTEGRATED CIRCUIT



4214825/C 02/2019

NOTES:

1. Linear dimensions are in inches [millimeters]. Dimensions in parenthesis are for reference only. Controlling dimensions are in inches. Dimensioning and tolerancing per ASME Y14.5M.
2. This drawing is subject to change without notice.
3. This dimension does not include mold flash, protrusions, or gate burrs. Mold flash, protrusions, or gate burrs shall not exceed  $.006$  [0.15] per side.
4. This dimension does not include interlead flash.
5. Reference JEDEC registration MS-012, variation AA.

# EXAMPLE BOARD LAYOUT

D0008A

SOIC - 1.75 mm max height

SMALL OUTLINE INTEGRATED CIRCUIT



LAND PATTERN EXAMPLE  
 EXPOSED METAL SHOWN  
 SCALE:8X



SOLDER MASK DETAILS

4214825/C 02/2019

NOTES: (continued)

- 6. Publication IPC-7351 may have alternate designs.
- 7. Solder mask tolerances between and around signal pads can vary based on board fabrication site.

# EXAMPLE STENCIL DESIGN

D0008A

SOIC - 1.75 mm max height

SMALL OUTLINE INTEGRATED CIRCUIT



SOLDER PASTE EXAMPLE  
BASED ON .005 INCH [0.125 MM] THICK STENCIL  
SCALE:8X

4214825/C 02/2019

NOTES: (continued)

8. Laser cutting apertures with trapezoidal walls and rounded corners may offer better paste release. IPC-7525 may have alternate design recommendations.
9. Board assembly site may have different recommendations for stencil design.

P (R-PDIP-T8)

PLASTIC DUAL-IN-LINE PACKAGE



- NOTES:
- A. All linear dimensions are in inches (millimeters).
  - B. This drawing is subject to change without notice.
  - C. Falls within JEDEC MS-001 variation BA.

## IMPORTANT NOTICE AND DISCLAIMER

TI PROVIDES TECHNICAL AND RELIABILITY DATA (INCLUDING DATASHEETS), DESIGN RESOURCES (INCLUDING REFERENCE DESIGNS), APPLICATION OR OTHER DESIGN ADVICE, WEB TOOLS, SAFETY INFORMATION, AND OTHER RESOURCES "AS IS" AND WITH ALL FAULTS, AND DISCLAIMS ALL WARRANTIES, EXPRESS AND IMPLIED, INCLUDING WITHOUT LIMITATION ANY IMPLIED WARRANTIES OF MERCHANTABILITY, FITNESS FOR A PARTICULAR PURPOSE OR NON-INFRINGEMENT OF THIRD PARTY INTELLECTUAL PROPERTY RIGHTS.

These resources are intended for skilled developers designing with TI products. You are solely responsible for (1) selecting the appropriate TI products for your application, (2) designing, validating and testing your application, and (3) ensuring your application meets applicable standards, and any other safety, security, or other requirements. These resources are subject to change without notice. TI grants you permission to use these resources only for development of an application that uses the TI products described in the resource. Other reproduction and display of these resources is prohibited. No license is granted to any other TI intellectual property right or to any third party intellectual property right. TI disclaims responsibility for, and you will fully indemnify TI and its representatives against, any claims, damages, costs, losses, and liabilities arising out of your use of these resources.

TI's products are provided subject to TI's Terms of Sale ([www.ti.com/legal/termsofsale.html](http://www.ti.com/legal/termsofsale.html)) or other applicable terms available either on [ti.com](http://ti.com) or provided in conjunction with such TI products. TI's provision of these resources does not expand or otherwise alter TI's applicable warranties or warranty disclaimers for TI products.

Mailing Address: Texas Instruments, Post Office Box 655303, Dallas, Texas 75265  
Copyright © 2019, Texas Instruments Incorporated

## Looking for pricing, stock, or lifecycle information?

Click below to explore more details on WIN SOURCE:

 [View SN65LBC179ADR on WIN SOURCE](#)

 [Texas Instruments](#) Information

## Optimize Your Supply Chain with WIN SOURCE Solutions

-  Global Sourcing Solution
-  Obsolete Management
-  Cost Control Management
-  Shortage Management
-  Alternative Solution
-  Excess Inventory Management