



THE DATASHEET OF LMX2216M



LMX2216

*LMX2216 0.1 GHz to 2.0 GHz Low Noise Amplifier/Mixer for RF Personal
Communications*



Literature Number: SNOS689A

LMX2216

0.1 GHz to 2.0 GHz Low Noise Amplifier/Mixer for RF Personal Communications

General Description

The LMX2216 is a monolithic, integrated low noise amplifier (LNA) and mixer suitable as a first stage amplifier and down-converter for RF receiver applications. The wideband operating capabilities of the LMX2216 allow it to function over frequencies from 0.1 GHz to 2.0 GHz. It is fabricated using National Semiconductor's ABiC IV BiCMOS process.

All input and output ports of the LMX2216 are single-ended. The LNA input and output ports are designed to interface to a 50Ω system. The Mixer input ports are matched to 50Ω . The output port is matched to 200Ω . The only external components required are DC blocking capacitors. The balanced architecture of the LMX2216 maintains consistent operating parameters from unit to unit, since it is implemented in a monolithic device. This consistency provides manufacturers a significant advantage since tuning procedures—often needed with discrete designs—can be reduced or eliminated.

The low noise amplifier produces very flat gain over the entire operating range. The doubly-balanced, Gilbert-cell mixer provides good LO-RF isolation and cancellation of second-order distortion products. A power down feature is implemented on the LMX2216 that is especially useful for stand-by operation common in Time Division Multiple Access (TDMA) and Time Division Duplex (TDD) systems.

The LMX2216 is available in a narrow-body 16-pin surface mount plastic package.

Features

- Wideband RF operation from 0.1 GHz to 2.0 GHz
- No external biasing components necessary
- 3V operation
- LNA input and output ports matched to 50Ω
- Mixer input ports matched to 50Ω , output port matched to 200Ω .
- Doubly balanced Gilbert cell mixer (single ended input and output)
- Low power consumption
- Power down feature
- Small outline, plastic surface mount package

Applications

- Digital European Cordless Telecommunications (DECT)
- Portable wireless communications (PCS/PCN, cordless)
- Wireless local area networks (WLANs)
- Digital cellular telephone systems
- Other wireless communications systems

Functional Block/Pin Diagram

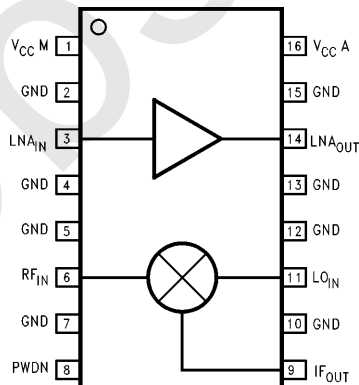

Order Number LMX2216M
See NS Package Number M16A

LMX2216 0.1 GHz to 2.0 GHz Low Noise Amplifier/Mixer for RF Personal Communications

Pin Description

Pin No.	Pin Name	I/O	Description
1	V _{CC M}	I	Voltage supply for the mixer. The input voltage level to this pin should be a DC Voltage ranging from 2.85V to 3.15V.
2	GND		Ground
3	LNA _{IN}	I	RF input signal to the LNA. External DC blocking capacitor is required.
4	GND		Ground
5	GND		Ground
6	RF _{IN}	I	RF input to the mixer. The RF signal to be down converted is connected to this pin. External DC blocking capacitor is required.
7	GND		Ground
8	PWDN	I	Power down signal pin. Both the LNA and mixer are powered down when a HIGH level is applied to this pin (V _{IH}).
9	IF _{OUT}	O	IF output signal of the mixer. External DC blocking capacitor is required.
10	GND		Ground
11	LO _{IN}	I	Local oscillator input signal to the mixer. External DC blocking capacitor is required.
12	GND		Ground
13	GND		Ground
14	LNA _{OUT}	O	Output of the LNA. This pin outputs the amplified RF signal. External DC blocking capacitor is required.
15	GND		Ground
16	V _{CC A}	I	LNA supply Voltage. DC Voltage ranging from 2.85V to 3.15V.

Absolute Maximum Ratings

If Military/Aerospace specified devices are required, please contact the National Semiconductor Sales Office/Distributors for availability and specifications.

Supply Voltage (V _{CC})	6.5V
Storage Temperature (T _S)	-65°C to +150°C
Operating Temperature (T _O)	-40°C to +85°C

Recommended Operating Conditions

Supply Voltage (V _{CC})	2.85V–3.15V
Operating Temperature (T _A)	-10°C to +70°C
RF _{IN}	0.1 GHz to 2.0 GHz
LO _{IN}	0.1 GHz to 2.0 GHz

Electrical Characteristics: LNA

($V_{CC} = +3.0V \pm 5\%$, $T_A = 25^\circ C$, $Z_o = 50\Omega$ and $f_{IN} = 2.0\text{ GHz} @ -30\text{ dBm}$ unless otherwise specified.)

Symbol	Parameter	Conditions	Min	Typ	Max	Units
I_{CC}	Supply Current	In Operation		6.5	8.0	mA
$I_{CC-PWDN}$	Supply Current	In Power Down Mode			10	μA
G	Gain		9	10		dB
P_{1dB}	Output 1 dB Compression Point		-5.0	-3.0		dBm
OIP3	Output 3rd Order Intercept Point		5.0	7.0		dBm
NF	Single Side Band Noise Figure			4.8	6.0	dB
RL_{IN}	Input Return Loss		10	15		dB
RL_{OUT}	Output Return Loss		10	11		dB

Electrical Characteristics: Mixer ($V_{CC} = +3.0V \pm 5\%$, $T_A = 25^\circ C$, $Z_o = 50\Omega$, $f_{RF} = 2.0\text{ GHz} @ -30\text{ dBm}$, $f_{LO} = 1.89\text{ GHz} @ 0\text{ dBm}$; $f_{IF} = 110\text{ MHz}$ unless otherwise specified.)

Symbol	Parameter	Conditions	Min	Typ	Max	Units
I_{CC}	Supply Current	In Operation		9.0	12.0	mA
$I_{CC-PWDN}$	Supply Current	In Power Down Mode			10	μA
G_C	Conversion Gain (Single Side Band)		4.0	6.0		dB
P_{1dB}	Output 1 dB Compression Point		-13.0	-9.0		dBm
OIP3	Output Third Order Intercept Point		-3.0	0.0		dBm
SSB NF	Single Side Band Noise Figure			17	18	dB
DSB NF	Double Side Band Noise Figure			14	15	dB
LO-RF	LO to RF Isolation		20	30		dB
LO-IF	LO to IF Isolation		20	30		dB
RF RL	RF Return Loss		10	15		dB
LO RL	LO Return Loss		10	15		dB
IF RL	IF Return Loss			15		dB
Z_{IF}	IF Port Impedance			200		Ω

Electrical Characteristics: Power Down

Symbol	Parameter	Conditions	Min	Typ	Max	Units
V_{IH}	High Level Input Voltage		$V_{CC} - 0.8$			V
V_{IL}	Low Level Input Voltage				0.8	V
I_{IH}	High Level Input Current	$V_{IH} = V_{CC}$	-10.0		10.0	μA
I_{IL}	Low Level Input Current	$V_{IL} = GND$	-10.0		10.0	μA

Typical Application Block Diagram

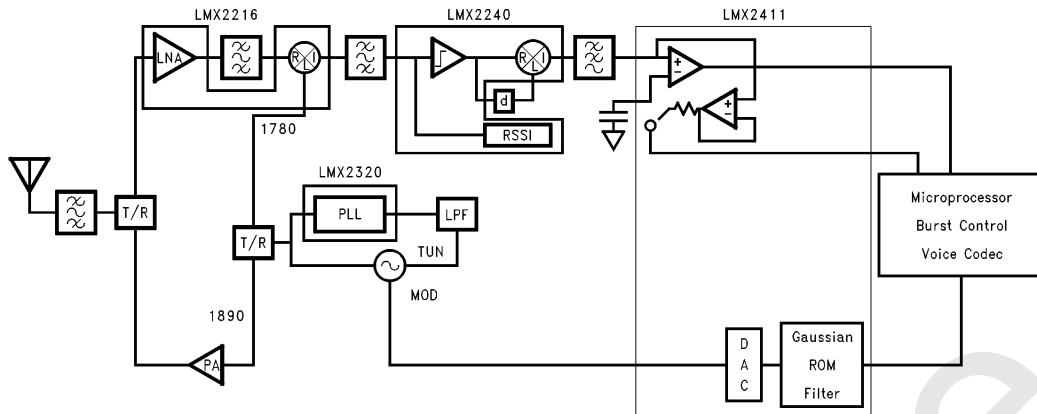

FIGURE 2

TL/W/11814-2

Typical Characteristics

LNA

LNA Current Composition vs Supply Voltage with Temperature as a Parameter

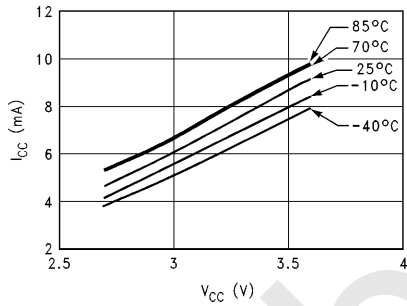

TL/W/11814-3

LNA P_{OUT} vs P_{IN} with Supply Voltage as a Parameter

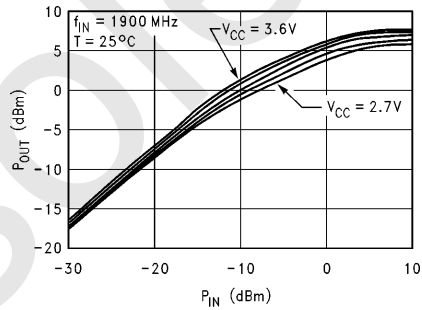

TL/W/11814-4

LNA P_{OUT} vs P_{IN} with Temperature as a Parameter

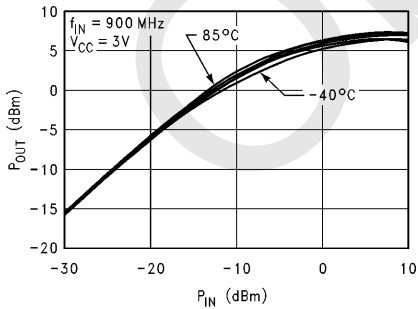

TL/W/11814-6

LNA P_{OUT} vs P_{IN} with Temperature as a Parameter

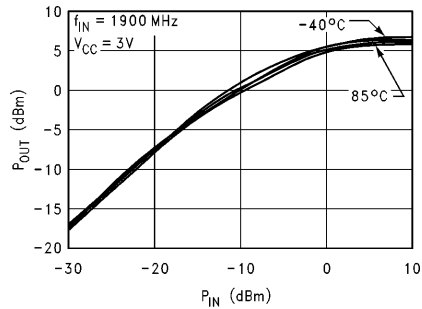

TL/W/11814-7

Typical Characteristics (Continued)

LNA (Continued)

LNA Gain vs Frequency with Supply Voltage as a Parameter

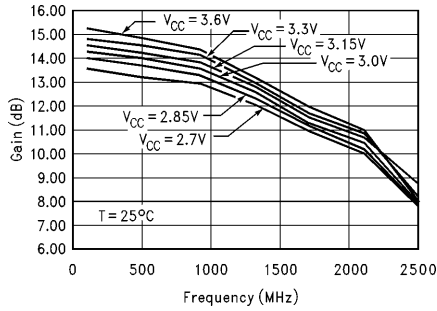

TL/W/11814-8

LNA Noise Figure vs Frequency with Supply Voltage as a Parameter

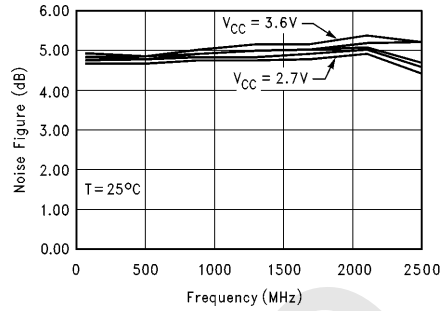

TL/W/11814-9

LNA Gain vs Frequency with Temperature as a Parameter

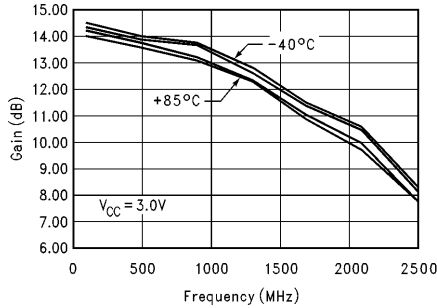

TL/W/11814-10

LNA Noise Figure vs Frequency with Temperature as a Parameter

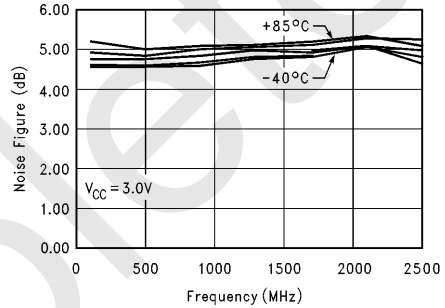

TL/W/11814-11

LNA Input Return Loss vs Frequency with Voltage as a Parameter

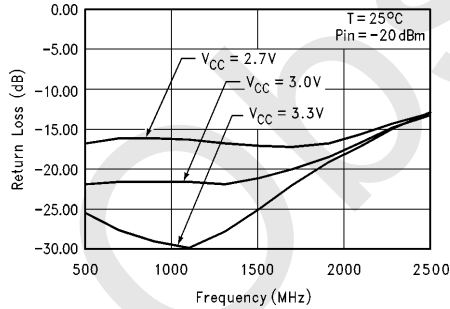

TL/W/11814-12

LNA Output Return Loss vs Frequency with Voltage as a Parameter

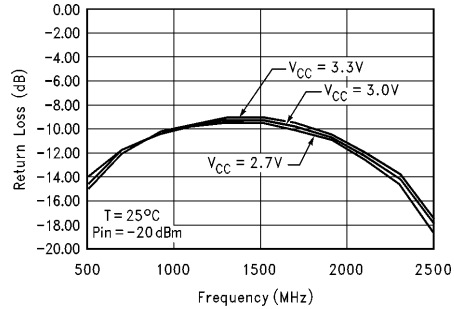

TL/W/11814-19

Typical Characteristics (Continued)

MIXER

**Mixer Gain (Double Sideband)
vs Frequency with Supply
Voltage as a Parameter**

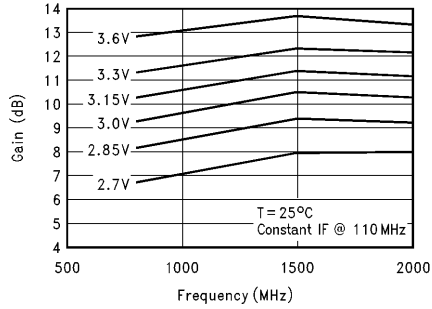

TL/W/11814-20

**Mixer Gain (Double Sideband)
vs Frequency with Temperature
as a Parameter**

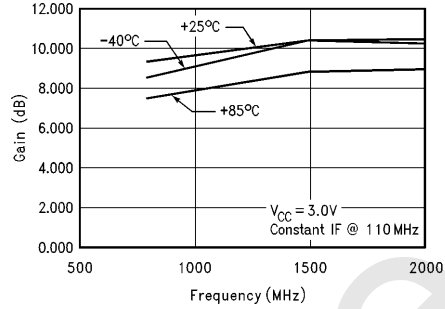

TL/W/11814-21

**Mixer Noise Figure (Double Sideband)
vs Frequency with Supply
Voltage as a Parameter**

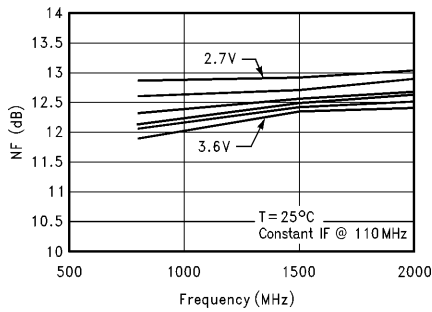

TL/W/11814-22

**Mixer Noise Figure (Double Sideband)
vs Frequency with Temperature
as a Parameter**

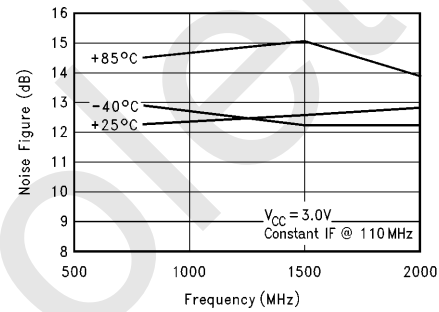

TL/W/11814-23

Typical Characteristics (Continued)

MIXER (Continued)

Mixer P_{OUT} vs P_{IN} with Supply Voltage as a Parameter

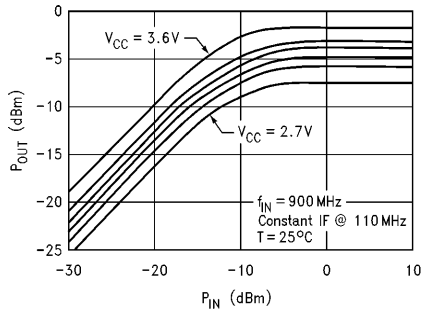

TL/W/11814-24

Mixer P_{OUT} vs P_{IN} with Supply Voltage as a Parameter

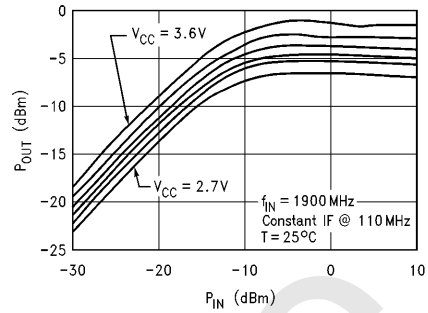

TL/W/11814-25

Mixer P_{OUT} vs P_{IN} with Temperature as a Parameter

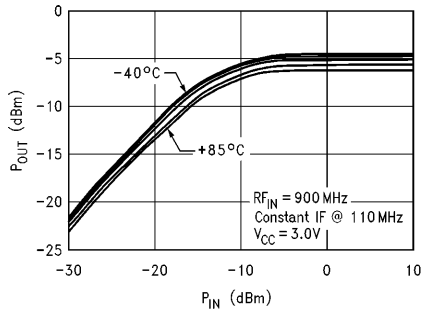

TL/W/11814-26

Mixer P_{OUT} vs P_{IN} with Temperature as a Parameter

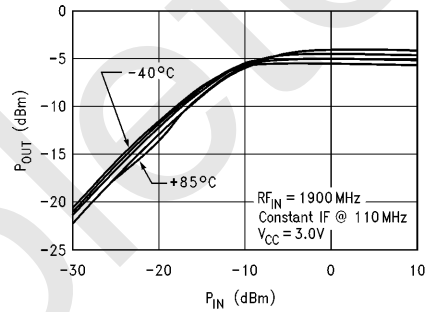

TL/W/11814-27

Mixer RF_{IN} Return Loss vs Frequency with Supply Voltage as a Parameter

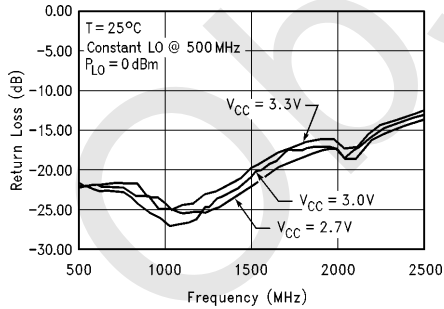

TL/W/11814-28

Mixer RF_{IN} Return Loss vs Frequency with Supply Voltage as a Parameter

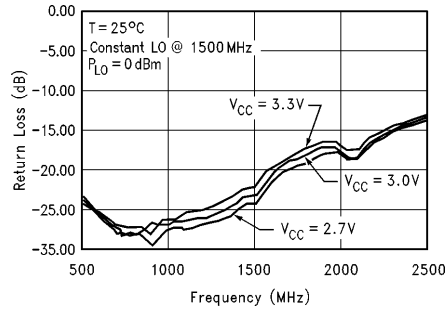

TL/W/11814-29

Functional Description (Continued)

THE LNA

The LNA is a common emitter stage with active feedback. This feedback network allows for wide bandwidth operation while providing the necessary optimal input impedance for low noise performance. The power down feature is implemented using a CMOS buffer and a power-down switch. The power down switch is implemented with CMOS devices. During power down, the switch is open and only leakage currents are drawn from the supply.

THE MIXER

The mixer is a Gilbert cell architecture, with the RF input signal modulating the LO signal and single ended output taken from the collector of one of the upper four transistors. The power down circuitry of the mixer is similar to that of the LNA. The power down switch is used to provide or cut off bias to the Gilbert cell.

Typical Low Noise Amplifier

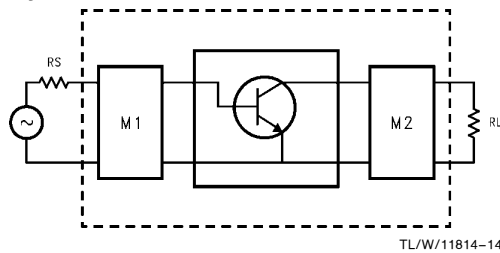

FIGURE 4. Typical LNA Structure

A typical low noise amplifier consists of an active amplifying element and input and output matching networks. The input matching network is usually optimized for noise performance, and the output matching network for gain. The active element is chosen such that it has the lowest optimal noise figure, F_{MIN} , an intrinsic property of the device. The noise figure of a linear two-port is a function of the source admittance and can be expressed by

$$F = F_{MIN} + \frac{R_n}{G_G} [(G_{ON} - G_G)^2 + (B_{ON} - B_G)^2]$$

where $G_G + jB_G$ = generator admittance presented to the input of the two port,

$G_{ON} + jB_{ON}$ = generator admittance at which optimum noise figure occurs,

R_n = empirical constant relating the sensitivity of the noise figure to generator admittance.

Typical Gilbert Cell

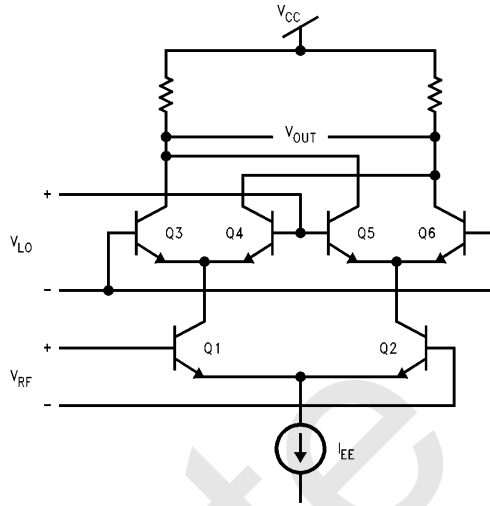

FIGURE 5. Typical Gilbert Cell Circuit Diagram

The Gilbert cell shown above is a circuit which multiplies two input signals, RF and LO. The input RF voltage differentially modulates the currents on the collectors of the transistors Q1 and Q2, which in turn modulate the LO voltage by varying the bias currents of the transistors Q3, Q4, Q5, and Q6. Assuming that the two signals are small, the result is a product of the two signals, producing at the output a sum and difference of the frequencies of the two input signals. If either of these two signals are much larger than the threshold voltage V_T , the output will contain other mixing products and higher order terms which are undesirable and may need to be attenuated or filtered out.

Analysis of the Gilbert cell shows that the output, which is the difference of the collector currents of Q3 and Q6, is related to the two inputs by the equation:

$$\Delta I = I_{C3} - I_{C6} = I_{EE} \left[\tanh \left(\frac{V_{RF}}{2V_T} \right) \right] \left[\tanh \left(\frac{V_{LO}}{2V_T} \right) \right]$$

and the hyperbolic tangent function can be expressed as a Taylor series

$$\tanh(x) = x - \frac{x^3}{3} + \frac{x^5}{5} - \dots$$

Assuming that the RF and LO signals are sinusoids.

$$V_{RF} = A \cos(\omega_{RF} t + \phi_{RF})$$

$$V_{LO} = B \cos(\omega_{LO} t + \phi_{LO})$$

then

$$\Delta I = I_{EE} \left[A \cos(\omega_{RF} t + \phi_{RF}) - \frac{A^3}{3} \cos^3(\omega_{RF} t + \phi_{RF}) + \dots \right] \\ \cdot \left[B \cos(\omega_{LO} t + \phi_{LO}) - \frac{B^3}{3} \cos^3(\omega_{LO} t + \phi_{LO}) + \dots \right]$$

The lowest order term is a product of two sinusoids, yielding a sum of two sinusoids,

$$I_{EE} \frac{AB}{2} \left[\cos((\omega_{RF} + \omega_{LO}) t + \phi_{RF} + \phi_{LO}) \right. \\ \left. + \cos((\omega_{RF} - \omega_{LO}) t + \phi_{RF} - \phi_{LO}) \right]$$

one of which is the desired intermediate frequency signal.

Figures of Merit

GAIN (G)

Many different types of gain are specified in RF engineering. The type referred to here is called transducer gain and is defined as the ratio of the power delivered to the load to the available power from the source,

$$G = \frac{P_{OUT}}{P_{IN}} = \frac{V_{OUT}^2/R_L}{V_{IN}^2/R_S} = 4 \frac{R_S}{R_L} \frac{V_{OUT}^2}{V_{IN}^2}$$

where V_{OUT} is the voltage across the load R_L and V_{IN} is the generator voltage with internal resistance R_S . In terms of scattering parameters, transducer gain is defined as

$$G = 20 \log (|S_{21}|)$$

where S_{21} is the forward transmission parameter, which can be measured using a network analyzer.

1 dB COMPRESSION POINT (P_{1dB})

A measure of amplitude linearity, 1 dB compression point is the point at which the actual gain is 1 dB below the ideal linear gain. For a memoryless two-port with weak nonlinearity, the output can be represented by a power series of the input as

$$v_o = k_1 v_i + k_2 v_i^2 + k_3 v_i^3 + \dots$$

For a sinusoidal input,

$$v_i = A \cos \omega_1 t$$

the output is

$$v_o = \frac{1}{2} k_2 A^2 + \left(k_1 A + \frac{3}{4} k_3 A^3 \right) \cos \omega_1 t + \frac{1}{2} k_2 A^2 \cos 2\omega_1 t + \frac{1}{4} k_3 A^3 \cos 3\omega_1 t$$

assuming that all of the fourth and higher order terms are negligible. For an amplifier, the fundamental component is the desired output, and it can be rewritten as

$$k_1 A \left[1 + \frac{3}{4} (k_3/k_1) A^2 \right].$$

This fundamental component is larger than $k_1 A$ (the ideally linear gain) if $k_3 > 0$ and smaller if $k_3 < 0$. For most practical devices, $k_3 < 0$, and the gain compresses as the amplitude A of the input signal gets larger. The 1 dB compression point can be expressed in terms of either the input power or the output power. Measurement of P_{1dB} can be made by increasing the input power while observing the output power until the gain is compressed by 1 dB.

THIRD ORDER INTERCEPT (OIP_3)

Third order intercept is another figure of merit used to characterize the linearity of a two-port. It is defined as the point at which the third order intermodulation product equals the ideal linear, uncompressed, output. Unlike the P_{1dB} , OIP_3 involves two input signals. However, it can be shown mathematically (similar derivation as above) that the two are closely related and $OIP_3 \approx P_{1dB} + 10$ dB. These two figures of merit are illustrated in *Figure 6*.

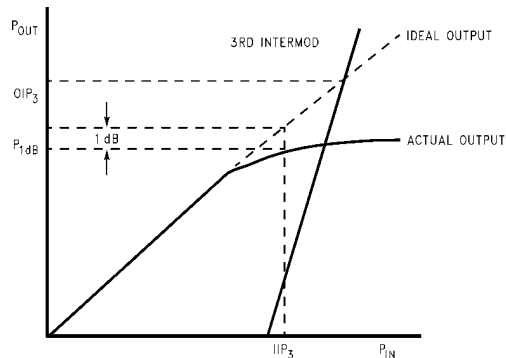

TL/W/11814-16

FIGURE 6. Typical P_{OUT} - P_{IN} Characteristics

NOISE FIGURE (NF)

Noise figure is defined as the input signal to noise ratio, divided by the output signal to noise ratio. For an amplifier, it can also be interpreted as the amount of noise introduced by the amplifier itself seen at the output. Mathematically,

$$F = \frac{S_i/N_i}{S_o/N_o} = \frac{S_i/N_i}{G_a S_i / (N_a + G_a N_i)} = \frac{N_a + G_a N_i}{G_a N_i}$$

$$NF = 10 \log (F)$$

where S_i and N_i represent the signal and noise power levels available at the input to the amplifier, S_o and N_o the signal and noise power levels available at the output, G_a the available gain, and N_a the noise added by the amplifier. Noise figure is an important figure of merit used to characterize the performance of not only a single component but also the entire system. It is one of the factors which determine the system sensitivity.

IMAGE FREQUENCY, DSB/SSB NF

Image frequency refers to that frequency which is also down-converted by the mixer, along with the desired RF component, to the intermediate frequency. This image frequency is located at the same distance away from the LO, but on the opposite side of the RF. For most mixers, it must be filtered out before the signal is down-converted; otherwise, an image-reject mixer must be used. *Figure 7* illustrates the concept.

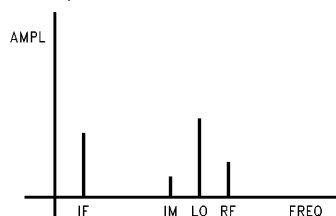

TL/W/11814-17

FIGURE 7. Input and Output Spectrum of Mixers

Figures of Merit (Continued)

Due to the presence of image frequencies and the method in which noise figure is defined, noise figures can be measured and specified in two ways: double side band (DSB) or single side band (SSB). In DSB measurements, the image frequency component of the input noise source is not filtered and contributes to the total output noise at the intermediate frequency. In SSB measurements, the image frequency is filtered and the output noise is not caused by this frequency component. In most mixer applications where only one side band is wanted, SSB noise figure is 3 dB higher than DSB noise figure.

In this application, the LMX2216 is used in a radio receiver front end, where it amplifies the signal from the antenna and then down converts it to an intermediate frequency. The image filter placed between the LNA and the mixer attenuates the image frequency.

The mixer is shown to use an LO signal generated by a PLL synthesizer, but, depending on the type of application, the LO signal could be generated by a device as simple as a free-running oscillator. The IF output is then typically filtered by a channel-select filter following the mixer, and this signal can then be demodulated or go through another down conversion, depending upon the intermediate frequency and system requirements. This external filter rejects adjacent channels and also attenuates any LO feed through. Figure 9 shows a cascade analysis of a typical RF front-end subsystem in which the LMX2216 is used. It includes the bandpass filter and the switch through which the input RF signal goes in a radio system before reaching the LNA. Typical values are used for the insertion loss of the various filters in this example.

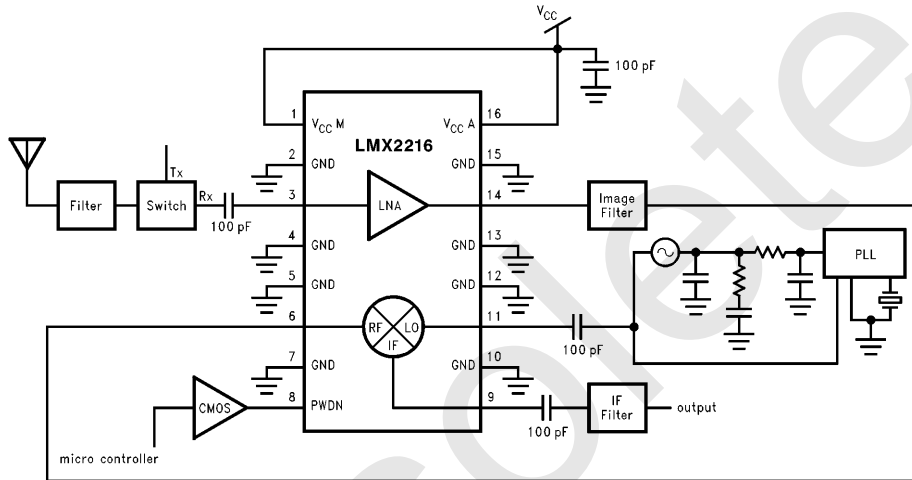

FIGURE 8. Typical Applications Circuit of the LMX2216

TL/W/11814-18

# Comp	Data per Stage			#	Cumulative Data				
	Gain	N Fig	OIP3		Gain	N Fig	IIP3	OIP3	
1	Filter	-2.0	2.0	100.0	1	-2.0	2.0	97.9	95.9
2	Switch	-0.6	0.6	100.0	2	-2.6	2.6	96.6	94.0
3	LNA	12.3	3.7	6.0	3	9.7	6.3	-3.7	6.0
4	Filter	-3.0	3.0	100.0	4	6.7	6.4	-3.7	3.0
5	Mixer	5.8	13.7	3.0	5	12.5	9.6	-10.5	2.0
6	Filter	-3.0	3.0	100.0	6	9.5	9.7	-10.5	-1.0
System Cumulative Values		Gain	9.5 dB						
		N Fig	9.7 dB						
		IIP ₃	-10.5 dBm						
		OIP ₃	-1.0 dBm						

FIGURE 9. Cascade Analysis Example

Physical Dimensions inches (millimeters)

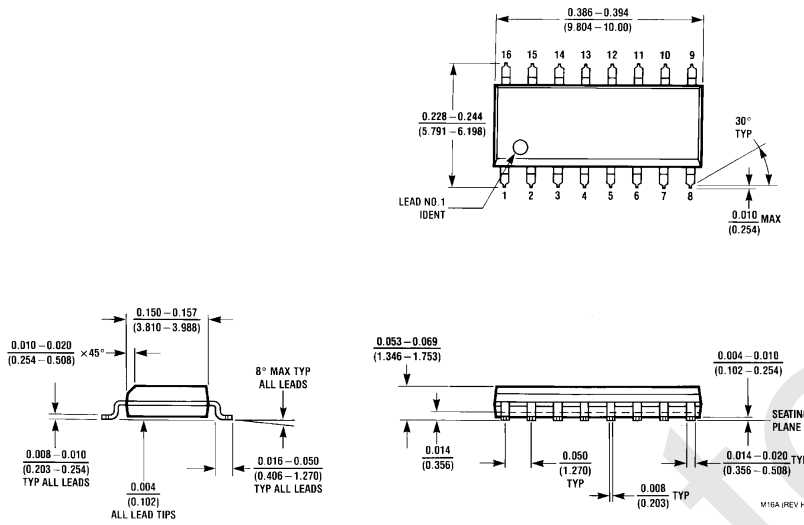

JEDEC 16-Lead (0.150" Wide) Small Outline Molded Package (M)
Order Number LMX2216M
For Tape and Reel Order Number LMX2216MX
NS Package Number M16A

LIFE SUPPORT POLICY

NATIONAL'S PRODUCTS ARE NOT AUTHORIZED FOR USE AS CRITICAL COMPONENTS IN LIFE SUPPORT DEVICES OR SYSTEMS WITHOUT THE EXPRESS WRITTEN APPROVAL OF THE PRESIDENT OF NATIONAL SEMICONDUCTOR CORPORATION. As used herein:

1. Life support devices or systems are devices or systems which, (a) are intended for surgical implant into the body, or (b) support or sustain life, and whose failure to perform, when properly used in accordance with instructions for use provided in the labeling, can be reasonably expected to result in a significant injury to the user.
2. A critical component is any component of a life support device or system whose failure to perform can be reasonably expected to cause the failure of the life support device or system, or to affect its safety or effectiveness.



National Semiconductor Corporation
 1111 West Bardin Road
 Arlington, TX 76017
 Tel: 1(800) 272-9959
 Fax: 1(800) 737-7018

National Semiconductor Europe
 Fax: (+49) 0-180-530 85 86
 Email: cnjwge@tevm2.nsc.com
 Deutsch Tel: (+49) 0-180-530 85 85
 English Tel: (+49) 0-180-532 78 32
 Français Tel: (+49) 0-180-532 93 58
 Italiano Tel: (+49) 0-180-534 16 80

National Semiconductor Hong Kong Ltd.
 19th Floor, Straight Block,
 Ocean Centre, 5 Canton Rd.
 Tsimshatsui, Kowloon
 Hong Kong
 Tel: (852) 2737-1600
 Fax: (852) 2736-9960

National Semiconductor Japan Ltd.
 Tel: 81-043-299-2309
 Fax: 81-043-299-2408

National does not assume any responsibility for use of any circuitry described, no circuit patent licenses are implied and National reserves the right at any time without notice to change said circuitry and specifications.

IMPORTANT NOTICE

Texas Instruments Incorporated and its subsidiaries (TI) reserve the right to make corrections, modifications, enhancements, improvements, and other changes to its products and services at any time and to discontinue any product or service without notice. Customers should obtain the latest relevant information before placing orders and should verify that such information is current and complete. All products are sold subject to TI's terms and conditions of sale supplied at the time of order acknowledgment.

TI warrants performance of its hardware products to the specifications applicable at the time of sale in accordance with TI's standard warranty. Testing and other quality control techniques are used to the extent TI deems necessary to support this warranty. Except where mandated by government requirements, testing of all parameters of each product is not necessarily performed.

TI assumes no liability for applications assistance or customer product design. Customers are responsible for their products and applications using TI components. To minimize the risks associated with customer products and applications, customers should provide adequate design and operating safeguards.

TI does not warrant or represent that any license, either express or implied, is granted under any TI patent right, copyright, mask work right, or other TI intellectual property right relating to any combination, machine, or process in which TI products or services are used. Information published by TI regarding third-party products or services does not constitute a license from TI to use such products or services or a warranty or endorsement thereof. Use of such information may require a license from a third party under the patents or other intellectual property of the third party, or a license from TI under the patents or other intellectual property of TI.

Reproduction of TI information in TI data books or data sheets is permissible only if reproduction is without alteration and is accompanied by all associated warranties, conditions, limitations, and notices. Reproduction of this information with alteration is an unfair and deceptive business practice. TI is not responsible or liable for such altered documentation. Information of third parties may be subject to additional restrictions.

Resale of TI products or services with statements different from or beyond the parameters stated by TI for that product or service voids all express and any implied warranties for the associated TI product or service and is an unfair and deceptive business practice. TI is not responsible or liable for any such statements.

TI products are not authorized for use in safety-critical applications (such as life support) where a failure of the TI product would reasonably be expected to cause severe personal injury or death, unless officers of the parties have executed an agreement specifically governing such use. Buyers represent that they have all necessary expertise in the safety and regulatory ramifications of their applications, and acknowledge and agree that they are solely responsible for all legal, regulatory and safety-related requirements concerning their products and any use of TI products in such safety-critical applications, notwithstanding any applications-related information or support that may be provided by TI. Further, Buyers must fully indemnify TI and its representatives against any damages arising out of the use of TI products in such safety-critical applications.

TI products are neither designed nor intended for use in military/aerospace applications or environments unless the TI products are specifically designated by TI as military-grade or "enhanced plastic." Only products designated by TI as military-grade meet military specifications. Buyers acknowledge and agree that any such use of TI products which TI has not designated as military-grade is solely at the Buyer's risk, and that they are solely responsible for compliance with all legal and regulatory requirements in connection with such use.

TI products are neither designed nor intended for use in automotive applications or environments unless the specific TI products are designated by TI as compliant with ISO/TS 16949 requirements. Buyers acknowledge and agree that, if they use any non-designated products in automotive applications, TI will not be responsible for any failure to meet such requirements.

Following are URLs where you can obtain information on other Texas Instruments products and application solutions:

Products

Audio	www.ti.com/audio
Amplifiers	amplifier.ti.com
Data Converters	dataconverter.ti.com
DLP® Products	www.dlp.com
DSP	dsp.ti.com
Clocks and Timers	www.ti.com/clocks
Interface	interface.ti.com
Logic	logic.ti.com
Power Mgmt	power.ti.com
Microcontrollers	microcontroller.ti.com
RFID	www.ti-rfid.com
OMAP Mobile Processors	www.ti.com/omap
Wireless Connectivity	www.ti.com/wirelessconnectivity

Applications

Communications and Telecom	www.ti.com/communications
Computers and Peripherals	www.ti.com/computers
Consumer Electronics	www.ti.com/consumer-apps
Energy and Lighting	www.ti.com/energy
Industrial	www.ti.com/industrial
Medical	www.ti.com/medical
Security	www.ti.com/security
Space, Avionics and Defense	www.ti.com/space-avionics-defense
Transportation and Automotive	www.ti.com/automotive
Video and Imaging	www.ti.com/video

TI E2E Community Home Page

e2e.ti.com

Mailing Address: Texas Instruments, Post Office Box 655303, Dallas, Texas 75265
Copyright © 2011, Texas Instruments Incorporated







Looking for pricing, stock, or lifecycle information?

Click below to explore more details on WIN SOURCE:

 [View LMX2216M](#) on WIN SOURCE

 [Texas Instruments](#) Information

Optimize Your Supply Chain with WIN SOURCE Solutions

-  Global Sourcing Solution
-  Obsolete Management
-  Cost Control Management
-  Shortage Management
-  Alternative Solution
-  Excess Inventory Management