



SANYO Semiconductors

# DATA SHEET

## STK681-210-E — Thick-Film Hybrid IC Forward/Reverse Motor Driver

### Overview

The STK681-210-E is a hybrid IC for use in current control forward/reverse DC motor driver with brush.

### Applications

- Office photocopiers, printers, etc.

### Features

- Allows forward, reverse, and brake operations in accordance with the external input signal.
- 5.2A startup output current and 8A peak brake output current.
- Incorporating a current detection resistor (0.08Ω), fixed current control is possible.  
Can drive a bipolar stepping motor by using the two drivers.

### Specifications

**Absolute maximum ratings** at  $T_c = 25^\circ\text{C}$

Parameter	Symbol	Conditions	Ratings	unit
Maximum supply voltage 1	$V_{CC1 \text{ max}}$	$V_{CC2}=0\text{V}$	52	V
Maximum supply voltage 2	$V_{CC2 \text{ max}}$	No signal	-0.3 to +7.0	V
Input voltage	$V_{IN \text{ max}}$	Logic input pins	-0.3 to +7.0	V
Output current	$I_O \text{ max}$	$V_{CC2}=5.0\text{V}$ , DC current	5.2	A
Brake current	$I_{OB \text{ max}}$	$V_{CC2}=5.0\text{V}$ , square wave current, operating time 60ms (single pulse)	8	A
Operating substrate temperature	$T_c \text{ max}$		105	$^\circ\text{C}$
Junction temperature	$T_j \text{ max}$		150	$^\circ\text{C}$
Storage temperature	$T_{stg}$		-40 to +125	$^\circ\text{C}$

■ Any and all SANYO Semiconductor Co.,Ltd. products described or contained herein are, with regard to "standard application", intended for the use as general electronics equipment (home appliances, AV equipment, communication device, office equipment, industrial equipment etc.). The products mentioned herein shall not be intended for use for any "special application" (medical equipment whose purpose is to sustain life, aerospace instrument, nuclear control device, burning appliances, transportation machine, traffic signal system, safety equipment etc.) that shall require extremely high level of reliability and can directly threaten human lives in case of failure or malfunction of the product or may cause harm to human bodies, nor shall they grant any guarantee thereof. If you should intend to use our products for applications outside the standard applications of our customer who is considering such use and/or outside the scope of our intended standard applications, please consult with us prior to the intended use. If there is no consultation or inquiry before the intended use, our customer shall be solely responsible for the use.

■ Specifications of any and all SANYO Semiconductor Co.,Ltd. products described or contained herein stipulate the performance, characteristics, and functions of the described products in the independent state, and are not guarantees of the performance, characteristics, and functions of the described products as mounted in the customer's products or equipment. To verify symptoms and states that cannot be evaluated in an independent device, the customer should always evaluate and test devices mounted in the customer's products or equipment.

**SANYO Semiconductor Co., Ltd.**

TOKYO OFFICE Tokyo Bldg., 1-10, 1 Chome, Ueno, Taito-ku, TOKYO, 110-8534 JAPAN

# STK681-210-E

## Allowable Operating Ranges at $T_a=25^\circ\text{C}$

Parameter	Symbol	Conditions	Ratings	unit
Operating supply voltage 1	$V_{CC1}$	With signals applied	10 to 42	V
Operating supply voltage 2	$V_{CC2}$	With signals applied	$5\pm 5\%$	V
Input voltage	$V_{IN}$		0 to $V_{CC2}$	V
Output current 1	$I_{O1}$	$V_{CC2}=5.0\text{V}$ , DC current, $T_c\leq 70^\circ\text{C}$	5.2	A
Output current 2	$I_{O2}$	$V_{CC2}=5.0\text{V}$ , DC current, $T_c=90^\circ\text{C}$	4.2	A
Output current 3	$I_{O3}$	$V_{CC2}=5.0\text{V}$ , DC current, $T_c=105^\circ\text{C}$	3.5	A
Brake current	$I_{OB}$	$V_{CC2}=5.0\text{V}$ , square wave current, operating time 3.6ms, $T_c=105^\circ\text{C}$	8	A

Refer to the graph for each conduction-period tolerance range for the output current and brake current.

## Electrical Characteristics at $T_c=25^\circ\text{C}$ , $V_{CC1}=24\text{V}$ , $V_{CC2}=5.0\text{V}$

Parameter	Symbol	Conditions	min	typ	max	unit
$V_{CC2}$ supply current	$I_{CCO}$	Forward or reverse operation		3.2	8	mA
FET diode forward voltage	$V_{df}$	$I_f=1\text{A}$ ( $R_L=23\Omega$ )		0.85	1.6	V
Output saturation voltage 1	$V_{sat1}$	$R_L=23\Omega$ , F1, F2		0.15	0.22	V
Output saturation voltage 2	$V_{sat2}$	$R_L=23\Omega$ , F3, F4+current detection resistance		0.20	0.28	V
Output leak current	$I_{OL}$	F1, F2, F3, and F4 OFF operation			50	$\mu\text{A}$
Input high voltage	$V_{IH}$	IN1, IN2, INH pins	3.5			V
Input low voltage	$V_{IL}$	IN1, IN2, INH pins			0.6	V
Input current	$I_{IH}$	IN1, IN2, INH pins, $V_{IH}=5\text{V}$	0.10	0.20	0.40	mA
Current setting voltage	$V_{ref1}$	Between pins $V_{ref1}$ and S.P		0.42		V

Note: A fixed-voltage power supply must be used.

## Package Dimensions

unit:mm (typ)

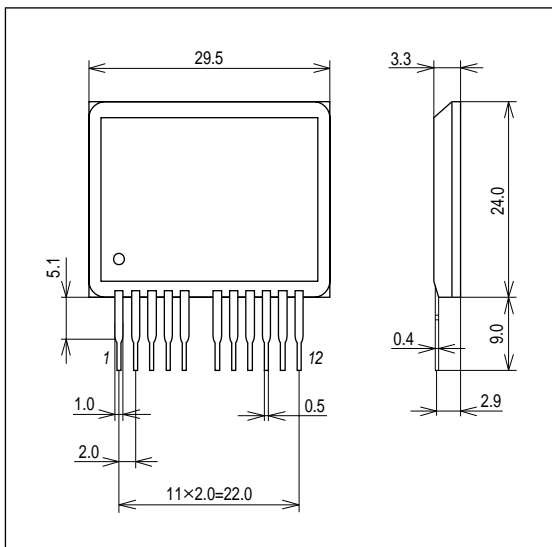

# STK681-210-E

Derating Curve of Motor Current,  $I_O$ , vs. STK681-210-E Operating Board Temperature,  $T_c$

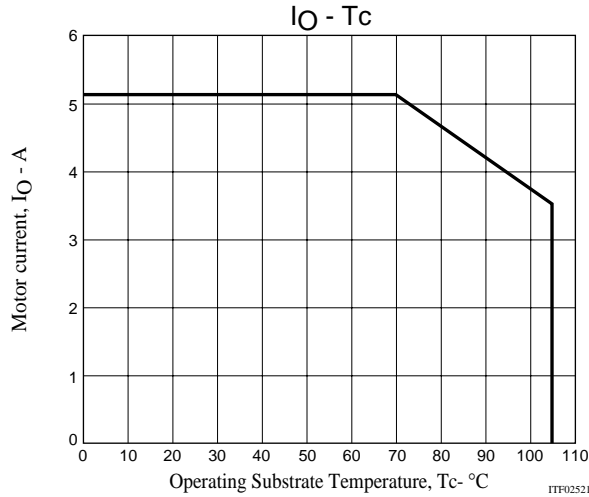

The motor current,  $I_O$ , shown above represents the range of DC operation and chopping operation.

The above graph shows performance when the overheating current control function (when pin 10 is connected to GND) is inoperational. For  $I_O$  characteristics when overheating current control is operational, see  $I_O$ - $T_c$  characteristics given in the Technical Information.

Since  $T_c$  fluctuates due to the ambient temperature,  $T_a$ , the motor current value, and continuous or intermittent operations of the motor current, always confirm this values using an actual set.

STK681-210-E Allowable Brake Current Range

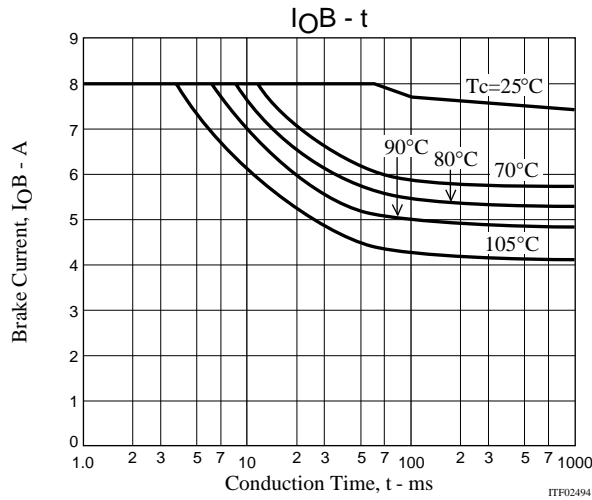

# STK681-210-E

## Block Diagram

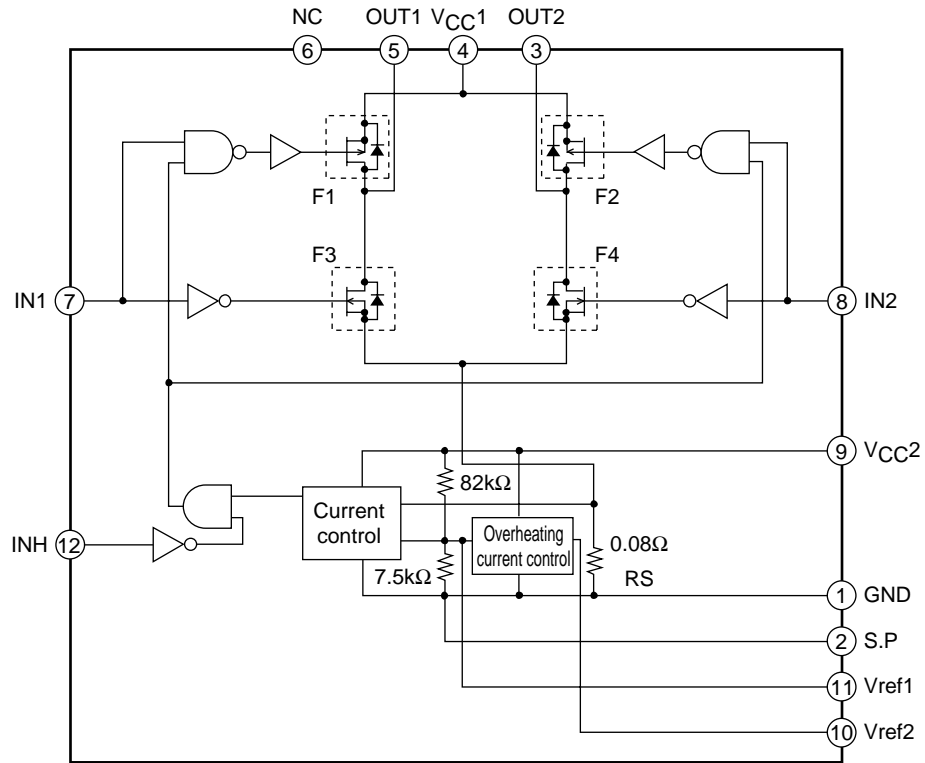

ITF02475

## Sample Application Circuit

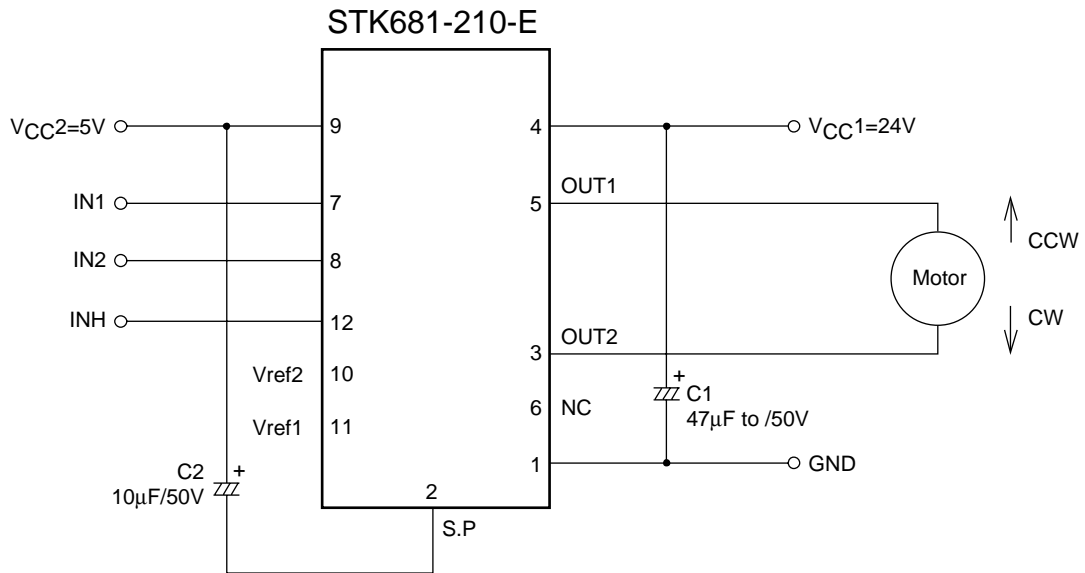

ITF02474

# STK681-210-E

## Motor Drive Conditions (H: High-level input; L: Low-Level Input)

	IN1	IN2	INH	Remarks
Stop 1 (standby)	H	H	H or L	When motor is not rotating
Stop 2 (supply power turned off by input during motor rotation)	H	H	H	Stop signal applied during motor rotation
	H	L	H	
	L	H	H	
Forward (CW)	H	L	L	No input signal is needed that turns off the upper- and lower-side drive devices when switching the rotational direction.
Reverse (CCW)	L	H	L	
Brake	L	L	L	GND side MOSFET ON

\* IN1=IN2=H and INH=L are prohibited during motor rotation.

### Notes

- (1) Be sure to set the capacitance of the power supply bypass capacitor, C1, so that the ripple current of the capacitor, which varies as motor current increases, falls within the allowed range.
- (2) Although the Vref 2 pin is kept open, if connected to the GND or S.P pin, the overheating current control circuit ceases to function.
- (3) Fixed current chopping operations based on F1 and F2 are used for current control. The timing given below is used for OUT1 or OUT2 voltage output and for F1 or F2 collector current.

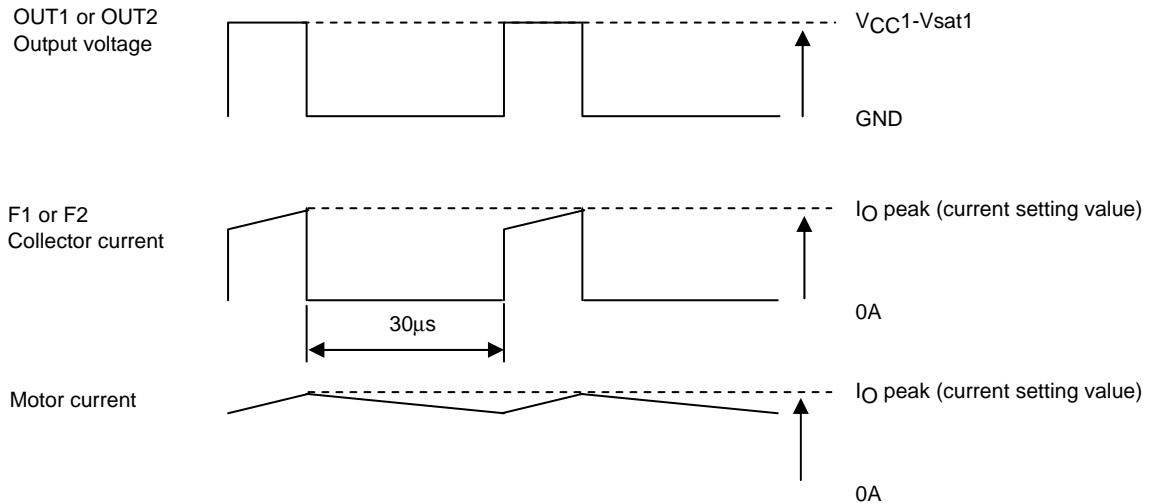

# STK681-210-E

## (4) Sample Timing Diagram

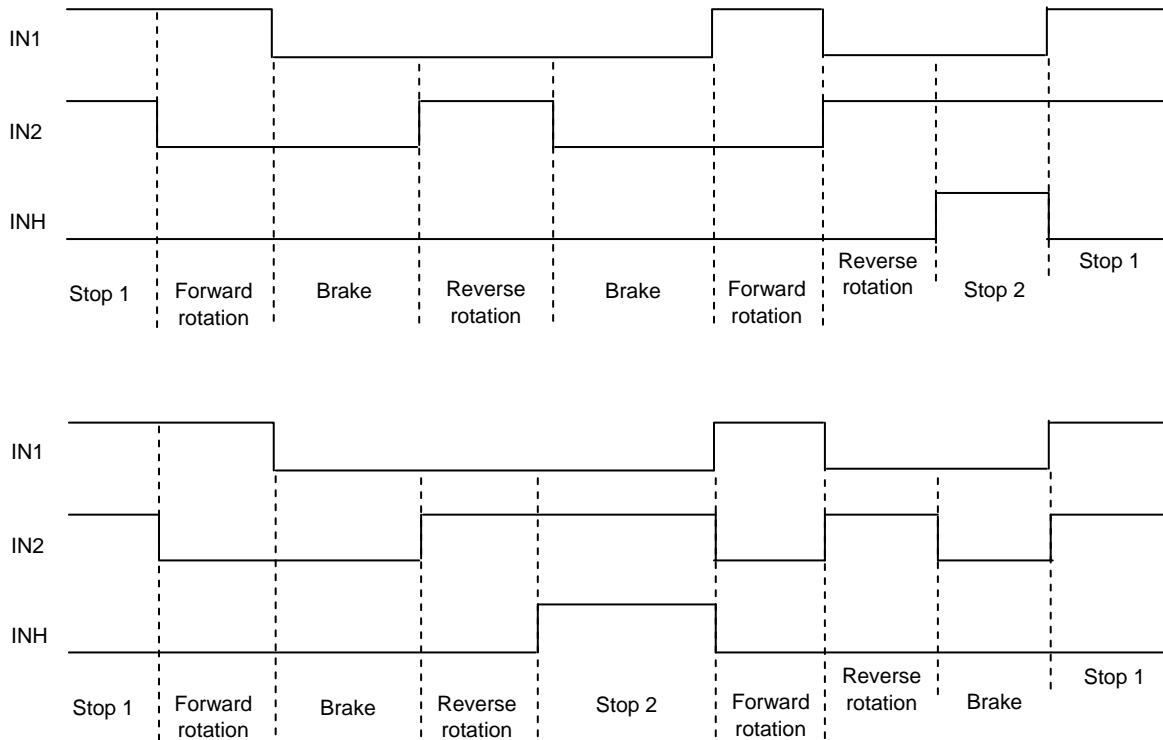

## I/O Functions of Each Pin

Pin Name	Pin No.	Function
IN1	7	Input pin for turning F1 and F3 ON and OFF At high level, F1: ON and F3: OFF; at low level F1: OFF and F3: ON
IN2	8	Input pin for turning F2 and F4 ON and OFF At high level, F2: ON and F4: OFF; at low level, F2: OFF and F4: ON
INH	12	Pin for turning F1 and F2 OFF; At high level F1 and F2: OFF This pin is usually low or open.
OUT1	5	This pin connects to the motor and outputs source/sync current depending on conditions at IN1 and IN2.
OUT2	3	This pin connects to the motor and outputs source/sync current depending on conditions at IN1 and IN2.
Vref1	11	A voltage of 0.42V at Tc=25°C results for the current set voltage used in fixed current operations. A voltage of 0.42V at Tc=25°C results for Vref1. 0.42V is set by connecting 82kΩ and 7.5kΩ in series. Current detection resistance is Rs=0.08Ω. Set using $I_O \text{ peak} = V_{\text{ref1}} \div R_s$ .
Vref2	10	Be sure to usually leave this pin open. The overheating control circuit can be made to stop operating by connecting this pin to the GND or S.P pin.
S.P	2	Vref1 voltage can be lowered by connecting a resistor between the Vref1 and S.P pins.

Technical Information

(1) Substrate temperature rise,  $\Delta T_c$  (no heat sink) - Internal average power dissipation, PdAV

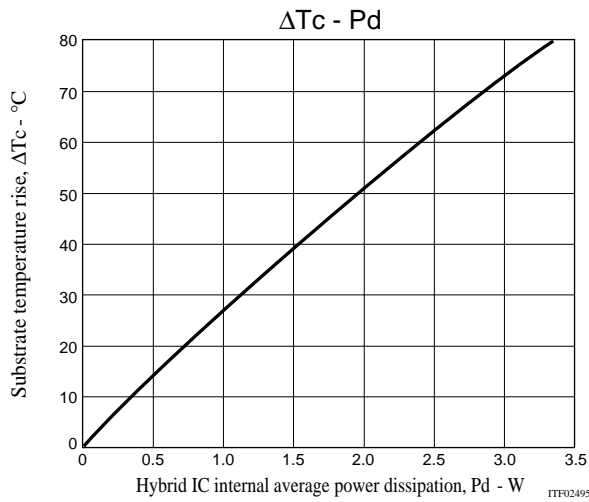

(2) Internal average power dissipation, Pd, in the DC current-motor current, I<sub>O</sub>, characteristics (typ values for Pd)

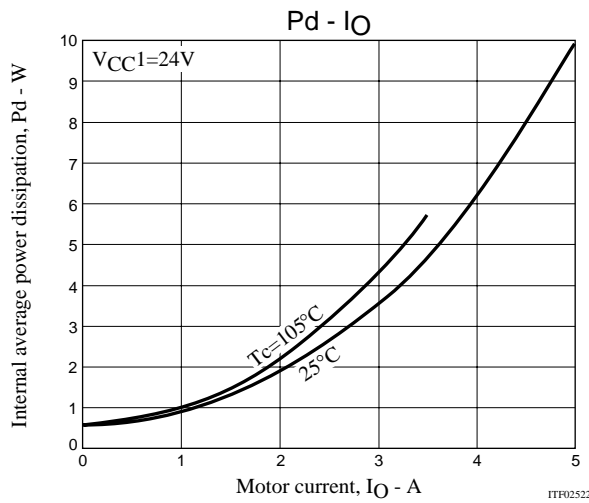

(3) Overheating current control characteristics

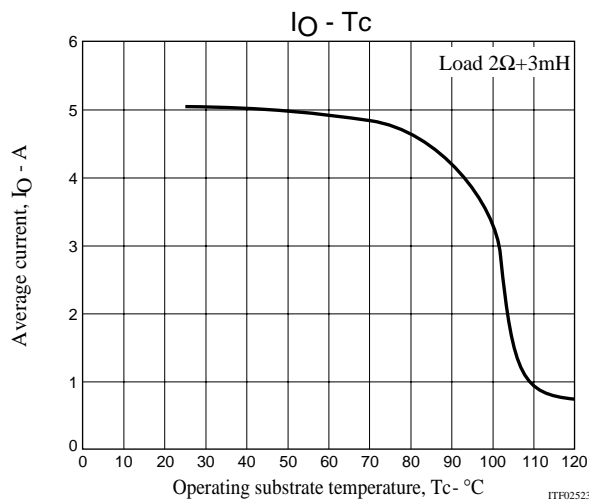

Overheating current control functions to prevent driver failure if a motor lock malfunction occurs.

# STK681-210-E

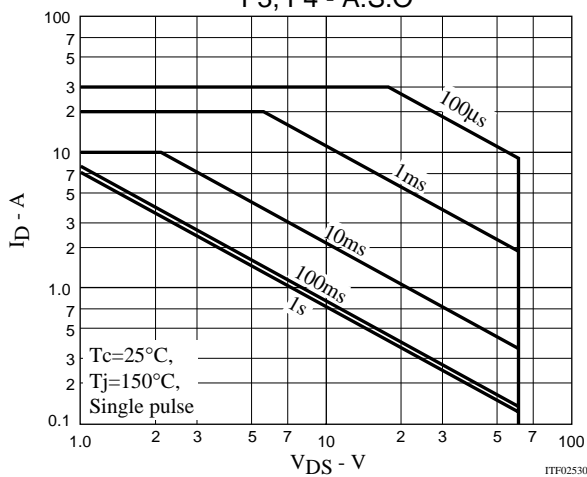
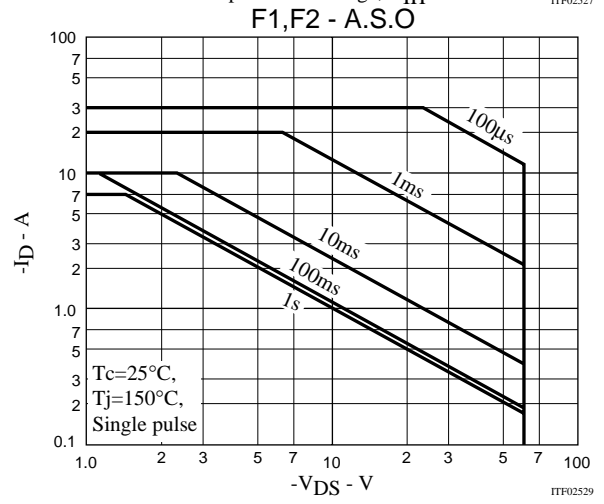
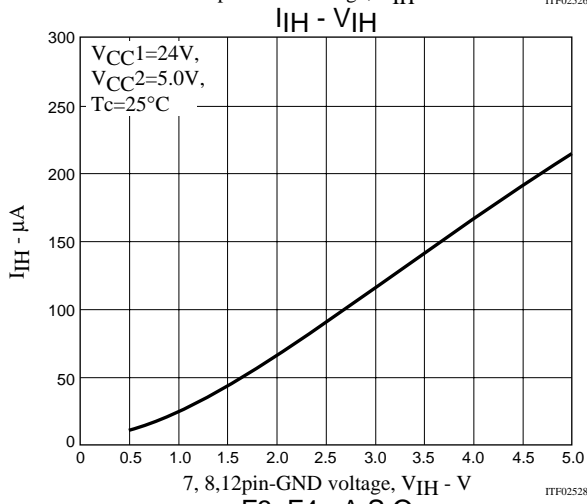
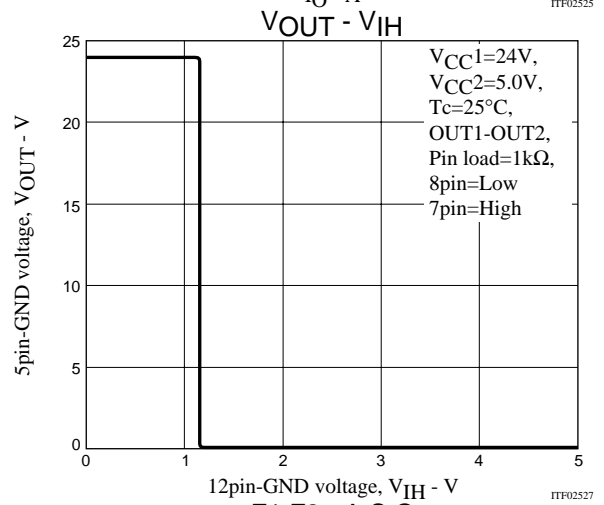
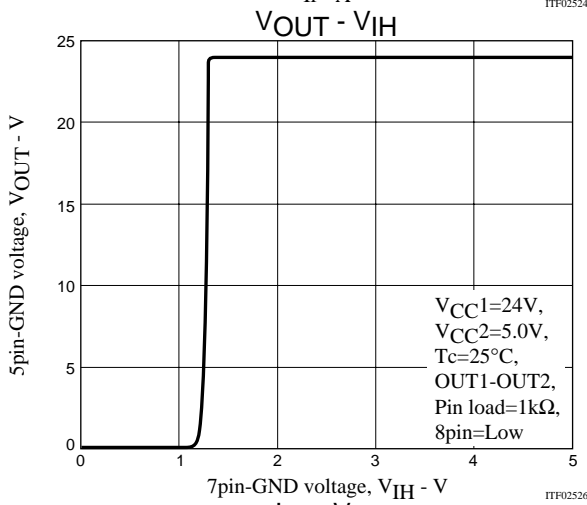
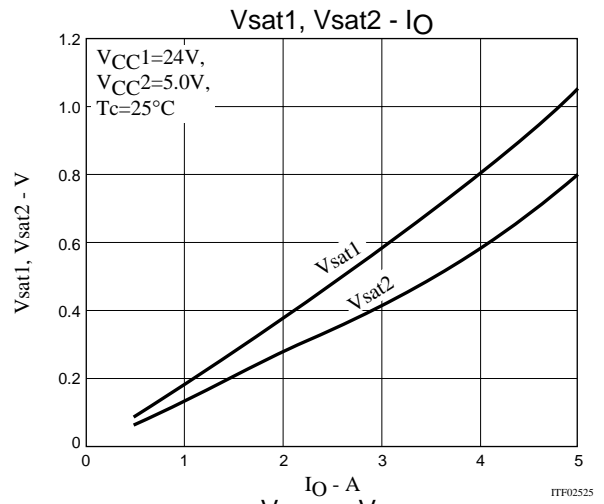
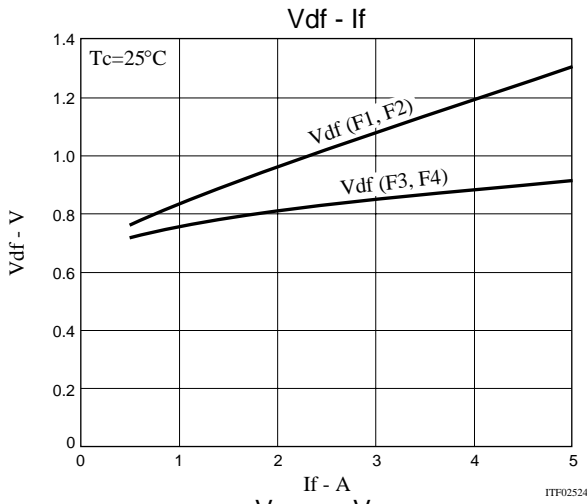

Input Pin Configurations

IN1, IN2

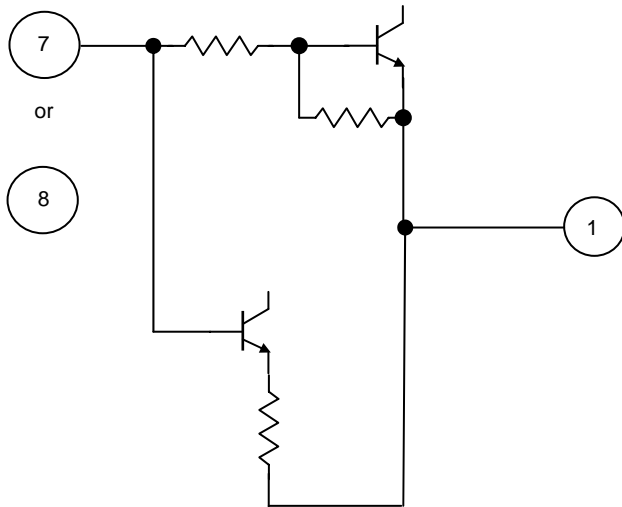

INH

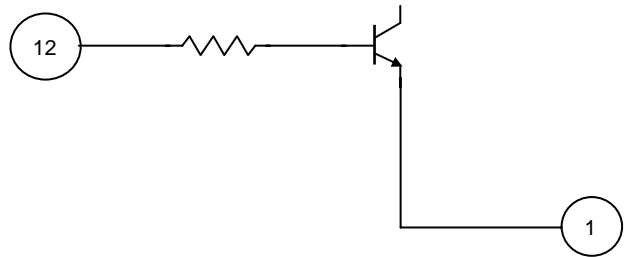

■ SANYO Semiconductor Co.,Ltd. assumes no responsibility for equipment failures that result from using products at values that exceed, even momentarily, rated values (such as maximum ratings, operating condition ranges, or other parameters) listed in products specifications of any and all SANYO Semiconductor Co.,Ltd. products described or contained herein.

■ SANYO Semiconductor Co.,Ltd. strives to supply high-quality high-reliability products, however, any and all semiconductor products fail or malfunction with some probability. It is possible that these probabilistic failures or malfunction could give rise to accidents or events that could endanger human lives, trouble that could give rise to smoke or fire, or accidents that could cause damage to other property. When designing equipment, adopt safety measures so that these kinds of accidents or events cannot occur. Such measures include but are not limited to protective circuits and error prevention circuits for safe design, redundant design, and structural design.

■ In the event that any or all SANYO Semiconductor Co.,Ltd. products described or contained herein are controlled under any of applicable local export control laws and regulations, such products may require the export license from the authorities concerned in accordance with the above law.

■ No part of this publication may be reproduced or transmitted in any form or by any means, electronic or mechanical, including photocopying and recording, or any information storage or retrieval system, or otherwise, without the prior written consent of SANYO Semiconductor Co.,Ltd.

■ Any and all information described or contained herein are subject to change without notice due to product/technology improvement, etc. When designing equipment, refer to the "Delivery Specification" for the SANYO Semiconductor Co.,Ltd. product that you intend to use.



■ Information (including circuit diagrams and circuit parameters) herein is for example only; it is not guaranteed for volume production.

■ Upon using the technical information or products described herein, neither warranty nor license shall be granted with regard to intellectual property rights or any other rights of SANYO Semiconductor Co.,Ltd. or any third party. SANYO Semiconductor Co.,Ltd. shall not be liable for any claim or suits with regard to a third party's intellectual property rights which has resulted from the use of the technical information and products mentioned above.

This catalog provides information as of July, 2008. Specifications and information herein are subject to change without notice.

## Looking for pricing, stock, or lifecycle information?

Click below to explore more details on WIN SOURCE:

-  [View STK681-210-E on WIN SOURCE](#)
-  [ON Semiconductor](#) Information

## Optimize Your Supply Chain with WIN SOURCE Solutions

-  Global Sourcing Solution
-  Obsolete Management
-  Cost Control Management
-  Shortage Management
-  Alternative Solution
-  Excess Inventory Management