



**THE DATASHEET OF  
MC3488AP1G**



# MC3488A

## Dual EIA-423/EIA-232D Line Driver

The MC3488A dual is single-ended line driver has been designed to satisfy the requirements of EIA standards EIA-423 and EIA-232D, as well as CCITT X.26, X.28 and Federal Standard FIDS1030. It is suitable for use where signal wave shaping is desired and the output load resistance is greater than 450 Ω. Output slew rates are adjustable from 1.0 μs to 100 μs by a single external resistor. Output level and slew rate are insensitive to power supply variations. Input undershoot diodes limit transients below ground and output current limiting is provided in both output states.

The MC3488A has a standard 1.5 V input logic threshold for TTL or NMOS compatibility.

### Features

- PNP Buffered Inputs to Minimize Input Loading
- Short Circuit Protection
- Adjustable Slew Rate Limiting
- MC3488A Equivalent to 9636A
- Output Levels and Slew Rates are Insensitive to Power Supply Voltages
- No External Blocking Diode Required for V<sub>EE</sub> Supply
- Second Source μA9636A
- Pb-Free Packages are Available



ON Semiconductor®

<http://onsemi.com>

### MARKING DIAGRAMS



SOIC-8  
D SUFFIX  
CASE 751

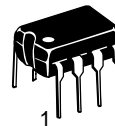
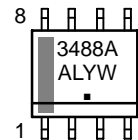

PDIP-8  
P1 SUFFIX  
CASE 626

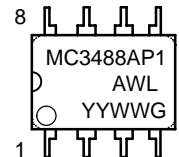

A = Assembly Location  
L, WL = Wafer Lot  
Y, YY = Year  
W, WW = Work Week  
▪ or G = Pb-Free Package  
(Note: Microdot may be in either location)

### PIN CONNECTIONS

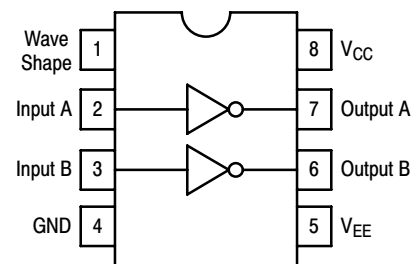

### ORDERING INFORMATION

See detailed ordering and shipping information in the package dimensions section on page 3 of this data sheet.

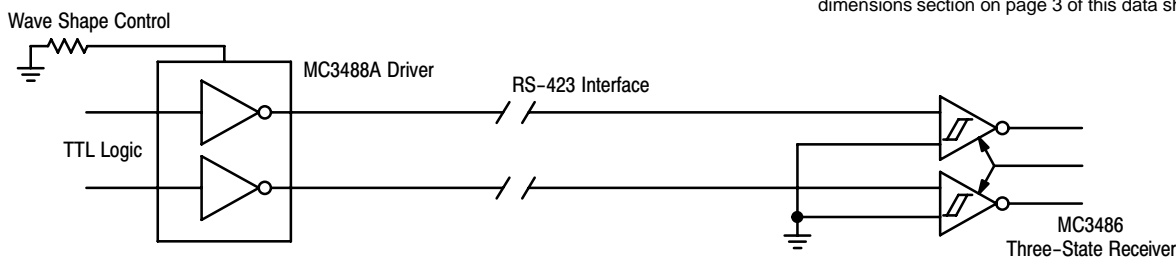

Figure 1. Simplified Application

# MC3488A

## MAXIMUM RATINGS (Note 1)

Rating	Symbol	Value	Unit
Power Supply Voltages	$V_{CC}$ $V_{EE}$	+ 15 – 15	V
Output Current	Source Sink $I_{O+}$ $I_{O-}$	+ 150 – 150	mA
Operating Ambient Temperature	$T_A$	0 to + 70	°C
Junction Temperature Range	$T_J$	150	°C
Storage Temperature Range	$T_{stg}$	– 65 to + 150	°C

Stresses exceeding Maximum Ratings may damage the device. Maximum Ratings are stress ratings only. Functional operation above the Recommended Operating Conditions is not implied. Extended exposure to stresses above the Recommended Operating Conditions may affect device reliability.

1. Devices should not be operated at these values. The "Electrical Characteristics" provide conditions for actual device operation.

## RECOMMENDED OPERATING CONDITIONS

Characteristic	Symbol	Min	Typ	Max	Unit
Power Supply Voltages	$V_{CC}$ $V_{EE}$	10.8 – 13.2	12 – 12	13.2 – 10.8	V
Operating Temperature Range	$T_A$	0	25	70	°C
Wave Shaping Resistor	$R_{WS}$	10	–	1000	k $\Omega$

## TARGET ELECTRICAL CHARACTERISTICS (Unless otherwise noted, specifications apply over recommended operating conditions)

Characteristic	Symbol	Min	Typ	Max	Unit
Input Voltage – Low Logic State	$V_{IL}$	–	–	0.8	V
Input Voltage – High Logic State	$V_{IH}$	2.0	–	–	V
Input Current – Low Logic State ( $V_{IL} = 0.4$ V)	$I_{IL}$	– 80	–	–	$\mu$ A
Input Current – High Logic State ( $V_{IH} = 2.4$ V) ( $V_{IH} = 5.5$ V)	$I_{IH1}$ $I_{IH2}$	– –	– –	10 100	$\mu$ A
Input Clamp Diode Voltage ( $I_{IK} = -15$ mA)	$V_{IK}$	– 1.5	–	–	V
Output Voltage – Low Logic State ( $R_L = \infty$ ), EIA–423 ( $R_L = 3.0$ k $\Omega$ ), EIA–232D ( $R_L = 450$ $\Omega$ ), EIA–423	$V_{OL}$	– 6.0 – 6.0 – 6.0	– – –	– 5.0 – 5.0 – 4.0	V
Output Voltage – High Logic State ( $R_L = \infty$ ), EIA–423 ( $R_L = 3.0$ k $\Omega$ ), EIA–232D ( $R_L = 450$ $\Omega$ ), EIA–423	$V_{OH}$	5.0 5.0 4.0	– – –	6.0 6.0 6.0	V
Output Resistance ( $R_L \geq 450$ $\Omega$ )	$R_O$	–	25	50	$\Omega$
Output Short–Circuit Current (Note 2) ( $V_{in} = V_{out} = 0$ V) ( $V_{in} = V_{IH(Min)}$ , $V_{out} = 0$ V)	$I_{OSH}$ $I_{OSL}$	– 150 + 15	– –	– 15 + 150	mA
Output Leakage Current (Note 3) ( $V_{CC} = V_{EE} = 0$ V, $-6.0$ V $\leq V_o \leq 6.0$ V)	$I_{ox}$	– 100	–	100	$\mu$ A
Power Supply Currents ( $R_W = 100$ k $\Omega$ , $R_L = \infty$ , $V_{IL} \leq V_{in} \leq V_{IH}$ )	$I_{CC}$ $I_{EE}$	– – 18	– –	+ 18 –	mA

2. One output shorted at a time.  
3. No  $V_{EE}$  diode required.

# MC3488A

**TRANSITION TIMES** (Unless otherwise noted,  $C_L = 30 \text{ pF}$ ,  $f = 1.0 \text{ kHz}$ ,  $V_{CC} = -V_{EE} = 12.0 \text{ V} \pm 10\%$ ,  $T_A = 25^\circ\text{C}$ ,  $R_L = 450 \Omega$ . Transition times measured 10% to 90% and 90% to 10%)

Characteristic	Symbol	Min	Typ	Max	Unit
Transition Time, Low-to-High State Output ( $R_W = 10 \text{ k}\Omega$ ) ( $R_W = 100 \text{ k}\Omega$ ) ( $R_W = 500 \text{ k}\Omega$ ) ( $R_W = 1000 \text{ k}\Omega$ )	$t_{TLH}$	0.8 8.0 40 80		1.4 14 70 140	$\mu\text{s}$
Transition Time, High-to-Low State Output ( $R_W = 10 \text{ k}\Omega$ ) ( $R_W = 100 \text{ k}\Omega$ ) ( $R_W = 500 \text{ k}\Omega$ ) ( $R_W = 1000 \text{ k}\Omega$ )	$t_{THL}$	0.8 8.0 40 80		1.4 14 70 140	$\mu\text{s}$

## ORDERING INFORMATION

Device	Operating Temperature Range	Package	Shipping†
MC3488AD	$T_A = 0 \text{ to } +70^\circ\text{C}$	SOIC-8	98 Units / Rail
MC3488ADG		SOIC-8 (Pb-Free)	98 Units / Rail
MC3488ADR2		SOIC-8	1000 / Tape & Reel
MC3488ADR2G		SOIC-8 (Pb-Free)	1000 / Tape & Reel
MC3488AP1		PDIP-8	50 Units / Rail
MC3488AP1G		PDIP-8 (Pb-Free)	50 Units / Rail

†For information on tape and reel specifications, including part orientation and tape sizes, please refer to our Tape and Reel Packaging Specifications Brochure, BRD8011/D.

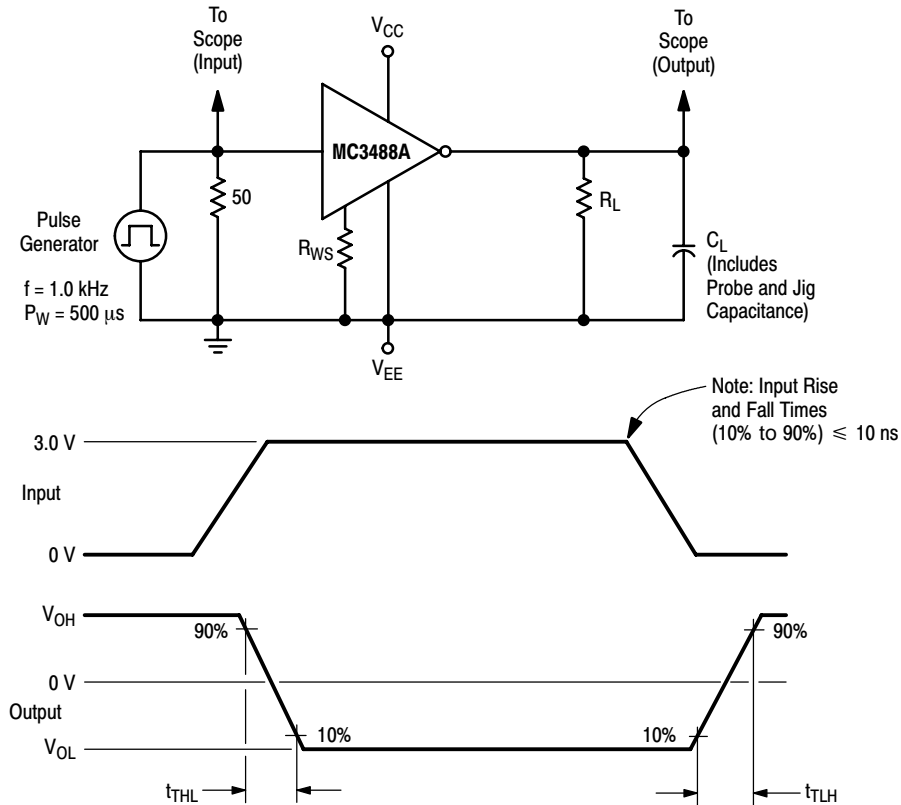
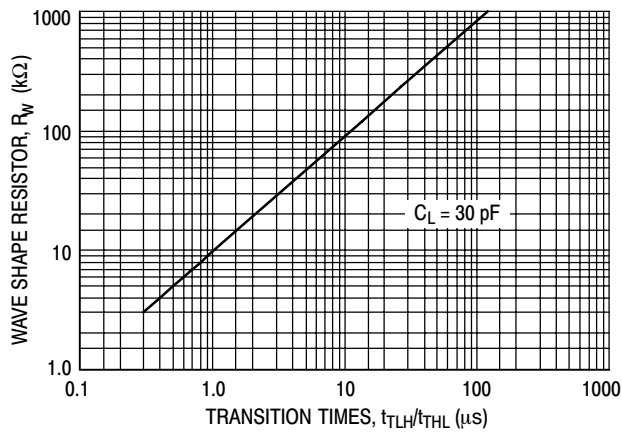
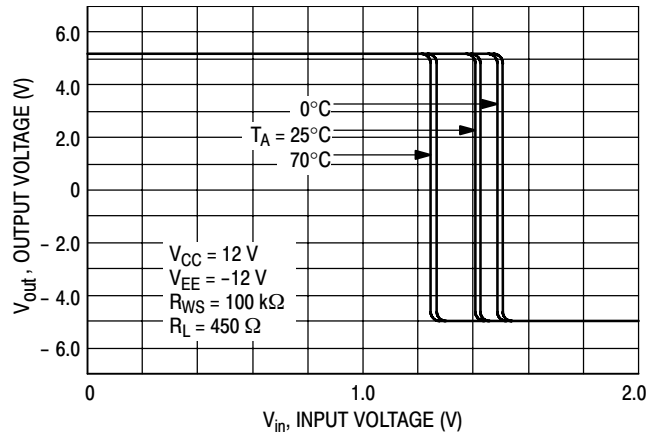

Figure 2. Test Circuit and Waveforms for Transition Times

# MC3488A



**Figure 3. Output Transition Times versus Wave Shape Resistor Value**



**Figure 4. Input/Output Characteristics versus Temperature**

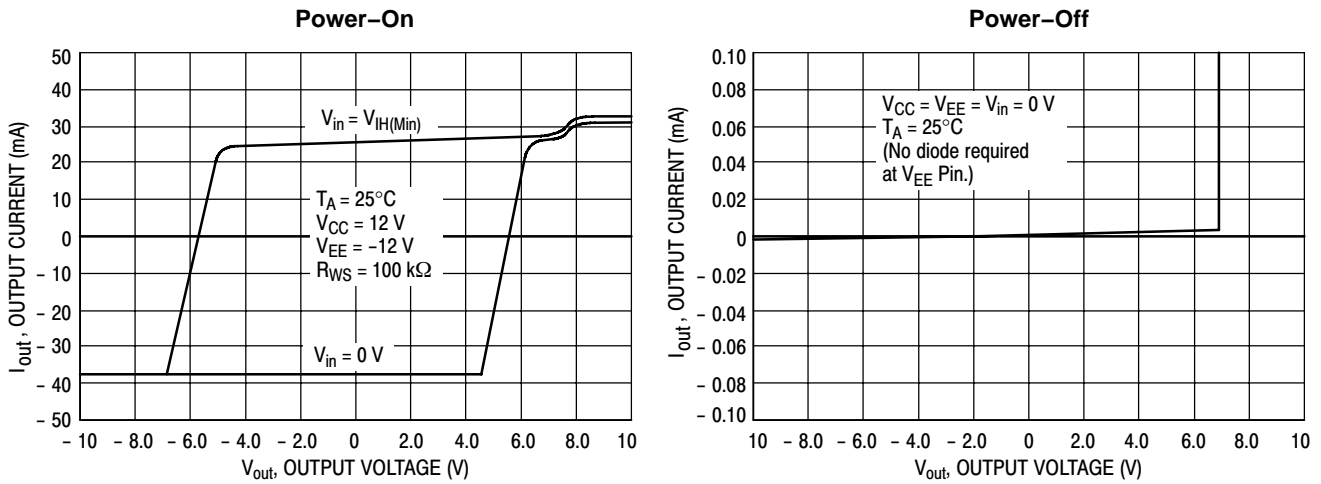

**Figure 5. Output Current versus Output Voltage**

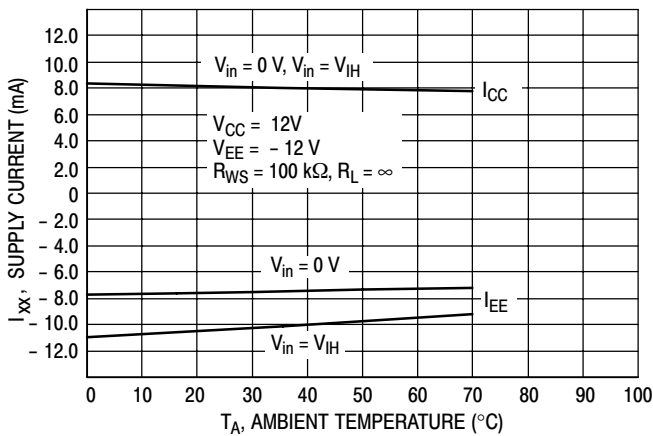

**Figure 6. Supply Current versus Temperature**

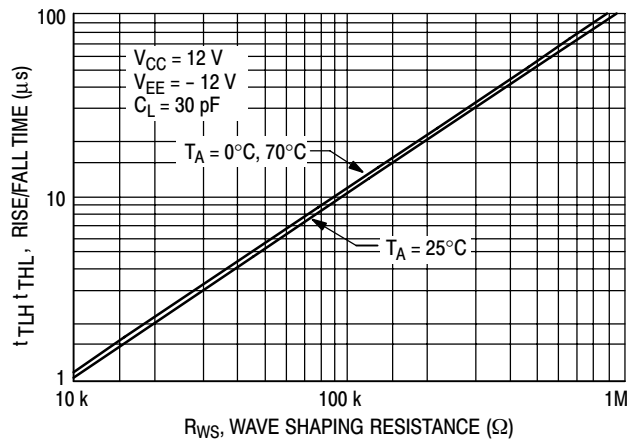
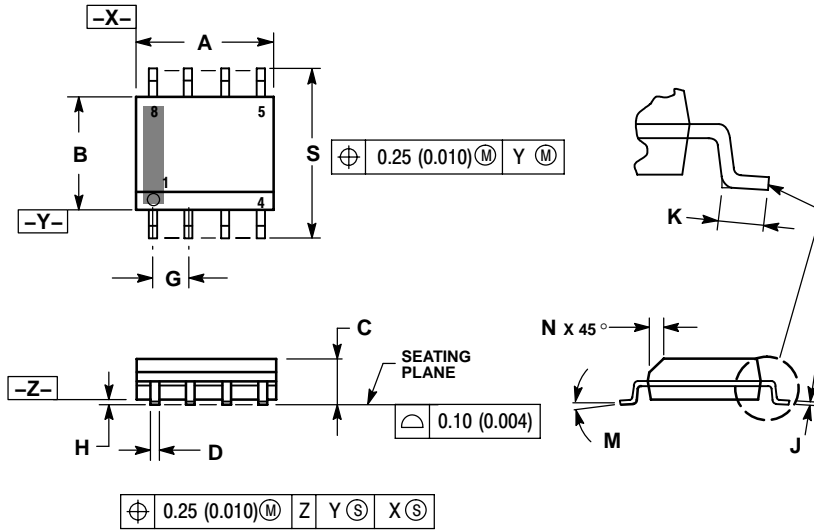

**Figure 7. Rise/Fall Time versus R\_ws**

# MC3488A

## PACKAGE DIMENSIONS

SOIC-8 NB  
D SUFFIX  
PLASTIC PACKAGE  
CASE 751-07  
ISSUE AH



**NOTES:**

1. DIMENSIONING AND TOLERANCING PER ANSI Y14.5M, 1982.
2. CONTROLLING DIMENSION: MILLIMETER.
3. DIMENSION A AND B DO NOT INCLUDE MOLD PROTRUSION.
4. MAXIMUM MOLD PROTRUSION 0.15 (0.006) PER SIDE.
5. DIMENSION D DOES NOT INCLUDE DAMBAR PROTRUSION. ALLOWABLE DAMBAR PROTRUSION SHALL BE 0.127 (0.005) TOTAL IN EXCESS OF THE D DIMENSION AT MAXIMUM MATERIAL CONDITION.
6. 751-01 THRU 751-06 ARE OBSOLETE. NEW STANDARD IS 751-07.

DIM	MILLIMETERS		INCHES	
	MIN	MAX	MIN	MAX
A	4.80	5.00	0.189	0.197
B	3.80	4.00	0.150	0.157
C	1.35	1.75	0.053	0.069
D	0.33	0.51	0.013	0.020
G	1.27 BSC		0.050 BSC	
H	0.10	0.25	0.004	0.010
J	0.19	0.25	0.007	0.010
K	0.40	1.27	0.016	0.050
M	0°	8°	0°	8°
N	0.25	0.50	0.010	0.020
S	5.80	6.20	0.228	0.244

### SOLDERING FOOTPRINT\*

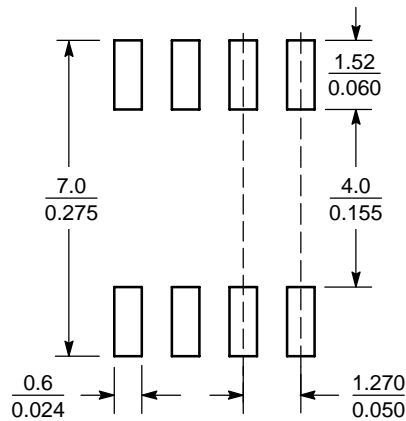

SCALE 6:1 (mm/inches)

\*For additional information on our Pb-Free strategy and soldering details, please download the ON Semiconductor Soldering and Mounting Techniques Reference Manual, SOLDERRM/D.

# MC3488A

## PACKAGE DIMENSIONS

PDIP-8  
P1 SUFFIX  
PLASTIC PACKAGE  
CASE 626-05  
ISSUE L

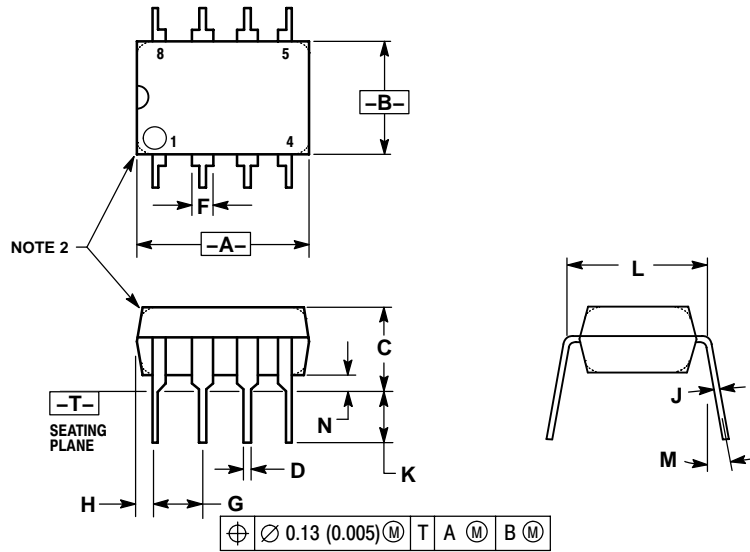

NOTES:

1. DIMENSION L TO CENTER OF LEAD WHEN FORMED PARALLEL.
2. PACKAGE CONTOUR OPTIONAL (ROUND OR SQUARE CORNERS).
3. DIMENSIONING AND TOLERANCING PER ANSI Y14.5M, 1982.

DIM	MILLIMETERS		INCHES	
	MIN	MAX	MIN	MAX
A	9.40	10.16	0.370	0.400
B	6.10	6.60	0.240	0.260
C	3.94	4.45	0.155	0.175
D	0.38	0.51	0.015	0.020
F	1.02	1.78	0.040	0.070
G	2.54 BSC		0.100 BSC	
H	0.76	1.27	0.030	0.050
J	0.20	0.30	0.008	0.012
K	2.92	3.43	0.115	0.135
L	7.62 BSC		0.300 BSC	
M	---	10°	---	10°
N	0.76	1.01	0.030	0.040

ON Semiconductor and are registered trademarks of Semiconductor Components Industries, LLC (SCILLC). SCILLC reserves the right to make changes without further notice to any products herein. SCILLC makes no warranty, representation or guarantee regarding the suitability of its products for any particular purpose, nor does SCILLC assume any liability arising out of the application or use of any product or circuit, and specifically disclaims any and all liability, including without limitation special, consequential or incidental damages. "Typical" parameters which may be provided in SCILLC data sheets and/or specifications can and do vary in different applications and actual performance may vary over time. All operating parameters, including "Typicals" must be validated for each customer application by customer's technical experts. SCILLC does not convey any license under its patent rights nor the rights of others. SCILLC products are not designed, intended, or authorized for use as components in systems intended for surgical implant into the body, or other applications intended to support or sustain life, or for any other application in which the failure of the SCILLC product could create a situation where personal injury or death may occur. Should Buyer purchase or use SCILLC products for any such unintended or unauthorized application, Buyer shall indemnify and hold SCILLC and its officers, employees, subsidiaries, affiliates, and distributors harmless against all claims, costs, damages, and expenses, and reasonable attorney fees arising out of, directly or indirectly, any claim of personal injury or death associated with such unintended or unauthorized use, even if such claim alleges that SCILLC was negligent regarding the design or manufacture of the part. SCILLC is an Equal Opportunity/Affirmative Action Employer. This literature is subject to all applicable copyright laws and is not for resale in any manner.

### PUBLICATION ORDERING INFORMATION

**LITERATURE FULFILLMENT:**  
Literature Distribution Center for ON Semiconductor  
P.O. Box 5163, Denver, Colorado 80217 USA  
**Phone:** 303-675-2175 or 800-344-3860 Toll Free USA/Canada  
**Fax:** 303-675-2176 or 800-344-3867 Toll Free USA/Canada  
**Email:** orderlit@onsemi.com

**N. American Technical Support:** 800-282-9855 Toll Free  
USA/Canada  
**Europe, Middle East and Africa Technical Support:**  
Phone: 421 33 790 2910  
**Japan Customer Focus Center**  
Phone: 81-3-5773-3850

**ON Semiconductor Website:** [www.onsemi.com](http://www.onsemi.com)  
**Order Literature:** <http://www.onsemi.com/orderlit>  
For additional information, please contact your local Sales Representative

## Looking for pricing, stock, or lifecycle information?

Click below to explore more details on WIN SOURCE:

 [View MC3488AP1G](#) on WIN SOURCE

 [ON Semiconductor](#) Information

## Optimize Your Supply Chain with WIN SOURCE Solutions

-  Global Sourcing Solution
-  Obsolete Management
-  Cost Control Management
-  Shortage Management
-  Alternative Solution
-  Excess Inventory Management