



**THE DATASHEET OF  
MAX6425UK22+T**



## MAX6340/MAX6421– MAX6426

## Low-Power, SC70/SOT $\mu$ P Reset Circuits with Capacitor-Adjustable Reset Timeout Delay

### General Description

The MAX6340/MAX6421–MAX6426 low-power microprocessor supervisor circuits monitor system voltages from 1.6V to 5V. These devices perform a single function: they assert a reset signal whenever the  $V_{CC}$  supply voltage falls below its reset threshold. The reset output remains asserted for the reset timeout period after  $V_{CC}$  rises above the reset threshold. The reset timeout is externally set by a capacitor to provide more flexibility.

The MAX6421/MAX6424 have an active-low, push-pull reset output. The MAX6422 has an active-high, push-pull reset output and the MAX6340/MAX6423/ MAX6425/ MAX6426 have an active-low, open-drain reset output. The MAX6421/MAX6422/MAX6423 are offered in 4-pin SC70 or SOT143 packages. The MAX6340/MAX6424/ MAX6425/MAX6426 are available in 5-pin SOT23-5 packages.

### Applications

- Portable Equipment
- Battery-Powered Computers/Controllers
- Automotive
- Medical Equipment
- Intelligent Instruments
- Embedded Controllers
- Critical  $\mu$ P Monitoring
- Set-Top Boxes
- Computers

### Pin Configurations



### Benefits and Features

- Monitor System Voltages from 1.6V to 5V
- Capacitor-Adjustable Reset Timeout Period
- Low Quiescent Current (1.6 $\mu$ A typ)
- Three RESET Output Options
  - Push-Pull  $\overline{\text{RESET}}$
  - Push-Pull  $\text{RESET}$
  - Open-Drain  $\overline{\text{RESET}}$
- Guaranteed Reset Valid to  $V_{CC} = 1V$
- Immune to Short  $V_{CC}$  Transients
- Small 4-Pin SC70, 4-Pin SOT143, and 5-Pin SOT23 Packages
- MAX6340 Pin Compatible with LP3470
- MAX6424/MAX6425 Pin Compatible with NCP300–NCP303, MC33464/MC33465, S807/S808/S809, and RN5VD
- MAX6426 Pin Compatible with PST92XX
- AEC-Q100 Qualified (MAX6340UK31/V+T)

*Typical Operating Circuit, Selector Guide, and Ordering Information appear at end of data sheet.*

# MAX6340/MAX6421– MAX6426

# Low-Power, SC70/SOT $\mu$ P Reset Circuits with Capacitor-Adjustable Reset Timeout Delay

## Absolute Maximum Ratings

All Voltages Referenced to GND

$V_{CC}$ .....	-0.3V to +6.0V
SRT, $\overline{\text{RESET}}$ , RESET (push-pull).....	-0.3V to ( $V_{CC} + 0.3$ V)
RESET (open drain).....	-0.3V to +6.0V
Input Current (all pins).....	$\pm 20$ mA
Output Current ( $\overline{\text{RESET}}$ , RESET).....	$\pm 20$ mA

Continuous Power Dissipation ( $T_A = +70^\circ\text{C}$ )

4-Pin SC70 (derate 3.1mW/ $^\circ\text{C}$ above $+70^\circ\text{C}$ ).....	245mW
4-Pin SOT143 (derate 4mW/ $^\circ\text{C}$ above $+70^\circ\text{C}$ ) .....	320mW
5-Pin SOT23 (derate 7.1mW/ $^\circ\text{C}$ above $+70^\circ\text{C}$ ) .....	571mW
Operating Temperature Range.....	$-40^\circ\text{C}$ to $+125^\circ\text{C}$
Storage Temperature Range.....	$-65^\circ\text{C}$ to $+150^\circ\text{C}$
Junction Temperature.....	$+150^\circ\text{C}$
Lead Temperature (soldering, 10s) .....	$+300^\circ\text{C}$

Stresses beyond those listed under "Absolute Maximum Ratings" may cause permanent damage to the device. These are stress ratings only, and functional operation of the device at these or any other conditions beyond those indicated in the operational sections of the specifications is not implied. Exposure to absolute maximum rating conditions for extended periods may affect device reliability.

## Electrical Characteristics

( $V_{CC} = 1\text{V}$  to  $5.5\text{V}$ ,  $T_A = T_{\text{MIN}}$  to  $T_{\text{MAX}}$ , unless otherwise specified. Typical values are at  $V_{CC} = 5\text{V}$  and  $T_A = +25^\circ\text{C}$ .) (Note 1)

PARAMETER	SYMBOL	CONDITIONS	MIN	TYP	MAX	UNITS
Supply Voltage Range	$V_{CC}$		1.0		5.5	V
Supply Current	$I_{CC}$	$V_{CC} \leq 5.0\text{V}$		2.5	4.2	$\mu\text{A}$
		$V_{CC} \leq 3.3\text{V}$		1.9	3.4	
		$V_{CC} \leq 2.0\text{V}$		1.6	2.5	
$V_{CC}$ Reset Threshold Accuracy	$V_{TH}$	$T_A = +25^\circ\text{C}$	$V_{TH} - 1.5\%$		$V_{TH} + 1.5\%$	V
		$T_A = -40^\circ\text{C}$ to $+125^\circ\text{C}$	$V_{TH} - 2.5\%$		$V_{TH} + 2.5\%$	
Hysteresis	$V_{HYST}$			$4 \times V_{TH}$		mV
$V_{CC}$ to Reset Delay	$t_{RD}$	$V_{CC}$ falling at $1\text{mV}/\mu\text{s}$		80		$\mu\text{s}$
Reset Timeout Period	$t_{RP}$	$C_{SRT} = 1500\text{pF}$	3.00	4.375	5.75	ms
		$C_{SRT} = 0$		0.275		
$V_{SRT}$ Ramp Current	$I_{RAMP}$	$V_{SRT} = 0$ to $0.65\text{V}$ ; $V_{CC} = 1.6\text{V}$ to $5\text{V}$		240		nA
$V_{SRT}$ Ramp Threshold	$V_{TH-RAMP}$	$V_{CC} = 1.6\text{V}$ to $5\text{V}$ ( $V_{RAMP}$ rising)		0.65		V
RAMP Threshold Hysteresis		$V_{RAMP}$ falling threshold		33		mV
$\overline{\text{RESET}}$ Output Voltage Low	$V_{OL}$	$V_{CC} \geq 1.0\text{V}$ , $I_{SINK} = 50\mu\text{A}$			0.3	V
		$V_{CC} \geq 2.7\text{V}$ , $I_{SINK} = 1.2\text{mA}$			0.3	
		$V_{CC} \geq 4.5\text{V}$ , $I_{SINK} = 3.2\text{mA}$			0.4	
$\overline{\text{RESET}}$ Output Voltage High, Push-Pull	$V_{OH}$	$V_{CC} \geq 1.8\text{V}$ , $I_{SOURCE} = 200\mu\text{A}$	$0.8 \times V_{CC}$			V
		$V_{CC} \geq 2.25\text{V}$ , $I_{SOURCE} = 500\mu\text{A}$	$0.8 \times V_{CC}$			
		$V_{CC} \geq 4.5\text{V}$ , $I_{SOURCE} = 800\mu\text{A}$	$0.8 \times V_{CC}$			
RESET Output Leakage Current, Open-Drain	$I_{LKG}$	$V_{CC} > V_{TH}$ , reset not asserted			1.0	$\mu\text{A}$
RESET Output Voltage High	$V_{OH}$	$V_{CC} \geq 1.0\text{V}$ , $I_{SOURCE} = 1\mu\text{A}$	$0.8 \times V_{CC}$			V
		$V_{CC} \geq 1.8\text{V}$ , $I_{SOURCE} = 150\mu\text{A}$	$0.8 \times V_{CC}$			
		$V_{CC} \geq 2.7\text{V}$ , $I_{SOURCE} = 500\mu\text{A}$	$0.8 \times V_{CC}$			
		$V_{CC} \geq 4.5\text{V}$ , $I_{SOURCE} = 800\mu\text{A}$	$0.8 \times V_{CC}$			
RESET Output Voltage Low	$V_{OL}$	$V_{CC} \geq 1.8\text{V}$ , $I_{SINK} = 500\mu\text{A}$			0.3	V
		$V_{CC} \geq 2.7\text{V}$ , $I_{SINK} = 1.2\text{mA}$			0.3	
		$V_{CC} \geq 4.5\text{V}$ , $I_{SINK} = 3.2\text{mA}$			0.4	

**Note 1:** Devices production tested at  $+25^\circ\text{C}$ . Overtemperature limits are guaranteed by design.

Typical Operating Characteristics

( $V_{CC} = 5V$ ,  $C_{SRT} = 1500pF$ ,  $T_A = +25^\circ C$ , unless otherwise noted.)

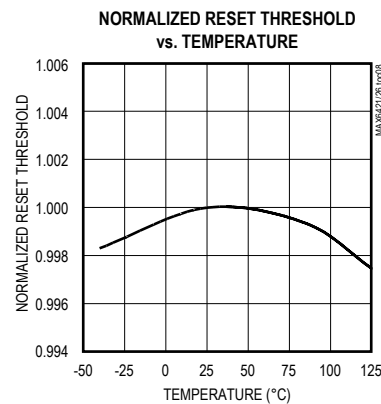
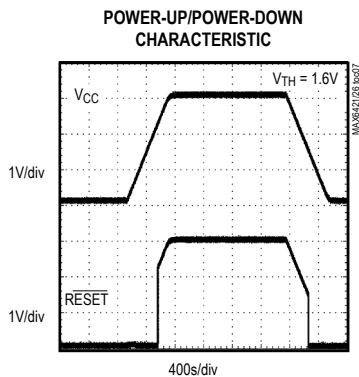
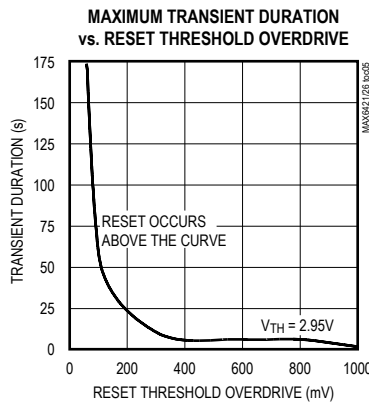
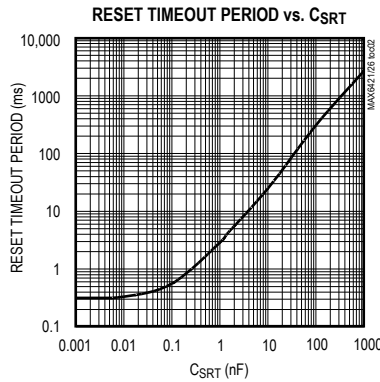

## Pin Description

PIN					NAME	FUNCTION
MAX6340	MAX6421 MAX6422 MAX6423	MAX6424 MAX6425	MAX6426			
SOT23	SOT143	SC70	SOT23	SOT23		
1	3	3	5	1	SRT	Set Reset Timeout Input. Connect a capacitor between SRT and ground to set the timeout period. Determine the period as follows: $t_{RP} = 2.73 \times 10^6 \times C_{SRT} + 275\mu s$ with $t_{RP}$ in seconds and $C_{SRT}$ in farads
2	1	2	3	2, 3	GND	Ground
3	—	—	4	—	N.C.	Not Internally Connected. Can be connected to GND
4	2	1	2	5	V <sub>CC</sub>	Supply Voltage and Reset Threshold Monitor Input
5	4	4	1	4	$\overline{\text{RESET}}$	$\overline{\text{RESET}}$ changes from high to low whenever V <sub>CC</sub> drops below the selected reset threshold voltage. $\overline{\text{RESET}}$ remains low for the reset timeout period after V <sub>CC</sub> exceeds the reset threshold
—			—	—	—	RESET

## Detailed Description

### Reset Output

The reset output is typically connected to the reset input of a  $\mu$ P. A  $\mu$ P's reset input starts or restarts the  $\mu$ P in a known state. The MAX6340/MAX6421–MAX6426  $\mu$ P supervisory circuits provide the reset logic to prevent code-execution errors during power-up, power-down, and brownout conditions (see *Typical Operating Characteristics*).

$\overline{\text{RESET}}$  changes from high to low whenever V<sub>CC</sub> drops below the threshold voltage. Once V<sub>CC</sub> exceeds the threshold voltage,  $\overline{\text{RESET}}$  remains low for the capacitor-adjustable reset timeout period.

The MAX6422 active-high RESET output is the inverse logic of the active-low  $\overline{\text{RESET}}$  output. All device outputs are guaranteed valid for V<sub>CC</sub> > 1V.

The MAX6340/MAX6423/MAX6425/MAX6426 are open-drain  $\overline{\text{RESET}}$  outputs. Connect an external pullup resistor to any supply from 0 to 5.5V. Select a resistor value large enough to register a logic low when  $\overline{\text{RESET}}$  is asserted and small enough to register a logic high while supplying all input current and leakage paths connected to the  $\overline{\text{RESET}}$  line. A 10k $\Omega$  to 100k $\Omega$  pullup is sufficient in most applications.

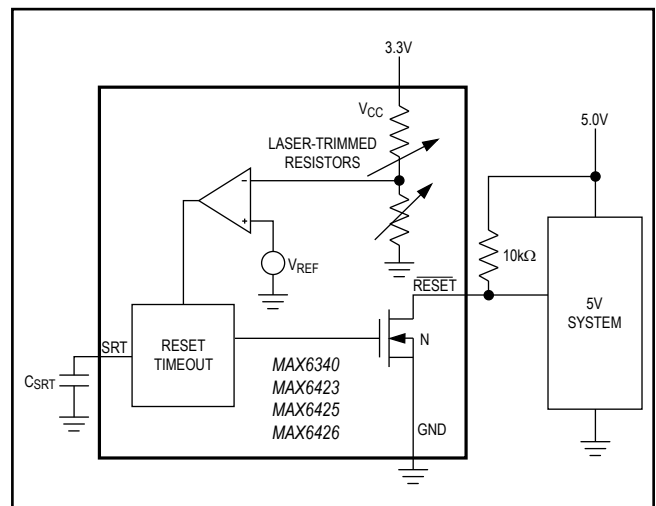

Figure 1. MAX6340/MAX6423/MAX6425/MAX6426 Open-Drain  $\overline{\text{RESET}}$  Output Allows Use with Multiple Supplies

### Selecting a Reset Capacitor

The reset timeout period is adjustable to accommodate a variety of  $\mu$ P applications. Adjust the reset timeout period ( $t_{RP}$ ) by connecting a capacitor ( $C_{SRT}$ ) between SRT and ground. Calculate the reset timeout capacitor as follows:

$$C_{SRT} = (t_{RP} - 275\mu s) / (2.73 \times 10^6)$$

where  $t_{RP}$  is in seconds and  $C_{SRT}$  is in farads.

The reset delay time is set by a current/capacitor-controlled ramp compared to an internal 0.65V reference. An internal 240nA ramp current source charges the external capacitor. The charge to the capacitor is cleared when a reset condition is detected. Once the reset condition is removed, the voltage on the capacitor ramps according to the formula:  $dV/dt = I/C$ . The  $C_{SRT}$  capacitor must ramp to 0.65V to deassert the reset.  $C_{SRT}$  must be a low-leakage (<10nA) type capacitor; ceramic is recommended.

### Operating as a Voltage Detector

The MAX6340/MAX6421–MAX6426 can be operated in a voltage detector mode by floating the SRT pin. The reset delay times for  $V_{CC}$  rising above or falling below the threshold are not significantly different. The reset output is deasserted smoothly without false pulses.



Figure 2. Wired-OR Reset Circuit

## Applications Information

### Interfacing to Other Voltages for Logic Compatibility

The open-drain outputs of the MAX6340/MAX6423/MAX6425/MAX6426 can be used to interface to  $\mu$ Ps with other logic levels. As shown in Figure 1, the open-drain output can be connected to voltages from 0 to 5.5V. This allows for easy logic compatibility to various  $\mu$ Ps.

### Wired-OR Reset

To allow auxiliary circuitry to hold the system in reset, an external open-drain logic signal can be connected to the open-drain  $\overline{\text{RESET}}$  of the MAX6340/MAX6423/MAX6425/MAX6426, as shown in Figure 2. This configuration can reset the  $\mu$ P, but does not provide the reset timeout when the external logic signal is released.

### Negative-Going $V_{CC}$ Transients

In addition to issuing a reset to the  $\mu$ P during power-up, power-down, and brownout conditions, these supervisors are relatively immune to short-duration negative-going transients (glitches). The graph Maximum Transient Duration vs. Reset Threshold Overdrive in the *Typical Operating Characteristics* shows this relationship.

The area below the curve of the graph is the region in which these devices typically do not generate a reset pulse. This graph was generated using a negative-going pulse applied to  $V_{CC}$ , starting above the actual reset threshold ( $V_{TH}$ ) and ending below it by the magnitude indicated (reset-threshold overdrive). As the magnitude of the transient decreases (farther below the reset threshold), the maximum allowable pulse width decreases. Typically, a  $V_{CC}$  transient that goes 100mV below the reset threshold and lasts 50 $\mu$ s or less does not cause a reset pulse to be issued.

### Ensuring a Valid $\overline{\text{RESET}}$ or $\overline{\text{RESET}}$ Down to $V_{CC} = 0$

When  $V_{CC}$  falls below 1V,  $\overline{\text{RESET}}$ / $\overline{\text{RESET}}$  current-sinking (sourcing) capabilities decline drastically. In the case of the MAX6421/MAX6424, high-impedance CMOS-logic inputs connected to  $\overline{\text{RESET}}$  can drift to undetermined voltages. This presents no problems in most applications, since most  $\mu$ Ps and other circuitry do not operate with  $V_{CC}$  below 1V.

In those applications where  $\overline{\text{RESET}}$  must be valid down to zero, adding a pulldown resistor between  $\overline{\text{RESET}}$  and ground sinks any stray leakage currents, holding  $\overline{\text{RESET}}$  low (Figure 3). The value of the pulldown resistor is not critical; 100k $\Omega$  is large enough not to load  $\overline{\text{RESET}}$  and small enough to pull  $\overline{\text{RESET}}$  to ground. For applications using the MAX6422, a 100k $\Omega$  pulldown resis-



Figure 3. Ensuring  $\overline{\text{RESET}}$  Valid to  $V_{CC} = 0$



Figure 4. Ensuring  $\overline{\text{RESET}}$  Valid to  $V_{CC} = 0$

tor between RESET and VCC holds RESET high when VCC falls below 1V (Figure 4). Open-drain RESET versions are not recommended for applications requiring valid logic for  $V_{CC}$  down to zero.

### Layout Consideration

SRT is a precise current source. When developing the layout for the application, be careful to minimize board capacitance and leakage currents around this pin. Traces connected to SRT should be kept as short as possible. Traces carrying high-speed digital signals and traces with large voltage potentials should be routed as far from SRT as possible. Leakage current and stray capacitance (e.g., a scope probe) at this pin could cause errors in the reset timeout period. When evaluating these parts, use clean prototype boards to ensure accurate reset periods.

Table 1. Reset Threshold Voltage Suffix

SUFFIX	MIN	TYP	MAX
16	1.536	1.575	1.614
17	1.623	1.665	1.707
18	1.755	1.800	1.845
19	1.853	1.900	1.948
20	1.950	2.000	2.050
21	2.048	2.100	2.153
22	2.133	2.188	2.243
23	2.255	2.313	2.371
24	2.340	2.400	2.460
25	2.438	2.500	2.563
26	2.559	2.625	2.691
27	2.633	2.700	2.768
28	2.730	2.800	2.870
29	2.852	2.925	2.998
30	2.925	3.000	3.075
31	2.998	3.075	3.152
32	3.120	3.200	3.280
33	3.218	3.300	3.383
34	3.315	3.400	3.485
35	3.413	3.500	3.558
36	3.510	3.600	3.690
37	3.608	3.700	3.793
38	3.705	3.800	3.895
39	3.803	3.900	3.998
40	3.900	4.000	4.100
41	3.998	4.100	4.203
42	4.095	4.200	4.305
43	4.193	4.300	4.408
44	4.266	4.375	4.484
45	4.388	4.500	4.613
46	4.509	4.625	4.741
47	4.583	4.700	4.818
48	4.680	4.800	4.920
49	4.778	4.900	5.023
50	4.875	5.000	5.125

Standard Versions Table

PART*	OUTPUT STAGE
MAX6340UK16+T	Open-Drain $\overline{\text{RESET}}$
MAX6340UK22+T	Open-Drain $\overline{\text{RESET}}$
MAX6340UK26+T	Open-Drain $\overline{\text{RESET}}$
MAX6340UK29+T	Open-Drain $\overline{\text{RESET}}$
MAX6340UK46+T	Open-Drain $\overline{\text{RESET}}$
MAX6421US16+T	Push-Pull $\overline{\text{RESET}}$
MAX6421XS16+T	Push-Pull $\overline{\text{RESET}}$
MAX6421US22+T	Push-Pull $\overline{\text{RESET}}$
MAX6421XS22+T	Push-Pull $\overline{\text{RESET}}$
MAX6421US26+T	Push-Pull $\overline{\text{RESET}}$
MAX6421XS26+T	Push-Pull $\overline{\text{RESET}}$
MAX6421US29+T	Push-Pull $\overline{\text{RESET}}$
MAX6421XS29+T	Push-Pull $\overline{\text{RESET}}$
MAX6421US46+T	Push-Pull $\overline{\text{RESET}}$
MAX6421XS46+T	Push-Pull $\overline{\text{RESET}}$
MAX6422US16+T	Push-Pull RESET
MAX6422XS16+T	Push-Pull RESET
MAX6422US22+T	Push-Pull RESET
MAX6422XS22+T	Push-Pull RESET
MAX6422US26+T	Push-Pull RESET
MAX6422XS26+T	Push-Pull RESET
MAX6422US29+T	Push-Pull RESET
MAX6422XS29+T	Push-Pull RESET
MAX6422US46+T	Push-Pull RESET
MAX6422XS46+T	Push-Pull RESET

PART*	OUTPUT STAGE
MAX6423US16+T	Open-Drain $\overline{\text{RESET}}$
MAX6423XS16+T	Open-Drain $\overline{\text{RESET}}$
MAX6423US22+T	Open-Drain $\overline{\text{RESET}}$
MAX6423XS22+T	Open-Drain $\overline{\text{RESET}}$
MAX6423US26+T	Open-Drain $\overline{\text{RESET}}$
MAX6423XS26+T	Open-Drain $\overline{\text{RESET}}$
MAX6423US29+T	Open-Drain $\overline{\text{RESET}}$
MAX6423XS29+T	Open-Drain $\overline{\text{RESET}}$
MAX6423US46+T	Open-Drain $\overline{\text{RESET}}$
MAX6423XS46+T	Open-Drain $\overline{\text{RESET}}$
MAX6424UK16+T	Push-Pull $\overline{\text{RESET}}$
MAX6424UK22+T	Push-Pull $\overline{\text{RESET}}$
MAX6424UK26+T	Push-Pull $\overline{\text{RESET}}$
MAX6424UK29+T	Push-Pull $\overline{\text{RESET}}$
MAX6424UK46+T	Push-Pull $\overline{\text{RESET}}$
MAX6425UK16+T	Open-Drain $\overline{\text{RESET}}$
MAX6425UK22+T	Open-Drain $\overline{\text{RESET}}$
MAX6425UK26+T	Open-Drain $\overline{\text{RESET}}$
MAX6425UK29+T	Open-Drain $\overline{\text{RESET}}$
MAX6425UK46+T	Open-Drain $\overline{\text{RESET}}$
MAX6426UK16+T	Open-Drain $\overline{\text{RESET}}$
MAX6426UK22+T	Open-Drain $\overline{\text{RESET}}$
MAX6426UK26+T	Open-Drain $\overline{\text{RESET}}$
MAX6426UK29+T	Open-Drain $\overline{\text{RESET}}$
MAX6426UK46+T	Open-Drain $\overline{\text{RESET}}$

Typical Operating Circuit



\*Sample stock is generally held on all standard versions. Contact factory for availability of nonstandard versions.

Pin Configurations (continued)

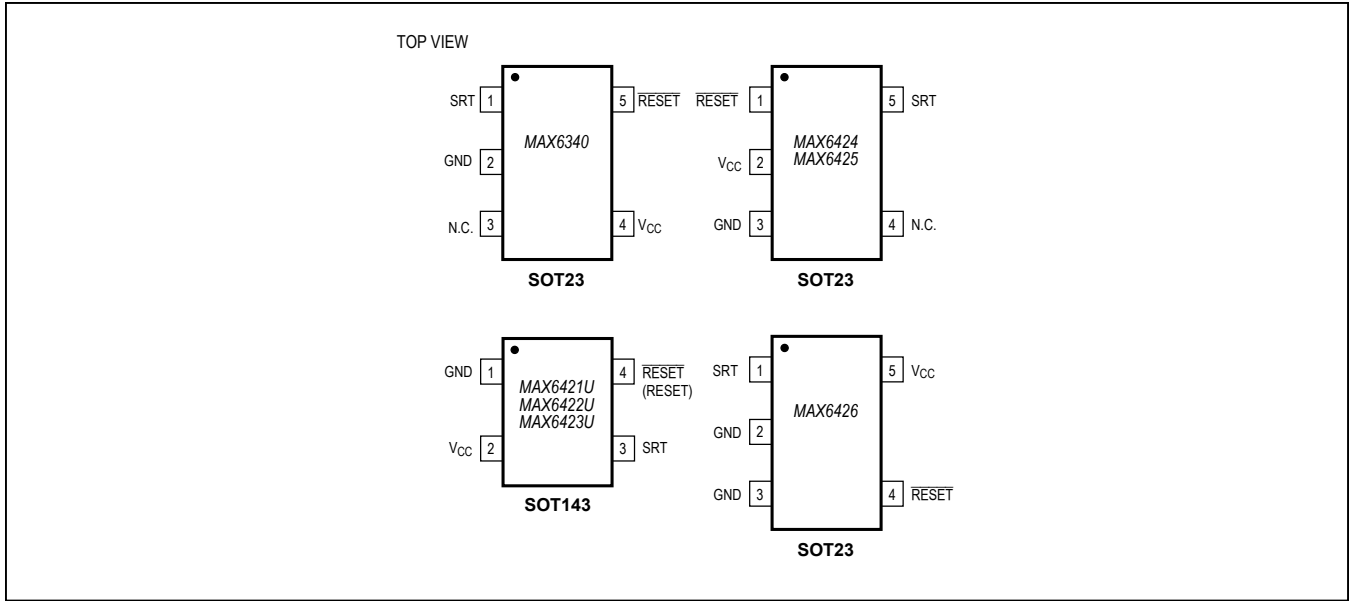

Selector Guide

PART	PUSH-PULL RESET	PUSH-PULL RESET	OPEN-DRAIN RESET	PIN-PACKAGE
MAX6340	—	—	✓	5 SOT23
MAX6421	✓	—	—	4 SOT143/SC70
MAX6422	—	✓	—	4 SOT143/SC70
MAX6423	—	—	✓	4 SOT143/SC70
MAX6424	✓	—	—	5 SOT23
MAX6425	—	—	✓	5 SOT23
MAX6426	—	—	✓	5 SOT23

## Ordering Information

PART	TEMP RANGE	PIN-PACKAGE
MAX6340UK__+T	-40°C to +125°C	5 SOT23-5
MAX6340UK__V+T	-40°C to +125°C	5 SOT23-5
MAX6340UK31V+T	-40°C to +125°C	5 SOT23-5
MAX6421XS__+T	-40°C to +125°C	4 SC70-4
MAX6421US__+T	-40°C to +125°C	4 SOT143-4
MAX6421US__-T	-40°C to +125°C	4 SOT143-4
MAX6422XS__+T	-40°C to +125°C	4 SC70-4
MAX6422US__+T	-40°C to +125°C	4 SOT143-4
MAX6422US__-T	-40°C to +125°C	4 SOT143-4
MAX6423XS__+T	-40°C to +125°C	4 SC70-4
MAX6423US__+T	-40°C to +125°C	4 SOT143-4
MAX6423US__-T	-40°C to +125°C	4 SOT143-4
MAX6424UK__+T	-40°C to +125°C	5 SOT23-5
MAX6424UK__-T	-40°C to +125°C	5 SOT23-5
MAX6425UK__+T	-40°C to +125°C	5 SOT23-5
MAX6425UK__-T	-40°C to +125°C	5 SOT23-5
MAX6426UK__+T	-40°C to +125°C	5 SOT23-5

**Note:** The MAX6340/MAX6421–MAX6426 are available with factory-trimmed reset thresholds from 1.575V to 5.0V in approximately 0.1V increments. Insert the desired nominal reset threshold suffix (from Table 1) into the blanks. There are 50 standard versions with a required order increment of 2500 pieces. Sample stock is generally held on standard versions only (see Standard Versions Table). Required order increment is 10,000 pieces for nonstandard versions. Contact factory for availability. All devices are available in tape-and-reel only.

Devices are available in both leaded and lead-free packaging. “+” Denotes Lead(Pb)-free packages and “-” denotes leaded packages.

For top mark information, please go to <https://www.maximintegrated.com/en/design/packaging/topmark/>

## Chip Information

TRANSISTOR COUNT: 295

PROCESS: BiCMOS

## Package Information

For the latest package outline information and land patterns (footprints), go to [www.maximintegrated.com/packages](http://www.maximintegrated.com/packages). Note that a “+”, “#”, or “-” in the package code indicates RoHS status only. Package drawings may show a different suffix character, but the drawing pertains to the package regardless of RoHS status.

PACKAGE TYPE	PACKAGE CODE	OUTLINE NO.	LAND PATTERN NO.
4 SC70	X4+1	<a href="#">21-0098</a>	<a href="#">90-0187</a>
4 SOT143	U4+1	<a href="#">21-0052</a>	<a href="#">90-0183</a>
5 SOT23	U5+2	<a href="#">21-0057</a>	<a href="#">90-0174</a>

## Revision History

REVISION NUMBER	REVISION DATE	DESCRIPTION	PAGES CHANGED
5	3/14	Added /V OPN to <i>Ordering Information</i>	1
6	12/15	Added lead-free part numbers to <i>Ordering Information</i> table and removed top mark information from <i>Standard Versions</i> table	1, 8
7	1/16	Changed MAX6340UK_ _/V-T to MAX6340UK_ _/V+T in <i>Ordering Information</i> table	9
8	9/16	Updated Table 1	6
9	3/18	Updated <i>Ordering Information</i> table	9
10	5/18	Updated <i>Benefits and Features</i> section	1

For pricing, delivery, and ordering information, please contact Maxim Direct at 1-888-629-4642, or visit Maxim Integrated's website at [www.maximintegrated.com](http://www.maximintegrated.com).

Maxim Integrated cannot assume responsibility for use of any circuitry other than circuitry entirely embodied in a Maxim Integrated product. No circuit patent licenses are implied. Maxim Integrated reserves the right to change the circuitry and specifications without notice at any time. The parametric values (min and max limits) shown in the *Electrical Characteristics* table are guaranteed. Other parametric values quoted in this data sheet are provided for guidance.

## Looking for pricing, stock, or lifecycle information?

Click below to explore more details on WIN SOURCE:

 [View MAX6425UK22+T on WIN SOURCE](#)

 [Maxim Integrated](#) Information

## Optimize Your Supply Chain with WIN SOURCE Solutions

-  Global Sourcing Solution
-  Obsolete Management
-  Cost Control Management
-  Shortage Management
-  Alternative Solution
-  Excess Inventory Management