



**THE DATASHEET OF
PE42442A-Z**



PE42442

UltraCMOS® SP4T RF Switch
30 MHz–6 GHz

Features

- Four symmetric, absorptive RF ports
- High isolation
 - 61 dB @ 900 MHz
 - 55 dB @ 2100 MHz
 - 52 dB @ 2700 MHz
 - 43 dB @ 4000 MHz
 - 32 dB @ 6000 MHz
- High linearity
 - IIP2 of 97 dBm
 - IIP3 of 58 dBm
- 1.8V control logic compatible
- 105 °C operating temperature
- Fast switching time of 255 ns
- Two- or three-pin CMOS logic control
- External negative supply option
- ESD performance
 - 4 kV HBM on RF pins to GND
 - 2 kV HBM on all pins

Product Description

The PE42442 is a HaRP™ technology-enhanced absorptive SP4T RF switch designed for use in 3G/4G wireless infrastructure and other high performance RF applications.

This switch is a pin-compatible four throw version of the PE42451 with a wider frequency and power supply range. It is comprised of four symmetric RF ports with very high isolation up to 6 GHz. An integrated CMOS decoder facilitates a two- or three-pin 1.8V CMOS control interface. In addition, no external blocking capacitors are required if 0 VDC is present on the RF ports.

The PE42442 is manufactured on Peregrine's UltraCMOS® process, a patented variation of silicon-on-insulator (SOI) technology on a sapphire substrate.

Peregrine's HaRP technology enhancements deliver high linearity and excellent harmonics performance. It is an innovative feature of the UltraCMOS process, offering the performance of GaAs with the economy and integration of conventional CMOS.

Figure 1. Functional Diagram

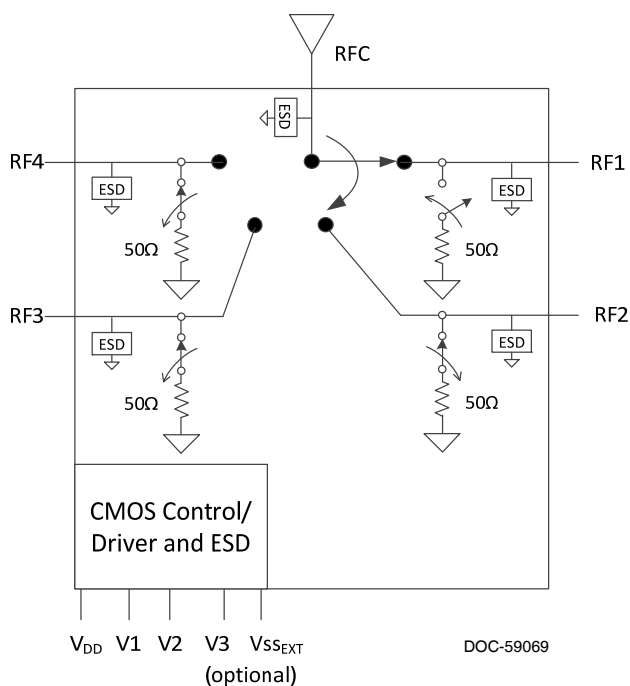

Figure 2. Package Type
24-lead 4 × 4 mm QFN

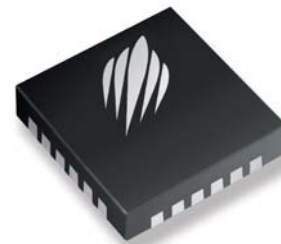

Table 1. Electrical Specifications @ +25 °C ($Z_S = Z_L = 50\Omega$) unless otherwise noted
Normal mode¹: $V_{DD} = 3.3V$, $V_{SS_EXT} = 0V$ or Bypass mode²: $V_{DD} = 3.3V$, $V_{SS_EXT} = -3.3V$

Parameter	Path	Condition	Min	Typ	Max	Unit
Operating frequency			30		6000	MHz
Insertion loss	RFC–RFX	450 MHz		0.85	1.00	dB
		900 MHz		0.90	1.05	dB
		2100 MHz		1.10	1.35	dB
		2700 MHz		1.15	1.40	dB
		4000 MHz		1.25	1.50	dB
		6000 MHz		1.90	2.35	dB
Isolation	RFC–RFX	450 MHz	62	67		dB
		900 MHz	55	61		dB
		2100 MHz	52	55		dB
		2700 MHz	50	52		dB
		4000 MHz	42	43		dB
		6000 MHz	27	32		dB
Isolation	RFX–RFX	450 MHz	61	65		dB
		900 MHz	56	61		dB
		2100 MHz	51	54		dB
		2700 MHz	50	52		dB
		4000 MHz	41	44		dB
		6000 MHz	29	32		dB
Return loss (active port)	RFX	30–4000 MHz		17		dB
		4000–6000 MHz		12		dB
Return loss (terminated port)	RFX	30–4000 MHz		22		dB
		4000–6000 MHz		19		dB
Input 0.1 dB compression point ³	RFC–RFX	900 MHz		35		dBm
Input IP2	RFC–RFX	1900 MHz		97		dBm
Input IP3	RFC–RFX	1900 MHz		58		dBm
Switching time		50% control to 90% or 10% RF		255	330	ns

Notes: 1. Normal mode: single external positive supply used.

2. Bypass mode: both external positive supply and external negative supply used.

3. The input 0.1 dB compression point is a linearity figure of merit. Refer to *Table 3* for the operating RF input power (50Ω).

Figure 3. Pin Configuration (Top View)

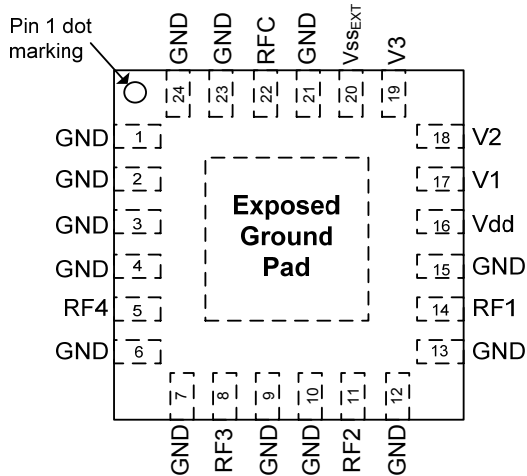

Table 2. Pin Descriptions

Pin #	Name	Description
1-3, 4, 6, 7, 9, 10, 12, 13, 15, 21, 23, 24	GND	Ground
5	RF4 ¹	RF port 4
8	RF3 ¹	RF port 3
11	RF2 ¹	RF port 2
14	RF1 ¹	RF port 1
16	V _{DD}	Supply voltage
17	V1	Digital control logic input 1
18	V2	Digital control logic input 2
19	V3 ²	Digital control logic input 3
20	V _{SS_EXT} ³	External V _{ss} negative voltage control/ground
22	RFC ¹	RF common
Pad	GND	Exposed pad: Ground for proper operation

Notes: 1. RF pins 5, 8, 11, 14 and 22 must be at 0 VDC. The RF pins do not require DC blocking capacitors for proper operation if the 0 VDC requirement is met.
2. Pin 19 must be grounded for 2-pin control, refer to Table 5A.
3. Use V_{SS_EXT} (pin 20, refer to Table 3) to bypass and disable internal negative voltage generator. Connect V_{SS_EXT} (pin 20, V_{SS_EXT} = GND) to enable internal negative voltage generator.

Exceeding absolute maximum ratings may cause permanent damage. Operation should be restricted to the limits in the Operating Ranges table. Operation between operating range maximum and absolute maximum for extended periods may reduce reliability.

Table 3. Operating Ranges

Parameter	Symbol	Min	Typ	Max	Unit
Normal mode ¹					
Supply voltage	V _{DD}	2.3		5.5	V
Supply current	I _{DD}		110		μA
Bypass mode ²					
Supply voltage	V _{DD}	2.7		5.5	V
Supply current	I _{DD}		50		μA
Negative supply voltage	V _{SS_EXT}	-3.6		-3.2	V
Normal or Bypass mode					
Digital input high (V1, V2, V3)	V _{IH}	1.17		3.6	V
Digital input low (V1, V2, V3)	V _{IL}	-0.3		0.6	V
Digital input current ³	I _{CTRL}			1	μA
RF input power, CW	P _{MAX,CW}			33	dBm
RF input power into terminated ports, CW	P _{MAX,TERM}			24	dBm
Operating temperature range	T _{OP}	-40		+105	°C

Notes: 1. Normal mode: connect pin 20 to GND to enable internal negative voltage generator.
2. Bypass mode: apply a negative voltage to V_{SS_EXT} (pin 20) to bypass and disable internal negative voltage generator.
3. The pull-down resistor in the EVK schematic may increase control current.

Table 4. Absolute Maximum Ratings

Parameter/Condition	Symbol	Min	Max	Unit
Supply voltage	V _{DD}	-0.3	5.5	V
Voltage on any DC input	V _I	-0.3	3.6	V
Maximum input power	P _{MAX_ABS}		34	dBm
Storage temperature range	T _{ST}	-65	+150	°C
ESD voltage HBM ¹ All pins RF pins to ground	V _{ESD_HBM}		2.0 4.0	kV kV
ESD voltage MM ² , all pins	V _{ESD_MM}		150	V
ESD voltage CDM ³ , all pins	V _{ESD_CDM}		250	V

Notes: 1. Human Body Model (MIL-STD 883 Method 3015)
2. Machine Model (JEDEC JESD22-A115)
3. Charged Device Model (JEDEC JESD22-C101D)

Electrostatic Discharge (ESD) Precautions

When handling this UltraCMOS device, observe the same precautions that you would use with other ESD-sensitive devices. Although this device contains circuitry to protect it from damage due to ESD, precautions should be taken to avoid exceeding the rating specified.

Latch-Up Avoidance

Unlike conventional CMOS devices, UltraCMOS devices are immune to latch-up.

Switching Frequency

The PE42442 has a maximum 25 kHz switching rate in normal mode (pin 20 = GND). A faster switching rate is available in bypass mode (pin 20 = V_{SS_EXT}). The rate at which the PE42442 can be switched is then limited to the switching time as specified in *Table 1*.

Switching frequency describes the time duration between switching events. Switching time is the time duration between the point the control signal reaches 50% of the final value and the point the output signal reaches within 10% or 90% of its target value.

Moisture Sensitivity Level

The Moisture Sensitivity Level rating for the PE42442 in the 24-lead 4 × 4 mm QFN package is MSL1.

Table 5. Truth Table (3-pin control)*

Mode	V3	V2	V1
Unsupported	0	0	0
RF1 on	0	0	1
RF2 on	0	1	0
RF3 on	0	1	1
RF4 on	1	0	0
All off	1	0	1
All off	1	1	0
Unsupported	1	1	1

Note: * 3-pin control intended for legacy product support to PE42450 and PE42451 or if All Off mode is required. Logic States 000 and 111 are unsupported and should not be used under any operating conditions.

Table 5A. Truth Table (2-pin control)¹⁾²⁾

Mode	V2	V1
RF4 on	0	0
RF1 on	0	1
RF2 on	1	0
RF3 on	1	1

Notes: 1. Pin 19 = V3 must be grounded.
2. 2-pin control is recommended for new product designs if All Off mode is not required.

Optional External V_{SS} Control (V_{SS_EXT})

For applications that require a faster switching rate or spur-free performance, this part can be operated in bypass mode. Bypass mode requires an external negative voltage in addition to an external V_{DD} supply voltage.

As specified in *Table 3*, the external negative voltage (V_{SS_EXT}) when applied to pin 20 will disable and bypass the internal negative voltage generator.

Spurious Performance

The typical low-frequency spurious performance of the PE42442 in normal mode is -120 dBm (pin 20 = GND). If spur-free performance is desired, the internal negative voltage generator can be disabled by applying a negative voltage to V_{SS_EXT} (pin 20).

Typical Performance Data @ 25 °C and $V_{DD} = 3.3V$ unless otherwise noted

Figure 4. Insertion Loss (All Paths)

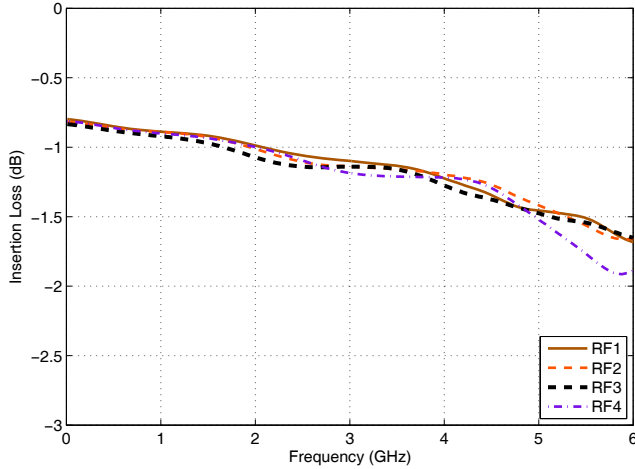

Figure 5. Insertion Loss vs Temp (RFC–RFX)

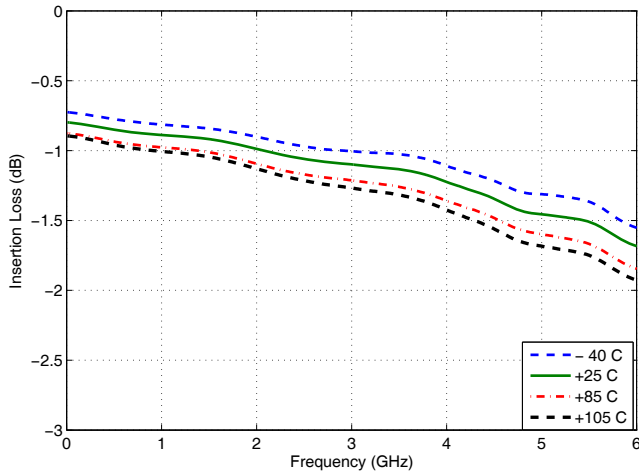
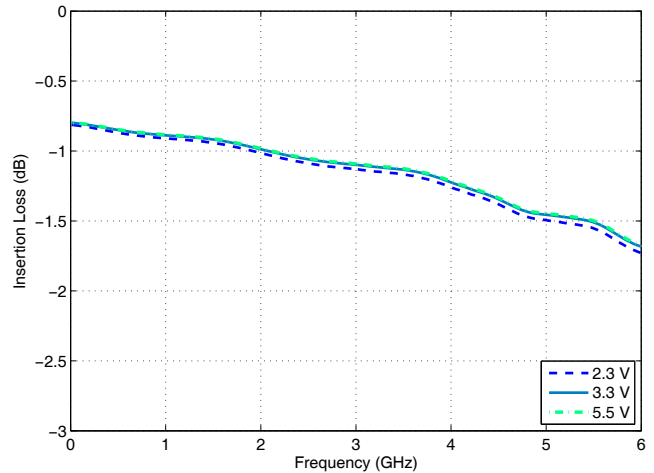

Figure 6. Insertion Loss vs V_{DD} (RFC–RFX)



Typical Performance Data @ 25 °C and $V_{DD} = 3.3V$ unless otherwise noted

Figure 7. Isolation vs Temp (RFC–RFX)

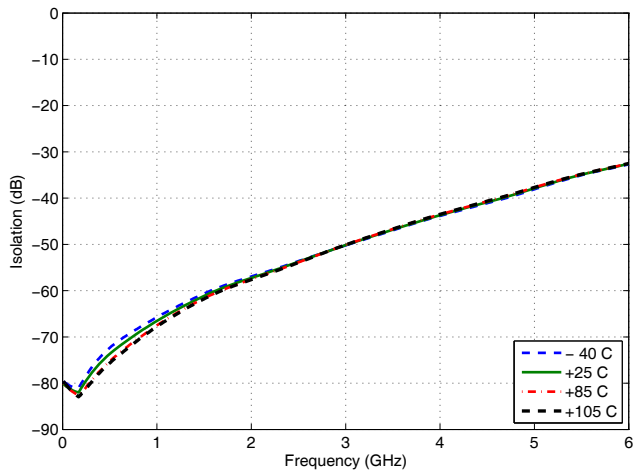

Figure 8. Isolation vs V_{DD} (RFC–RFX)

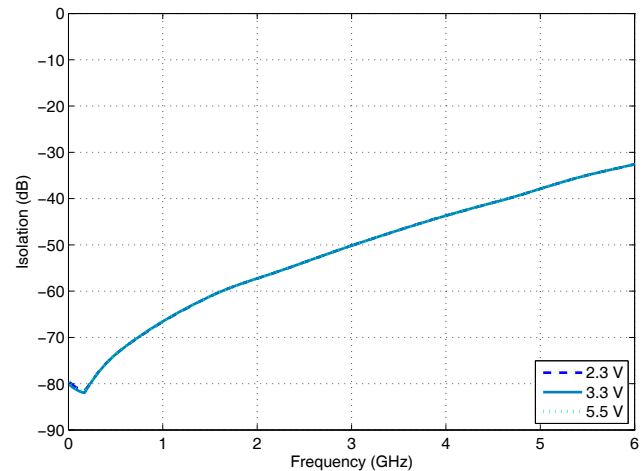

Figure 9. Isolation vs Temp (RFX–RFX)

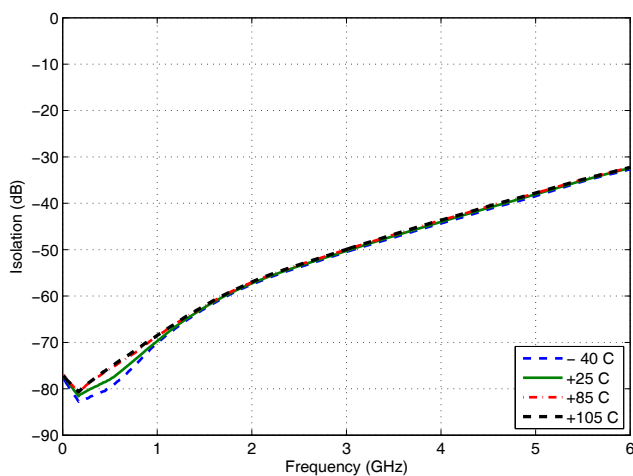
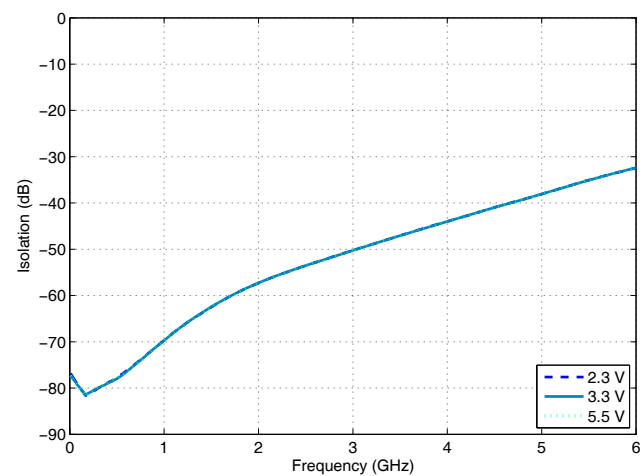

Figure 10. Isolation vs V_{DD} (RFX–RFX)



Typical Performance Data @ 25 °C and $V_{DD} = 3.3V$ unless otherwise noted

Figure 11. Active Port Return Loss vs Temp

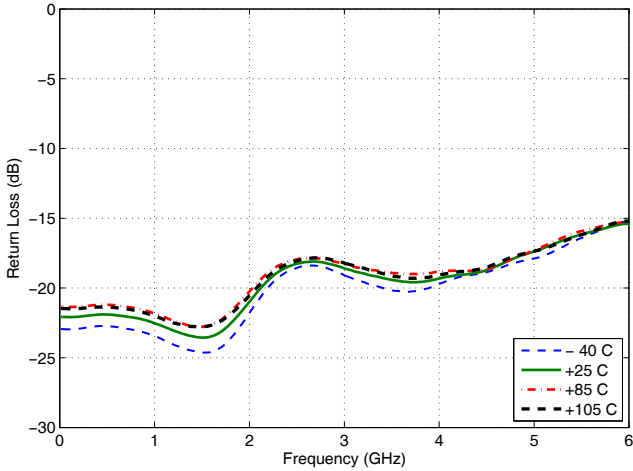

Figure 12. Active Port Return Loss vs V_{DD}

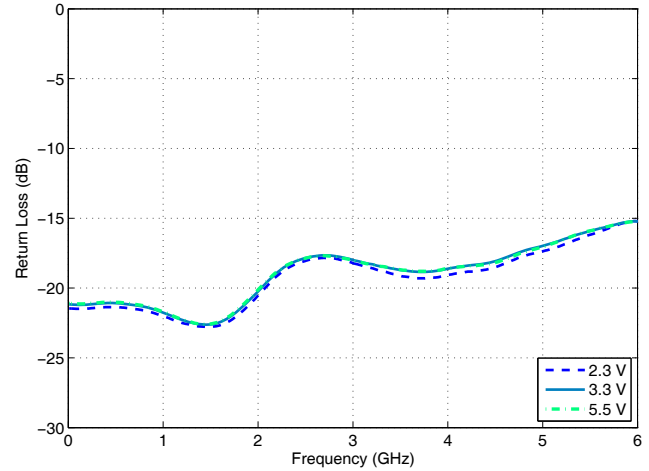

Figure 13. RFC Port Return Loss vs Temp

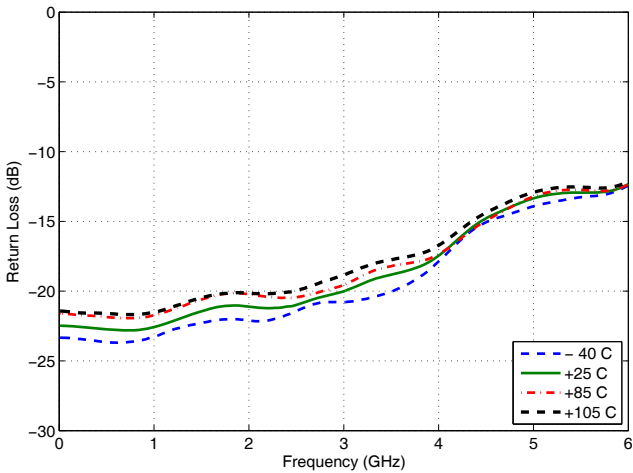

Figure 14. RFC Port Return Loss vs V_{DD}

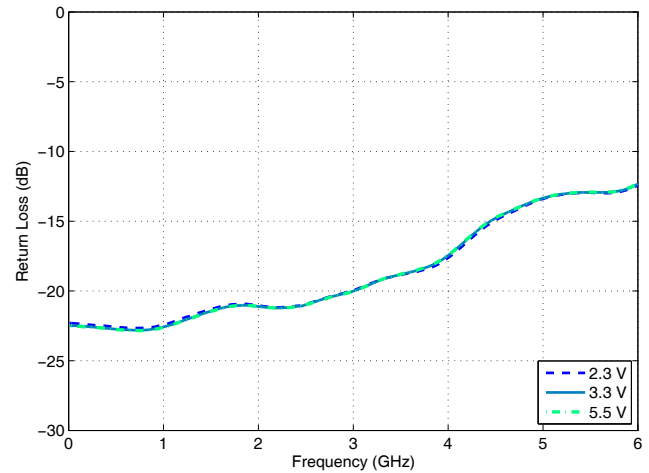

Figure 15. Return Loss (All Ports Terminated)

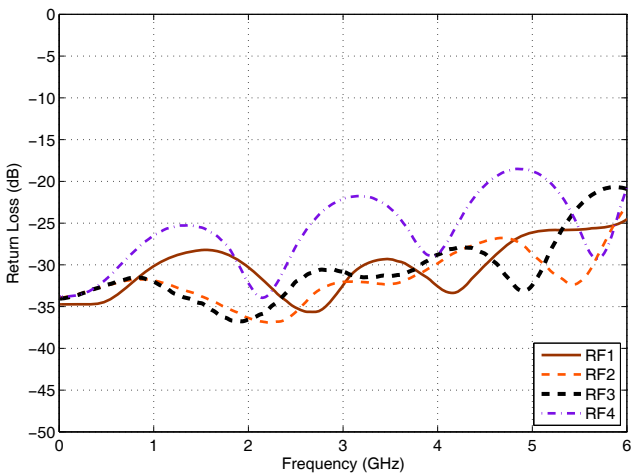
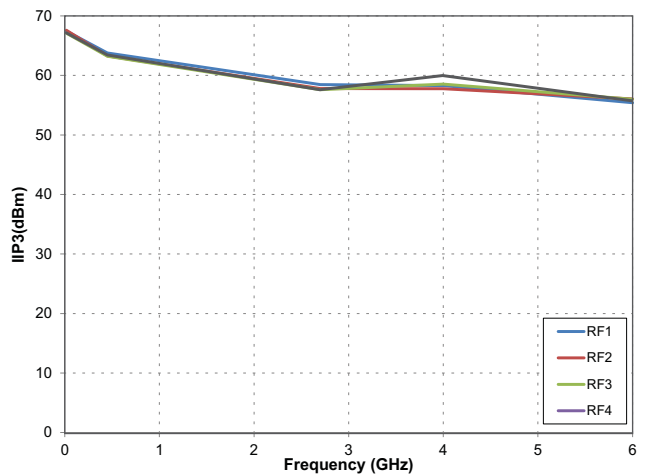

Figure 16. IIP3 vs Frequency



Evaluation Kit

The SP4T switch Evaluation Board was designed to ease customer evaluation of Peregrine's PE42442. The RF common port is connected through a 50Ω transmission line via the top SMA connector. RF1, RF2, RF3, and RF4 are connected through 50Ω transmission lines via side SMA connectors. A through 50Ω transmission is available via SMA connectors RFCAL1 and RFCAL2. This transmission line can be used to estimate the loss of the PCB over the environmental conditions being evaluated.

The EVK board is constructed with four metal layers on dielectric materials of Rogers 4003C and 4450 with a total thickness of 32 mils. Layer 1 and layer 3 provide ground for the 50Ω transmission lines. The 50Ω transmission lines are designed in layer 2 for high isolation purpose and use a stripline waveguide design with a trace width of 9.4 mils and trace metal thickness of 1.8 mils. The board stack up for 50Ω transmission lines has 8 mil thickness of Rogers 4003C between layer 1 and layer 2, and 10 mil thickness of Rogers 4450 between layer 2 and layer 3.

Please consult manufacturer's guidelines for proper board material properties in your application. The PCB should be designed in such a way that RF transmission lines and sensitive DC I/O traces such as V_{SS_EXT} are heavily isolated from one another, otherwise the true performance of the PE42442 will not be yielded.

Figure 17. Evaluation Board Layout

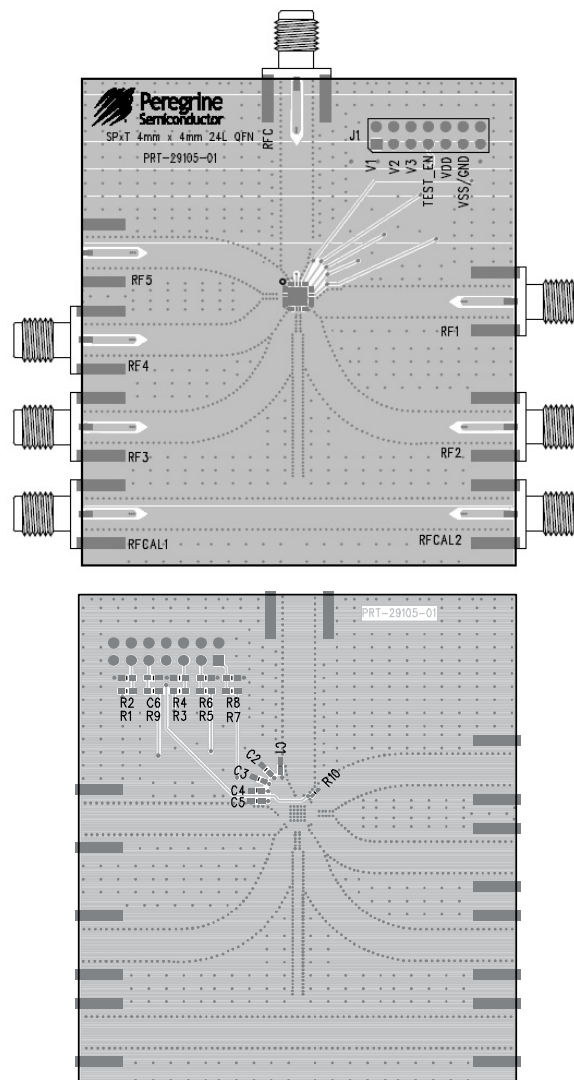

DOC-59282

Figure 18. Evaluation Board Schematic

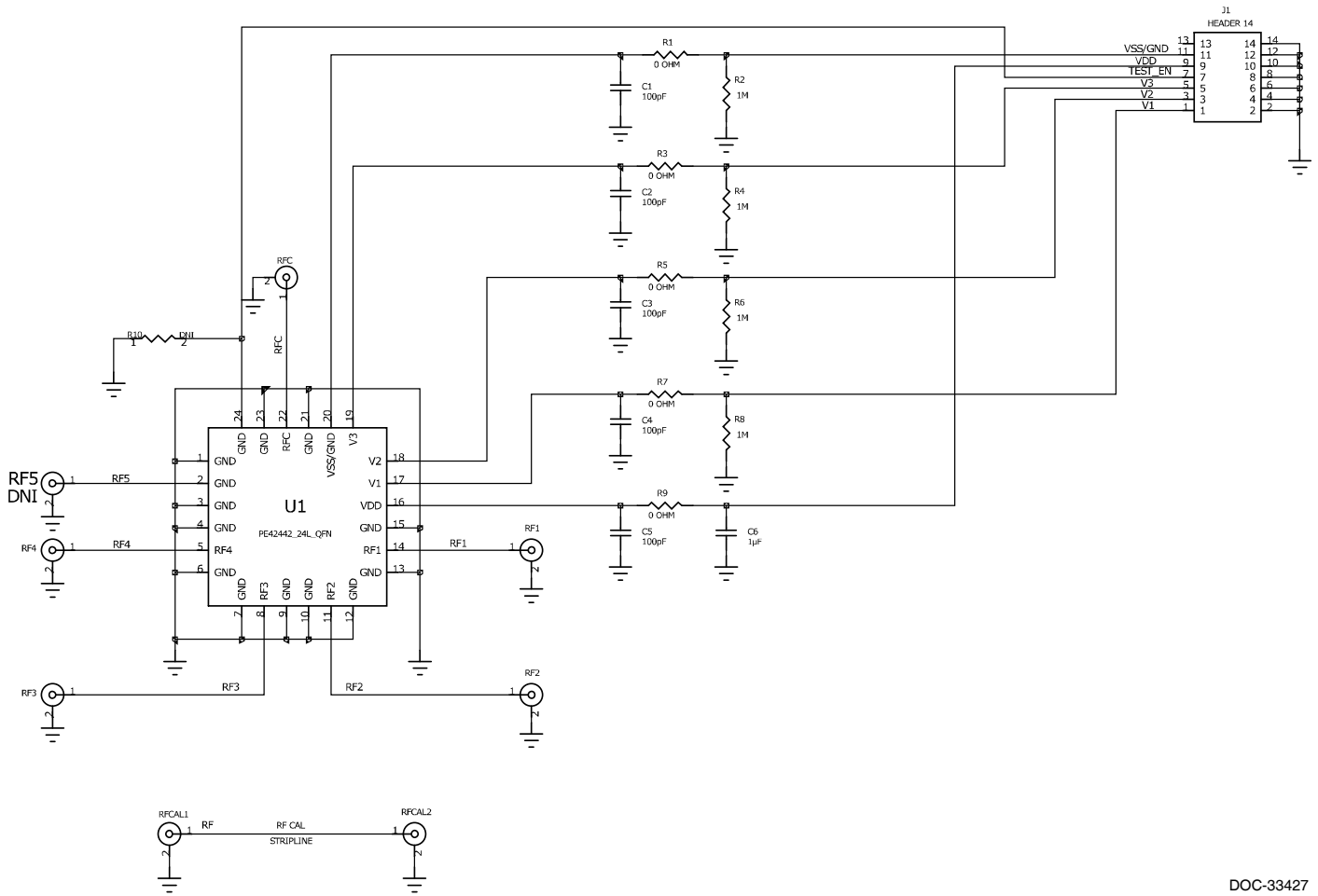

DOC-33427

Figure 19. Package Drawing
24-lead 4 × 4 mm QFN

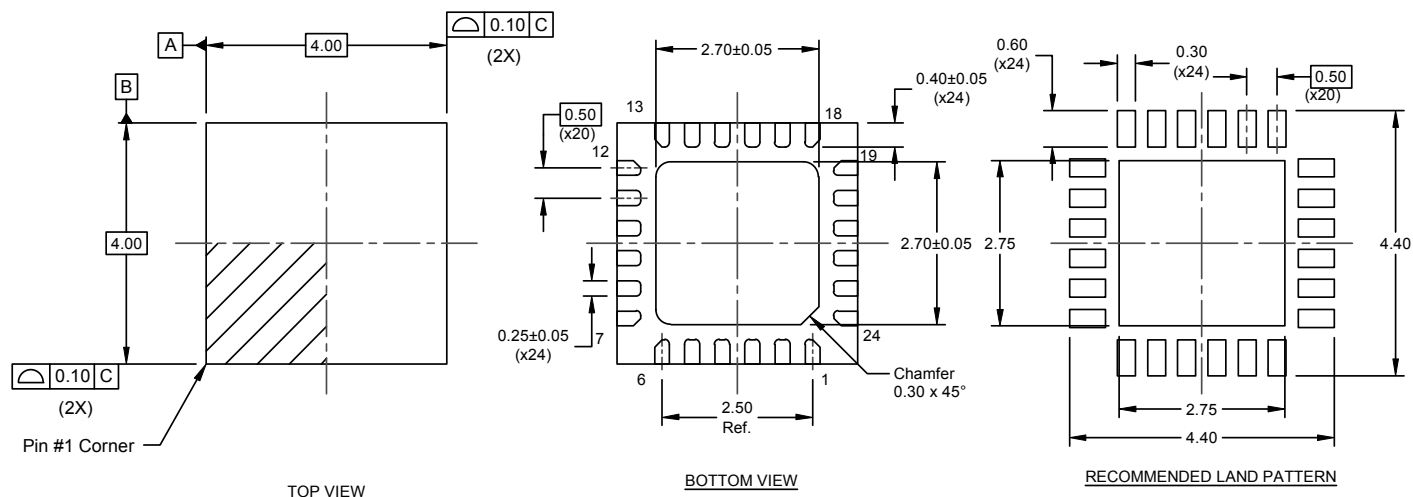

DOC-58197

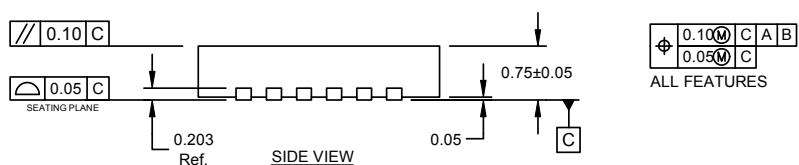
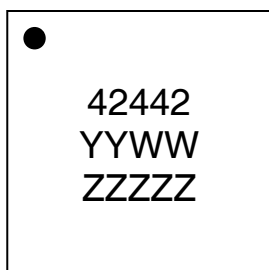

Figure 20. Marking Specifications



DOC-51207

- = Pin 1 designator
- YYWW = Date code
- ZZZZZ = Last five digits of the lot number

Figure 21. Tape and Reel Drawing

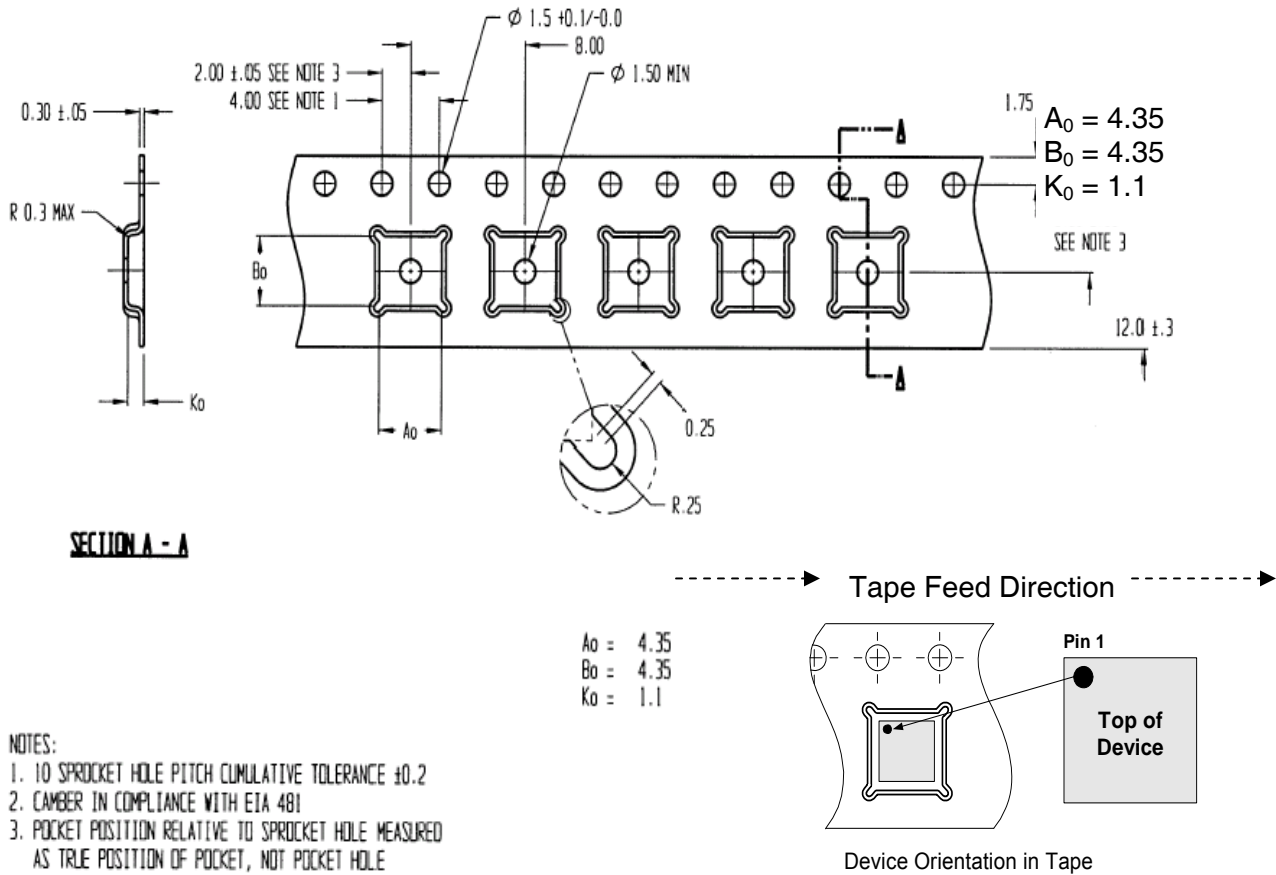

Table 6. Ordering Information

Ordering Code	Description	Package	Shipping Method
PE42442A-Z	PE42442 SP4T RF switch	Green 24-lead 4 × 4 mm QFN	3000 units/T&R
EK42442-01	PE42442 Evaluation kit	Evaluation kit	1/Box

Sales Contact and Information

For sales and contact information please visit www.psemi.com.

Advance Information: The product is in a formative or design stage. The datasheet contains design target specifications for product development. Specifications and features may change in any manner without notice.
Preliminary Specification: The datasheet contains preliminary data. Additional data may be added at a later date. Peregrine reserves the right to change specifications at any time without notice in order to supply the best possible product.
Product Specification: The datasheet contains final data. In the event Peregrine decides to change the specifications, Peregrine will notify customers of the intended changes by issuing a CNF (Customer Notification Form).
 The information in this datasheet is believed to be reliable. However, Peregrine assumes no liability for the use of this information. Use shall be entirely at the user's own risk.

No patent rights or licenses to any circuits described in this datasheet are implied or granted to any third party. Peregrine's products are not designed or intended for use in devices or systems intended for surgical implant, or in other applications intended to support or sustain life, or in any application in which the failure of the Peregrine product could create a situation in which personal injury or death might occur. Peregrine assumes no liability for damages, including consequential or incidental damages, arising out of the use of its products in such applications.

The Peregrine name, logo, UltraCMOS and UTSi are registered trademarks and HaRP, MultiSwitch and DuNE are trademarks of Peregrine Semiconductor Corp. Peregrine products are protected under one or more of the following U.S. Patents: <http://patents.psemi.com>.

Looking for pricing, stock, or lifecycle information?

Click below to explore more details on WIN SOURCE:

- ⊖ [View PE42442A-Z on WIN SOURCE](#)
- ⊖ [Peregrine Semiconductor](#) Information

Optimize Your Supply Chain with WIN SOURCE Solutions

- ✓ Global Sourcing Solution
- ✓ Obsolete Management
- ✓ Cost Control Management
- ✓ Shortage Management
- ✓ Alternative Solution
- ✓ Excess Inventory Management