



**THE DATASHEET OF
LT1579CGN-3.3#PBF**



300mA Dual Input Smart Battery Backup Regulator

FEATURES

- Maintains Output Regulation with Dual Inputs
- Dropout Voltage: 0.4V
- Output Current: 300mA
- 50 μ A Quiescent Current
- No Protection Diodes Needed
- Two Low-Battery Comparators
- Status Flags Aid Power Management
- Adjustable Output from 1.5V to 20V
- Fixed Output Voltages: 3V, 3.3V and 5V
- 7 μ A Quiescent Current in Shutdown
- Reverse-Battery Protection
- Reverse Current Protection
- Remove, Recharge and Replace Batteries Without Loss of Regulation

APPLICATIONS

- Dual Battery Systems
- Battery Backup Systems
- Automatic Power Management for Battery-Operated Systems

LT, LTC and LT are registered trademarks of Linear Technology Corporation.

DESCRIPTION

The LT[®]1579 is a dual input, single output, low dropout regulator. This device is designed to provide an uninterruptible output voltage from two independent input voltage sources on a priority basis. All of the circuitry needed to switch smoothly and automatically between inputs is incorporated.

The LT1579 can supply 300mA of output current from either input at a dropout voltage of 0.4V. Quiescent current is 50 μ A, dropping to 7 μ A in shutdown. Two comparators are included to monitor input voltage status. Two additional status flags indicate which input is supplying power and provide an early warning against loss of output regulation when both inputs are low. A secondary select pin is provided so that the user can force the device to switch from the primary input to the secondary input. Internal protection circuitry includes reverse-battery protection, current limiting, thermal limiting and reverse-current protection.

The device is available in fixed output voltages of 3V, 3.3V and 5V, and as an adjustable device with a 1.5V reference voltage. The LT1579 regulators are available in narrow 16-lead SO and 16-lead SSOP packages with all features, and in SO-8 with limited features.

TYPICAL APPLICATION

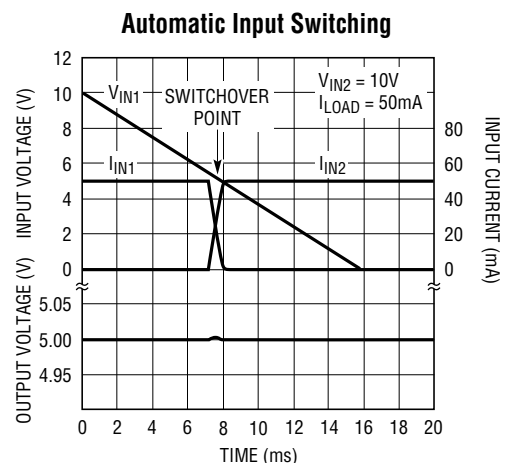
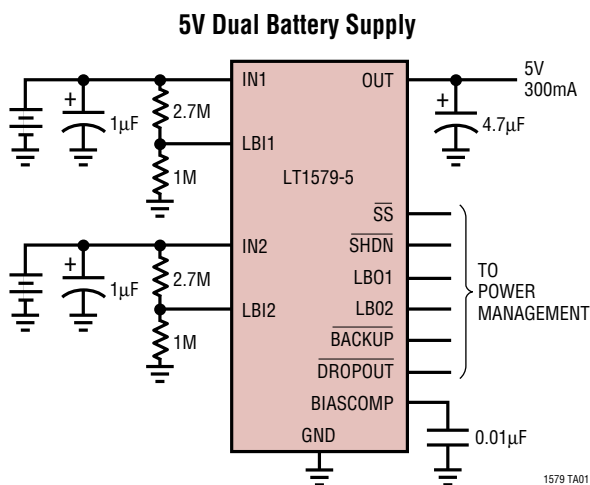

ABSOLUTE MAXIMUM RATINGS

Power Input Pin Voltage	$\pm 20V^*$
Output Pin Voltage	
Fixed Devices	6.5V, -6V
Adjustable Device	$\pm 20V^*$
Output Pin Reverse Current	5mA
ADJ Pin Voltage	2V, -0.6V
ADJ Pin Current	5mA
Control Input Pin Voltage	6.5V, -0.6V
Control Input Pin Current	5mA

BIASCOMP Pin Voltage	6.5V, -0.6V
BIASCOMP Pin Current	5mA
Logic Flag Output Voltage	6.5V, -0.6V
Logic Flag Input Current	5mA
Output Short-Circuit Duration	Indefinite
Storage Temperature Range	-65°C to 150°C
Operating Junction Temperature Range	0°C to 125°C
Lead Temperature (Soldering, 10 sec)	300°C

*For applications requiring input voltage ratings greater than 20V, consult factory.

PACKAGE/ORDER INFORMATION

<p>GN PACKAGE 16-LEAD PLASTIC SSOP</p> <p>S PACKAGE 16-LEAD PLASTIC SO</p> <p>SEE APPLICATION INFORMATION SECTION</p> <p>$T_{JMAX} = 125^{\circ}C, \theta_{JA} = 95^{\circ}C/W$ (GN) $T_{JMAX} = 125^{\circ}C, \theta_{JA} = 68^{\circ}C/W$ (S)</p>	<p>ORDER PART NUMBER</p> <p>LT1579CGN-3 LT1579CGN-3.3 LT1579CGN-5 LT1579CS-3 LT1579CS-3.3 LT1579CS-5</p> <p>GN PART MARKING</p> <p>15793 157933 15795</p>	<p>GN PACKAGE 16-LEAD PLASTIC SSOP</p> <p>S PACKAGE 16-LEAD PLASTIC SO</p> <p>SEE APPLICATION INFORMATION SECTION</p> <p>$T_{JMAX} = 125^{\circ}C, \theta_{JA} = 95^{\circ}C/W$ (GN) $T_{JMAX} = 125^{\circ}C, \theta_{JA} = 68^{\circ}C/W$ (S)</p>	<p>ORDER PART NUMBER</p> <p>LT1579CGN LT1579CS</p> <p>GN PART MARKING</p> <p>1579</p>
<p>S8 PACKAGE 8-LEAD PLASTIC SO</p> <p>SEE APPLICATION INFORMATION SECTION</p> <p>$T_{JMAX} = 125^{\circ}C, \theta_{JA} = 90^{\circ}C/W$</p>	<p>ORDER PART NUMBER</p> <p>LT1579CS8-3 LT1579CS8-3.3 LT1579CS8-5</p> <p>S8 PART MARKING</p> <p>15793 157933 15795</p>	<p>S8 PACKAGE 8-LEAD PLASTIC SO</p> <p>SEE APPLICATION INFORMATION SECTION</p> <p>$T_{JMAX} = 125^{\circ}C, \theta_{JA} = 90^{\circ}C/W$</p>	<p>ORDER PART NUMBER</p> <p>LT1579CS8</p> <p>S8 PART MARKING</p> <p>1579</p>

Consult factory for Industrial and Military grade parts.

ELECTRICAL CHARACTERISTICS

PARAMETER	CONDITIONS		MIN	TYP	MAX	UNITS
Regulated Output Voltage (Note 1)	LT1579-3 $V_{IN1} = V_{IN2} = 3.5V, I_{LOAD} = 1mA, T_J = 25^\circ C$ $4V < V_{IN1} < 20V, 4V < V_{IN2} < 20V, 1mA < I_{LOAD} < 300mA$	●	2.950	3.000	3.050	V
			2.900	3.000	3.100	V
	LT1579-3.3 $V_{IN1} = V_{IN2} = 3.8V, I_{LOAD} = 1mA, T_J = 25^\circ C$ $4.3V < V_{IN1} < 20V, 4.3V < V_{IN2} < 20V, 1mA < I_{LOAD} < 300mA$	●	3.250	3.300	3.350	V
			3.200	3.300	3.400	V
LT1579-5 $V_{IN1} = V_{IN2} = 5.5V, I_{LOAD} = 1mA, T_J = 25^\circ C$ $6V < V_{IN1} < 20V, 6V < V_{IN2} < 20V, 1mA < I_{LOAD} < 300mA$	●	4.925	5.000	5.075	V	
			4.850	5.000	5.150	V
Adjust Pin Voltage	LT1579 $V_{IN1} = V_{IN2} = 3.2V, I_{LOAD} = 1mA, T_J = 25^\circ C$ (Note 2) $3.7V < V_{IN1} < 20V, 3.7V < V_{IN2} < 20V, 1mA < I_{LOAD} < 300mA$	●	1.475	1.500	1.525	V
			1.450	1.500	1.550	V
Line Regulation	LT1579-3 $\Delta V_{IN1} = 3.5V$ to 20V, $\Delta V_{IN2} = 3.5V$ to 20V, $I_{LOAD} = 1mA$	●		1.5	10	mV
	LT1579-3.3 $\Delta V_{IN1} = 3.8V$ to 20V, $\Delta V_{IN2} = 3.8V$ to 20V, $I_{LOAD} = 1mA$	●		1.5	10	mV
	LT1579-5 $\Delta V_{IN1} = 5.5V$ to 20V, $\Delta V_{IN2} = 5.5V$ to 20V, $I_{LOAD} = 1mA$	●		1.5	10	mV
	LT1579 $\Delta V_{IN1} = 3.2V$ to 20V, $\Delta V_{IN2} = 3.2V$ to 20V, $I_{LOAD} = 1mA$ (Note 2)	●		1.5	10	mV
Load Regulation	LT1579-3 $V_{IN1} = V_{IN2} = 4V, \Delta I_{LOAD} = 1mA$ to 300mA, $T_J = 25^\circ C$ $V_{IN1} = V_{IN2} = 4V, \Delta I_{LOAD} = 1mA$ to 300mA	●		3	12	mV
					25	mV
	LT1579-3.3 $V_{IN1} = V_{IN2} = 4.3V, \Delta I_{LOAD} = 1mA$ to 300mA, $T_J = 25^\circ C$ $V_{IN1} = V_{IN2} = 4.3V, \Delta I_{LOAD} = 1mA$ to 300mA	●		3	12	mV
					25	mV
LT1579-5 $V_{IN1} = V_{IN2} = 6V, \Delta I_{LOAD} = 1mA$ to 300mA, $T_J = 25^\circ C$ $V_{IN1} = V_{IN2} = 6V, \Delta I_{LOAD} = 1mA$ to 300mA	●		5	15	mV	
					35	mV
LT1579 $V_{IN1} = V_{IN2} = 3.7V, \Delta I_{LOAD} = 1mA$ to 300mA, $T_J = 25^\circ C$ (Note 2) $V_{IN1} = V_{IN2} = 3.7V, \Delta I_{LOAD} = 1mA$ to 300mA	●		2	10	mV	
					20	mV
Dropout Voltage (Notes 3, 4) $V_{IN1} = V_{IN2} = V_{OUT(NOMINAL)}$	$I_{LOAD} = 10mA, T_J = 25^\circ C$ $I_{LOAD} = 10mA$	●		0.10	0.28	V
					0.39	V
	$I_{LOAD} = 50mA, T_J = 25^\circ C$ $I_{LOAD} = 50mA$	●		0.18	0.35	V
					0.45	V
$I_{LOAD} = 150mA, T_J = 25^\circ C$ $I_{LOAD} = 150mA$	●		0.25	0.47	V	
					0.60	V
$I_{LOAD} = 300mA, T_J = 25^\circ C$ $I_{LOAD} = 300mA$	●		0.34	0.60	V	
					0.75	V
Ground Pin Current (Note 5) $V_{IN1} = V_{IN2} = V_{OUT(NOMINAL)} + 1V$	$I_{LOAD} = 0mA, T_J = 25^\circ C$ $I_{LOAD} = 0mA$	●		50	100	μA
					400	μA
	$I_{LOAD} = 1mA, T_J = 25^\circ C$ $I_{LOAD} = 1mA$	●		100	200	μA
					500	μA
	$I_{LOAD} = 50mA$	●		0.7	1.5	mA
$I_{LOAD} = 150mA$	●		2	4	mA	
$I_{LOAD} = 300mA$	●		5.8	12	mA	
Standby Current (Note 6) $I_{LOAD} = 0mA$	$I_{VIN2}: V_{IN1} = 20V, V_{IN2} = V_{OUT(NOMINAL)} + 0.5V, V_{SS} = \text{Open (HI)}$	●		3.3	7.0	μA
	$I_{VIN1}: V_{IN1} = V_{OUT(NOMINAL)} + 0.5V, V_{IN2} = 20V, V_{SS} = 0V$	●		2.0	7.0	μA
Shutdown Threshold	$V_{OUT} = \text{Off to On}$	●		0.9	2.8	V
	$V_{OUT} = \text{On to Off}$	●	0.25	0.75		V
Shutdown Pin Current (Note 7)	$V_{SHDN} = 0V$	●		1.3	5	μA
Quiescent Current in Shutdown (Note 9)	$I_{VIN1}: V_{IN1} = 20V, V_{IN2} = 6V, V_{SHDN} = 0V$	●		5	12	μA
	$I_{VIN2}: V_{IN1} = 6V, V_{IN2} = 20V, V_{SHDN} = 0V$	●		5	12	μA
	$I_{SRC}: V_{IN1} = V_{IN2} = 20V, V_{SHDN} = 0V$			3		μA

ELECTRICAL CHARACTERISTICS

PARAMETER	CONDITIONS	MIN	TYP	MAX	UNITS	
Adjust Pin Bias Current (Notes 2, 7)	$T_J = 25^\circ\text{C}$		6	30	nA	
Minimum Input Voltage (Note 8)	$I_{\text{LOAD}} = 0\text{mA}$	●	2.7	3.2	V	
Minimum Load Current	LT1579 $V_{\text{IN1}} = V_{\text{IN2}} = 3.2\text{V}$	●		3	μA	
Secondary Select Threshold	Switch from V_{IN2} to V_{IN1}	●	1.2	2.8	V	
	Switch from V_{IN1} to V_{IN2}	●	0.25	0.75	V	
Secondary Select Pin Current (Note 7)	$V_{\text{SS}} = 0\text{V}$	●	1	1.5	μA	
Low-Battery Trip Threshold	$V_{\text{IN1}} = V_{\text{IN2}} = V_{\text{OUT(NOMINAL)}} + 1\text{V}$, High-to-Low Transition	●	1.440	1.500	1.550	V
Low-Battery Comparator Hysteresis	$V_{\text{IN1}} = V_{\text{IN2}} = 6\text{V}$, $I_{\text{LBO}} = 20\mu\text{A}$ (Note 11)	●	18	30	mV	
Low-Battery Comparator Bias Current (Notes 7, 10)	$V_{\text{IN1}} = V_{\text{IN2}} = 6\text{V}$, $V_{\text{LBI}} = 1.4\text{V}$, $T_J = 25^\circ\text{C}$		2	5	nA	
Logic Flag Output Voltage	$I_{\text{SINK}} = 20\mu\text{A}$	●	0.17	0.45	V	
	$I_{\text{SINK}} = 5\text{mA}$	●	0.97	1.3	V	
Ripple Rejection	$V_{\text{IN1}} - V_{\text{OUT}} = V_{\text{IN2}} - V_{\text{OUT}} = 1.2\text{V}$ (Avg), $V_{\text{RIPPLE}} = 0.5\text{V}_{\text{P-P}}$ $f_{\text{RIPPLE}} = 120\text{Hz}$, $I_{\text{LOAD}} = 150\text{mA}$		55	70	dB	
Current Limit	$V_{\text{IN1}} = V_{\text{IN2}} = V_{\text{OUT(NOMINAL)}} + 1\text{V}$, $\Delta V_{\text{OUT}} = -0.1\text{V}$	●	320	400	mA	
Input Reverse Leakage Current	$V_{\text{IN1}} = V_{\text{IN2}} = -20\text{V}$, $V_{\text{OUT}} = 0\text{V}$	●		1.0	mA	
Reverse Output Current	LT1579-3 $V_{\text{OUT}} = 3\text{V}$, $V_{\text{IN1}} = V_{\text{IN2}} = 0\text{V}$		3	12	μA	
	LT1579-3.3 $V_{\text{OUT}} = 3.3\text{V}$, $V_{\text{IN1}} = V_{\text{IN2}} = 0\text{V}$		3	12	μA	
	LT1579-5 $V_{\text{OUT}} = 5\text{V}$, $V_{\text{IN1}} = V_{\text{IN2}} = 0\text{V}$		3	12	μA	

The ● denotes specifications which apply over the full operating temperature range.

Note 1: Operating conditions are limited by maximum junction temperature. The regulated output voltage specification will not apply for all possible combinations of input voltage and output current. When operating at maximum input voltage, output current must be limited. When operating at maximum output current, the input voltage range must be limited.

Note 2: The LT1579 (adjustable version) is tested and specified with the adjust pin connected to the output pin and a 3 μA DC load.

Note 3: Dropout voltage is the minimum input-to-output voltage differential required to maintain regulation at the specified output current. In dropout, the output voltage will be equal to $V_{\text{IN}} - V_{\text{DROPOUT}}$.

Note 4: To meet the requirements for minimum input voltage, the LT1579 (adjustable version) is connected with an external resistor divider for a 3.3V output voltage (see curve of Minimum Input Voltage vs Temperature in the Typical Performance Characteristics). For this configuration, $V_{\text{OUT(NOMINAL)}} = 3.3\text{V}$.

Note 5: Ground pin current will rise at $T_J > 75^\circ\text{C}$. This is due to internal circuitry designed to compensate for leakage currents in the output transistor at high temperatures. This allows quiescent current to be minimized at lower temperatures, yet maintain output regulation at high temperatures with light loads. See the curve of Quiescent Current vs Temperature in the Typical Performance Characteristics.

Note 6: Standby current is the minimum quiescent current for a given input while the other input supplies the load and bias currents.

Note 7: Current flow is out of the pin.

Note 8: Minimum input voltage is the voltage required on either input to maintain the 1.5V reference for the error amplifier and low-battery comparators.

Note 9: Total quiescent current in shutdown will be approximately equal to $I_{\text{VIN1}} + I_{\text{VIN2}} - I_{\text{SRC}}$. Both I_{VIN1} and I_{VIN2} are specified for worst-case conditions. I_{VIN1} is specified under the condition that $V_{\text{IN1}} > V_{\text{IN2}}$ and I_{VIN2} is specified under the condition that $V_{\text{IN2}} > V_{\text{IN1}}$. I_{SRC} is drawn from the highest input voltage only. For normal operating conditions, the quiescent current of the input with the lowest input voltage will be equal to the specified quiescent current minus I_{SRC} . For example, if $V_{\text{IN1}} = 20\text{V}$, $V_{\text{IN2}} = 6\text{V}$ then $I_{\text{VIN1}} = 5\mu\text{A}$ and $I_{\text{VIN2}} = 5\mu\text{A} - 3\mu\text{A} = 2\mu\text{A}$.

Note 10: The specification applies to both inputs independently (LBI1, LBI2).

Note 11: Low-battery comparator hysteresis will change as a function of current in the low-battery comparator output. See the curve of Low-Battery Comparator Hysteresis vs Sink Current in the Typical Performance Characteristics.

TYPICAL PERFORMANCE CHARACTERISTICS

Guaranteed Dropout Voltage

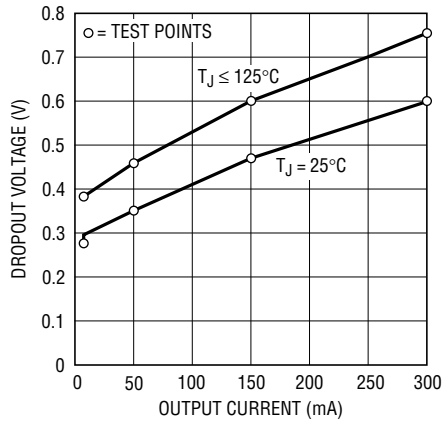

1579 G35

Dropout Voltage

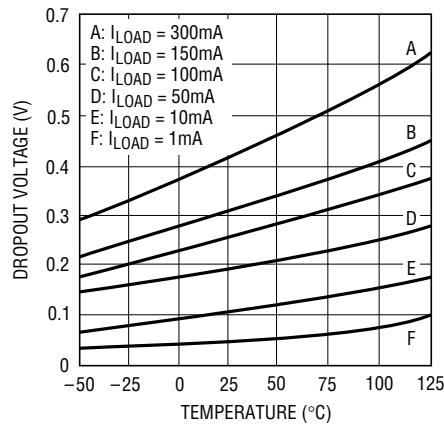

1579 G01

Quiescent Current

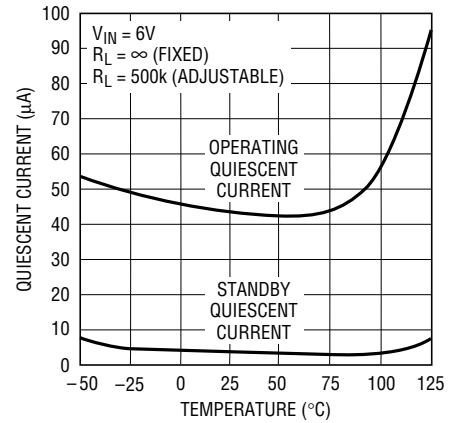

1579 G02

Quiescent Current in Shutdown

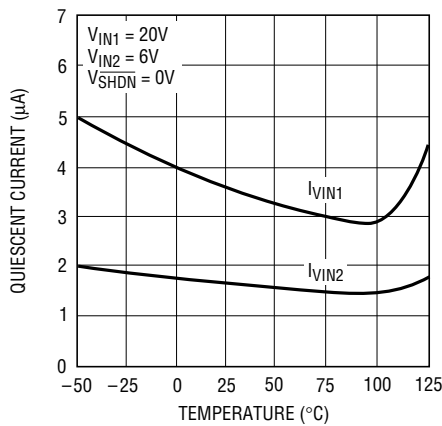

1579 G36

LT1579-3 Output Voltage

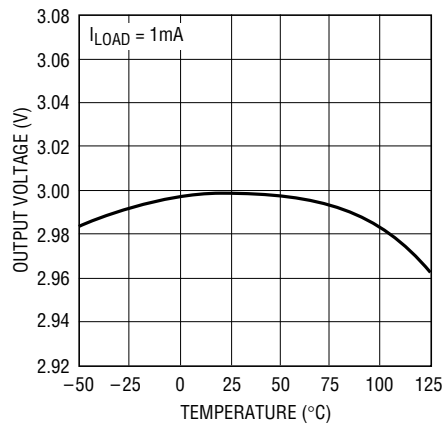

1579 G03

LT1579-3.3 Output Voltage

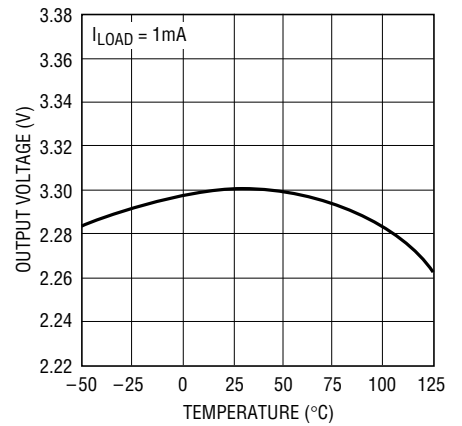

1579 G04

LT1579-5 Output Voltage

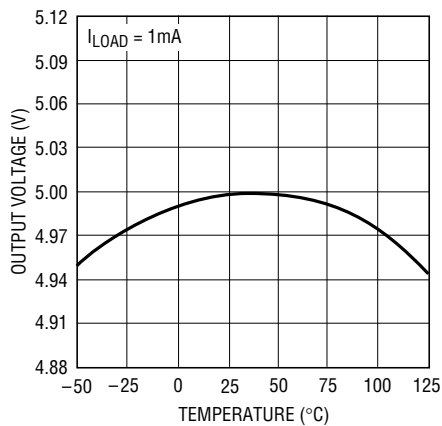

1579 G05

Adjust Pin Voltage

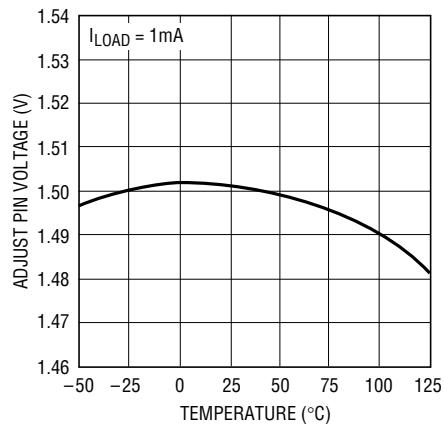

1579 G05

Input Current

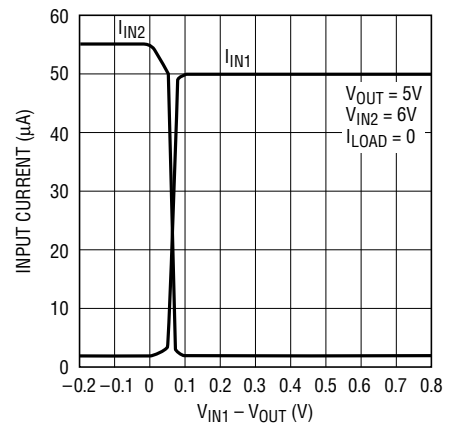

1579 G07

TYPICAL PERFORMANCE CHARACTERISTICS

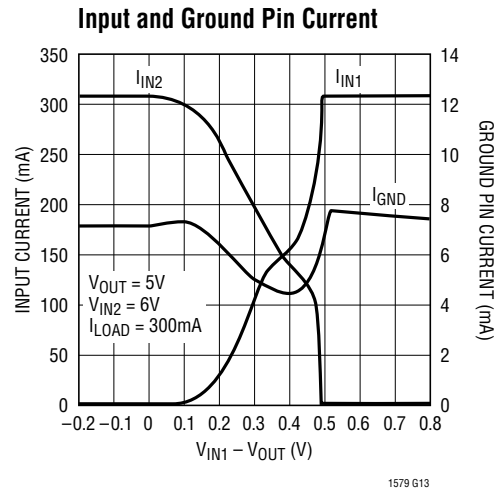
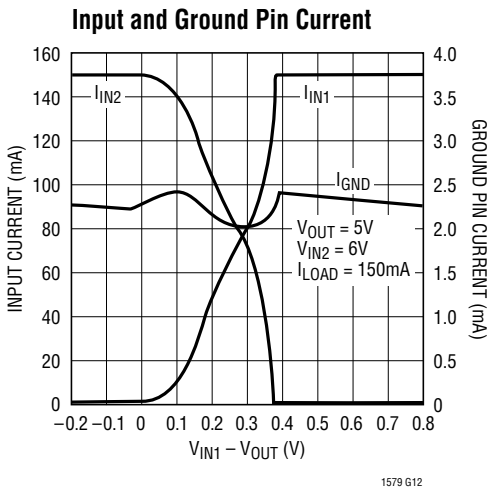
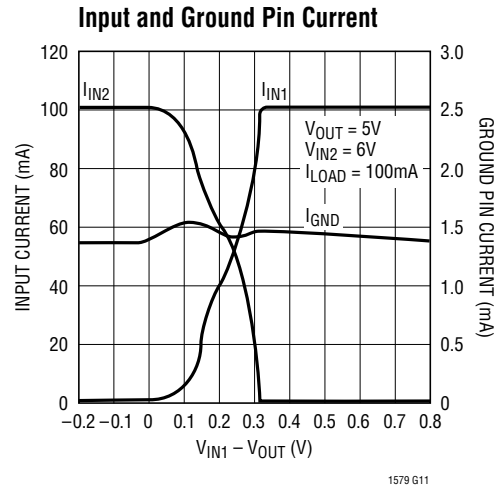
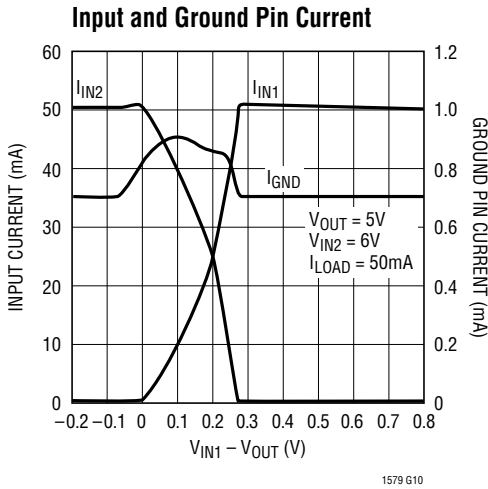
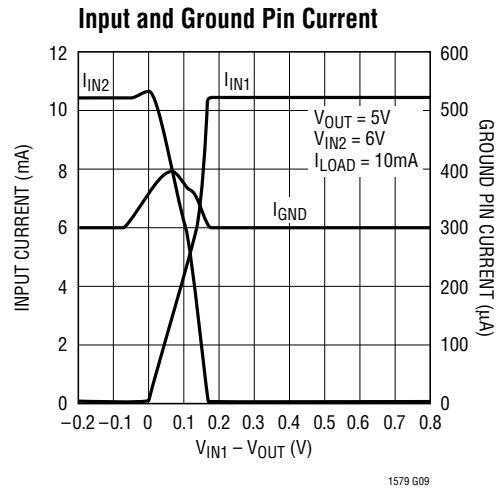
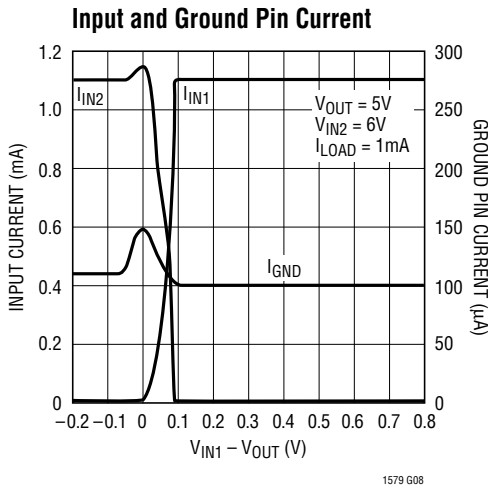

TYPICAL PERFORMANCE CHARACTERISTICS

Ground Pin Current

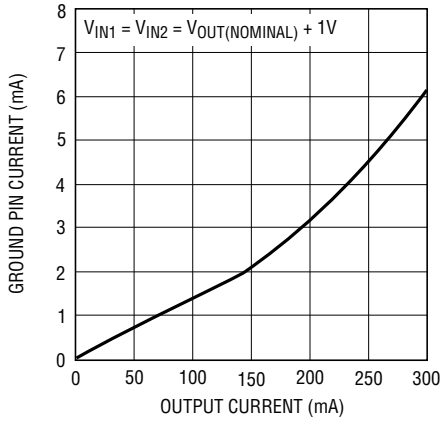

1579 G37

Minimum Input Voltage

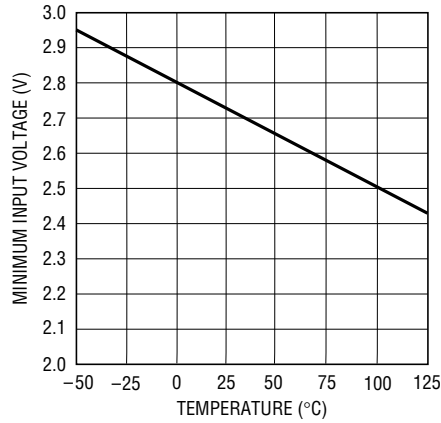

1579 G14

Shutdown Pin Threshold

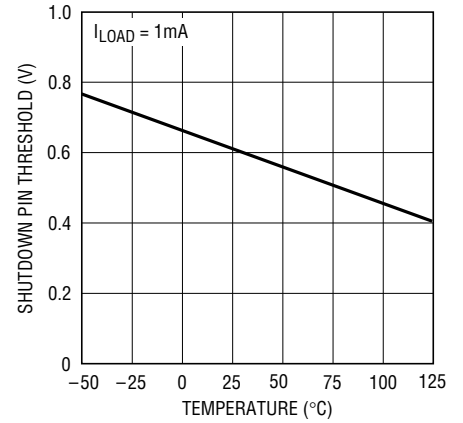

1579 G15

Shutdown Pin Current

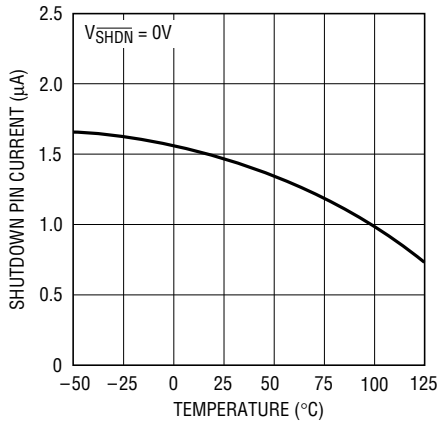

1579 G16

Secondary Select Threshold (Switch to V_{IN2})

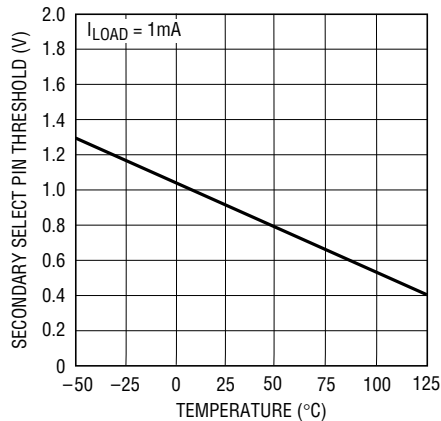

1579 G17

Secondary Select Threshold (Switch to V_{IN1})

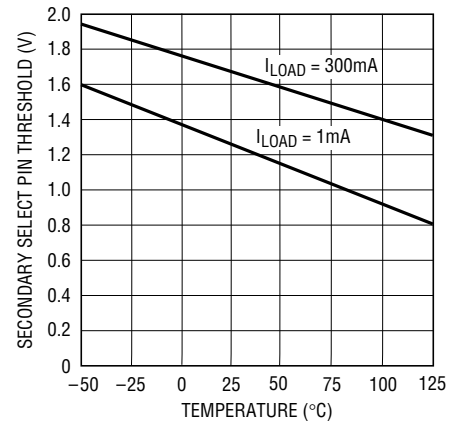

1579 G18

Secondary Select Pin Current

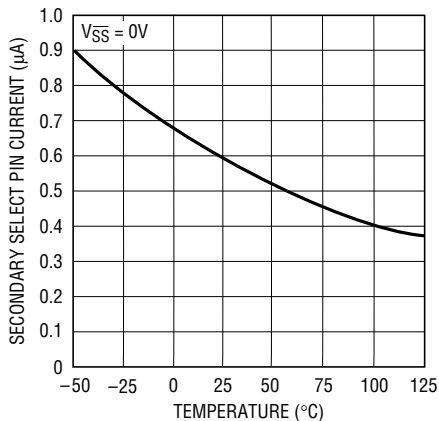

1579 G19

Logic Flag Output Voltage (Output Low)

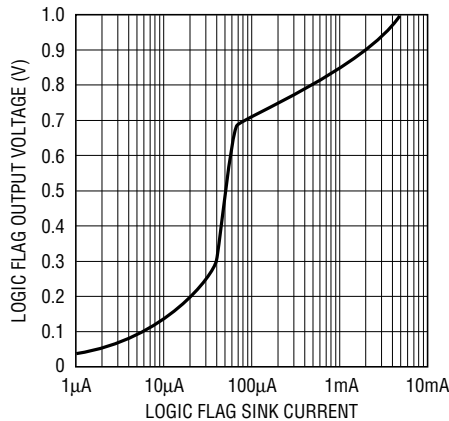

1579 G20

Logic Flag Output Voltage (Output Low)

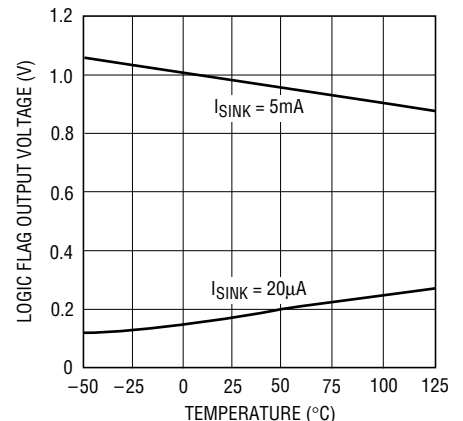

1579 G21

TYPICAL PERFORMANCE CHARACTERISTICS

Logic Flag Input Current (Output High)

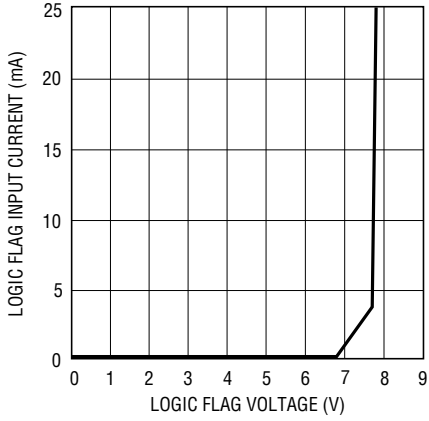

1579 G22

Control Pin Input Current

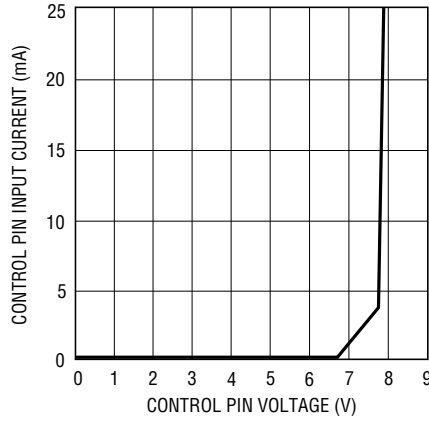

1579 G23

Low-Battery Comparator Hysteresis

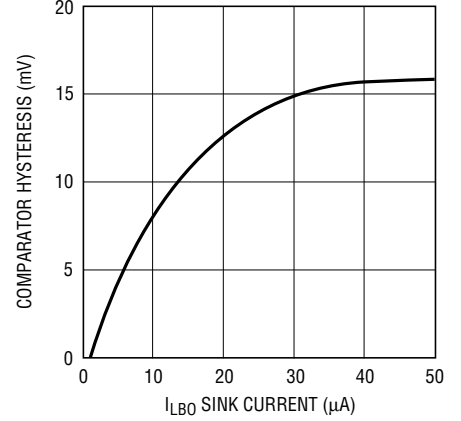

1579 G24

Low-Battery Comparator Hysteresis

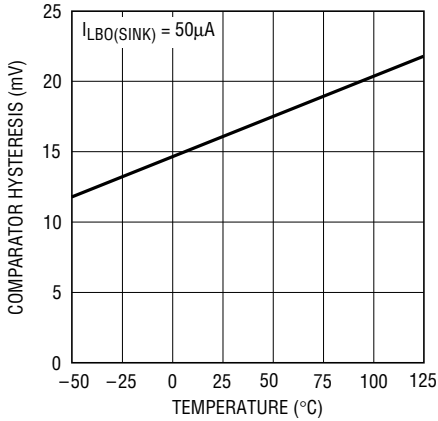

1579 G25

Reverse Output Current

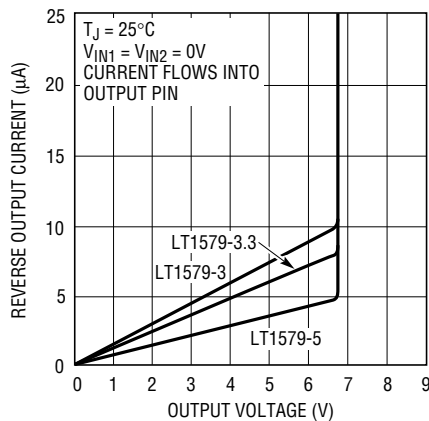

1579 G26

Reverse Output Current

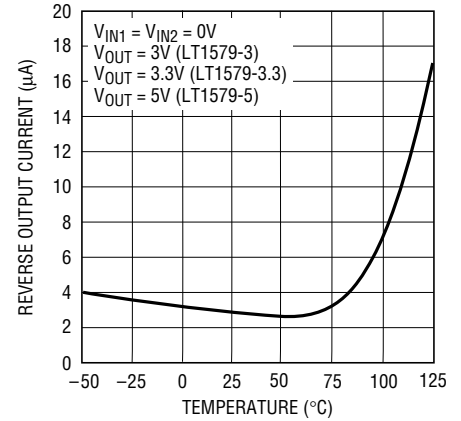

1579 G27

Adjust Pin Input Current

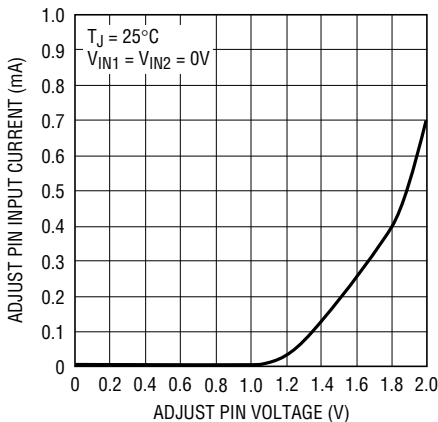

1579 G28

Current Limit

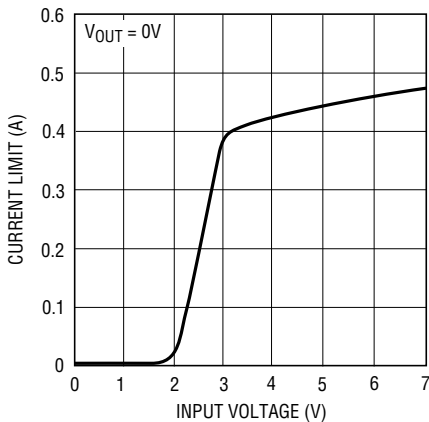

1579 G29

Current Limit

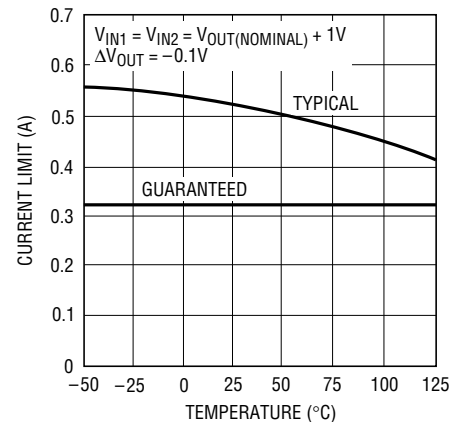

1579 G38

TYPICAL PERFORMANCE CHARACTERISTICS

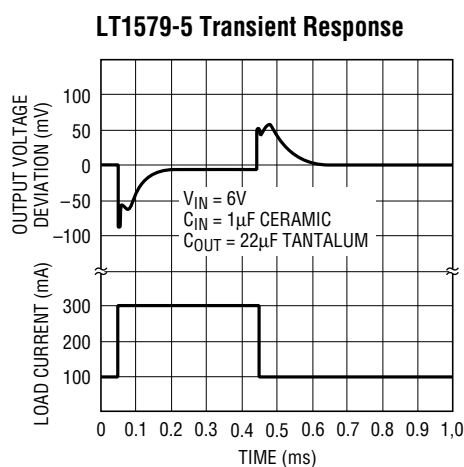
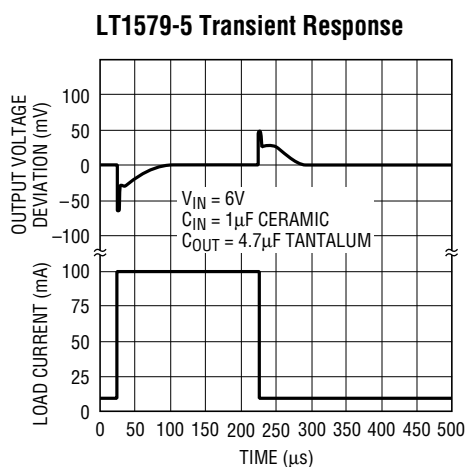
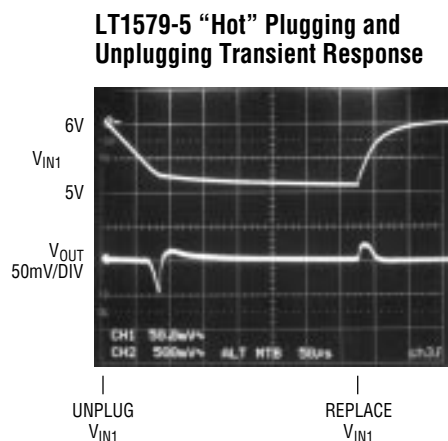
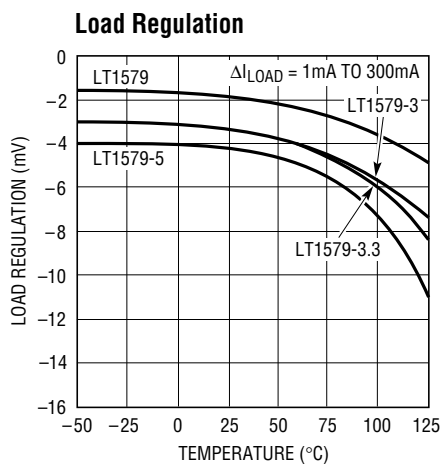
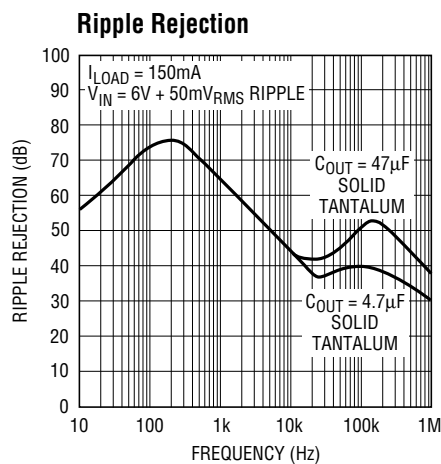

PIN FUNCTIONS

V_{IN1}: The primary power source is connected to V_{IN1}. A bypass capacitor is required on this pin if the device is more than six inches away from the main input filter capacitor. In general, the output impedance of a battery rises with frequency, so it is advisable to include a bypass capacitor in battery-powered circuits. A bypass capacitor in the range of 1µF to 10µF is sufficient.

V_{IN2}: The secondary power source is connected to V_{IN2}. A bypass capacitor is required on this pin if the device is more than six inches away from the main input filter capacitor. In general, the output impedance of a battery

rises with frequency, so it is advisable to include a bypass capacitor in battery-powered circuits. A bypass capacitor in the range of 1µF to 10µF is sufficient.

OUT: The output supplies power to the load. A minimum output capacitor of 4.7µF is required to prevent oscillations. Larger output capacitors will be required for applications with large transient loads to limit peak voltage transients.

ADJ: For the adjustable LT1579, this is the input to the error amplifier. This pin is internally clamped to 7V and -0.6V (one V_{BE}). It has a bias current of 6nA which flows

PIN FUNCTIONS

out of the pin (see curve of Adjust Pin Bias Current vs Temperature in the Typical Performance Characteristics). A DC load of $3\mu\text{A}$ is needed on the output of the adjustable part to maintain regulation. The adjust pin voltage is 1.5V referenced to ground and the output voltage range is 1.5V to 20V.

SHDN: The shutdown pin is used to put the LT1579 into a low power shutdown state. All functions are disabled if the shutdown pin is pulled low. The output will be off, all logic outputs will be high impedance and the voltage comparators will be off when the shutdown pin is pulled low. The shutdown pin is internally clamped to 7V and -0.6V (one V_{BE}), allowing the shutdown pin to be driven either by 5V logic or open collector logic with a pull-up resistor. The pull-up resistor is only required to supply the pull-up current of the open collector gate, normally several microamperes. If unused, the shutdown pin can be left open circuit. The device is active if the shutdown pin is not connected.

SS: The secondary select pin forces the LT1579 to switch power draw to the secondary input (V_{IN2}). This pin is active low. The current drawn out of V_{IN1} is reduced to $3\mu\text{A}$ when this pin is pulled low. The secondary select pin is internally clamped to 7V and -0.6V (one V_{BE}), allowing the pin to be driven directly by either 5V logic or open collector logic with a pull-up resistor. The pull-up resistor is required only to supply the leakage current of the open collector gate, normally several microamperes. If secondary select is not used, it can be left open circuit. The LT1579 draws power from the primary first if the secondary select pin is not connected.

BACKUP: The backup flag is an open collector output which pulls low when the LT1579 starts drawing power from the secondary input (V_{IN2}). The BACKUP output voltage is 1V when sinking 5mA, dropping to under 200mV at $20\mu\text{A}$ (see curve of Logic Flag Voltage vs Current in the Typical Performance Characteristics). This makes the BACKUP pin equally useful in driving both bipolar and CMOS logic inputs with the addition of an external pull-up resistor. It is also capable of driving higher current devices, such as LEDs. This pin is inter-

nally clamped to 7V and -0.6V (one V_{BE}). If unused, this pin can be left open circuit. Device operation is unaffected if this pin is not connected.

DROPOUT: The dropout flag is an open collector output which pulls low when both input voltages drop sufficiently for the LT1579 to enter the dropout region. This signals that the output is beginning to go unregulated. The DROPOUT output voltage is 1V when sinking 5mA, dropping to under 200mV at $20\mu\text{A}$ (see curve of Logic Flag Voltage vs Current in the Typical Performance Characteristics). This makes the DROPOUT pin equally useful in driving both bipolar and CMOS logic inputs with the addition of an external pull-up resistor. It is also capable of driving higher current devices, such as LEDs. This pin is internally clamped to 7V and -0.6V (one V_{BE}). If unused, this pin can be left open circuit. Device operation is unaffected if this pin is not connected.

BIASCOMP: This is a compensation point for the internal bias circuitry. It must be bypassed with a $0.01\mu\text{F}$ capacitor for stability during the switch from V_{IN1} to V_{IN2} .

LB1: This is the noninverting input to low-battery comparator LB1 which is used to detect a low input/battery condition. The inverting input is connected to a 1.5V reference. The low-battery comparator input has 18mV of hysteresis with more than $20\mu\text{A}$ of sink current on the output (see Applications Information section). This pin is internally clamped to 7V and -0.6V (one V_{BE}). If not used, this pin can be left open circuit, with no effect on normal circuit operation. If unconnected, the pin will float to 1.5V and the logic output of LB1 will be high impedance.

LB2: This is the noninverting input to low-battery comparator LB2 which is used to detect a low input/battery condition. The inverting input is connected to a 1.5V reference. The low-battery comparator input has 18mV of hysteresis with more than $20\mu\text{A}$ of sink current on the output (see Applications Information section). This pin is internally clamped to 7V and -0.6V (one V_{BE}). If not used, this pin can be left open circuit, with no effect on normal circuit operation. If unconnected, the pin will float to 1.5V and the logic output of LB2 will be high impedance.

PIN FUNCTIONS

LB01: This is the open collector output of the low-battery comparator LB1. This output pulls low when the comparator input drops below the threshold voltage. The LB01 output voltage is 1V when sinking 5mA, dropping to under 200mV at 20 μ A (see curve of Logic Flag Voltage vs Current in the Typical Performance Characteristics). This makes the LB01 pin equally useful in driving both bipolar and CMOS logic inputs with the addition of an external pull-up resistor. It is also capable of driving higher current devices, such as LEDs. This pin is internally clamped to 7V and $-0.6V$ (one V_{BE}). If unused, this pin can be left open circuit. Device operation is unaffected if this pin is not connected.

LB02: This is the open collector output of the low-battery comparator LB2. This output pulls low when the comparator input drops below the threshold voltage. The LB02 output voltage is 1V when sinking 5mA, dropping to under 200mV at 20 μ A (see curve of Logic Flag Voltage vs Current in the Typical Performance Characteristics). This makes the LB02 pin equally useful in driving both bipolar and CMOS logic inputs with the addition of an external pull-up resistor. It is also capable of driving higher current devices, such as LEDs. This pin is internally clamped to 7V and $-0.6V$ (one V_{BE}). If unused, this pin can be left open circuit. Device operation is unaffected if this pin is not connected.

BLOCK DIAGRAM

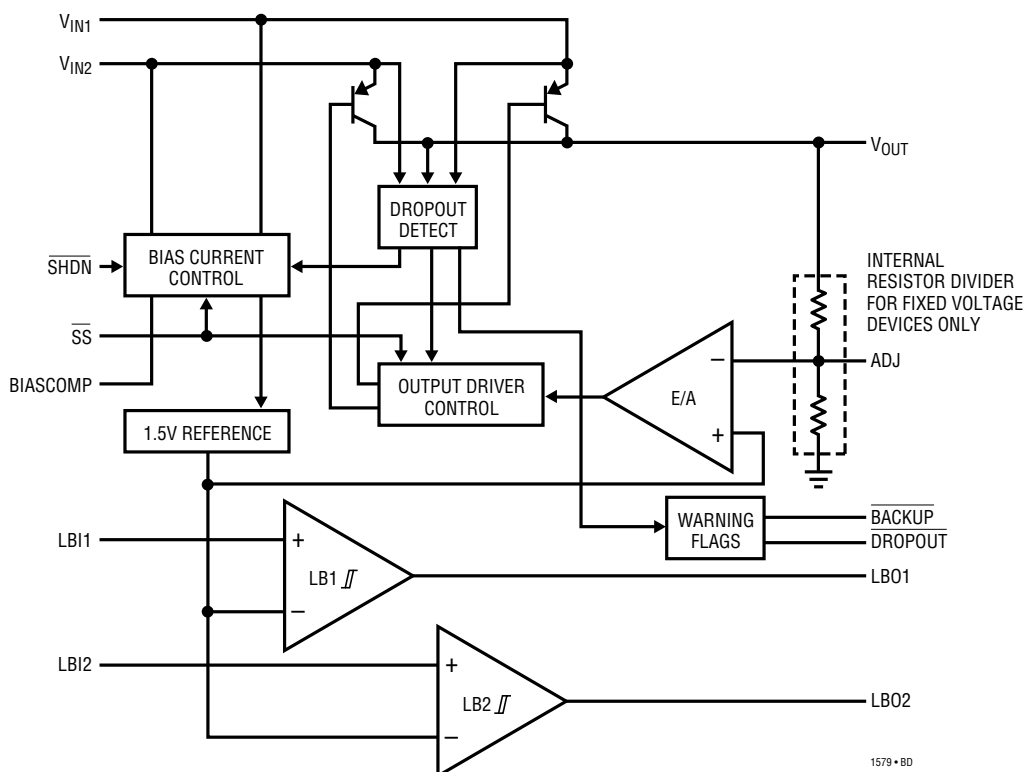

1579 • BD

APPLICATIONS INFORMATION

Device Overview

The LT1579 is a dual input, single output, low dropout linear regulator. The device is designed to provide an uninterruptible output voltage from two independent input voltage sources on a priority basis. All of the circuitry needed to switch smoothly and automatically between inputs is incorporated in the device. All power supplied to the load is drawn from the primary input (V_{IN1}) until the device senses that the primary input is failing. At this point the LT1579 smoothly switches from the primary input to the secondary input (V_{IN2}) to maintain output regulation. The device is capable of providing 300mA from either input at a dropout voltage of 0.4V. Total quiescent current when operating from the primary input is 50 μ A, which is 45 μ A from the primary input, 2 μ A from the secondary and a minimum input current of 3 μ A which will be drawn from the higher of the two input voltages.

A single error amplifier controls both output stages so regulation remains tight regardless of which input is providing power. Threshold levels for the error amplifier and low-battery detectors are set by the internal 1.5V reference. Output voltage is set by an internal resistor divider for fixed voltage parts and an external divider for adjustable parts. Internal bias circuitry powers the reference, error amplifier, output driver controls, logic flags and low-battery comparators.

The LT1579 aids power management with the use of two independent low-battery comparators and two status flags. The low-battery comparators can be used to monitor the input voltage levels. The $\overline{\text{BACKUP}}$ flag signals when any power is being drawn from the secondary input and the $\overline{\text{DROPOUT}}$ flag provides indication that both input voltages are critically low and the output is unregulated. Additionally, the switch to the secondary input from the primary can be forced externally through the use of the secondary select pin ($\overline{\text{SS}}$). This active low logic pin, when pulled below the threshold, will cause power draw to switch from the primary input to the secondary input. Current flowing in the primary input is reduced to only a few microamperes, while all power draw (load current and bias currents) switches to the secondary. The LT1579 has a low power shutdown state which shuts off all bias

currents and logic functions. In shutdown, quiescent currents are 2 μ A from the primary input, 2 μ A from the secondary input and an additional 3 μ A which is drawn from the higher of the two input voltages.

Adjustable Operation

The adjustable version of the LT1579 has an output voltage range of 1.5V to 20V. The output voltage is set by the ratio of two external resistors as shown in Figure 1. The device servos the output to maintain the voltage at the adjust pin at 1.5V. The current in R1 is then equal to 1.5V/R1 and the current in R2 is the current in R1 minus the adjust pin bias current. The adjust pin bias current, 6nA at 25°C, flows out of the adjust pin through R1 to ground. The output voltage can now be calculated using the formula:

$$V_{OUT} = 1.5V \left(1 + \frac{R2}{R1} \right) - (I_{ADJ})(R2)$$

The value of R1 should be less than 500k to minimize the error in the output voltage caused by adjust pin bias current. With 500k resistors for both R1 and R2, the error induced by adjust pin bias current at 25°C is 3mV or 0.1% of the total output voltage. With appropriate value and tolerance resistors, the error due to adjust pin bias current may often be ignored. Note that in shutdown, the output is turned off and the divider current is zero. The parallel combination of R1 and R2 should be greater than 20k to allow the error amplifier to start. In applications where the minimum parallel resistance requirement cannot be met, a 20k resistor may be placed in series with the adjust pin. This introduces an error in the reference point for the resistor divider equal to $(I_{ADJ})(20k)$.

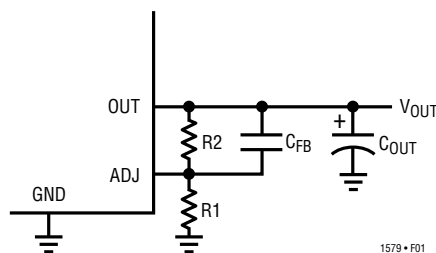

Figure 1. Adjustable Operation

APPLICATIONS INFORMATION

A small capacitor placed in parallel with the top resistor (R2) of the output divider is necessary for stability and transient performance of the adjustable LT1579. The impedance of C_{FB} at 10kHz should be less than the value of R1.

The adjustable LT1579 is tested and specified with the output pin tied to the adjust pin and a 3μA load (unless otherwise noted) for an output voltage of 1.5V. Specifications for output voltages greater than 1.5V are proportional to the ratio of the desired output voltage to 1.5V; (V_{OUT}/1.5V). For example, load regulation for an output current change of 1mA to 300mA is -2mV typical at V_{OUT} = 1.5V. At V_{OUT} = 12V, load regulation is:

$$\left(\frac{12V}{1.5V}\right)(-2mV) = -16mV$$

Output Capacitance and Transient Response

The LT1579 is designed to be stable with a wide range of output capacitors. The ESR of the output capacitor affects stability, most notably with small capacitors. A minimum output capacitor of 4.7μF with an ESR of 3Ω or less is recommended to prevent oscillations. Smaller value capacitors may be used, but capacitors which have a low ESR (i.e. ceramics) may need a small series resistor added to bring the ESR into the range suggested in Table 1. The LT1579 is a micropower device and output transient response is a function of output capacitance. Larger values of output capacitance decrease the peak deviations and provide improved output transient response for larger load current changes. Bypass capacitors, used to decouple individual components powered by the LT1579, will increase the effective output capacitor value.

Table 1. Suggested ESR Range

OUTPUT CAPACITANCE	SUGGESTED ESR RANGE
1.5μF	1Ω to 3Ω
2.2μF	0.5Ω to 3Ω
3.3μF	0.2Ω to 3Ω
≥4.7μF	0Ω to 3Ω

BIASCOMP Pin Compensation

The BIASCOMP pin is a connection to a compensation point for the internal bias circuitry. It must be bypassed with a 0.01μF capacitor for stability during the switch from V_{IN1} to V_{IN2}.

“Hot” Plugging and Unplugging of Inputs

The LT1579 is designed to maintain regulation even if one of the outputs is instantaneously removed. If the primary input is supplying load current, removal and insertion of the secondary input creates no noticeable transient at the output. In this case, the LT1579 continues to supply current from the primary; no switching is required. However, when load current is being supplied from the primary input and it is removed, load current must be switched from the primary to the secondary input. In this case, the LT1579 sees the input capacitor as a rapidly discharging battery. If it discharges too quickly, the LT1579 does not have ample time to switch over without a large transient occurring at the output. The input capacitor must be large enough to supply load current during the transition from primary to secondary input. Replacement of the primary creates a smaller transient on the output because both inputs are present during the transition. For a 100mA load, input and output capacitors of 10μF will limit peak output deviations to less than 50mV. See the “Hot” Plugging and Unplugging Transient Response in the Typical Performance Characteristics. Proportionally larger values for input and output capacitors are needed to limit peak deviations on the output when delivering larger load currents.

Standby Mode

“Standby” mode is where one input draws a minimum quiescent current when the other input is delivering all bias and load currents. In this mode, the standby current is the quiescent current drawn from the standby input. The secondary input will be in standby mode, when the primary input is delivering all load and bias currents. When the secondary input is in standby mode the current drawn from the secondary input will be 3μA if V_{IN1} > V_{IN2} and 5μA

APPLICATIONS INFORMATION

if $V_{IN2} > V_{IN1}$, so typically only $3\mu\text{A}$. The primary input will automatically go into standby mode as the primary input drops below the output voltage. The primary input can also be forced into standby mode by asserting the $\overline{\text{SS}}$ pin. In either case, the current drawn from the primary input is reduced to a maximum of $7\mu\text{A}$.

Shutdown

The LT1579 has a low power shutdown state where all functions of the device are shut off. The device is put into shutdown mode when the shutdown pin is pulled below 0.7V . The quiescent current in shutdown has three components: $2\mu\text{A}$ drawn from the primary, $2\mu\text{A}$ drawn from the secondary and $3\mu\text{A}$ which is drawn from the higher of the two inputs.

Protecting Batteries Using Secondary Select ($\overline{\text{SS}}$)

Some batteries, such as lithium-ion cells, are sensitive to deep discharge conditions. Discharging these batteries below a certain threshold severely shortens battery life. To prevent deep discharge of the primary cells, the LT1579 secondary select ($\overline{\text{SS}}$) pin can be used to switch power draw from the primary input to the secondary. When this pin is pulled low, current out of the primary is reduced to $2\mu\text{A}$. A low-battery detector with the trip point set at the critical discharge point can signal the low battery condition and force the switchover to the secondary as shown in Figure 2. The second low-battery comparator can be used to set a latch to shutdown the LT1579 (see the Typical Applications).

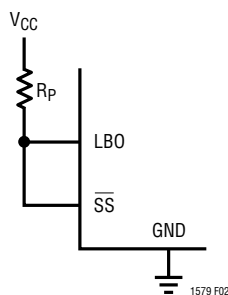
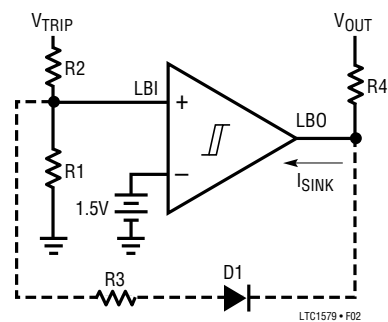

Figure 2. Connecting $\overline{\text{SS}}$ to Low-Battery Detector Output to Prevent Damage to Batteries

Low-Battery Comparators

There are two independent low-battery comparators in the LT1579. This allows for individual monitoring of each input. The inverting inputs of both comparators are connected to an internal 1.5V reference. The low-battery comparator trip point is set by an external resistor divider as shown in Figure 3. The current in $R1$ at the trip point is $1.5\text{V}/R1$. The current in $R2$ is equal to the current in $R1$. The low-battery comparator input bias current, 2nA flowing out of the pin, is negligible and may be ignored. The value of $R1$ should be less than 1.5M in order to minimize errors in the trip point. The value of $R2$ for a given trip point is calculated using the formulas in Figure 3.

The low-battery comparators have a small amount of hysteresis built-in. The amount of hysteresis is dependent upon the output sink current (I_{SINK}) when the comparator is tripped low. At no load, comparator hysteresis is zero, increasing to a maximum of 18mV for sink currents above $20\mu\text{A}$. See the curve of Low-Battery Comparator Hysteresis in the Typical Performance Characteristics. If larger amounts of hysteresis are desired, $R3$ and $D1$ can be added. $D1$ can be any small diode, typically a $1\text{N}4148$. Calculating V_{LBO} can be done using a load line on the curve of Logic Flag Output Voltage vs Sink Current in the Typical Performance Characteristics.



$$R2 = (V_{\text{TRIP}} - 1.5\text{V}) \left(\frac{R1}{1.5\text{V}} \right)$$

$$\text{HYSTERESIS} = V_{\text{HYST}} \left(1 + \frac{R2}{R1} \right)$$

FOR ADDED HYSTERESIS

$$R3 = \frac{(1.5\text{V} + V_{\text{HYST}} - 0.6\text{V} - V_{\text{LBO}})(R2)}{V_{\text{HYST(ADDED)}}}$$

FOR $I_{\text{SINK}} \geq 20\mu\text{A}$, $V_{\text{HYST}} = 18\text{mV}$,
FOR $I_{\text{SINK}} < 20\mu\text{A}$, SEE THE TYPICAL PERFORMANCE CHARACTERISTICS

Figure 3. Low-Battery Comparator Operation

APPLICATIONS INFORMATION

Example: The low-battery detector must be tripped at a terminal voltage of 5.5V. There is a 100k pull-up resistor to 5V on the output of the comparator and 200mV of hysteresis is needed to prevent chatter. With a 1M resistor for R1, what other resistor values are needed?

Using the formulas in Figure 3,

$$R2 = \frac{(5.5V - 1.5V)(1M\Omega)}{1.5V} = 2.67M\Omega$$

Use a standard value of 2.7MΩ. With the 100k pull-up resistor, this gives a sink current and logic flag voltage of approximately 45μA at 0.4V. The hysteresis in this case will be:

$$\text{Hysteresis} = 18mV \left(1 + \frac{2.7M\Omega}{1M\Omega} \right) = 67mV$$

An additional 133mV of hysteresis is needed, so a resistor and diode must be added. The value of R3 will be:

$$R3 = \frac{(1.5V + 18mV - 0.6V - 0.4V)(2.7M\Omega)}{133mV} = 10.5M\Omega$$

A standard value of 10MΩ can be used. The additional current flowing through R3 into the comparator output is negligible and can usually be ignored

Logic Flags

The low-battery comparator outputs and the status flags of the LT1579 are open collector outputs capable of sinking up to 5mA. See the curve of Logic Flag Output Voltage vs. Current in the Typical Performance Characteristics.

There are two status flags on the LT1579. The $\overline{\text{BACKUP}}$ flag and the $\overline{\text{DROPOUT}}$ flag provide information on which input is supplying power to the load and give early warning of loss of output regulation. The $\overline{\text{BACKUP}}$ flag goes low when the secondary input begins supplying power to the load. The $\overline{\text{DROPOUT}}$ flag signals the dropout condition on both inputs, warning of an impending drop in output voltage. The conditions that set either status flag are determined by input to output voltage differentials and

current supplied to the load from each input. Normal output deviation during transient load conditions (with sufficient input voltages) will not set the status flags.

Timing Diagram

The timing diagram for the 5V dual battery supply is shown in Figure 4. The schematic is the same as the 5V Dual Battery Supply on the front of the data sheet. All logic flag outputs have 100k pull-up resistors added. Note that there is no time scale for the timing diagram. The timing diagram is meant as a tool to help in understanding basic operation of the LT1579. Actual discharge rates will be a function of the load current and the type of batteries used. The load current used in the example was 100mA DC.

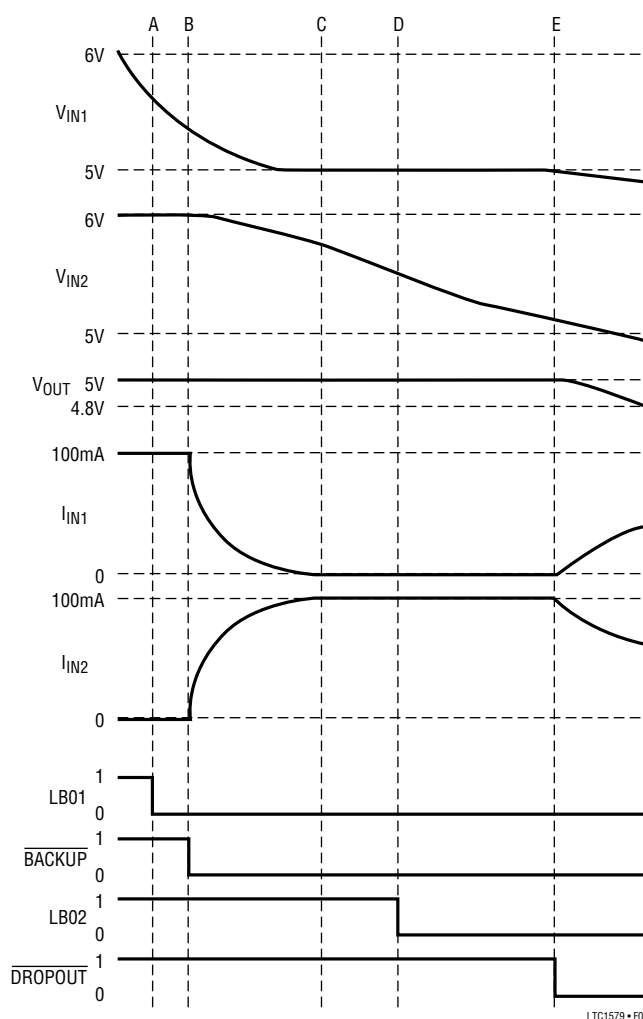

Figure 4. Basic Dual Battery Timing Diagram

APPLICATIONS INFORMATION

Five milestones are noted on the timing diagram. Time A is where the primary input voltage drops enough to trip the low-battery detector LB1. The trip threshold for LB1 is set at set at 5.5V, slightly above the dropout voltage of the primary input. At time B, the $\overline{\text{BACKUP}}$ flag goes low, signaling the beginning of the transition from the primary source to the secondary source. Between times B and C, the input current makes a smooth transition from $V_{\text{IN}1}$ to $V_{\text{IN}2}$. By time C, the primary battery has dropped below the point where it can deliver useful current to the output. The primary input will still deliver a small amount of current to the load, diminishing as the primary input voltage drops. By time D, the secondary battery has dropped to a low enough voltage to trip the second low-battery detector, LB2. The trip threshold for LB2 is also set at 5.5V, slightly above where the secondary input reaches dropout. At time E, both inputs are low enough to cause the LT1579 to enter dropout, with the $\overline{\text{DROPOUT}}$ flag signaling the impending loss of output regulation. After time E, the output voltage drops out of regulation.

Some interesting things can be noted on the timing diagram. The amount of current available from a given input is determined by the input/output voltage differential. As the differential voltage drops, the amount of current drawn from the input also drops, which slows the discharge of the battery. Dropout detection circuitry will maintain the maximum current draw from the input for the given input/output voltage differential. In the case shown, this causes the current drawn from the primary input to approach zero, though never actually dropping to zero. Note that the primary begins to supply significant current again when the output drops out of regulation. This occurs because the input/output voltage differential of the primary input increases as the output voltage drops. The LT1579 will automatically maximize the power drawn from the inputs to maintain the highest possible output voltage.

Thermal Considerations

The power handling capability of the LT1579 is limited by the maximum rated junction temperature (125°C). Power dissipated is made up of two components:

1. The output current from each input multiplied by the respective input to output voltage differential: $(I_{\text{OUT}})(V_{\text{IN}} - V_{\text{OUT}})$ and
2. Ground pin current from the associated inputs multiplied by the respective input voltage: $(I_{\text{GND}})(V_{\text{IN}})$.

If the primary input is not in dropout, all significant power dissipation is from the primary input. Conversely, if SS has been asserted to minimize power draw from the primary, all significant power dissipation will be from the secondary. When the primary input enters dropout, calculation of power dissipation requires consideration of power dissipation from both inputs. Worst-case power dissipation is found using the worst-case input voltage from either input and the worst-case load current.

Ground pin current is found by examining the Ground Pin Current curves in the Typical Performance Characteristics. Power dissipation will be equal to the sum of the two components above for the input supplying power to the load. Power dissipation from the other input is negligible.

The LT1579 has internal thermal limiting designed to protect the device during overload conditions. For continuous normal load conditions, the maximum junction temperature rating of 125°C must not be exceeded. It is important to give careful consideration to all sources of thermal resistance from junction to ambient. Additional heat sources nearby must also be considered.

Heating sinking for the device is accomplished by using the heat spreading capabilities of the PC board and its copper traces. Copper board stiffeners and plated through-holes can also be used to spread the heat. All ground pins on the LT1579 are fused to the die paddle for improved heat spreading capabilities.

The following tables list thermal resistances for each package. Measured values of thermal resistance for several different board sizes and copper areas are listed for each package. All measurements were taken in still air on 3/32" FR-4 board with one ounce copper. All ground leads were connected to the ground plane. All packages for the LT1579 have all ground leads fused to the die attach paddle to lower thermal resistance. Typical thermal

APPLICATIONS INFORMATION

resistance from the junction to a ground lead is 40°C/W for 16-lead SSOP, 32°C/W for 16-lead SO and 35°C/W for 8-lead SO.

Table 2. 8-Lead SO Package (S8)

COPPER AREA		BOARD AREA	THERMAL RESISTANCE (JUNCTION-TO-AMBIENT)
TOPSIDE*	BACKSIDE		
2500 sq mm	2500 sq mm	2500 sq mm	73°C/W
1000 sq mm	2500 sq mm	2500 sq mm	75°C/W
225 sq mm	2500 sq mm	2500 sq mm	80°C/W
100 sq mm	2500 sq mm	2500 sq mm	90°C/W

*Device is mounted on topside.

Table 3. 16-Lead SO Package (S)

COPPER AREA		BOARD AREA	THERMAL RESISTANCE (JUNCTION-TO-AMBIENT)
TOPSIDE*	BACKSIDE		
2500 sq mm	2500 sq mm	2500 sq mm	55°C/W
1000 sq mm	2500 sq mm	2500 sq mm	58°C/W
225 sq mm	2500 sq mm	2500 sq mm	60°C/W
100 sq mm	2500 sq mm	2500 sq mm	68°C/W

*Device is mounted on topside.

Table 4. 16-Lead SSOP Package (GN)

COPPER AREA		BOARD AREA	THERMAL RESISTANCE (JUNCTION-TO-AMBIENT)
TOPSIDE*	BACKSIDE		
2500 sq mm	2500 sq mm	2500 sq mm	70°C/W
1000 sq mm	2500 sq mm	2500 sq mm	75°C/W
225 sq mm	2500 sq mm	2500 sq mm	80°C/W
100 sq mm	2500 sq mm	2500 sq mm	95°C/W

*Device is mounted on topside.

Calculating Junction Temperature

Example: Given an output voltage of 5V, an input voltage range of 5V to 7V for V_{IN1} and 8V to 10V for V_{IN2} , with an output current range of 10mA to 150mA and a maximum ambient temperature of 50°C, what will the maximum junction temperature be?

When run from the primary input, current drawn from the secondary input is negligible and worst-case power dissipation will be:

$$(I_{OUT(MAX)})(V_{IN1(MAX)} - V_{OUT}) + (I_{GND})(V_{IN1(MAX)})$$

Where:

$$I_{OUT(MAX)} = 150\text{mA}$$

$$V_{IN1(MAX)} = 7\text{V}$$

$$I_{GND} \text{ at } (I_{OUT} = 150\text{mA}, V_{IN1} = 7\text{V}) = 2\text{mA}$$

Therefore,

$$P = (150\text{mA})(7\text{V} - 5\text{V}) + (2\text{mA})(7\text{V}) = 0.31\text{W}$$

When switched to the secondary input, current from the primary input is negligible and worst-case power dissipation will be:

$$(I_{OUT(MAX)})(V_{IN2(MAX)} - V_{OUT}) + (I_{GND})(V_{IN2(MAX)})$$

Where:

$$I_{OUT(MAX)} = 150\text{mA}$$

$$V_{IN2(MAX)} = 10\text{V}$$

$$I_{GND} \text{ at } (I_{OUT} = 150\text{mA}, V_{IN2} = 10\text{V}) = 2\text{mA}$$

Therefore,

$$P = (150\text{mA})(10\text{V} - 5\text{V}) + (2\text{mA})(10\text{V}) = 0.77\text{W}$$

Using a 16-lead SO package, the thermal resistance will be in the range of 55°C/W to 68°C/W dependent upon the copper area. So the junction temperature rise above ambient will be approximately equal to:

$$(0.77\text{W})(65^\circ\text{C/W}) = 50.1^\circ\text{C}$$

The maximum junction temperature will then be equal to the maximum temperature rise above ambient plus the maximum ambient temperature or:

$$T_{JMAX} = 50.1^\circ\text{C} + 50^\circ\text{C} = 100.1^\circ\text{C}$$

Protection Features

The LT1579 incorporates several protection features that make it ideal for use in battery-powered circuits. In addition to the normal protection features associated with monolithic regulators, such as current limiting and thermal limiting, the device is protected against reverse input voltages, reverse output voltages and reverse voltages from output to input.

Current limit protection and thermal overload protection are intended to protect the device against current overload conditions at the output of the device. For normal operation, the junction temperature should not exceed 125°C. Current limit protection is designed to protect the device if the output is shorted to ground. With the output shorted to ground, current will be drawn from the primary input until it is discharged. The current drawn from V_{IN2} will not increase until the primary input is discharged. This prevents a short-circuit on the output from discharging both inputs simultaneously.

APPLICATIONS INFORMATION

The inputs of the device can withstand reverse voltages up to 20V. Current flow into the device will be limited to less than 1mA (typically less than 100µA) and no negative voltage will appear at the output. The device will protect both itself and the load. This provides protection against batteries which can be plugged in backwards. Internal protection circuitry isolates the inputs to prevent current flow from one input to the other. Even with one input supplying all bias currents and the other being plugged in backwards (a maximum total differential of 40V), current

flow from one input to another will be limited to less than 1mA. Output voltage will be unaffected. In the case of reverse inputs, no reverse voltages will appear at the load.

Pulling the \overline{SS} pin low will cause all load currents to come from the secondary input. If the secondary input is not present, the output will be turned off. If the part is put into current limit with the \overline{SS} pin pulled low, current limit will be drawn from the secondary input until it is discharged, at which point the current limit will drop to zero.

PACKAGE DESCRIPTION Dimensions in inches (millimeters) unless otherwise noted.

GN Package
16-Lead Plastic SSOP (Narrow 0.150)
 (LTC DWG # 05-08-1641)

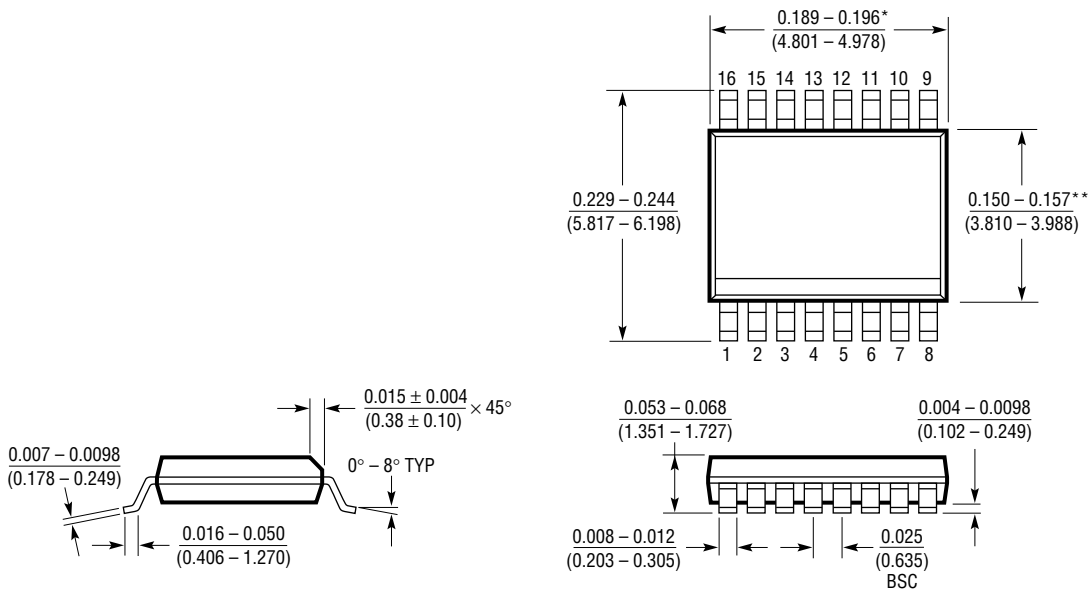

* DIMENSION DOES NOT INCLUDE MOLD FLASH. MOLD FLASH SHALL NOT EXCEED 0.006" (0.152mm) PER SIDE
 ** DIMENSION DOES NOT INCLUDE INTERLEAD FLASH. INTERLEAD FLASH SHALL NOT EXCEED 0.010" (0.254mm) PER SIDE

GN16 (SSOP) 1197

PACKAGE DESCRIPTION Dimensions in inches (millimeters) unless otherwise noted.

S8 Package
8-Lead Plastic Small Outline (Narrow 0.150)
 (LTC DWG # 05-08-1610)

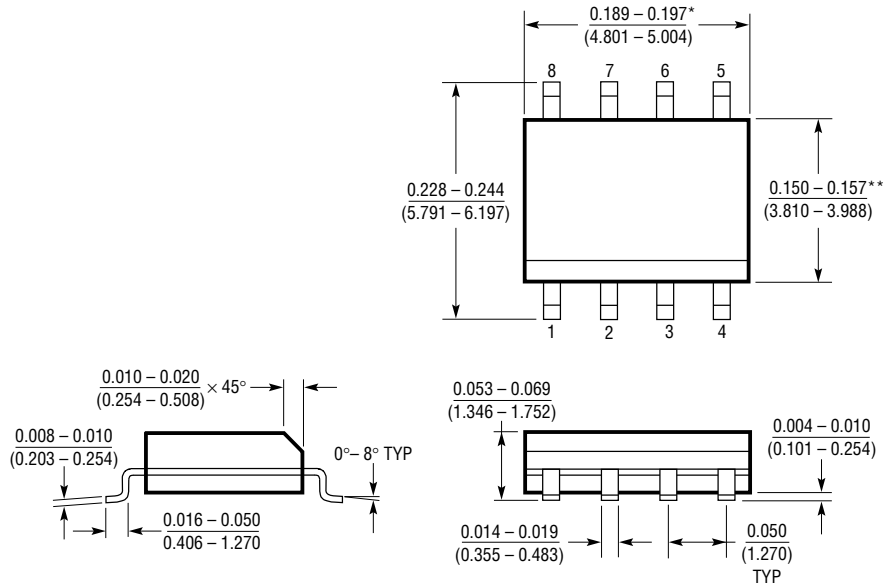

*DIMENSION DOES NOT INCLUDE MOLD FLASH. MOLD FLASH SHALL NOT EXCEED 0.006" (0.152mm) PER SIDE
 **DIMENSION DOES NOT INCLUDE INTERLEAD FLASH. INTERLEAD FLASH SHALL NOT EXCEED 0.010" (0.254mm) PER SIDE

S08 0996

S Package
16-Lead Plastic Small Outline (Narrow 0.150)
 (LTC DWG # 05-08-1610)

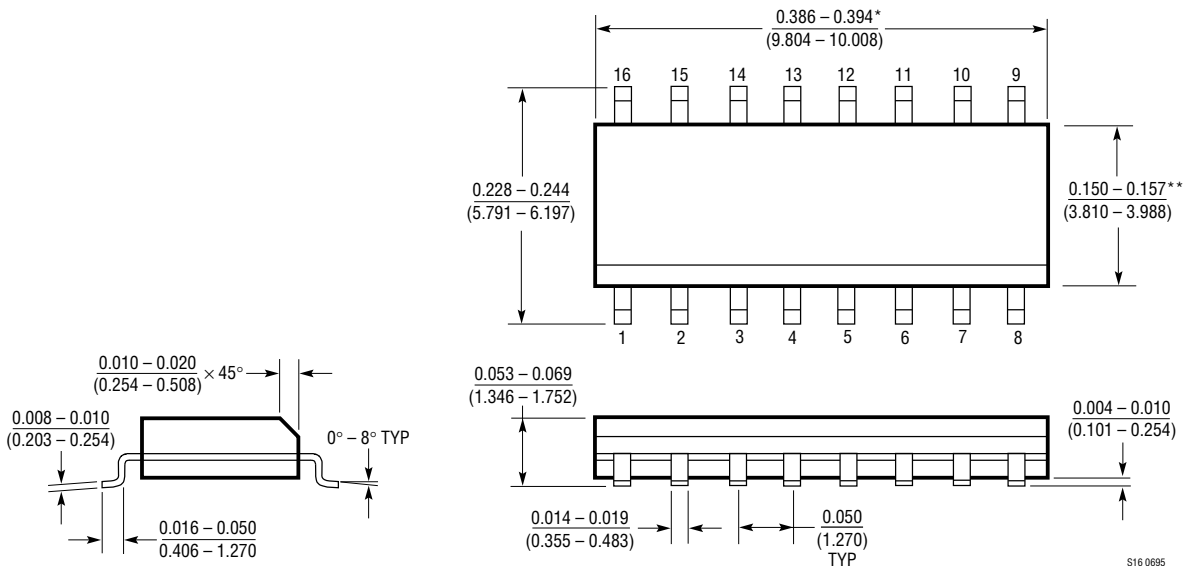

*DIMENSION DOES NOT INCLUDE MOLD FLASH. MOLD FLASH SHALL NOT EXCEED 0.006" (0.152mm) PER SIDE
 **DIMENSION DOES NOT INCLUDE INTERLEAD FLASH. INTERLEAD FLASH SHALL NOT EXCEED 0.010" (0.254mm) PER SIDE

S16 0695

TYPICAL APPLICATION

Additional Logic Forces LT1579 Into Shutdown to Protect Input Batteries

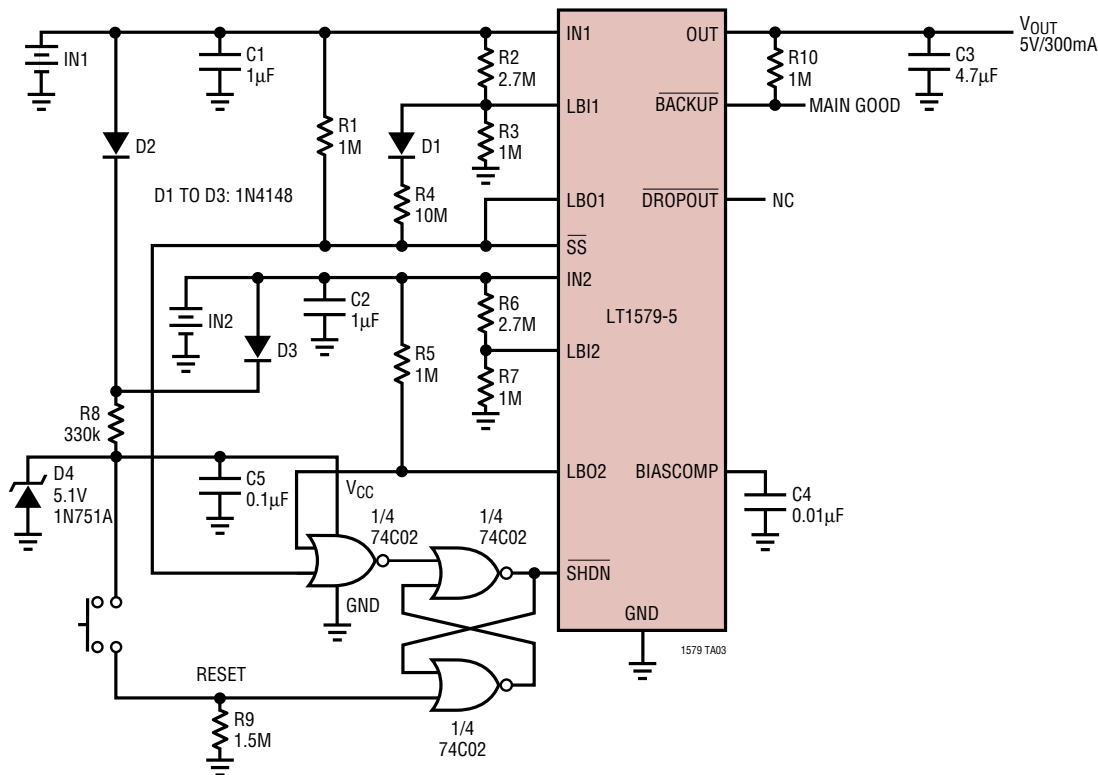

RELATED PARTS

PART NUMBER	DESCRIPTION	COMMENTS
LT1175	500mA Negative Low Dropout Micropower Regulator	Adjustable Current Limit, Shutdown Control
LTC [®] 1421	Hot Swap [™] Controller	Controls Multiple Supplies, 24-Lead SSOP Package
LTC1422	Hot Swap Controller	Controls Single Supply, 8-Lead SO Package
LTC1473	Dual PowerPath [™] Switch Driver	Power Path Management for Systems with Multiple Inputs
LTC1479	PowerPath Controller for Dual Battery Systems	Complete Power Path Management for Two Batteries, DC Power Source, Charger and Backup
LT1521	300mA Low Dropout Micropower Regulator with Shutdown	12μA I _Q , Reverse Battery Protection

Hot Swap and PowerPath are trademarks of Linear Technology Corporation.

Looking for pricing, stock, or lifecycle information?

Click below to explore more details on WIN SOURCE:

 [View LT1579CGN-3.3#PBF on WIN SOURCE](#)

 [Linear Technology](#) Information

Optimize Your Supply Chain with WIN SOURCE Solutions

-  Global Sourcing Solution
-  Obsolete Management
-  Cost Control Management
-  Shortage Management
-  Alternative Solution
-  Excess Inventory Management