



## MAX9502

## 2.5V Video Amplifier with Reconstruction Filter

### General Description

The MAX9502 small, low-power video amplifier with integrated reconstruction filter operates from a supply voltage as low as 2.5V. The small size and the low minimum supply voltage make the MAX9502 ideal for portable applications or small, low-power applications.

The MAX9502 DC-couples the input and the output, resulting in a very small solution. The MAX9502 input can be directly connected to the output of a video digital-to-analog converter (DAC). The reconstruction filter is implemented as a 4th-order Chebyshev with a minimum passband of 5.5MHz, 3dB attenuation at 8MHz, and 55dB attenuation at 27MHz.

The output amplifier provides a closed-loop gain of +6dB (MAX9502G) or +12dB (MAX9502M), and can drive a 2V<sub>P-P</sub> video signal into a 150Ω load to ground. The output signal is level-shifted so the sync tip is 110mV (typ) above ground.

The MAX9502 operates from a 2.5V to 3.6V single supply and consumes only 5.3mA quiescent supply current. An active-low shutdown mode reduces the supply current to 0.01μA.

The MAX9502 is available in tiny 6-pin μDFN (1mm x 1.5mm x 0.8mm) and 5-pin SC70 packages. The device is specified over the -40°C to +85°C extended and -40°C to +125°C automotive temperature ranges.

### Applications

- Mobile Phones
- Digital Still Cameras
- Portable Video
- Security/CCTV

*Pin Configurations appear at end of data sheet.*

### Ordering Information

PART	PIN-PACKAGE	TEMP RANGE	GAIN	TOP MARK
MAX9502GAALT+T	6 μDFN-6	-40°C to +125°C	+6	LI
MAX9502GAAXK+T	5 SC70-5	-40°C to +125°C	+6	ASO
MAX9502GELT+T	6 μDFN-6	-40°C to +85°C	+6	AU
MAX9502GEXK+T	5 SC70-5	-40°C to +85°C	+6	ARV

*Ordering Information continued at end of data sheet.*

+Denotes lead-free package.

### Features

- Tiny 6-Pin μDFN (1mm x 1.5mm x 0.8mm) and 5-Pin SC70 Packages
- DC-Coupled Input and Output Save Board Space
- 4-Pole Chebyshev Filter
- 5.5MHz Passband
- 55dB Attenuation at 27MHz
- 0.01μA Low-Current Shutdown Mode
- 2.5V to 3.6V Single-Supply Operation
- Video Amplifier with Fixed Gains of +6dB (MAX9502G) or +12dB (MAX9502M)

### Typical Operating Circuit

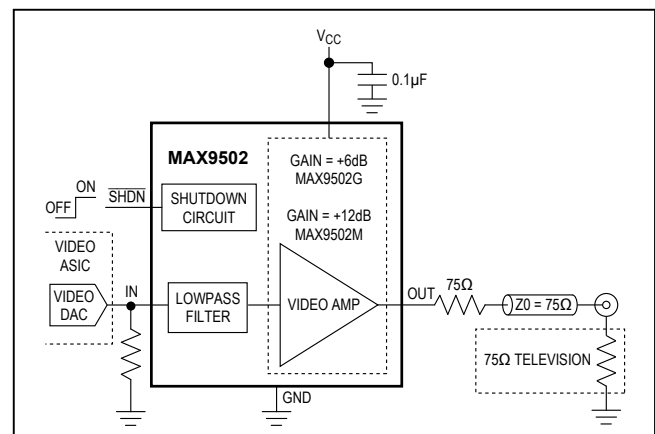

### Other Portable Video Amplifiers

PRODUCT	FEATURES
MAX9503	DirectDrive™, LPF, TQFN
MAX9505	DirectDrive, LPF, analog switch, TQFN
MAX4090	Input clamp, μDFN, SOT23, SC70
MAX9504	Optional DC offset bias, μDFN, SOT23

**Absolute Maximum Ratings**

V<sub>CC</sub> to GND.....-0.3V to +4V  
 SHDN, IN, OUT to GND.....-0.3V to (V<sub>CC</sub> + 0.3V)  
 OUT Short-Circuit Duration to V<sub>CC</sub>, GND.....Continuous  
 Continuous Power Dissipation (T<sub>A</sub> = +70°C)  
   5-Pin SC70 (derate 3.1mW/°C above +70°C) ..... 247mW  
   6-Pin µDFN (derate 2.1mW/°C above +70°C) . .... 168mW

Operating Temperature Ranges:  
 MAX9502GE/ME .....-40°C to +85°C  
 MAX9502GA/MA.....-40°C to +125°C  
 Junction Temperature.....+150°C  
 Storage Temperature Range .....-65°C to +150°C  
 Lead Temperature (soldering, 10s) .....+300°C

Stresses beyond those listed under "Absolute Maximum Ratings" may cause permanent damage to the device. These are stress ratings only, and functional operation of the device at these or any other conditions beyond those indicated in the operational sections of the specifications is not implied. Exposure to absolute maximum rating conditions for extended periods may affect device reliability.

**DC Electrical Characteristics**

(V<sub>CC</sub> = SHDN = 3.0V, GND = 0V, no load, T<sub>A</sub> = T<sub>MIN</sub> to T<sub>MAX</sub>, unless otherwise noted. Typical values are at T<sub>A</sub> = +25°C, unless otherwise noted.) (Note 1)

PARAMETER	SYMBOL	CONDITIONS		MIN	TYP	MAX	UNITS
Supply Voltage Range	V <sub>CC</sub>	Guaranteed by PSRR		2.5		3.6	V
Quiescent Supply Current	I <sub>CC</sub>	V <sub>IN</sub> = 0V, 2.5V ≤ V <sub>CC</sub> ≤ 3.6V, SHDN = V <sub>CC</sub> , T <sub>A</sub> = -40°C to +85°C			5.3	9	mA
		V <sub>IN</sub> = 0V, 2.5V ≤ V <sub>CC</sub> ≤ 3.6V, SHDN = V <sub>CC</sub> , T <sub>A</sub> = -40°C to +125°C				11	
Shutdown Supply Current	I <sub>SHDN</sub>	V <sub>SHDN</sub> = 0V			0.01	1	µA
Input Voltage Range	V <sub>IN</sub>	Guaranteed by DC voltage gain (MAX9502G)	V <sub>CC</sub> = 2.5V	0		1.05	V
			V <sub>CC</sub> = 3.0V	0		1.2	
		Guaranteed by DC voltage gain (MAX9502M)	V <sub>CC</sub> = 2.5V	0		0.525	
			V <sub>CC</sub> = 3.0V	0		0.6	
Input Current	I <sub>IN</sub>	V <sub>IN</sub> = 0V			3.5	10	µA
Input Resistance	R <sub>IN</sub>	ΔV <sub>IN</sub> /ΔI <sub>IN</sub>			17		MΩ
DC Voltage Gain (Note 2)	A <sub>v</sub>	R <sub>L</sub> = 150Ω to GND, V <sub>CC</sub> = 2.5V to 3V	MAX9502G	5.5	6	6.5	dB
			MAX9502M	11.5	12	12.5	
Output Sync-Tip Level	V <sub>STIP</sub>	Measured at OUT, V <sub>IN</sub> = 0V, R <sub>L</sub> = 150Ω to GND			110	230	mV
Output Voltage Swing	V <sub>OUT</sub>	MAX9502G, R <sub>L</sub> = 150Ω to GND	V <sub>CC</sub> = 2.5V, 0 ≤ V <sub>IN</sub> ≤ 1.05V	1.97	2.1	2.23	V <sub>P-P</sub>
			V <sub>CC</sub> = 3.0V, 0 ≤ V <sub>IN</sub> ≤ 1.2V	2.26	2.4	2.54	
		MAX9502M, R <sub>L</sub> = 150Ω to GND	V <sub>CC</sub> = 2.5V, 0 ≤ V <sub>IN</sub> ≤ 0.525V	1.97	2.1	2.23	
			V <sub>CC</sub> = 3.0V, 0 ≤ V <sub>IN</sub> ≤ 0.6V	2.26	2.4	2.54	
Output Short-Circuit Current Threshold	I <sub>SC</sub>	Sourcing (Note 3)			95		mA
Output Resistance	R <sub>OUT</sub>				0.15		Ω
Shutdown Output Impedance	R <sub>OUT(OFF)</sub>	V <sub>SHDN</sub> = 0V			4		kΩ
DC Power-Supply Rejection Ratio	PSRR <sub>DC</sub>	V <sub>IN</sub> = 0V, 2.5V ≤ V <sub>CC</sub> ≤ 3.6V		50	90		dB
<b>LOGIC INPUTS (SHDN)</b>							
Logic-Low Level	V <sub>IL</sub>	T <sub>A</sub> = -40°C to +85°C				0.8	V
		T <sub>A</sub> = -40°C to +125°C				0.65	
Logic-High Level	V <sub>IH</sub>			2.0			V
Logic Input Current	I <sub>IL</sub>	SHDN = GND and V <sub>CC</sub>				1	µA

## AC Electrical Characteristics

( $V_{CC} = \overline{SHDN} = 3.0V$ ,  $GND = 0V$ ,  $R_L = 150\Omega$  to  $GND$ ,  $T_A = +25^\circ C$ , unless otherwise noted.) (Note 1)

PARAMETER	SYMBOL	CONDITIONS		MIN	TYP	MAX	UNITS
Passband Flatness		$V_{OUT} = 2V_{P-P}$ , $f = 100kHz$ to $5.5MHz$ , flatness is referred to $100kHz$		-1		+1	dB
Attenuation	$f_{dt}$	$V_{OUT} = 2V_{P-P}$ , attenuation is referred to $100kHz$	$f = 8MHz$		3		dB
			$f = 27MHz$	35	55		
Power-Supply Rejection Ratio	PSRR	$f = 100kHz$			56		dB
Output Impedance	$Z_{OUT}$	$V_{OUT} = 1.5V$ DC; $f = 5MHz$			2.5		$\Omega$
Differential Gain Error	DG	NTSC, $V_{OUT} = 2V_{P-P}$	MAX9502G		0.4		%
			MAX9502M		0.4		
Differential Phase Error	DP	NTSC, $V_{OUT} = 2V_{P-P}$	MAX9502G		0.4		degrees
			MAX9502M		0.4		
2T Pulse-to-Bar K Rating		2T = 250ns; bar time is 18 $\mu s$ ; the beginning 2.5% and the ending 2.5% of the bar time are ignored			0.2		K%
2T Pulse Response		2T = 250ns			0.3		K%
2T Bar Response		2T = 250ns; bar time is 18 $\mu s$ ; the beginning 2.5% and the ending 2.5% of the bar time are ignored			0.4		K%
Nonlinearity		5-step staircase			0.4		%
Line Time Distortion					0		%
Field Time Distortion					0		%
Group-Delay Variation	$\Delta(d\phi/d\omega)$	$f = 100kHz$ to $5.5MHz$	MAX9502G		30		ns
			MAX9502M		30		
Peak Signal to RMS Noise	SNR	$V_{OUT} = 2V_{P-P}$ , $100kHz$ to $5MHz$	MAX9502G		68		dB
			MAX9502M		65		
Enable Time	$t_{ON}$	$V_{\overline{SHDN}} = 3V$ , $V_{OUT}$ settled to within 1% of the final voltage	MAX9502G ( $V_{IN} = 1V$ )		800		ns
			MAX9502M ( $V_{IN} = 0.5V$ )		800		
Disable Time	$t_{OFF}$	$V_{\overline{SHDN}} = 0V$ , $V_{OUT}$ settled to below 1% of the output voltage	MAX9502G ( $V_{IN} = 1V$ )		220		ns
			MAX9502M ( $V_{IN} = 0.5V$ )		175		

**Note 1:** All devices are 100% production tested at  $T_A = +25^\circ C$ . Specifications over temperature limits are guaranteed by design.

**Note 2:** DC voltage gain ( $A_V$ ) is a two-point measurement in which the output voltage swing is divided by the input voltage swing.

**Note 3:** Short-circuit current is the trip current for the protection. During the protection, OUT is switched alternatively on and off.

Typical Operating Characteristics

V<sub>CC</sub> =  $\overline{\text{SHDN}}$  = 3.0V, GND = 0V, R<sub>L</sub> = 150Ω to GND.)

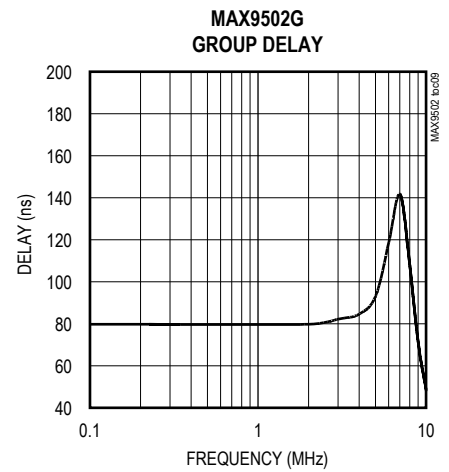
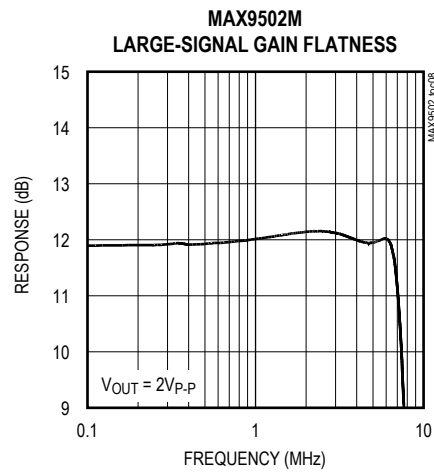
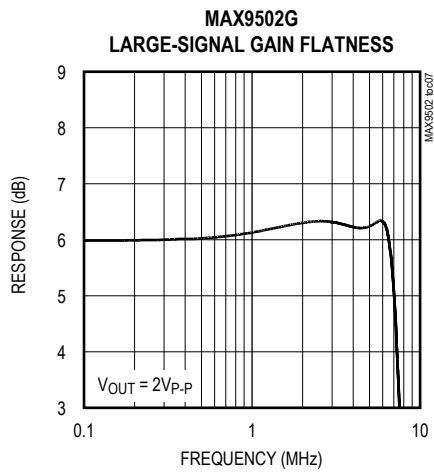
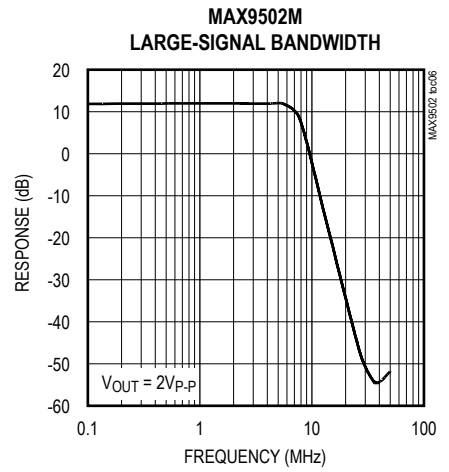
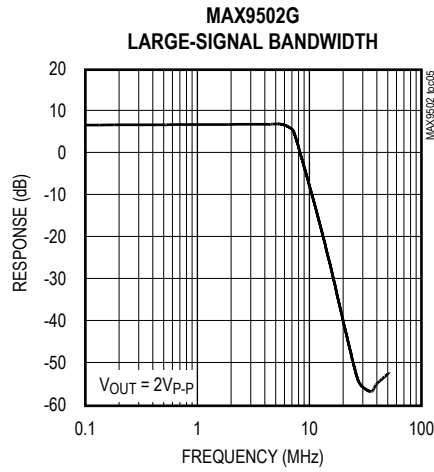
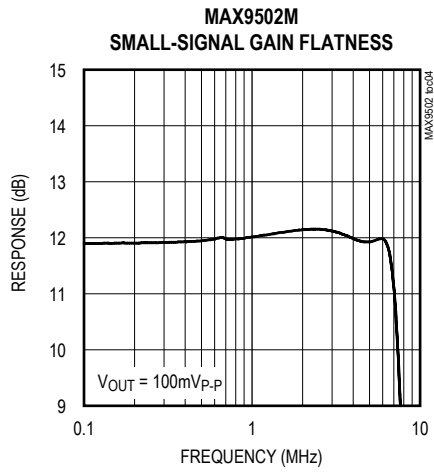
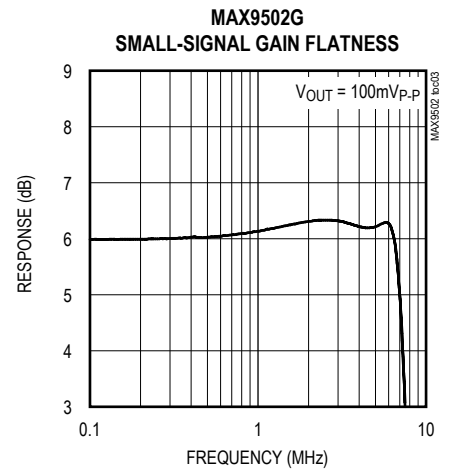
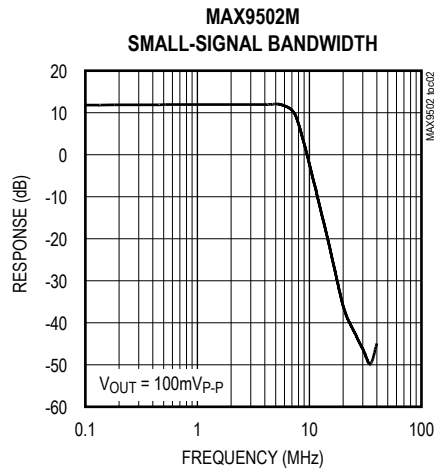
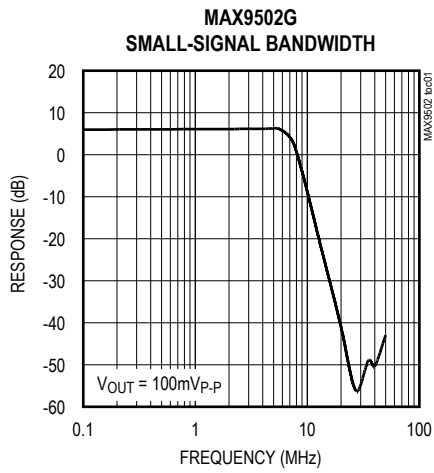

Typical Operating Characteristics (continued)

V<sub>CC</sub> =  $\overline{\text{SHDN}}$  = 3.0V, GND = 0V, R<sub>L</sub> = 150Ω to GND.)

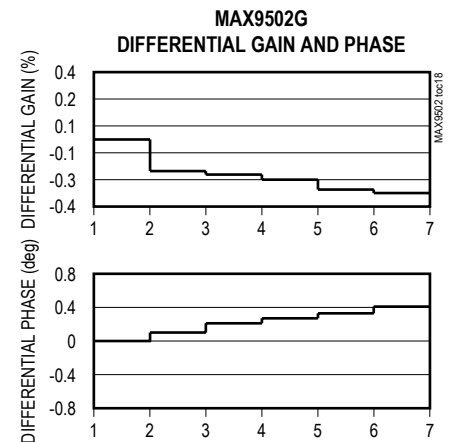
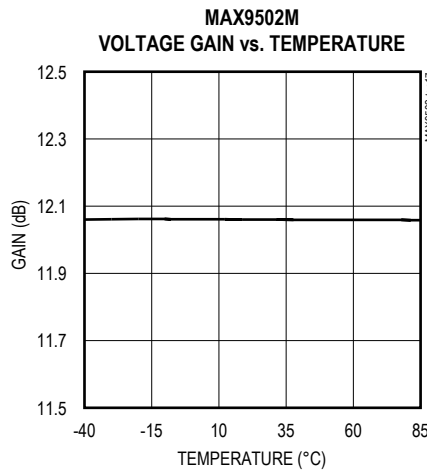
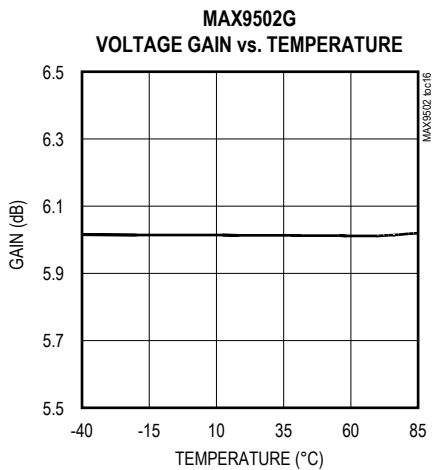
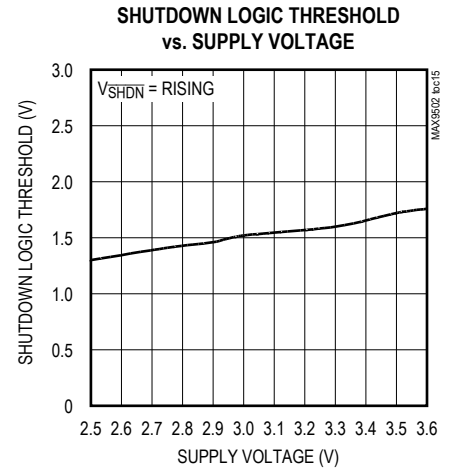
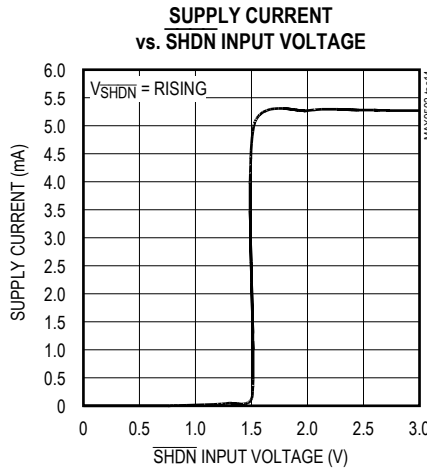
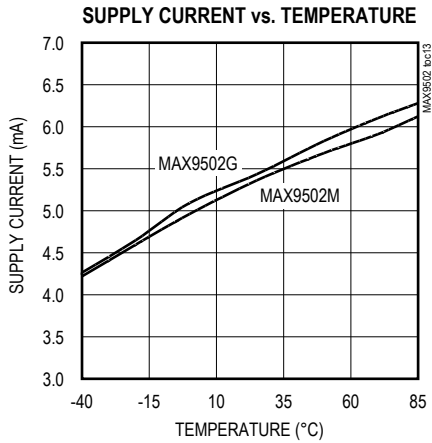
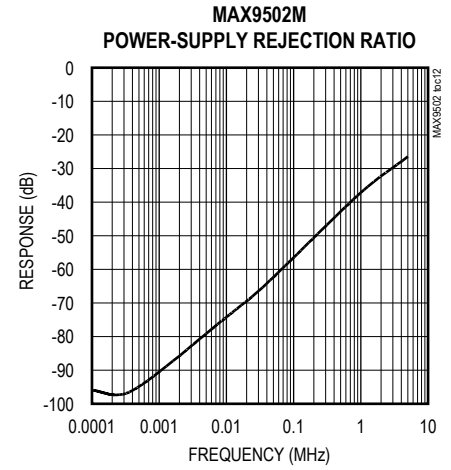
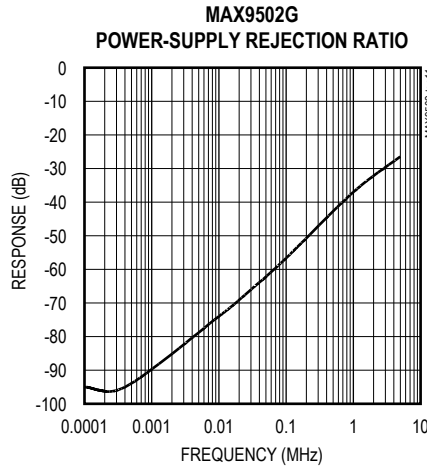
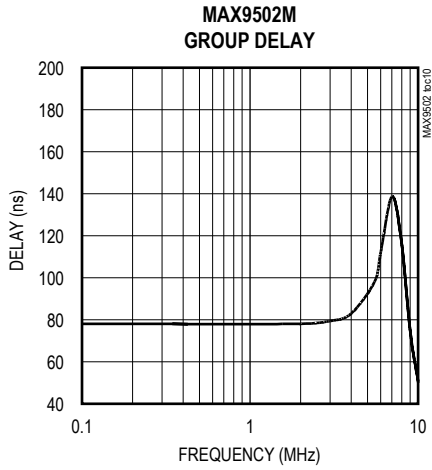

Typical Operating Characteristics (continued)

V<sub>CC</sub> =  $\overline{\text{SHDN}}$  = 3.0V, GND = 0V, R<sub>L</sub> = 150Ω to GND.)

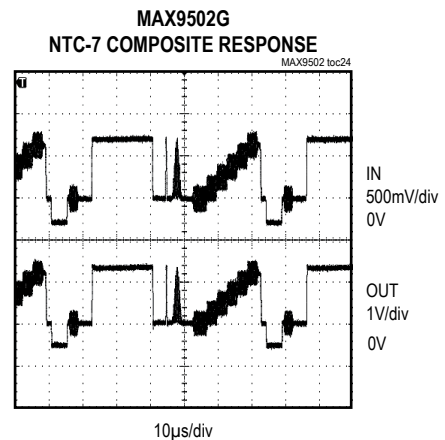
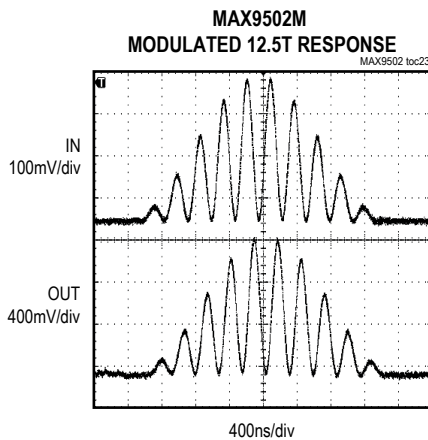
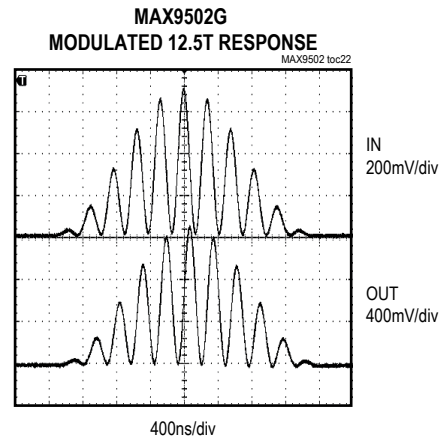
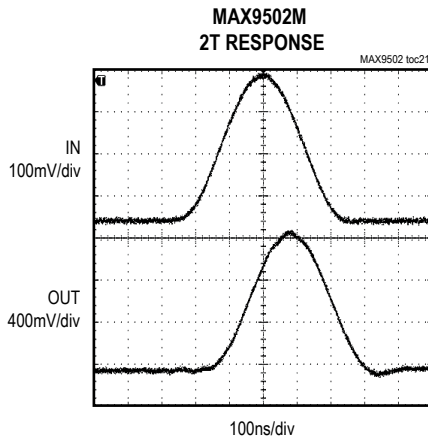
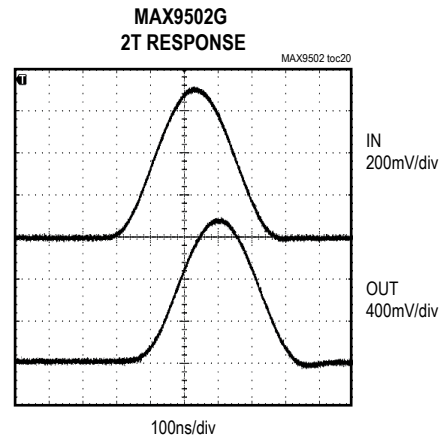
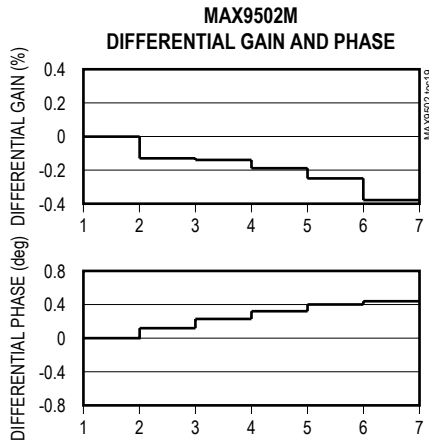

Typical Operating Characteristics (continued)

V<sub>CC</sub> =  $\overline{\text{SHDN}}$  = 3.0V, GND = 0V, R<sub>L</sub> = 150Ω to GND.)

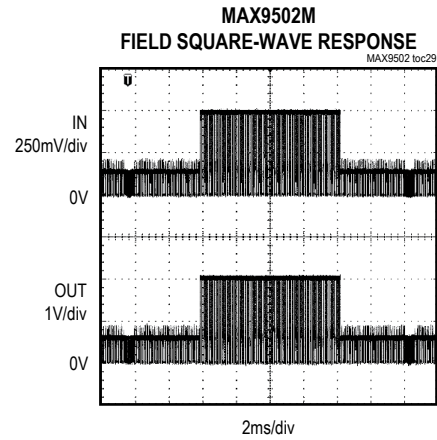
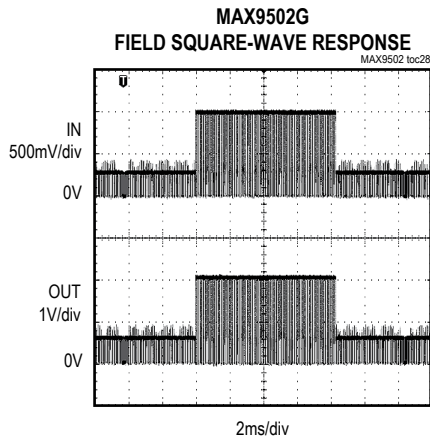
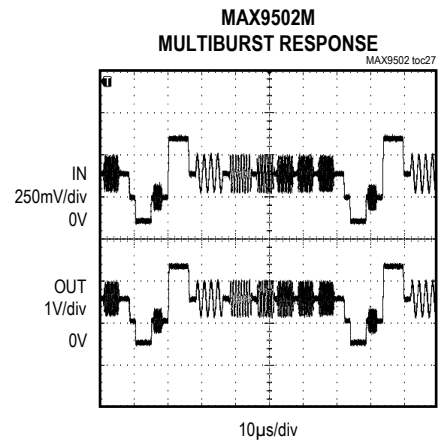
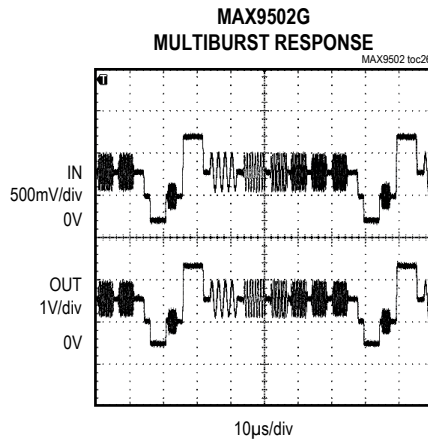
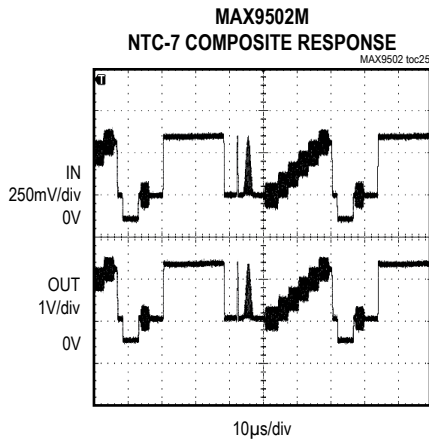

Pin Description

PIN		NAME	FUNCTION
µDFN	SC70		
1	1	IN	Video Input
2	2	GND	Ground
3	3	$\overline{\text{SHDN}}$	Active-Low Shutdown Input. Connect to GND to shutdown.
4	4	V <sub>CC</sub>	Positive Power Supply
5	—	N.C.	No Connection. Not internally connected.
6	5	OUT	Video Output

## Detailed Description

The MAX9502 filters and amplifies the video DAC output in applications such as digital still cameras and mobile phones. The MAX9502 consists of a lowpass filter and an output video buffer capable of driving a standard 150 $\Omega$  video load to ground. The MAX9502G output buffer provides a fixed gain of +6dB, while the MAX9502M output buffer provides a fixed gain of +12dB.

### Filter

The MAX9502 contains a 4th-order Chebyshev reconstruction filter. The Chebyshev-type response features a 0.4dB flat passband for NTSC and PAL signals. The stop-band offers 55dB (typ) of attenuation at 27MHz and above (see the *Typical Operating Characteristics*).

### Output Amplifier

The MAX9502G features a +6dB gain, while the MAX9502M features a +12dB gain. Operating from a 2.5V to 3.0V supply, the output amplifier is able to drive a 2V signal into a 150 $\Omega$  video load to ground. Operating from a 3.0V to 3.6V supply, the output amplifier is able to drive a 2.4V<sub>P-P</sub> signal into a 150 $\Omega$  video load to ground. The output is typically offset 110mV above ground to guarantee linear operation of the amplifier. The MAX9502 output only sources current; all loads should be connected to ground.

### Short-Circuit Protection

The MAX9502 typical application circuit includes a 75 $\Omega$  back-termination resistor that limits short-circuit currents for an external short applied at the video output. The MAX9502 features internal output short-circuit protection to prevent device damage in prototyping and applications where the amplifier output can be directly shorted.

Short-circuit protection activates if the output is short-circuited and the output current exceeds 95mA. During short-circuit protection, the output of the MAX9502 is shut off for 12 $\mu$ s and then turns on for 0.8 $\mu$ s. If the short is still present, the MAX9502 output shuts off again. Extended short circuits result in a pulsed output. The device resumes normal operation after the short is removed.

## Applications Information

### Input Considerations

The MAX9502 input is DC-coupled. When the supply voltage is between a 2.5V and 3V supply, the input voltage range extends from ground to 1.05V for the MAX9502G and from ground to 0.525V for the MAX9502M. When the supply voltage is between 3V and 3.6V, the input voltage range extends from ground to 1.2V for the MAX9502G and from ground to 0.6V for the MAX9502M. The MAX9502G accepts a composite video signal with a sync tip from 0 to 50mV and the MAX9502M accepts a composite video signal with a sync tip from 0 to 25mV. A typical current-output DAC that operates from a single supply usually creates a composite video signal with a sync tip very close to ground. Hence, the DAC output can be directly connected to the MAX9502 input. Keep the board trace as short as possible to minimize parasitic stray capacitance and prevent unintentional high-frequency attenuation.

### Output Considerations

The MAX9502 output must be DC-coupled. No AC-coupling capacitors are allowed. The MAX9502 connects directly to the video cable through a 75 $\Omega$  series backtermination resistor. The other end of the cable should be properly terminated with a 75 $\Omega$  resistor as well. Because of this configuration, the peak-to-peak amplitude as well as the DC level of the signal is divided by two. The MAX9502 output signal is level-shifted up so the sync tip is around 110mV.

### Power-Supply Bypassing and Layout Considerations

The MAX9502 operates from a single-supply voltage down to 2.5V, allowing for low-power consumption. Bypass  $V_{CC}$  to GND with a 0.1 $\mu$ F capacitor. Place all external components as close to the device as possible.

Ordering Information (continued)

PART	PIN-PACKAGE	TEMP RANGE	GAIN	TOP MARK
MAX9502MAALT+T	6 $\mu$ DFN-6	-40°C to +125°C	+12	LJ
MAX9502MAAXK+T	5 SC70-5	-40°C to +125°C	+12	ASP
MAX9502MELT+T	6 $\mu$ DFN-6	-40°C to +85°C	+12	AV
MAX9502MEXK+T	5 SC70-5	-40°C to +85°C	+12	ARW

+Denotes lead-free package.

Pin Configurations

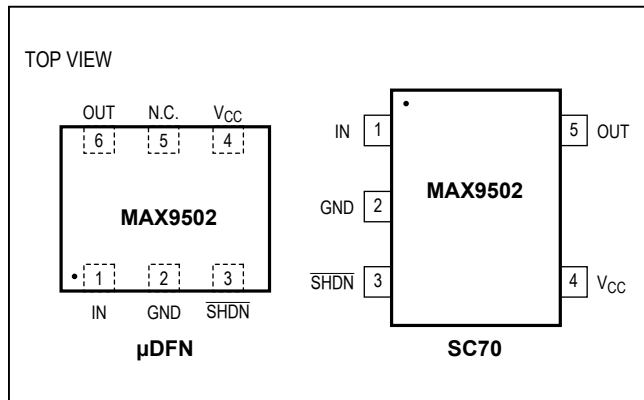

Chip Information

PROCESS: BiCMOS

Package Information

For the latest package outline information and land patterns (footprints), go to [www.maximintegrated.com/packages](http://www.maximintegrated.com/packages). Note that a "+", "#", or "-" in the package code indicates RoHS status only. Package drawings may show a different suffix character, but the drawing pertains to the package regardless of RoHS status.

PACKAGE TYPE	PACKAGE CODE	OUTLINE NO.	LAND PATTERN NO.
6 $\mu$ DFN	L611+1	<a href="#">21-0147</a>	<a href="#">90-0080</a>
5 SC70	X5+1	<a href="#">21-0076</a>	<a href="#">90-0188</a>

## Revision History

REVISION NUMBER	REVISION DATE	DESCRIPTION	PAGES CHANGED
2	5/14	Removed automotive reference in <i>Applications</i> section	1

For pricing, delivery, and ordering information, please contact Maxim Direct at 1-888-629-4642, or visit Maxim Integrated's website at [www.maximintegrated.com](http://www.maximintegrated.com).

*Maxim Integrated cannot assume responsibility for use of any circuitry other than circuitry entirely embodied in a Maxim Integrated product. No circuit patent licenses are implied. Maxim Integrated reserves the right to change the circuitry and specifications without notice at any time. The parametric values (min and max limits) shown in the Electrical Characteristics table are guaranteed. Other parametric values quoted in this data sheet are provided for guidance.*

## Looking for pricing, stock, or lifecycle information?

Click below to explore more details on WIN SOURCE:

- ⊖ [View MAX9502GAAXK+T on WIN SOURCE](#)
- ⊖ [Maxim Integrated Information](#)

## Optimize Your Supply Chain with WIN SOURCE Solutions

- ✓ Global Sourcing Solution
- ✓ Obsolete Management
- ✓ Cost Control Management
- ✓ Shortage Management
- ✓ Alternative Solution
- ✓ Excess Inventory Management