



**THE DATASHEET OF
ISL28227FUBZ-T7A**



ISL28127, ISL28227, ISL28227SEH

Precision Single and Dual Low Noise Operational Amplifiers

FN6633
Rev 8.00
April 1, 2016

The [ISL28127](#), [ISL28227](#) and [ISL28227SEH](#) are very high precision amplifiers featuring very low noise, low offset voltage, low input bias current and low temperature drift making them the ideal choice for applications requiring both high DC accuracy and AC performance. The combination of precision, low noise and small footprint provides the user with outstanding value and flexibility relative to similar competitive parts.

Applications for these amplifiers include precision active filters, medical and analytical instrumentation, precision power supply controls and industrial controls.

The ISL28127 single and ISL28227 dual are available in 8 Ld SOIC, TDFN and MSOP packages. All devices are offered in standard pin configurations and operate over the extended temperature range to -40 °C to +125 °C.

The ISL28227SEH is available in a 10 Ld hermetic ceramic Flatpack package. The device is offered in an industry standard pin configuration and operates over the extended temperature range from -55 °C to +125 °C.

Related Literature

- [AN1508](#), ISL281x7SOICEVAL1Z Evaluation Board User's Guide
- [AN1509](#), ISL282x7SOICEVAL1Z Evaluation Board User's Guide
- [AN1556](#), Building an Accurate SPICE Model for Low Noise, Low Power Precision Amplifiers
- [AN1690](#), Electronics Meets the Challenges of Patient Monitors

Features

- Low input offset voltage $\pm 70\mu\text{V}$, max
ISL28227SEH $\pm 75\mu\text{V}$, max
- Superb offset voltage TC $0.5\mu\text{V}/^\circ\text{C}$, max
ISL28227SEH $1\mu\text{V}/^\circ\text{C}$, max
- Wide supply range 4.5V to 40V
ISL28227SEH 4.5V to 36V
- Very low voltage noise $2.5\text{nV}/\text{Hz}$
- Input bias current $\pm 10\text{nA}$, max
- Gain-bandwidth product 10MHz Unity gain stable
- No phase reversal
- Operating temperature range -40°C to $+125^\circ\text{C}$
ISL28227SEH -55°C to $+125^\circ\text{C}$

Applications

- Precision instruments
- Medical instrumentation
- Industrial controls
- Active filter blocks
- Data acquisition
- Power supply control

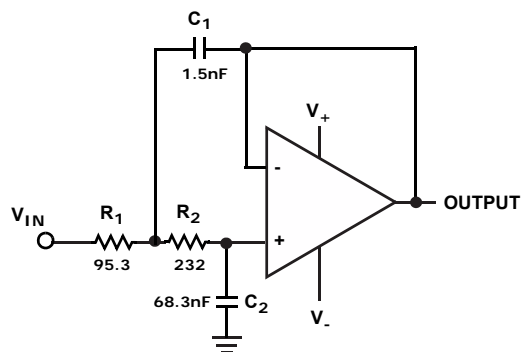

Sallen-Key Low Pass Filter (1MHz)

FIGURE 1. TYPICAL APPLICATION

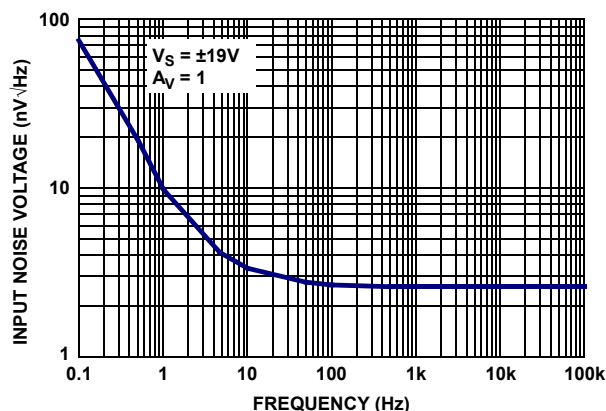

FIGURE 2. INPUT NOISE VOLTAGE SPECTRAL DENSITY

Table of Contents

Related Literature	1
Ordering Information	3
Pin Configurations	4
Pin Descriptions	4
Absolute Maximum Ratings	6
Thermal Information	6
Recommended Operating Conditions	6
Electrical Specifications ISL28127, ISL28227 ($V_S \pm 15V$)	6
Electrical Specifications ISL28127, ISL28227 ($V_S \pm 5V$)	8
Electrical Specifications ISL28227SEH ($V_S \pm 15V$)	10
Electrical Specifications ISL28227SEH ($V_S \pm 5V$)	11
Typical Performance Curves	13
Applications Information	19
Functional Description	19
Operating Voltage Range	19
Input ESD Diode Protection	19
Output Current Limiting	19
Output Phase Reversal	19
Unused Channels	19
Power Dissipation	19
ISL28127, ISL28227 SPICE Model	20
Characterization vs Simulation Results	23
Revision History	26
About Intersil	29
Package Outline Drawing	30
M8.15E	30
L8.3x3K	31
M8.118B	32
K10.A	33

Ordering Information

PART NUMBER	PART MARKING	V _{OS} (MAX) (μ V)	PACKAGE (RoHS Compliant)	PKG. DWG. #
ISL28127FBZ (No longer available, recommended replacement: ISL28127FRTZ-T13) (Notes 1, 4, 6)	28127 FBZ	70	8 Ld SOIC	M8.15E
ISL28127FRTBZ (No longer available, recommended replacement: ISL28127FRTZ-T13) (Notes 1, 4, 6)	8127	75 (B Grade)	8 Ld TDFN	L8.3x3K
ISL28127FRTZ (Notes 1, 4, 6)	-C 8127	150 (C Grade)	8 Ld TDFN	L8.3x3K
ISL28127FUBZ (No longer available, recommended replacement: ISL28127FRTZ-T13) (Notes 1, 4, 6)	8127Z	70 (B Grade)	8 Ld MSOP	M8.118B
ISL28127FUZ (No longer available, recommended replacement: ISL28127FRTZ-T13) (Notes 1, 4, 6)	8127Z -C	150 (C Grade)	8 Ld MSOP	M8.118B
ISL28227FBZ (Notes 2, 4, 6)	28227 FBZ	75	8 Ld SOIC	M8.15E
ISL28227FRTBZ (Notes 2, 4, 6)	8227	75 (B Grade)	8 Ld TDFN	L8.3x3K
ISL28227FRTZ (Notes 1, 4, 6)	-C 8227	150 (C Grade)	8 Ld TDFN	L8.3x3K
ISL28227FUBZ (Notes 3, 4, 6)	8227Z	75 (B Grade)	8 Ld MSOP	M8.118B
ISL28227FUZ (Notes 3, 4, 6)	8227Z -C	150 (C Grade)	8 Ld MSOP	M8.118B
ISL28227SEHMF (Note 5)	ISL28227SEHMF	75 (B Grade)	10 Ld FLATPACK	K10.A
ISL28227SEHF/PROTO (Note 5)	ISL28227 SEHF/PROTO	75 (B Grade)	10 Ld FLATPACK	K10.A
ISL28227SEHMX (Note 5)		75 (B Grade)	DIE	
ISL28227SEHX/SAMPLE (Note 5)		75 (B Grade)	DIE	
ISL28127SOICEVAL1Z	Evaluation Board			
ISL28127MSOPEVAL1Z	Evaluation Board			
ISL28227SOICEVAL2Z	Evaluation Board			
ISL70227MHEVAL1Z	Evaluation Board			

1. Add "-T13" suffix for 6k unit, "-T7" suffix for 1k, "-T7A" suffix for 250 unit Tape and Reel options. Please refer to [TB347](#) for details on reel specifications.
2. Add "-T13" suffix for 2.5k unit, "-T7" suffix for 1k, "-T7A" suffix for 250 unit Tape and Reel options. Please refer to [TB347](#) for details on reel specifications.
3. Add "-T13" suffix for 2.5k unit, "-T7" suffix for 1.5k, "-T7A" suffix for 250 unit Tape and Reel options. Please refer to [TB347](#) for details on reel specifications.
4. These Intersil Pb-free plastic packaged products employ special Pb-free material sets, molding compounds/die attach materials, and 100% matte tin plate plus anneal (e3 termination finish, which is RoHS compliant and compatible with both SnPb and Pb-free soldering operations). Intersil Pb-free products are MSL classified at Pb-free peak reflow temperatures that meet or exceed the Pb-free requirements of IPC/JEDEC J STD-020.
5. These Intersil Pb-free Hermetic packaged products employ 100% Au plate - e4 termination finish, which is RoHS compliant and compatible with both SnPb and Pb-free soldering operations.
6. For Moisture Sensitivity Level (MSL), please see device information page for [ISL28127](#), [ISL28227](#). For more information on MSL please see techbrief [TB363](#).

TABLE 1. KEY DIFFERENCES BETWEEN FAMILY OF PARTS

PART NUMBER	NUMBER OF DEVICES	OPERATING TEMPERATURE RANGE
ISL28127	1	-40 °C to +125 °C
ISL28227	2	-40 °C to +125 °C
ISL28227SEH	2	-55 °C to +125 °C

Pin Configurations

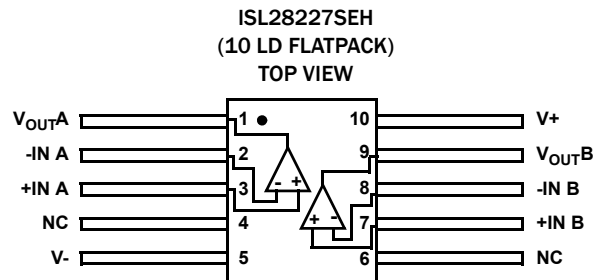
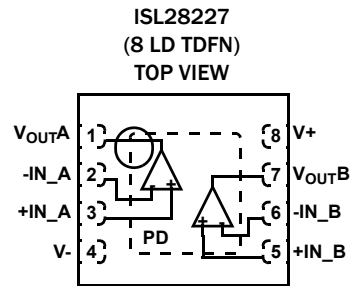
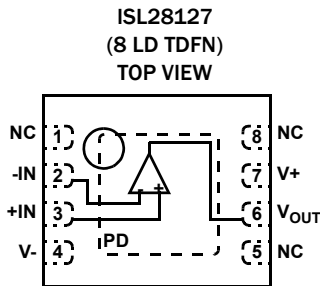
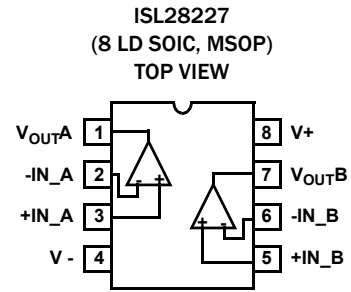
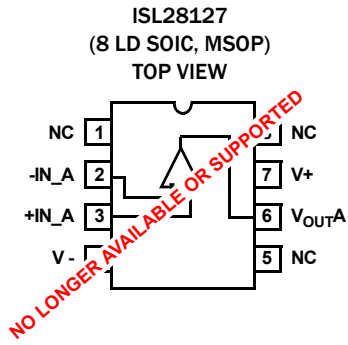

Pin Descriptions

ISL28127 (8 Ld SOIC, 8 Ld MSOP) (NO LONGER AVAILABLE)	ISL28127 (8 Ld TDFN)	ISL28227 (8 Ld SOIC, 8 Ld MSOP)	ISL28227 (8 Ld TDFN)	ISL28227SEH (10 Ld Flatpack)	PIN NAME	EQUIVALENT CIRCUIT	DESCRIPTION
	3				+IN	Circuit 1	Amplifier noninverting input
3		3	3	3	+IN_A	Circuit 1	Amplifier A noninverting input
4	4	4	4	5	V-	Circuit 3	Negative power supply
		5	5	7	+IN_B	Circuit 1	Amplifier B noninverting input
	2				-IN	Circuit 1	Amplifier inverting input
		6	6	8	-IN_B	Circuit 1	Amplifier B inverting input

Pin Descriptions (Continued)

ISL28127 (8 Ld SOIC, 8 Ld MSOP) (NO LONGER AVAILABLE)	ISL28127 (8 Ld TDFN)	ISL28227 (8 Ld SOIC, 8 Ld MSOP)	ISL28227 (8 Ld TDFN)	ISL28227SEH (10 Ld Flatpack)	PIN NAME	EQUIVALENT CIRCUIT	DESCRIPTION
	6				V _{OUT}	Circuit 2	Amplifier output
		7	7	9	V _{OUT} B	Circuit 2	Amplifier B output
7	7	8	8	10	V+	Circuit 3	Positive power supply
6		1	1	1	V _{OUT} A	Circuit 2	Amplifier A output
2		2	2	2	-IN_A	Circuit 1	Amplifier A inverting input
1, 5, 8	1, 5, 8			4, 6	NC	-	Not Connected - This pin is not electrically connected internally.
	PD				PD	-	Thermal Pad. Pad should be connected to lowest potential source in the circuit.

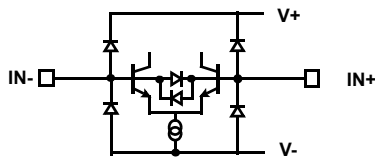

CIRCUIT 1

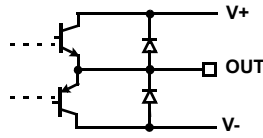

CIRCUIT 2

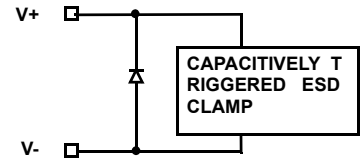

CIRCUIT 3

Absolute Maximum Ratings

Maximum Supply Voltage	2V
Maximum Supply Voltage ISL28227SEH (Note 12)	36V
Maximum Differential Input Current	20mA
Maximum Differential Input Voltage	0.5V
Min/Max Input Voltage	V-- 0.5V to V+ + 0.5V
Max/Min Input Current for	
Input Voltage >V+ or <V-	±20mA
Output Short-Circuit Duration	
(1 Output at a Time)	Indefinite
ESD Tolerance ISL28127, ISL28227	
Human Body Model (Tested per JESD22-A114F)	
ISL28127	4.5kV
ISL28227	6.0kV
Machine Model (Tested per EIA/JESD22-A115-A)	500V
Charged Device Model (Tested per JESD22-C101D)	1.5kV
ESD Tolerance ISL28227SEH	
Human Body Model (Tested per JESD22-A114F)	2kV
Machine Model (Tested per EIA/JESD22-A115-A)	300V
Charged Device Model (Tested per JESD22-C101D)	750V

Thermal Information

Thermal Resistance (Typical)	θ_{JA} (°C/W)	θ_{JC} (°C/W)
8 Ld SOIC (Notes 8, 11)		
ISL28127	120	60
ISL28227	110	55
8 Ld TDFN (Notes 7, 10)		
ISL28127	48	7
ISL28227	47	6
8 Ld MSOP (Notes 8, 11)		
ISL28127	155	50
ISL28227	150	45
10 Ld Ceramic Flatpack (Notes 9, 10)	130	20
Pb-Free Reflow Profile (None-Hermetic Packages Only)	see TB493	
Storage Temperature Range	-65°C to +150°C	

Recommended Operating Conditions

Ambient Operating Temperature Range	
ISL28127, ISL28227	-40°C to +125°C
ISL28227SEH	-55°C to +125°C
Maximum Operating Junction Temperature	+150°C

CAUTION: Do not operate at or near the maximum ratings listed for extended periods of time. Exposure to such conditions may adversely impact product reliability and result in failures not covered by warranty.

NOTES:

7. θ_{JA} is measured in free air with the component mounted on a high effective thermal conductivity test board with "direct attach" features. See Tech Brief TB379.
8. θ_{JA} is measured with the component mounted on a high effective thermal conductivity test board in free air. See Tech Brief TB379 for details.
9. θ_{JA} is measured with the component mounted on a low effective thermal conductivity test board in free air. See Tech Brief TB379 for details.
10. For θ_{JC} , the "case temp" location is the center of the package underside.
11. For θ_{JC} , the "case temp" location is taken at the package top center.
12. No destructive single-event effects at effective LET of 86.4MeV•cm²/mg up to a supply of ±18V. Reference manufacturers SEE report.

Electrical Specifications ISL28127, ISL28227 (V_S ±15V) V_{CM} = 0, V_O = 0V, R_L = Open, T_A = +25°C, unless otherwise noted. **Boldface limits apply across the operating temperature range, -40°C to +125°C.**

PARAMETER	DESCRIPTION	TEST CONDITIONS	MIN (Note 13)	TYP	MAX (Note 13)	UNIT
V _{OS}	Offset Voltage; SOIC Package	ISL28127	-70	10	70	μV
			-120	-	120	μV
		ISL28227	-75	10	75	μV
			-150	-	150	μV
	Offset Voltage; MSOP Grade B Package	ISL28127	-70	-10	70	μV
			-150	-	150	μV
	Offset Voltage; TDFN Grade B Package	ISL28127	-75	-10	75	μV
			-160	-	160	μV
	Offset Voltage; MSOP, TDFN Grade B Package	ISL28227	-75	-10	75	μV
			-150	-	150	μV
	Offset Voltage; MSOP, TDFN Grade C Package	ISL28127 ISL28227	-150	-10	150	μV
			-250	-	250	μV

Electrical Specifications ISL28127, ISL28227 ($V_S \pm 15V$) $V_{CM} = 0$, $V_O = 0V$, $R_L = \text{Open}$, $T_A = +25^\circ\text{C}$, unless otherwise noted. **Boldface limits apply across the operating temperature range, -40°C to $+125^\circ\text{C}$.** (Continued)

PARAMETER	DESCRIPTION	TEST CONDITIONS	MIN (Note 13)	TYP	MAX (Note 13)	UNIT
TCV _{OS}	Offset Voltage Drift; SOIC Package	ISL28127	-0.5	0.1	0.5	$\mu\text{V}/^\circ\text{C}$
		ISL28227	-0.75	0.10	0.75	$\mu\text{V}/^\circ\text{C}$
	Offset Voltage Drift; MSOP, Grade B	ISL28127	-0.80	0.10	0.80	$\mu\text{V}/^\circ\text{C}$
		ISL28127	-0.90	0.10	0.90	$\mu\text{V}/^\circ\text{C}$
	Offset Voltage Drift; MSOP, TDFN, Grade B	ISL28127	-0.90	0.10	0.90	$\mu\text{V}/^\circ\text{C}$
		ISL28227	-0.75	0.10	0.75	$\mu\text{V}/^\circ\text{C}$
I _{OS}	Input Offset Current	ISL28127	-10	1	10	nA
		ISL28227	-12	-	12	nA
I _B	Input Bias Current	ISL28127	-10	1	10	nA
		ISL28227	-12	-	12	nA
V _{CM}	Input Voltage Range	Guaranteed by CMRR	-13	-	13	V
			-12	-	12	V
CMRR	Common-Mode Rejection Ratio	V _{CM} = -13V to +13V	115	120	-	dB
		V _{CM} = -12V to +12V	115	-	-	dB
PSRR	Power Supply Rejection Ratio ISL28127	V _S = $\pm 2.25V$ to $\pm 20V$	115	125	-	dB
		V _S = $\pm 3V$ to $\pm 20V$	115	-	-	dB
	Power Supply Rejection Ratio ISL28227	V _S = $\pm 2.25V$ to $\pm 20V$	110	117	-	dB
		V _S = $\pm 3V$ to $\pm 20V$	110	-	-	dB
A _{VOL}	Open-Loop Gain	V _O = -13V to +13V R _L = 10k Ω to ground	1000	1500	-	V/mV
V _{OH}	Output Voltage High	R _L = 10k Ω to ground	13.50	13.65	-	V
			13.2	-	-	V
		R _L = 2k Ω to ground	13.4	13.5	-	V
			13.1	-	-	V
V _{OL}	Output Voltage Low	R _L = 10k Ω to ground	-	-13.65	-13.50	V
			-	-	-13.2	V
		R _L = 2k Ω to ground	-	-13.5	-13.4	V
			-	-	-13.1	V
I _S	Supply Current/Amplifier	ISL28127	-	2.2	2.8	mA
		ISL28227	-	-	3.7	mA
I _{SC}	Short-Circuit	R _L = 0 Ω to ground	-	± 45	-	mA
V _{SUPPLY}	Supply Voltage Range	Guaranteed by PSRR	± 2.25	-	± 20	V

Electrical Specifications ISL28127, ISL28227 ($V_S \pm 15V$) $V_{CM} = 0, V_O = 0V, R_L = \text{Open}, T_A = +25^\circ\text{C}$, unless otherwise noted. **Boldface limits apply across the operating temperature range, -40°C to $+125^\circ\text{C}$.** (Continued)

PARAMETER	DESCRIPTION	TEST CONDITIONS	MIN (Note 13)	TYP	MAX (Note 13)	UNIT
AC SPECIFICATIONS						
GBW	Gain Bandwidth Product		-	10	-	MHz
e_{np-p}	Voltage Noise	0.1Hz to 10Hz	-	85	-	nV _{P-P}
e_n	Voltage Noise Density	f = 10Hz	-	3	-	nV/ $\sqrt{\text{Hz}}$
		f = 100Hz	-	2.8	-	nV/ $\sqrt{\text{Hz}}$
		f = 1kHz	-	2.5	-	nV/ $\sqrt{\text{Hz}}$
		f = 10kHz	-	2.5	-	nV/ $\sqrt{\text{Hz}}$
i_n	Current Noise Density	f = 10kHz	-	0.4	-	pA/ $\sqrt{\text{Hz}}$
THD + N	Total Harmonic Distortion + Noise	1kHz, G = 1, $V_O = 3.5V_{RMS}$, $R_L = 2k\Omega$	-	0.00022	-	%
TRANSIENT RESPONSE						
SR	Slew Rate	$A_V = 10, R_L = 2k\Omega, V_O = 4V_{P-P}$	-	± 3.6	-	V/ μs
t_r, t_f , Small Signal	Rise Time 10% to 90% of V_{OUT}	$A_V = -1, V_{OUT} = 100mV_{P-P}$, $R_f = R_g = 2k\Omega, R_L = 2k\Omega$ to V_{CM}	-	36	-	ns
	Fall Time 90% to 10% of V_{OUT}	$A_V = -1, V_{OUT} = 100mV_{P-P}$, $R_f = R_g = 2k\Omega, R_L = 2k\Omega$ to V_{CM}	-	38	-	ns
t_s	Settling Time to 0.1% 10V Step; 10% to V_{OUT}	$A_V = -1, V_{OUT} = 10V_{P-P}$, $R_g = R_f = 10k, R_L = 2k\Omega$ to V_{CM}	-	3.4	-	μs
	Settling Time to 0.01% 10V Step; 10% to V_{OUT}	$A_V = -1, V_{OUT} = 10V_{P-P}$, $R_L = 2k\Omega$ to V_{CM}	-	3.8	-	μs
t_{OL}	Output Overload Recovery Time	$A_V = 100, V_{IN} = 0.2V$, $R_L = 2k\Omega$ to V_{CM}	-	1.7	-	μs

Electrical Specifications ISL28127, ISL28227 ($V_S \pm 5V$) $V_{CM} = 0, V_O = 0V, T_A = +25^\circ\text{C}$, unless otherwise noted. **Boldface limits apply across the operating temperature range, -40°C to $+125^\circ\text{C}$.**

PARAMETER	DESCRIPTION	TEST CONDITIONS	MIN (Note 13)	TYP	MAX (Note 13)	UNIT
V_{OS}	Offset Voltage; SOIC Package	ISL28127	-70	10	70	μV
			-120	-	120	μV
		ISL28227	-75	10	75	μV
			-150	-	150	μV
	Offset Voltage; MSOP Grade B Package	ISL28127	-70	-10	70	μV
			-150	-	150	μV
	Offset Voltage; TDFN Grade B Package	ISL28127	-75	-10	75	μV
			-160	-	160	μV
	Offset Voltage; MSOP, TDFN Grade B Package	ISL28227	-75	-10	75	μV
			-150	-	150	μV
	Offset Voltage; MSOP, TDFN Grade C Package	ISL28127 ISL28227	-150	-10	150	μV
			-250	-	250	μV

Electrical Specifications ISL28127, ISL28227 ($V_S \pm 5V$) $V_{CM} = 0, V_O = 0V, T_A = +25^\circ C$, unless otherwise noted.
Boldface limits apply across the operating temperature range, $-40^\circ C$ to $+125^\circ C$. (Continued)

PARAMETER	DESCRIPTION	TEST CONDITIONS	MIN (Note 13)	TYP	MAX (Note 13)	UNIT
TCV _{OS}	Offset Voltage Drift; SOIC Package	ISL28127	-0.5	0.1	0.5	$\mu V/^\circ C$
		ISL28227	-0.75	0.1	0.75	$\mu V/^\circ C$
	Offset Voltage Drift; MSOP, Grade B	ISL28127	-0.80	0.1	0.80	$\mu V/^\circ C$
		ISL28127	-0.90	0.1	0.90	$\mu V/^\circ C$
	Offset Voltage Drift; MSOP, TDFN, Grade B	ISL28227	-0.75	0.1	0.75	$\mu V/^\circ C$
		ISL28127 ISL28227	-1	0.1	1	$\mu V/^\circ C$
I _{OS}	Input Offset Current		-10	1	10	nA
			-12	-	12	nA
I _B	Input Bias Current		10	1	10	nA
			-12	-	12	nA
V _{CM}	Common-Mode Input Voltage Range	Guaranteed by CMRR	-3	-	3	V
			-2	-	2	V
CMRR	Common-Mode Rejection Ratio	V _{CM} = -3V to +3V	115	120	-	dB
		V _{CM} = -2V to +2V	115	-	-	dB
PSRR	Power Supply Rejection Ratio	V _S = $\pm 2.25V$ to $\pm 5V$	115	125	-	dB
		V _S = $\pm 3V$ to $\pm 5V$	115	-	-	dB
A _{VOL}	Open-Loop Gain	V _O = -3V to +3V R _L = 10k Ω to ground	1000	1500	-	V/mV
V _{OH}	Output Voltage High	R _L = 10k Ω to ground	3.50	3.65	-	V
			3.2	-	-	V
		R _L = 2k Ω to ground	3.4	3.5	-	
			3.1	-	-	V
V _{OL}	Output Voltage Low	R _L = 10k Ω to ground	-	-3.65	-3.50	V
			-	-	-3.2	V
		R _L = 2k Ω to ground	-	-3.5	-3.4	
			-	-	-3.1	V
I _S	Supply Current/Amplifier		-	2.2	2.8	mA
			-	-	3.7	mA
I _{SC}	Short-Circuit		-	± 45	-	mA
AC SPECIFICATIONS						
GBW	Gain Bandwidth Product		-	10	-	MHz
THD + N	Total Harmonic Distortion + Noise	1kHz, G = 1, V _O = 2.5V _{RMS} , R _L = 2k Ω	-	0.0034	-	%
TRANSIENT RESPONSE						
SR	Slew Rate	A _V = 10, R _L = 2k Ω	-	± 3.6	-	V/ μ s

Electrical Specifications ISL28127, ISL28227 ($V_S \pm 5V$) $V_{CM} = 0, V_O = 0V, T_A = +25^\circ C$, unless otherwise noted.
Boldface limits apply across the operating temperature range, $-40^\circ C$ to $+125^\circ C$. (Continued)

PARAMETER	DESCRIPTION	TEST CONDITIONS	MIN (Note 13)	TYP	MAX (Note 13)	UNIT
t_r, t_f , Small Signal	Rise Time 10% to 90% of V_{OUT}	$A_V = -1, V_{OUT} = 100mV_{P-P}$ $R_f = R_g = 2k\Omega, R_L = 2k\Omega$ to V_{CM}	-	36	-	ns
	Fall Time 90% to 10% of V_{OUT}	$A_V = -1, V_{OUT} = 100mV_{P-P}$ $R_f = R_g = 2k\Omega, R_L = 2k\Omega$ to V_{CM}	-	38	-	ns
t_s	Settling Time to 0.1%	$A_V = -1, V_{OUT} = 4V_{P-P}$ $R_f = R_g = 2k\Omega, R_L = 2k\Omega$ to V_{CM}	-	1.6	-	μs
	Settling Time to 0.01%	$A_V = -1, V_{OUT} = 4V_{P-P}$ $R_f = R_g = 2k\Omega, R_L = 2k\Omega$ to V_{CM}	-	4.2	-	μs

Electrical Specifications ISL28227SEH ($V_S \pm 15V$) $V_{CM} = 0, V_O = 0V, R_L = \text{Open}, T_A = +25^\circ C$, unless otherwise noted.
Boldface limits apply across the $-55^\circ C$ to $+125^\circ C$ operating temperature range. The limits also define room temperature post-irradiation performance following ^{60}Co irradiation at 0.01rad(SI)/s to a total dose of 50krad(SI) wafer-by-wafer acceptance.

PARAMETER	DESCRIPTION	TEST CONDITIONS	MIN (Note 13)	TYP	MAX (Note 13)	UNIT
V_{OS}	Offset Voltage		-75	-10	75	μV
			-100	-	100	μV
TCV_{OS}	Offset Voltage Drift		-1	0.1	1	$\mu V/^\circ C$
I_{OS}	Input Offset Current	$T_A = +25^\circ C$	-10	1	10	nA
		$T_A = -55^\circ C, +125^\circ C$	-12	-	12	nA
		$T_A = +25^\circ C$, post radiation	-25	-	25	nA
I_B	Input Bias Current	$T_A = +25^\circ C$	-10	1	10	nA
		$T_A = -55^\circ C, +125^\circ C$	-12	-	12	nA
		$T_A = +25^\circ C$, post radiation	-25	-	25	nA
V_{CM}	Input Voltage Range	Guaranteed by CMRR	-13	-	13	V
			-12	-	12	V
CMRR	Common-Mode Rejection Ratio	$V_{CM} = -13V$ to $+13V$	115	120	-	dB
		$V_{CM} = -12V$ to $+12V$	115	-	-	dB
PSRR	Power Supply Rejection Ratio	$V_S = \pm 2.25V$ to $\pm 5V$	110	117	-	dB
		$V_S = \pm 3V$ to $\pm 15V$	110	-	-	dB
A_{VOL}	Open-Loop Gain	$V_O = -13V$ to $+13V$ $R_L = 10k\Omega$ to ground	1000	1500	-	V/mV
V_{OH}	Output Voltage High	$R_L = 10k\Omega$ to ground	13.5	13.65	-	V
			13.2	-	-	V
		$R_L = 2k\Omega$ to ground	13.4	13.5	-	V
			13.1	-	-	V
V_{OL}	Output Voltage Low	$R_L = 10k\Omega$ to ground	-	-13.65	-13.5	V
			-	-	-13.2	V
		$R_L = 2k\Omega$ to ground	-	-13.5	-13.4	V
			-	-	-13.1	V
I_S	Supply Current/Amplifier		-	2.2	2.8	mA
			-	-	3.7	mA
I_{SC}	Short-Circuit	$R_L = 0\Omega$ to ground	-	± 45	-	mA

Electrical Specifications ISL28227SEH ($V_S \pm 15V$) $V_{CM} = 0$, $V_O = 0V$, $R_L = \text{Open}$, $T_A = +25^\circ\text{C}$, unless otherwise noted. **Boldface limits apply across the -55°C to $+125^\circ\text{C}$ operating temperature range. The limits also define room temperature post-irradiation performance following ^{60}Co irradiation at 0.01rad(Si)/s to a total dose of 50krad(Si) wafer-by-wafer acceptance. (Continued)**

PARAMETER	DESCRIPTION	TEST CONDITIONS	MIN (Note 13)	TYP	MAX (Note 13)	UNIT
V_{SUPPLY}	Supply Voltage Range	Guaranteed by PSRR	± 2.25	-	± 15	V
AC SPECIFICATIONS						
GBW	Gain Bandwidth Product		-	10	-	MHz
$e_{\text{np-p}}$	Voltage Noise	0.1Hz to 10Hz	-	85	-	nV _{P-P}
e_n	Voltage Noise Density	$f = 10\text{Hz}$	-	3	-	nV/ $\sqrt{\text{Hz}}$
		$f = 100\text{Hz}$	-	2.8	-	nV/ $\sqrt{\text{Hz}}$
		$f = 1\text{kHz}$	-	2.5	-	nV/ $\sqrt{\text{Hz}}$
		$f = 10\text{kHz}$	-	2.5	-	nV/ $\sqrt{\text{Hz}}$
i_n	Current Noise Density	$f = 10\text{kHz}$	-	0.4	-	pA/ $\sqrt{\text{Hz}}$
THD + N	Total Harmonic Distortion + Noise	1kHz, $G = 1$, $V_O = 3.5V_{\text{RMS}}$, $R_L = 2\text{k}\Omega$	-	0.00022	-	%
TRANSIENT RESPONSE						
SR	Slew Rate	$A_V = 10$, $R_L = 2\text{k}\Omega$, $V_O = 4V_{\text{P-P}}$	-	± 3.6	-	V/ μs
t_r , t_f , Small Signal	Rise Time 10% to 90% of V_{OUT}	$A_V = -1$, $V_{\text{OUT}} = 100\text{mV}_{\text{P-P}}$ $R_f = R_g = 2\text{k}\Omega$, $R_L = 2\text{k}\Omega$ to V_{CM}	-	36	-	ns
	Fall Time 90% to 10% of V_{OUT}	$A_V = -1$, $V_{\text{OUT}} = 100\text{mV}_{\text{P-P}}$ $R_f = R_g = 2\text{k}\Omega$, $R_L = 2\text{k}\Omega$ to V_{CM}	-	38	-	ns
t_s	Settling Time to 0.1% 10V Step; 10% to V_{OUT}	$A_V = -1$, $V_{\text{OUT}} = 10V_{\text{P-P}}$ $R_g = R_f = 10\text{k}$, $R_L = 2\text{k}\Omega$ to V_{CM}	-	3.4	-	μs
	Settling Time to 0.01% 10V Step; 10% to V_{OUT}	$A_V = -1$, $V_{\text{OUT}} = 10V_{\text{P-P}}$ $R_L = 2\text{k}\Omega$ to V_{CM}	-	3.8	-	μs
t_{OL}	Output Overload Recovery Time	$A_V = 100$, $V_{\text{IN}} = 0.2V$, $R_L = 2\text{k}\Omega$ to V_{CM}	-	1.7	-	μs

Electrical Specifications ISL28227SEH ($V_S \pm 5V$) $V_{CM} = 0$, $V_O = 0V$, $T_A = +25^\circ\text{C}$, unless otherwise noted. **Boldface limits apply over the -55°C to $+125^\circ\text{C}$ operating temperature range. The limits also define room temperature post-irradiation performance following ^{60}Co irradiation at 0.01rad(Si)/s to a total dose of 50krad(Si) wafer-by-wafer acceptance.**

PARAMETER	DESCRIPTION	TEST CONDITIONS	MIN (Note 13)	TYP	MAX (Note 13)	UNIT
V_{OS}	Offset Voltage		-	-10	-	μV
TCV_{OS}	Offset Voltage Drift		-	.1	-	$\mu\text{V}/^\circ\text{C}$
I_{OS}	Input Offset Current		-	1	-	nA
I_{B}	Input Bias Current		-	1	-	nA
CMRR	Common-Mode Rejection Ratio	$V_{\text{CM}} = -3V$ to $+3V$	-	120	-	dB
PSRR	Power Supply Rejection Ratio	$V_S = \pm 2.25V$ to $\pm 5V$	-	125	-	dB
A_{VOL}	Open-Loop Gain	$V_O = -3V$ to $+3V$ $R_L = 10\text{k}\Omega$ to ground	-	1500	-	V/mV
V_{OH}	Output Voltage High	$R_L = 10\text{k}\Omega$ to ground	-	3.65	-	V
		$R_L = 2\text{k}\Omega$ to ground	-	3.5	-	V
V_{OL}	Output Voltage Low	$R_L = 10\text{k}\Omega$ to ground	-	-3.65	-	V
		$R_L = 2\text{k}\Omega$ to ground	-	-3.5	-	V
I_S	Supply Current/Amplifier		-	2.2	-	mA

Electrical Specifications ISL28227SEH ($V_S \pm 5V$) $V_{CM} = 0$, $V_O = 0V$, $T_A = +25^\circ C$, unless otherwise noted. **Boldface limits apply over the $-55^\circ C$ to $+125^\circ C$ operating temperature range. The limits also define room temperature post-irradiation performance following ^{60}Co irradiation at $0.01rad(Si)/s$ to a total dose of $50krad(Si)$ wafer-by-wafer acceptance. (Continued)**

PARAMETER	DESCRIPTION	TEST CONDITIONS	MIN (Note 13)	TYP	MAX (Note 13)	UNIT
I_{SC}	Short-Circuit		-	± 45	-	mA
AC SPECIFICATIONS						
GBW	Gain Bandwidth Product		-	10	-	MHz
THD + N	Total Harmonic Distortion + Noise	1kHz, G = 1, $V_o = 2.5V_{RMS}$, $R_L = 2k\Omega$	-	0.0034	-	%
TRANSIENT RESPONSE						
SR	Slew Rate	$A_V = 10$, $R_L = 2k\Omega$	-	± 3.6	-	V/ μs
t_r , t_f , Small Signal	Rise Time 10% to 90% of V_{OUT}	$A_V = -1$, $V_{OUT} = 100mV_{P-P}$, $R_f = R_g = 2k\Omega$, $R_L = 2k\Omega$ to V_{CM}	-	36	-	ns
	Fall Time 90% to 10% of V_{OUT}	$A_V = -1$, $V_{OUT} = 100mV_{P-P}$, $R_f = R_g = 2k\Omega$, $R_L = 2k\Omega$ to V_{CM}	-	38	-	ns
t_s	Settling Time to 0.1%	$A_V = -1$, $V_{OUT} = 4V_{P-P}$, $R_f = R_g = 2k\Omega$, $R_L = 2k\Omega$ to V_{CM}	-	1.6	-	μs
	Settling Time to 0.01%	$A_V = -1$, $V_{OUT} = 4V_{P-P}$, $R_f = R_g = 2k\Omega$, $R_L = 2k\Omega$ to V_{CM}	-	4.2	-	μs

NOTE:

13. Compliance to datasheet limits is assured by one or more methods: production test, characterization and/or design.

Typical Performance Curves

$V_S = \pm 15V$, $V_{CM} = 0V$, $R_L = \text{Open}$, unless otherwise specified.

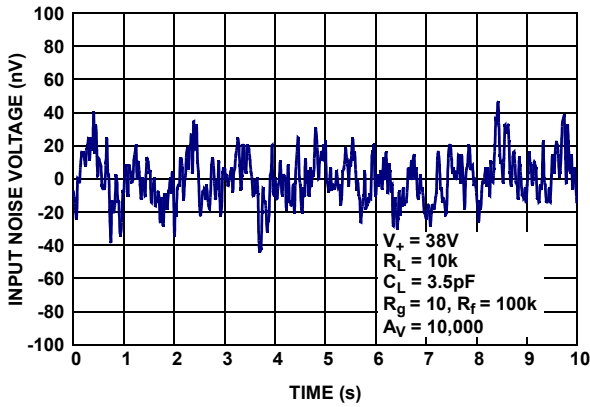

FIGURE 3. INPUT NOISE VOLTAGE 0.1Hz to 10Hz

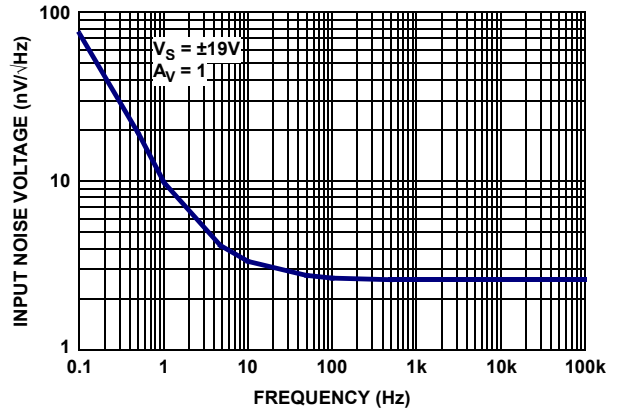

FIGURE 4. INPUT NOISE VOLTAGE SPECTRAL DENSITY

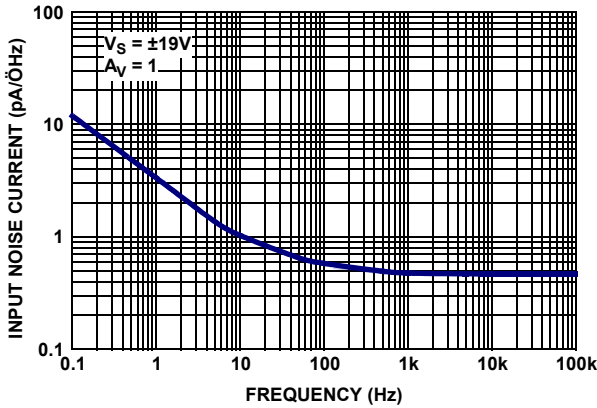

FIGURE 5. INPUT NOISE CURRENT SPECTRAL DENSITY

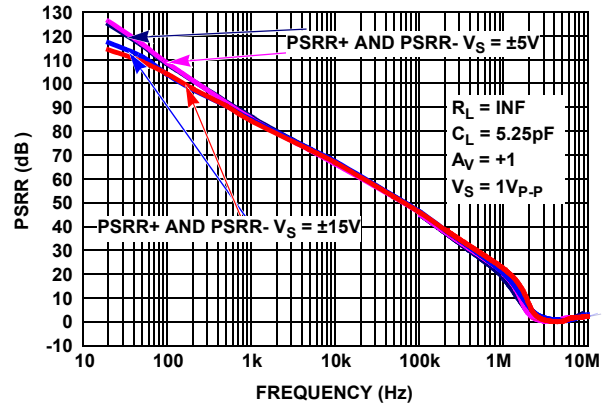

FIGURE 6. PSRR vs FREQUENCY, $V_S = \pm 5V, \pm 15V$

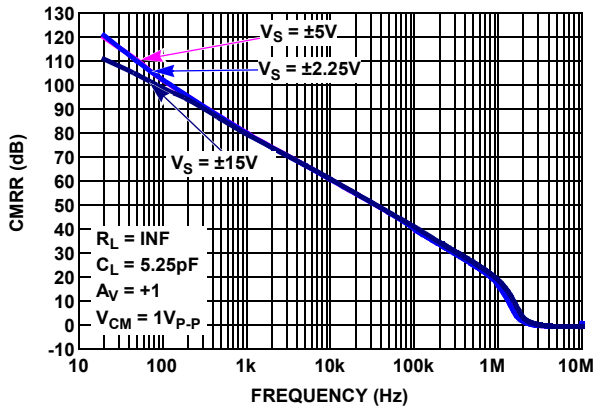

FIGURE 7. CMRR vs FREQUENCY, $V_S = \pm 2.25, \pm 5V, \pm 15V$

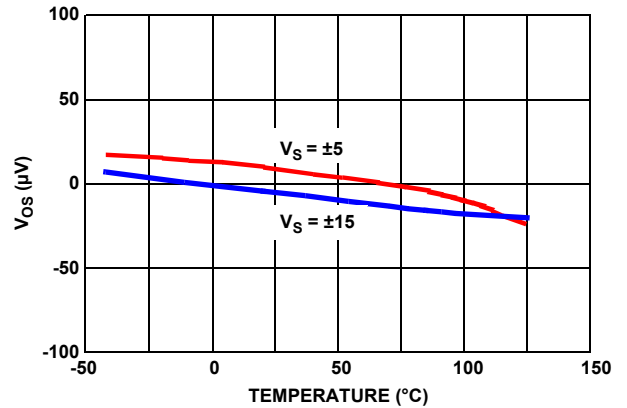

FIGURE 8. V_{OS} vs TEMPERATURE vs V_{SUPPLY}

Typical Performance Curves

$V_S = \pm 15V, V_{CM} = 0V, R_L = \text{Open}$, unless otherwise specified. (Continued)

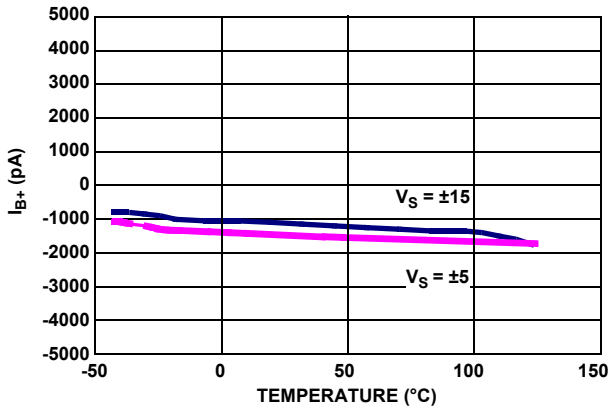

FIGURE 9. I_{B+} vs TEMPERATURE vs SUPPLY VOLTAGE

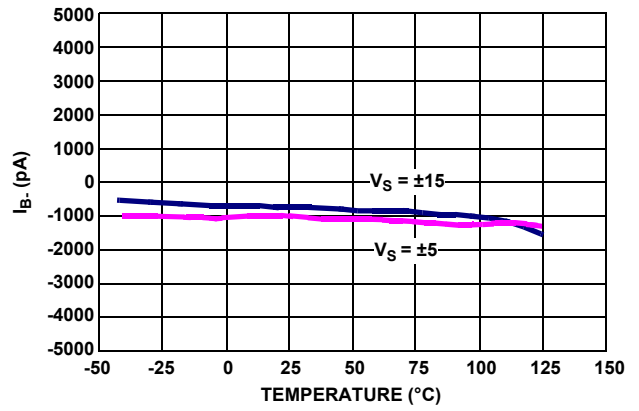

FIGURE 10. I_{B-} vs TEMPERATURE vs SUPPLY VOLTAGE

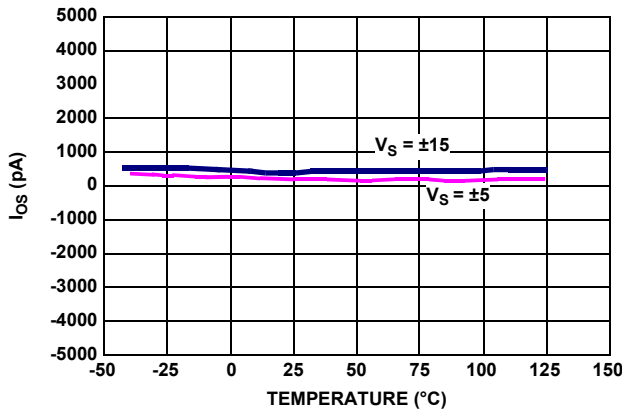

FIGURE 11. I_{OS} vs TEMPERATURE vs SUPPLY VOLTAGE

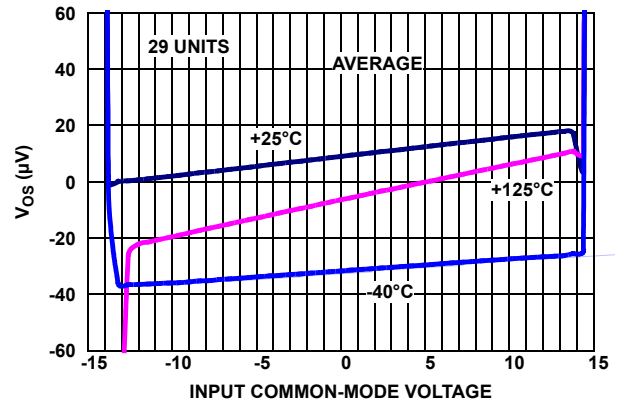

FIGURE 12. INPUT OFFSET VOLTAGE vs INPUT COMMON-MODE VOLTAGE, $V_S = \pm 15V$

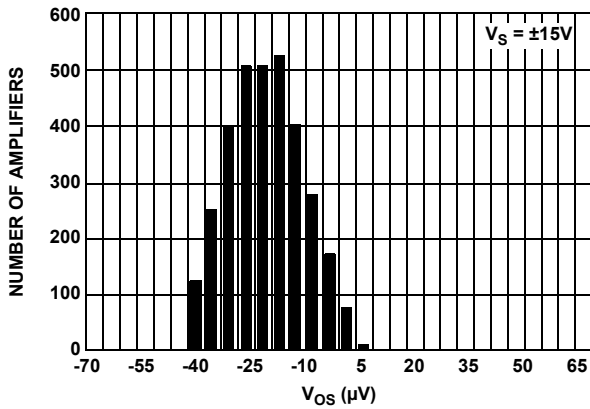

FIGURE 13. INPUT OFFSET VOLTAGE DISTRIBUTION, $V_S = \pm 15V$

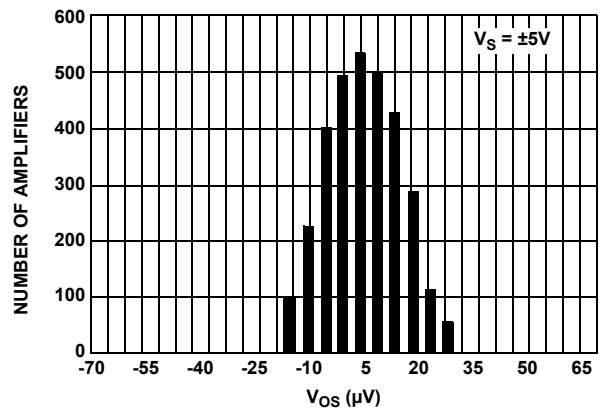

FIGURE 14. INPUT OFFSET VOLTAGE DISTRIBUTION, $V_S = \pm 5V$

Typical Performance Curves

$V_S = \pm 15V, V_{CM} = 0V, R_L = \text{Open}$, unless otherwise specified. (Continued)

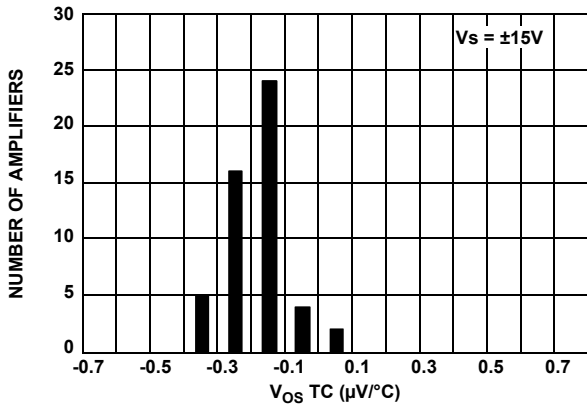

FIGURE 15. OFFSET VOLTAGE DRIFT DISTRIBUTION, $V_S = \pm 15V$

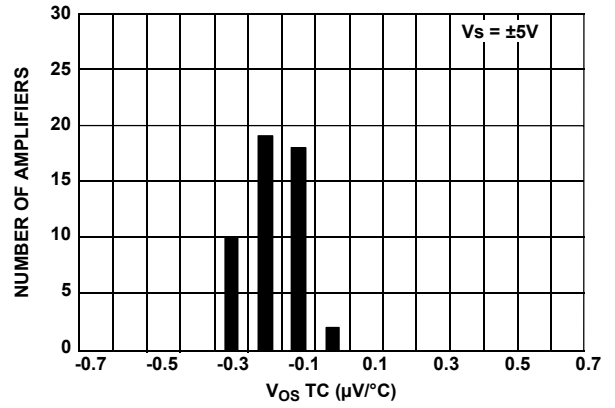

FIGURE 16. OFFSET VOLTAGE DRIFT DISTRIBUTION, $V_S = \pm 5V$

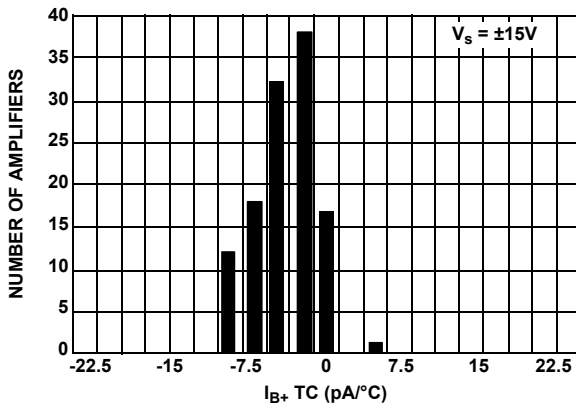

FIGURE 17. I_{B+} INPUT BIAS CURRENT DRIFT DISTRIBUTION, $V_S = \pm 15V$

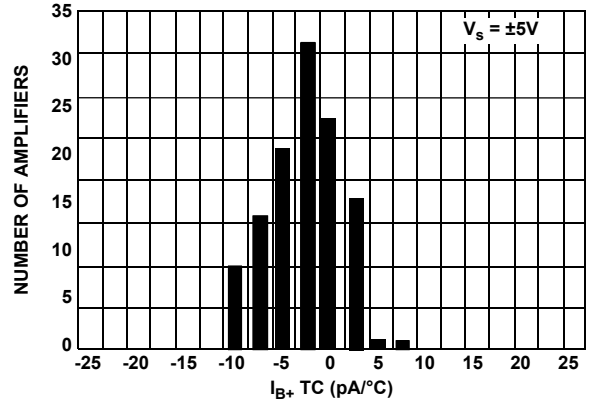

FIGURE 18. I_{B+} INPUT BIAS CURRENT DRIFT DISTRIBUTION, $V_S = \pm 5V$

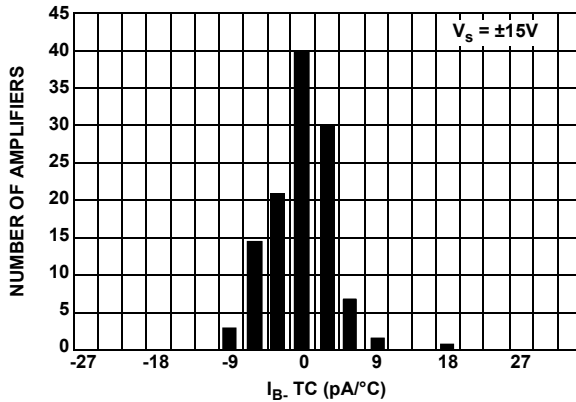

FIGURE 19. I_{B-} INPUT BIAS CURRENT DRIFT DISTRIBUTION, $V_S = \pm 15V$

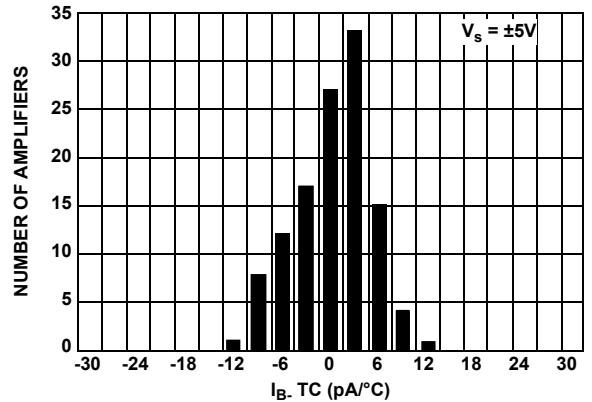

FIGURE 20. I_{B-} INPUT BIAS CURRENT DRIFT DISTRIBUTION, $V_S = \pm 5V$

Typical Performance Curves

$V_S = \pm 15V, V_{CM} = 0V, R_L = \text{Open}$, unless otherwise specified. (Continued)

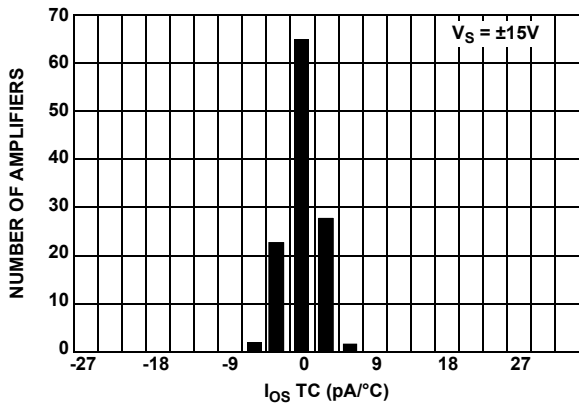

FIGURE 21. INPUT OFFSET CURRENT DISTRIBUTION, $V_S = \pm 15V$

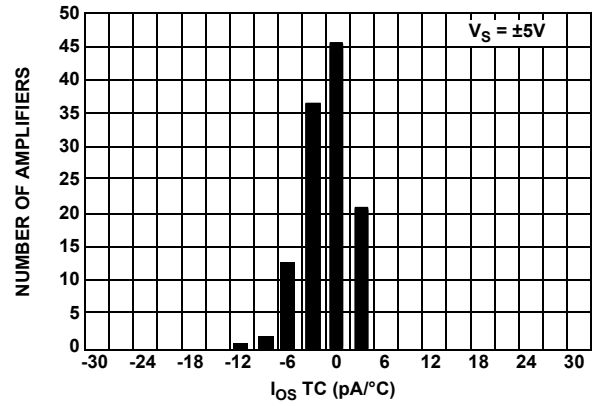

FIGURE 22. INPUT OFFSET CURRENT DISTRIBUTION, $V_S = \pm 5V$

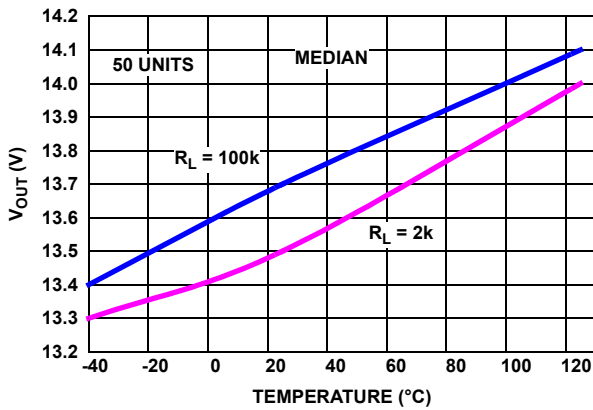

FIGURE 23. V_{OH} vs TEMPERATURE, $V_S = \pm 15V$

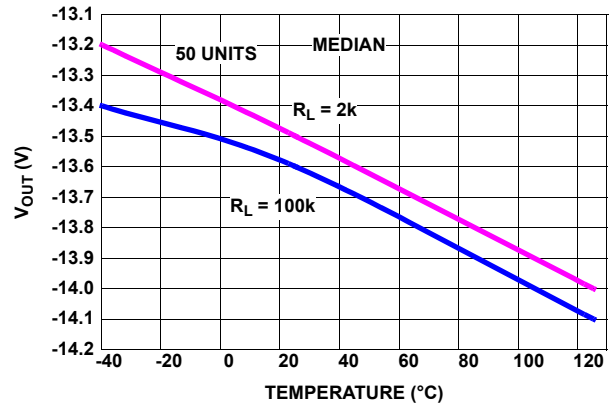

FIGURE 24. V_{OL} vs TEMPERATURE, $V_S = \pm 15V$

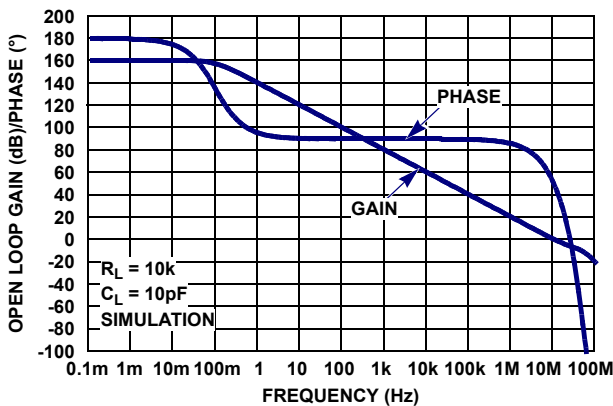

FIGURE 25. OPEN-LOOP GAIN, PHASE vs FREQUENCY, $R_L = 10k\Omega, C_L = 10pF$

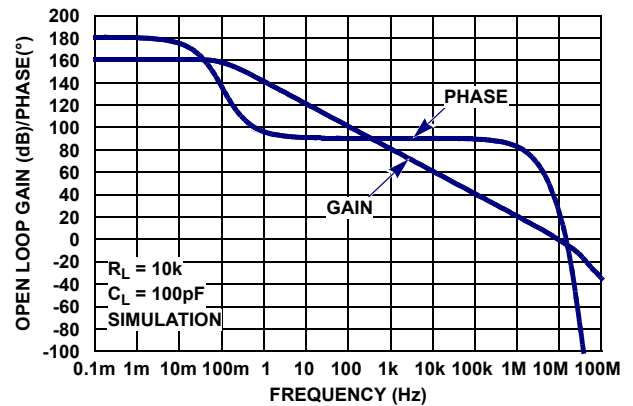

FIGURE 26. OPEN-LOOP GAIN, PHASE vs FREQUENCY, $R_L = 10k\Omega, C_L = 100pF$

Typical Performance Curves

$V_S = \pm 15V, V_{CM} = 0V, R_L = \text{Open}$, unless otherwise specified. (Continued)

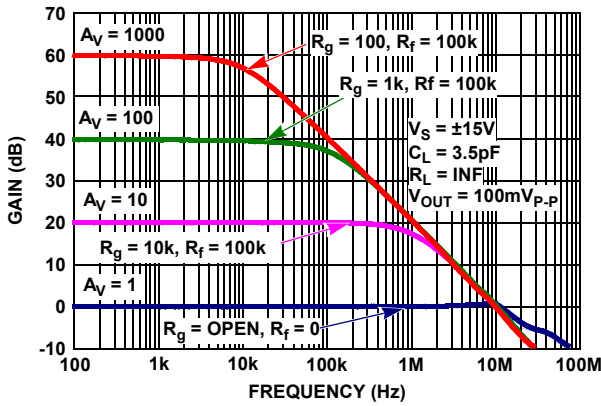

FIGURE 27. FREQUENCY RESPONSE vs CLOSED LOOP GAIN

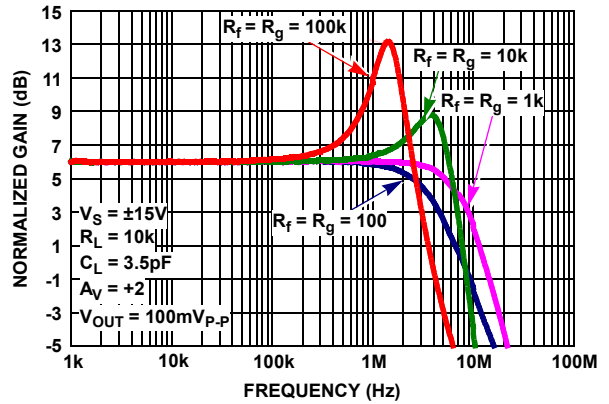

FIGURE 28. FREQUENCY RESPONSE vs FEEDBACK RESISTANCE R_f/R_g

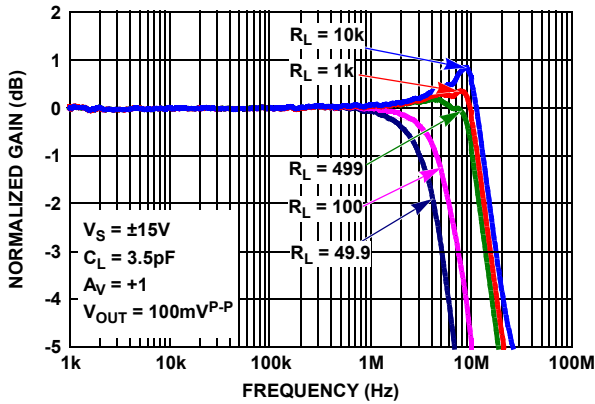

FIGURE 29. GAIN vs FREQUENCY vs R_L

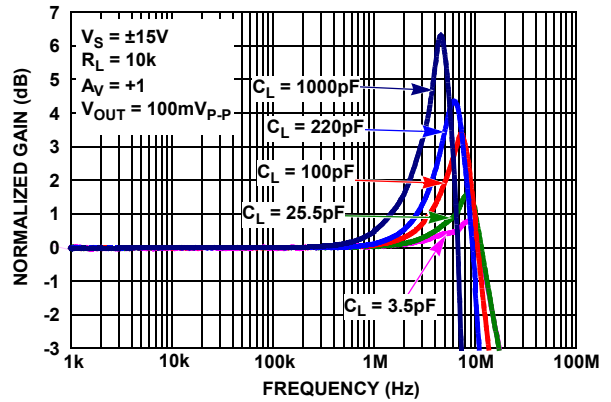

FIGURE 30. GAIN vs FREQUENCY vs C_L

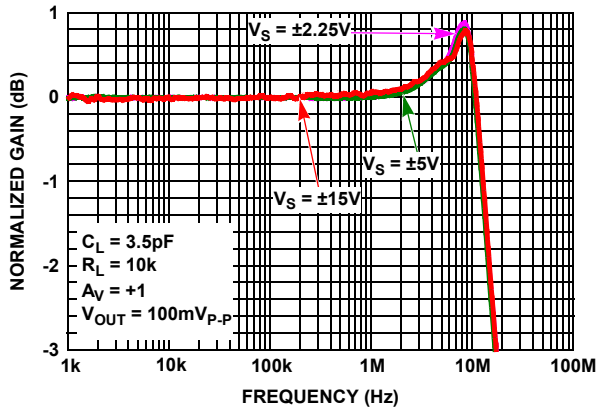

FIGURE 31. GAIN vs FREQUENCY vs SUPPLY VOLTAGE

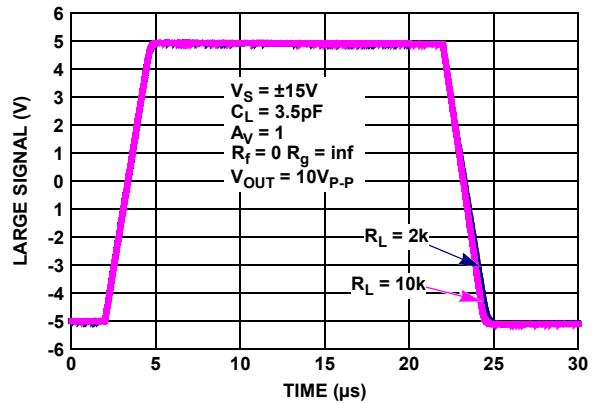

FIGURE 32. LARGE SIGNAL 10V STEP RESPONSE, $V_S = \pm 15V$

Typical Performance Curves

$V_S = \pm 15V, V_{CM} = 0V, R_L = \text{Open}$, unless otherwise specified. (Continued)

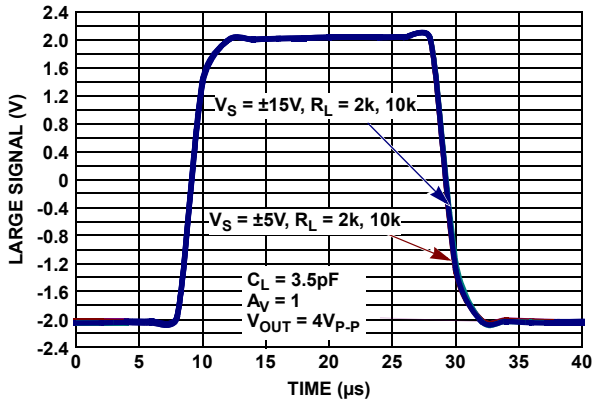

FIGURE 33. LARGE SIGNAL TRANSIENT RESPONSE vs R_L $V_S = \pm 5V, \pm 15V$

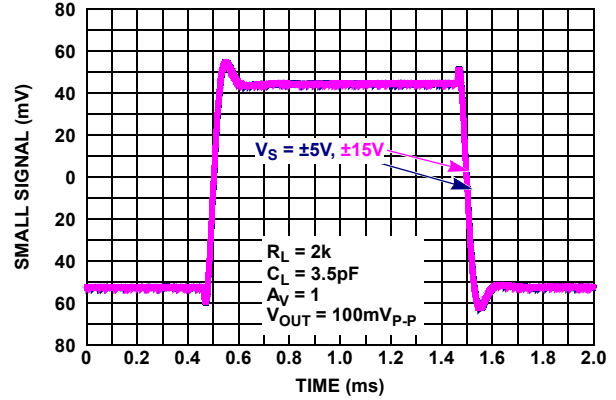

FIGURE 34. SMALL SIGNAL TRANSIENT RESPONSE, $V_S = \pm 5V, \pm 15V$

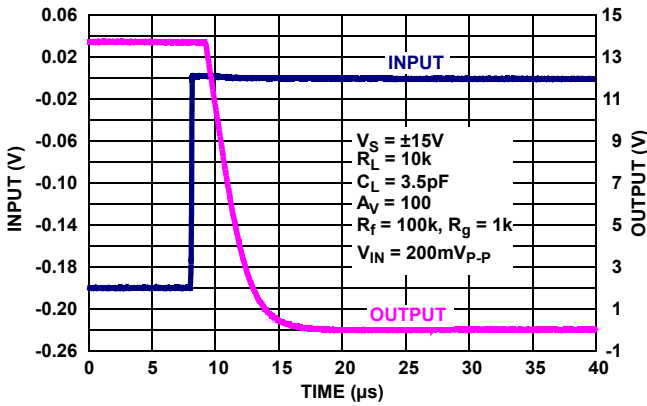

FIGURE 35. POSITIVE OUTPUT OVERLOAD RESPONSE TIME, $V_S = \pm 15V$

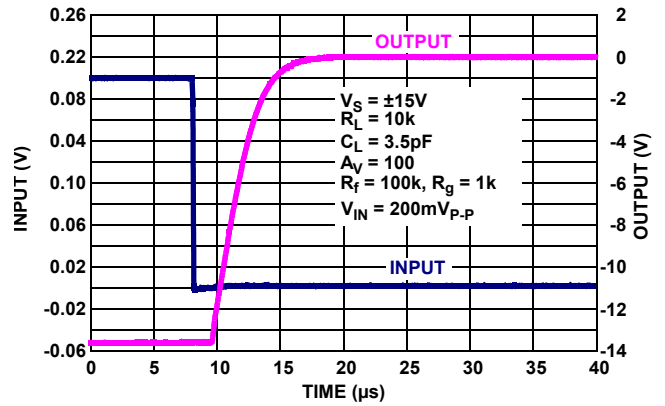

FIGURE 36. NEGATIVE OUTPUT OVERLOAD RESPONSE TIME, $V_S = \pm 15V$

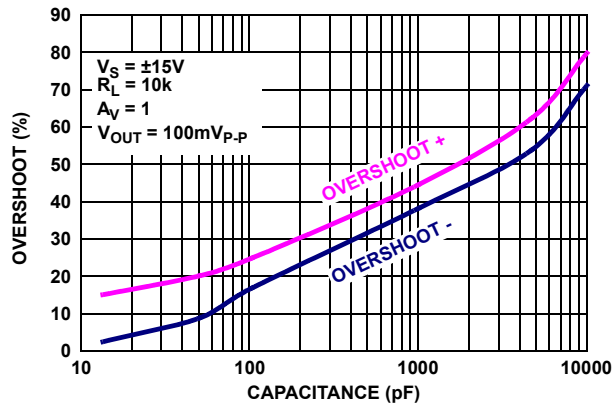

FIGURE 37. % OVERSHOOT vs LOAD CAPACITANCE, $V_S = \pm 15V$

Applications Information

Functional Description

The ISL28127, ISL28227 and ISL28227SEH are single and dual, low noise 10MHz BW precision op amps. All devices are fabricated in a new precision 40V complementary bipolar DI process. A super-beta NPN input stage with input bias current cancellation provides low input bias current (1nA typical), low input offset voltage (10µV typical), low input noise voltage (3nV/√Hz) and low 1/f noise corner frequency (5Hz). These amplifiers also feature high open loop gain (1500V/mV) for excellent CMRR (120dB) and THD+N performance (0.0002% at 3.5V_{RMS}, 1kHz into 2kΩ). A complimentary bipolar output stage enables high capacitive load drive without external compensation.

Operating Voltage Range

The devices are designed to operate over the 4.5V (±2.25V) to 40V (±20V) range and are fully characterized at 10V (±5V) and 30V (±15V). Parameter variation with operating voltage is shown in the “Typical Performance Curves” beginning on [page 13](#).

Input ESD Diode Protection

The input terminals (IN+ and IN-) have internal ESD protection diodes to the positive and negative supply rails and an additional anti-parallel diode pair across the inputs (see [Figures 38 and 39](#)).

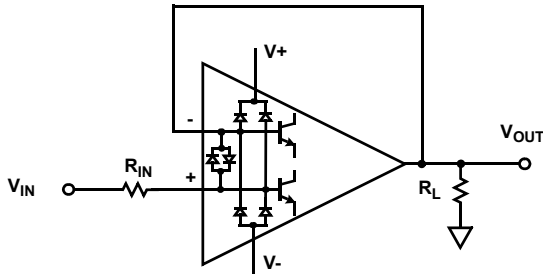

FIGURE 38. INPUT ESD DIODE CURRENT LIMITING - UNITY GAIN

For unity gain applications (see [Figure 38](#)) where the output is connected directly to the non-inverting input a current limiting resistor (R_{IN}) will be needed under the following conditions to protect the anti-parallel differential input protection diodes.

- The amplifier input is supplied from a low impedance source.
- The input voltage rate-of-rise (dV/dt) exceeds the maximum slew rate of the amplifier (±3.6V/µs).

If the output lags far enough behind the input, the anti-parallel input diodes can conduct. For example, if an input pulse ramps from 0V to +10V in 1µs, then the output of the amplifier will reach only +3.6V (slew rate = 3.6V/µs) while the input is at 10V. The input differential voltage of 6.4V will force input ESD diodes to conduct, dumping the input current directly into the output stage and the load. The resulting current flow can cause permanent damage to the ESD diodes. The ESD diodes are rated to 20mA and in the previous example, setting R_{IN} to 1k resistor (see [Figure 38](#)) would limit the current to < 6.4mA and provide additional protection up to ±20V at the input.

In applications where one or both amplifier input terminals are at risk of exposure to high voltage, current limiting resistors may be

needed at each input terminal (see [Figure 39](#) R_{IN+} , R_{IN-}) to limit current through the power supply ESD diodes to 20mA.

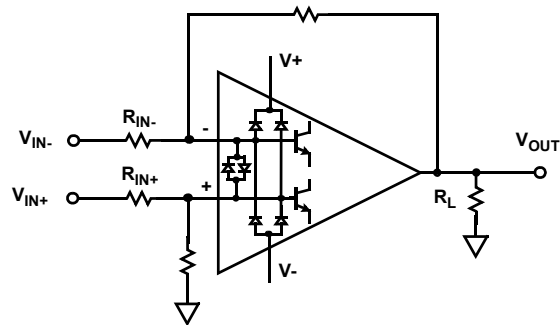

FIGURE 39. INPUT ESD DIODE CURRENT LIMITING DIFFERENTIAL INPUT

Output Current Limiting

The output current is internally limited to approximately ±45mA at +25°C and can withstand short-circuit to either rail as long as the power dissipation limits are not exceeded. This applies to only 1 amplifier at a time for the dual op amp. Continuous operation under these conditions may degrade long term reliability.

Output Phase Reversal

Output phase reversal is a change of polarity in the amplifier transfer function when the input voltage exceeds the supply voltage. The ISL28127, ISL28227 and ISL28227SEH are immune to output phase reversal, even when the input voltage is 1V beyond the supplies.

Unused Channels

The user must configure unused channels to prevent them from oscillating. The unused channel(s) oscillates if the input and output pins are floating. This results in higher than expected supply currents and possible noise injection into the other channel(s) being used. The proper way to prevent this oscillation is to short the output to the inverting input and ground the positive input, as shown in [Figure 40](#).

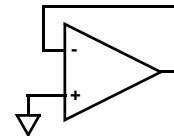

FIGURE 40. PREVENTING OSCILLATIONS IN UNUSED CHANNELS

Power Dissipation

It is possible to exceed the +150°C maximum junction temperatures under certain load and power supply conditions. It is therefore important to calculate the maximum junction temperature (T_{JMAX}) for all applications to determine if power supply voltages, load conditions, or package type need to be modified to remain in the safe operating area. These parameters are related using [Equation 1](#):

$$T_{JMAX} = T_{MAX} + \theta_{JA} \times P_{D_{MAXTOTAL}} \quad (EQ. 1)$$

Where:

- $P_{\text{DMAXTOTAL}}$ is the sum of the maximum power dissipation of each amplifier in the package (P_{DMAX})
- P_{DMAX} for each amplifier can be calculated using [Equation 2](#):

$$P_{\text{DMAX}} = V_S \times I_{\text{qMAX}} + (V_S - V_{\text{OUTMAX}}) \times \frac{V_{\text{OUTMAX}}}{R_L} \quad (\text{EQ. 2})$$

Where:

- T_{MAX} = Maximum ambient temperature
- θ_{JA} = Thermal resistance of the package
- P_{DMAX} = Maximum power dissipation of 1 amplifier
- V_S = Total supply voltage
- I_{qMAX} = Maximum quiescent supply current of 1 amplifier
- V_{OUTMAX} = Maximum output voltage swing of the application
- R_L = Load resistance

ISL28127, ISL28227 SPICE Model

[Figure 41](#) shows the SPICE model schematic and [Figure 42](#) shows the net list for the ISL28127, ISL28227 SPICE model. The model is a simplified version of the actual device and simulates important AC and DC parameters. AC parameters incorporated into the model are: 1/f and flatband noise, slew rate, CMRR, gain and phase. The DC parameters are V_{OS} , I_{OS} , total supply current and output voltage swing. The model does not model input bias current. The model uses typical parameters given in the “Electrical Specifications” Table beginning on [page 6](#). The A_{VOL} is adjusted for 128dB with the dominant pole at 5Hz. The CMRR is set higher than the “Electrical Specifications” table beginning on [page 6](#) to better match design simulations (150dB, $f = 50\text{Hz}$). The input stage models the actual device to present an accurate AC representation. The model is configured for +25 °C ambient temperature. The Spice model for the ISL28227SEH can be found here [“ISL70227SEH SPICE MODEL”](#).

[Figures 43](#) through [58](#) show the characterization vs simulation results for the noise voltage, closed loop gain vs frequency, closed loop gain vs R_f/R_g , closed loop gain vs R_L , closed loop gain vs C_L , large signal 10V step response, open loop gain phase and simulated CMRR vs frequency.

LICENSE STATEMENT

The information in this SPICE model is protected under the United States copyright laws. Intersil Corporation hereby grants users of this macro-model hereto referred to as “Licensee”, a nonexclusive, nontransferable license to use this model as long as the Licensee abides by the terms of this agreement. Before using this macro-model, the Licensee should read this license. If the Licensee does not accept these terms, permission to use the model is not granted.

The Licensee may not sell, loan, rent, or license the macro-model, in whole, in part, or in modified form, to anyone outside the Licensee’s company. The Licensee may modify the macro-model to suit his/her specific applications and the Licensee may make copies of this macro-model for use within their company only.

This macro-model is provided “AS IS, WHERE IS AND WITH NO WARRANTY OF ANY KIND EITHER EXPRESSED OR IMPLIED, INCLUDING, BUT NOT LIMITED TO, ANY IMPLIED WARRANTIES OF MERCHANTABILITY AND FITNESS FOR A PARTICULAR PURPOSE.”

In no event will Intersil be liable for special, collateral, incidental, or consequential damages in connection with or arising out of the use of this macro-model. Intersil reserves the right to make changes to the product and the macro-model without prior notice.

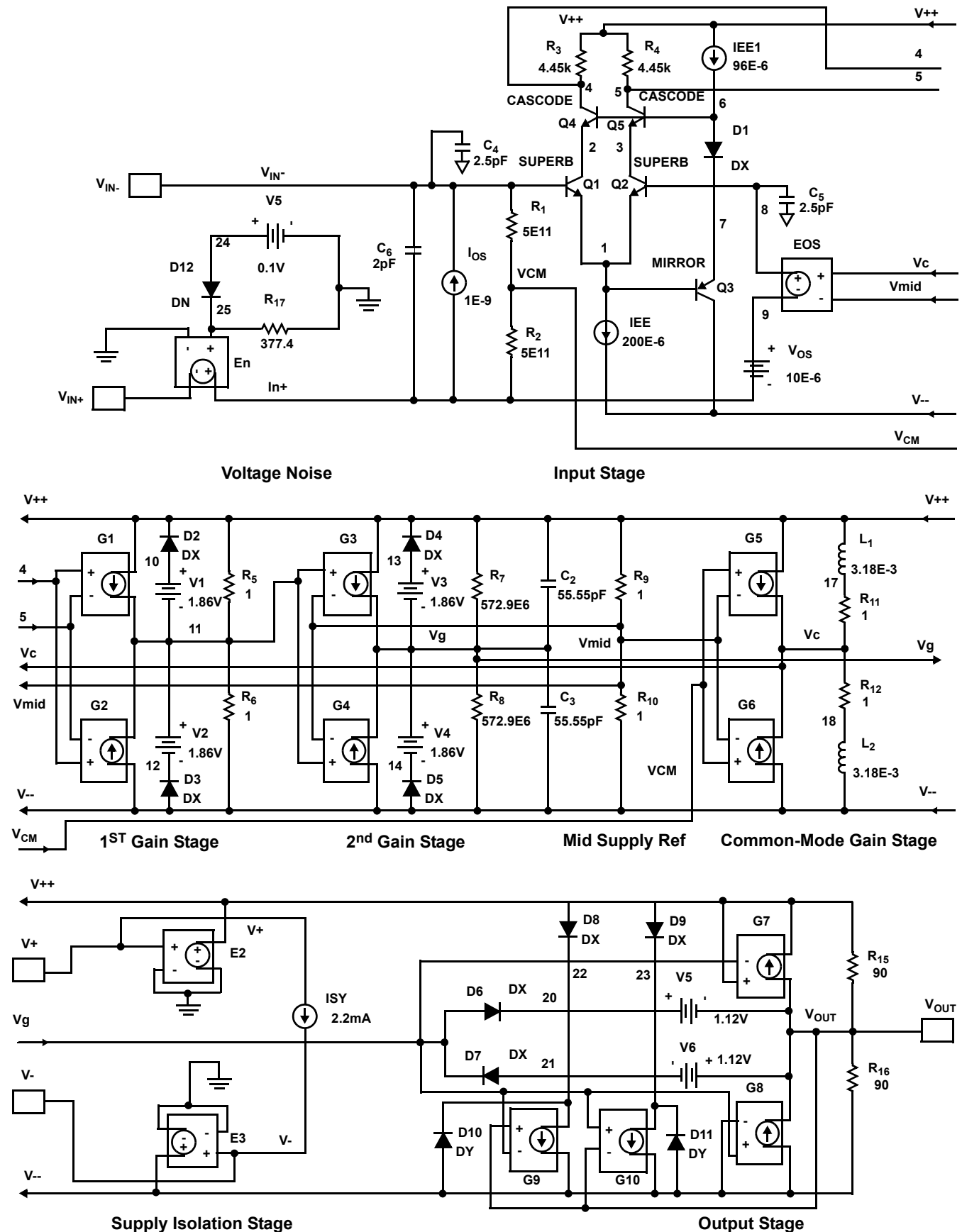

FIGURE 41. SPICE SCHEMATIC

```

* source ISL28127_SPICEmodel
* Revision C, August 8th 2009 LaFontaine
* Model for Noise, supply currents, 150dB f=50Hz
CMRR, *128dB f=5Hz AOL
*Copyright 2009 by Intersil Corporation
*Refer to data sheet "LICENSE STATEMENT" Use of
*this model indicates your acceptance with the
*terms and provisions in the License Statement.
* Connections: +input
*               |         -input
*               |         |         +Vsupply
*               |         |         |         -Vsupply
*               |         |         |         |         output
*               |         |         |         |         |
.subckt ISL28127subckt Vin+ Vin-V+ V- VOUT
* source ISL28127_SPICEMODEL_0_0
*
*Voltage Noise
E_En      IN+ VIN+ 25 0 1
R_R17     25 0 377.4 TC=0,0
D_D12     24 25 DN
V_V7      24 0 0.1
*
*Input Stage
I_IOS     IN+ VIN- DC 1e-9
C_C6      IN+ VIN- 2E-12
R_R1      VCM VIN- 5e11 TC=0,0
R_R2      IN+ VCM 5e11 TC=0,0
Q_Q1      2 VIN- 1 SuperB
Q_Q2      3 8 1 SuperB
Q_Q3      V-- 1 7 Mirror
Q_Q4      4 6 2 Cascode
Q_Q5      5 6 3 Cascode
R_R3      4 V++ 4.45e3 TC=0,0
R_R4      5 V++ 4.45e3 TC=0,0
C_C4 VIN- 0 2.5e-12
C_C5 8 0 2.5e-12
D_D1      6 7 DX
I_IEE     1 V-- DC 200e-6
I_IEE1    V++ 6 DC 96e-6
V_VOS     9 IN+ 10e-6
E_EOS     8 9 VC VMID 1
*
*1st Gain Stage
G_G1      V++ 11 4 5 0.0487707
G_G2      V-- 11 4 5 0.0487707
R_R5      11 V++ 1 TC=0,0
R_R6      V-- 11 1 TC=0,0
D_D2      10 V++ DX
D_D3      V-- 12 DX
V_V1      10 11 1.86
V_V2      11 12 1.86
*
*2nd Gain Stage
G_G3      V++ VG 11 VMID 4.60767E-3
G_G4      V-- VG 11 VMID 4.60767E-3
R_R7      VG V++ 572.958E6 TC=0,0
R_R8      V-- VG 572.958E6 TC=0,0
C_C2      VG V++ 55.55e-12 TC=0,0
C_C3      V-- VG 55.55e-12 TC=0,0
D_D4      13 V++ DX
D_D5      V-- 14 DX
V_V3      13 VG 1.86
V_V4      VG 14 1.86
*
*Mid supply Ref
R_R9      VMID V++ 1 TC=0,0
R_R10     V-- VMID 1 TC=0,0
I_ISY     V+ V- DC 2.2E-3
E_E2      V++ 0 V+ 0 1
E_E3      V-- 0 V- 0 1
*
*Common Mode Gain Stage with Zero
G_G5      V++ VC VCM VMID 31.6228e-9
G_G6      V-- VC VCM VMID 31.6228e-9
R_R11     VC 17 1 TC=0,0
R_R12     18 VC 1 TC=0,0
L_L1      17 V++ 3.183e-3
L_L2      18 V-- 3.183e-3
*
*Output Stage with Correction Current Sources
G_G7      VOUT V++ V++ VG 1.11e-2
G_G8      V-- VOUT VG V-- 1.11e-2
G_G9      22 V-- VOUT VG 1.11e-2
G_G10     23 V-- VG VOUT 1.11e-2
D_D6      VG 20 DX
D_D7      21 VG DX
D_D8      V++ 22 DX
D_D9      V++ 23 DX
D_D10     V-- 22 DY
D_D11     V-- 23 DY
V_V5      20 VOUT 1.12
V_V6      VOUT 21 1.12
R_R15     VOUT V++ 9E1 TC=0,0
R_R16     V-- VOUT 9E1 TC=0,0
*
.model SuperB npn
+ is=184E-15 bf=30e3 va=15 ik=70E-3 rb=50
+ re=0.065 rc=35 cje=1.5E-12 cjc=2E-12
+ kf=0 af=0
.model Cascode npn
+ is=502E-18 bf=150 va=300 ik=17E-3 rb=140
+ re=0.011 rc=900 cje=0.2E-12 cjc=0.16E-12f
+ kf=0 af=0
.model Mirror pnp
+ is=4E-15 bf=150 va=50 ik=138E-3 rb=185
+ re=0.101 rc=180 cje=1.34E-12 cjc=0.44E-12
+ kf=0 af=0
.model DN D(KF=6.69e-9 AF=1)
.MODEL DX D(IS=1E-12 Rs=0.1)
.MODEL DY D(IS=1E-15 BV=50 Rs=1)
.ends ISL28127subckt

```

FIGURE 42. SPICE NET LIST

Characterization vs Simulation Results

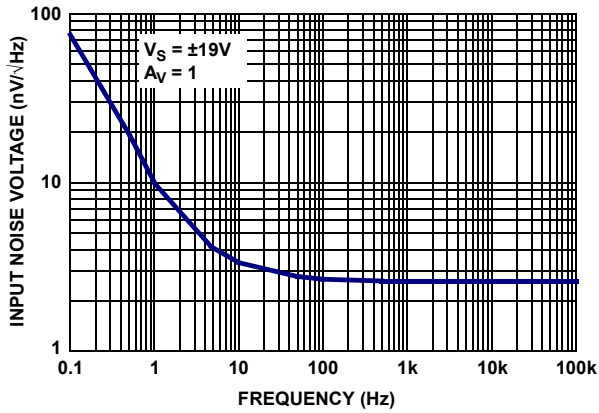

FIGURE 43. CHARACTERIZED INPUT NOISE VOLTAGE

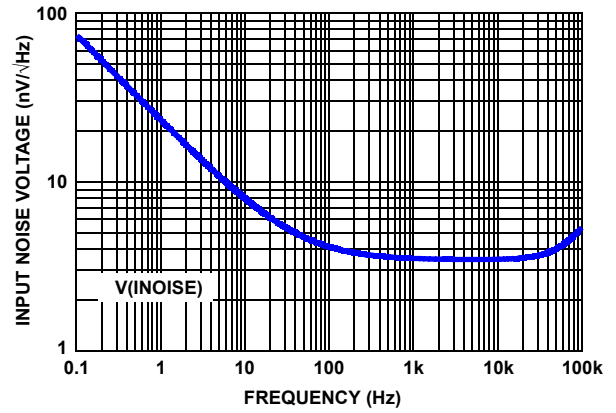

FIGURE 44. SIMULATED INPUT NOISE VOLTAGE

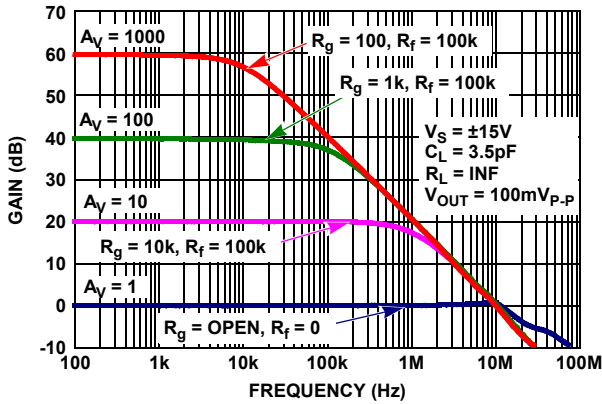

FIGURE 45. CHARACTERIZED CLOSED LOOP GAIN vs FREQUENCY

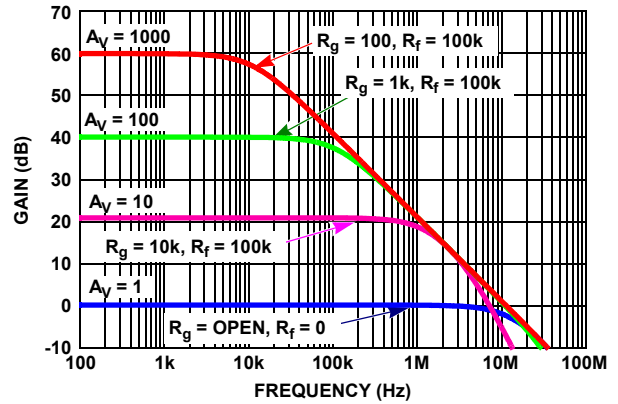

FIGURE 46. SIMULATED CLOSED LOOP GAIN vs FREQUENCY

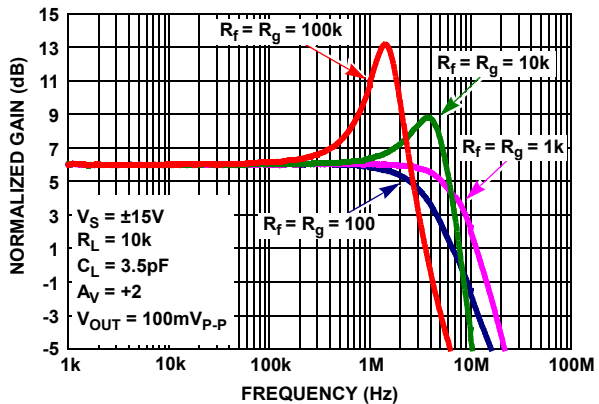

FIGURE 47. CHARACTERIZED CLOSED LOOP GAIN vs R_f/R_g

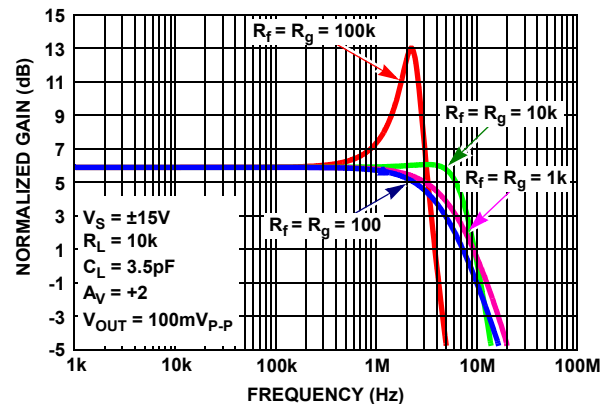

FIGURE 48. SIMULATED CLOSED LOOP GAIN vs R_f/R_g

Characterization vs Simulation Results (Continued)

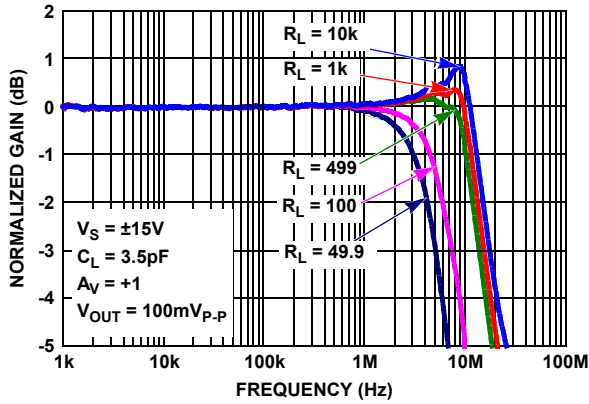

FIGURE 49. CHARACTERIZED CLOSED LOOP GAIN vs R_L

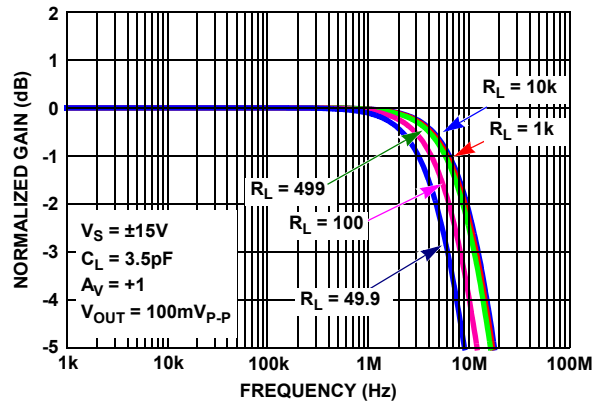

FIGURE 50. SIMULATED CLOSED LOOP GAIN vs R_L

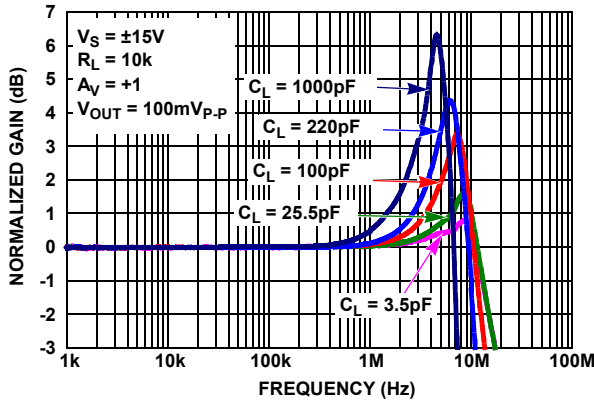

FIGURE 51. CHARACTERIZED CLOSED LOOP GAIN vs C_L

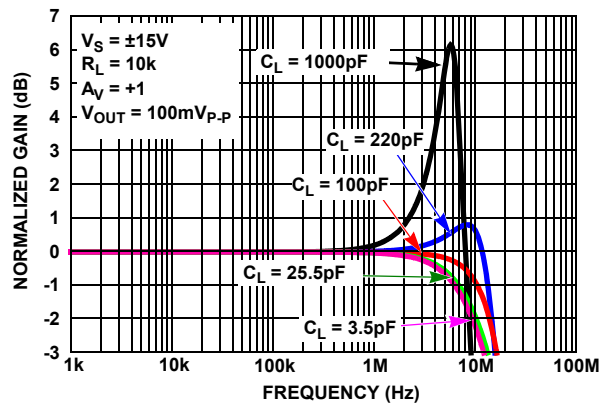

FIGURE 52. SIMULATED CLOSED LOOP GAIN vs C_L

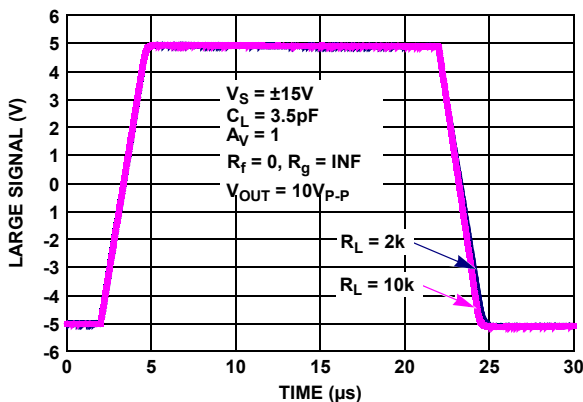

FIGURE 53. CHARACTERIZED LARGE SIGNAL 10V STEP RESPONSE

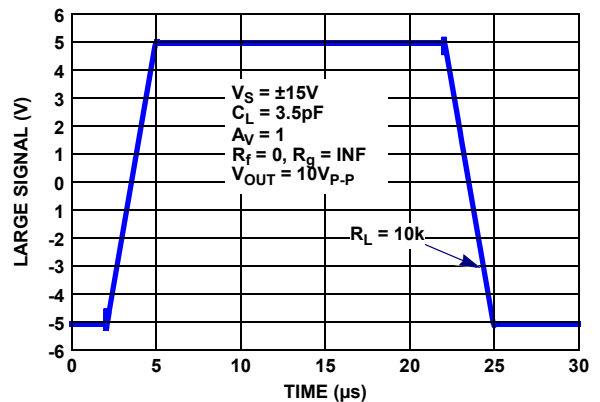

FIGURE 54. SIMULATED LARGE SIGNAL 10V STEP RESPONSE

Characterization vs Simulation Results (Continued)

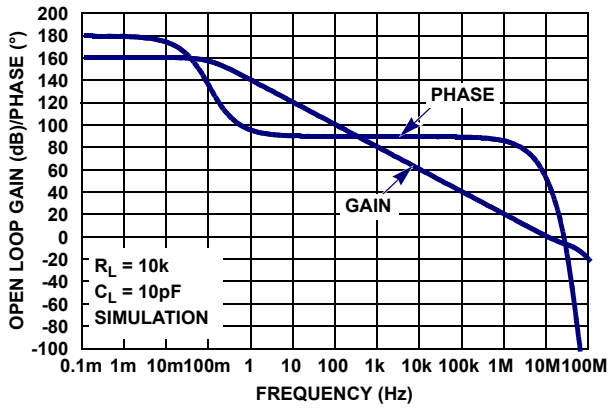

FIGURE 55. SIMULATED OPEN-LOOP GAIN, PHASE vs FREQUENCY

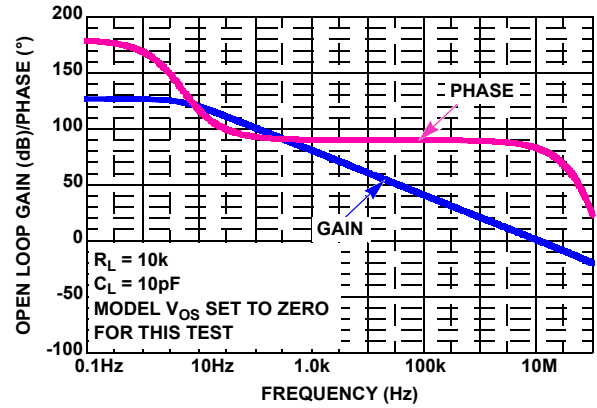

FIGURE 56. SIMULATED OPEN-LOOP GAIN, PHASE vs FREQUENCY

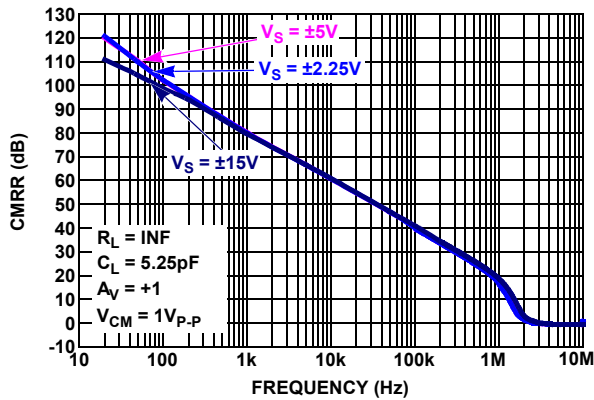

FIGURE 57. CHARACTERIZED CMRR vs FREQUENCY

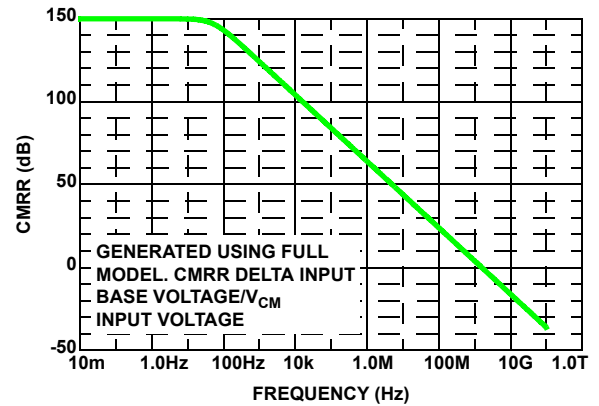

FIGURE 58. SIMULATED CMRR vs FREQUENCY

Revision History

The revision history provided is for informational purposes only and is believed to be accurate, but not warranted. Please go to web to make sure you have the latest Rev.

REVISION	DATE	CHANGE
April 1, 2016	FN6633.8	<ul style="list-style-type: none"> -Added the ISL28227SEH throughout the datasheet. -Updated ordering information on page 3 by changing in Pkg Dwg. # column L8.3x3A to L8.3x3K and M8.118 to M8.118B. -Updated Tjc Note 10 by removing words "the exposed metal pad on" from the sentence to cover both TDFN and Flatpack packages. -Added ISL70227HMEVAL1Z to ordering information table on page 3 and added hermetic package note. - Absolute Maximum Ratings table on page 6 as follow: <ul style="list-style-type: none"> Updated HBM for ISL28127 from 4.0kV to 4.5kV. Added ESD Tolerance for ISL28227SEH. -Updated Electrical Spec Table page 10: ISL28227SEH ($\pm 15V$) for I_{OS} and I_B as follows: <ul style="list-style-type: none"> Added ± 25 Post Rad Added ± 25 Post Rad Added $T_A = -55^\circ C, +125^\circ C$ Added the rad level is implied by the tighter BOLD Temp Spec. -Added ISL28227SEH values. -Updated POD from: L8.3x3A to: L8.3x3k. -Updated POD from: M8.118 to: M8.118B.
September 10, 2015	FN6633.7	<ul style="list-style-type: none"> -Updated About Intersil Verbiage. -Updated POD L8.3X3A to most current version change is as follows: <ul style="list-style-type: none"> From: Tiebar shown (if present) is a non-functional feature. To: Tiebar shown (if present) is a non-functional feature and may be located on any of the 4 sides (or ends). -Updated POD M8.118 to most current version change is as follows: <ul style="list-style-type: none"> Corrected lead width dimension in side view 1 from "0.25 - 0.036" to "0.25 - 0.36"
December 13, 2010	FN6633.6	<p>Page 3: The ISL28227 8 LD TDFN Pin configuration: Vout_A and Vout_B labels on pins 1 and 7 changed to VoutA and VoutB Figure 8: labeled red curve $V_s = \pm 5V$ and blue curve $V_s = \pm 15V$.</p> <ul style="list-style-type: none"> -Converted to New Intersil Template -Added AN1509 in Related Literature on page 1 -Removed Titles from Graphics on page 1 and replaced with Figure names -Changed copyright to legal's suggested verbiage on page 1 -Updated Ordering Information table on page 2. Removed Coming Soon for ISL28127FRTBZ and ISL28127FUBZ parts. Added in the Vos (MAX) numbers in those rows (75 and 70 respectively). -Changed Tape and Reel Note in ordering information to "Add T*..." to include all Tape and Reel additions -Updated Electrical Spec Table page 5 and page 6 for Vos and TCvos <ul style="list-style-type: none"> oAdded data row for Offset Voltage; MSOP Grade B Package; ISL28127 oAdded data row for Offset Voltage; TDFN Grade B Package; ISL28127 oAdded data row for Offset Voltage Drift; MSOP Grade B Package; ISL28127 oAdded data row for Offset Voltage Drift; TDFN Grade B Package; ISL28127 oRemoved - Temperature data established by characterization from conditions (New standard note covers this verbiage) oChanged Note: "Parameters with MIN and/or MAX limits are 100% tested at +25°C, unless otherwise specified. Temperature limits established by characterization and are not production tested". TO: Compliance to datasheet limits is assured by one or more methods: production test, characterization and/or design. -Updated Typical Performance Curves <ul style="list-style-type: none"> oUpdated typical plot of Vos vs Temp for Figure 8. oAdded: IB+ vs Temp vs Vsupply plot; IB- vs Temp vs Vsupply plot; Ios vs Temp vs Vsupply plot; Figures 9, 10, 11 Added: Vos distribution Vs=15V plot; Vos distribution Vs=5V plot; TCvos distribution Vs=15V plot; TCvos distribution Vs=5V plot; TCIB+ distribution Vs=15V plot; TCIB+ distribution Vs=5V plot; TCIB- distribution Vs=15V plot; TCIB- distribution Vs=5V plot; TClos distribution Vs=15V plot; TClos distribution Vs=5V plot (Figures 13 thru 22)
September 10, 2010	FN6633.5	<ul style="list-style-type: none"> - Updated ordering information by removing Note 2, which referenced "-T13" tape and reel option and revised Note 1 to include "-T7A" tape and reel option. Removed Note reference next to part numbers and placed under part number in table head indicating that it references all parts. Change shows that all parts now have -T7, -T7A and -T13 tape and reel options.

Revision History

The revision history provided is for informational purposes only and is believed to be accurate, but not warranted. Please go to web to make sure you have the latest Rev. **(Continued)**

REVISION	DATE	CHANGE
July 2, 2010	FN6633.4	<p>In "Ordering Information" on page 2: Removed "Coming Soon" from ISL28127FRTZ, ISL28227FRTBZ, ISL28227FRTZ, ISL28227FUBZ & ISL28227FUZ. Updated the part marking for ISL28127FRTBZ from "127Z" to "8127" Updated the part marking for ISL28127FRTZ from "-C 127Z" to "-C 8127" Updated the part marking for ISL28227FRTBZ from "227Z" to "8227" Updated the part marking for ISL28227FRTZ from "-C 227Z" to "-C 8227" Added V_{OS} of 75μV for ISL28227FRTBZ Added V_{OS} of 75μV for ISL28227FUBZ Added Evaluation Boards ISL28127MSOPEVAL1Z and ISL28227SOICEVAL2Z</p> <p>In Thermal Information table on page 5, for 8 Ld TDFN, corrected Theta J_A note from Note 8 to Note 7.</p> <p>In $V_S \pm 15V$ "Electrical Specifications" table on page 5, added V_{OS} specs for ISL28227 MSOP, TDFN Grade B Packages. Added TCV_{OS} specs for ISL28227 MSOP, TDFN Grade B Packages Changed TYP for "Offset Voltage; MSOP, TDFN Grade C Package" from 10μV to -10μV</p> <p>In $V_S \pm 5V$ "Electrical Specifications" table on page 7 added V_{OS} specs for SOIC ISL28227. Added V_{OS} specs for MSOP, TDFN Grade B and C Packages. Added TCV_{OS} specs for SOIC ISL28227. Added TCV_{OS} specs for MSOP, TDFN Grade B and C Packages</p>
March 11, 2010	FN6633.3	<p>PODs M8.118 and L8.3x3A - Updated to new intersil format by adding land pattern and moving dimensions from table onto drawing.</p> <p>On page 2: Under "Ordering Information" ISL28227FBZ: Changed V_{OS} max from 80μV to 75μV</p> <p>On page 5: Changed: 1. ISL28227 SOIC Room Temp limit for V_{OS} from 80μV (MAX) and -80μV (MIN) to 75μV (MAX) and -75μV (MIN). 2. ISL28227 SOIC Full Temp limit for V_{OS} from 160μV (MAX) and -160μV (MIN) to 150μV (MAX) and -150μV (MIN) 3. ISL28227 SOIC limit for TCV_{OS} from 0.8μV (MAX) and -0.8μV (MIN) to 0.75μV (MAX) and -0.75μV (MIN)</p>

Revision History

The revision history provided is for informational purposes only and is believed to be accurate, but not warranted. Please go to web to make sure you have the latest Rev. **(Continued)**

REVISION	DATE	CHANGE																																					
March 11, 2010 (Continued)	FN6633.3 (Continued)	In "Absolute Maximum Ratings" on page 6, HBM for ISL28227 changed from "4kV" to "6kV" In "Thermal Information" on page 6, Tjc values for ISL28227 changed: For MSOP from "50" to "45" For SOIC from "60" to "55"																																					
		<p>In the "Ordering Information" (page 2):</p> <table border="1"> <thead> <tr> <th>Part Number</th> <th>Part Marking</th> <th>Vos (Max) (uV)</th> </tr> </thead> <tbody> <tr> <td>ISL28127FRTBZ</td> <td></td> <td>TBD instead of 70</td> </tr> <tr> <td>ISL28127FRTZ</td> <td>-C 127Z instead of 127Z C</td> <td></td> </tr> <tr> <td>ISL28127FUBZ</td> <td></td> <td>TBD instead of 70</td> </tr> <tr> <td>ISL28127FUZ</td> <td>8127Z -C instead of 8127Z</td> <td>150 instead of 70</td> </tr> <tr> <td colspan="3">Removed "Coming Soon) for ISL28127FUZ package</td> </tr> <tr> <td>ISL28227FBZ</td> <td></td> <td>80 instead of 70</td> </tr> <tr> <td colspan="3">Removed "Coming Soon) for ISL28227FBZ package</td> </tr> <tr> <td>ISL28227FRTBZ</td> <td></td> <td>TBD instead of 70</td> </tr> <tr> <td>ISL28227FRTZ</td> <td>-C 227Z instead of 227Z C</td> <td></td> </tr> <tr> <td>ISL28227FUZ</td> <td>8227Z -C instead of 8227Z</td> <td>150 instead of 70</td> </tr> </tbody> </table> <p>Added the following row of data</p> <table border="1"> <thead> <tr> <th>Part Number</th> <th>Part Marking</th> <th>Vos (Max) (uV)</th> </tr> </thead> <tbody> <tr> <td>ISL28227FUBZ</td> <td>8227Z</td> <td>TBD</td> </tr> </tbody> </table> <p>In the "Electrical specifications" on page 6 and page 8 the following changes were made. The change applies to the same spec found on page 4 and page 6.</p> <p>VOS Offset Voltage; SOIC Package, ISL28127: Added -70 to MIN across room temp and -120 MIN across full temp VOS Offset Voltage; SOIC Package, ISL28227: Added -80 to MIN across room temp and -160 MIN across full temp VOS Offset Voltage; MSOP and TDFN Package Grade C, ISL28127/ISL28227: Added -150 to MIN across room temp and -250 MIN across full temp TCVOS Offset Voltage Drift; SOIC Package, ISL28127: Added -0.5 to MIN across full temp TCVOS Offset Voltage Drift; SOIC Package, ISL28227: Added -0.8 to MIN across full temp TCVOS Offset Voltage Drift; MSOP and TDFN Package Grade C, ISL28127/ISL28227: Added -1 to MIN across full temp IOS Input Offset Current: Added -10 to MIN across room temp and -12 to MIN across full temp IB Input Bias Current: Added -10 to MIN across room temp and -12 to MIN across full temp</p> <p>In the "Ordering Information" (page 3), added differentiated part numbers for B-grade and C-grade for TDFN and MSOP. In "Absolute Maximum Ratings" on page 6, added ESD and latch-up information. In "Thermal Information" on page 6, broke out Theta JA to list the single and dual and added Theta JC.</p>	Part Number	Part Marking	Vos (Max) (uV)	ISL28127FRTBZ		TBD instead of 70	ISL28127FRTZ	-C 127Z instead of 127Z C		ISL28127FUBZ		TBD instead of 70	ISL28127FUZ	8127Z -C instead of 8127Z	150 instead of 70	Removed "Coming Soon) for ISL28127FUZ package			ISL28227FBZ		80 instead of 70	Removed "Coming Soon) for ISL28227FBZ package			ISL28227FRTBZ		TBD instead of 70	ISL28227FRTZ	-C 227Z instead of 227Z C		ISL28227FUZ	8227Z -C instead of 8227Z	150 instead of 70	Part Number	Part Marking	Vos (Max) (uV)	ISL28227FUBZ
Part Number	Part Marking	Vos (Max) (uV)																																					
ISL28127FRTBZ		TBD instead of 70																																					
ISL28127FRTZ	-C 127Z instead of 127Z C																																						
ISL28127FUBZ		TBD instead of 70																																					
ISL28127FUZ	8127Z -C instead of 8127Z	150 instead of 70																																					
Removed "Coming Soon) for ISL28127FUZ package																																							
ISL28227FBZ		80 instead of 70																																					
Removed "Coming Soon) for ISL28227FBZ package																																							
ISL28227FRTBZ		TBD instead of 70																																					
ISL28227FRTZ	-C 227Z instead of 227Z C																																						
ISL28227FUZ	8227Z -C instead of 8227Z	150 instead of 70																																					
Part Number	Part Marking	Vos (Max) (uV)																																					
ISL28227FUBZ	8227Z	TBD																																					

© Copyright Intersil Americas LLC 2009-2016. All Rights Reserved.
All trademarks and registered trademarks are the property of their respective owners.

For additional products, see www.intersil.com/en/products.html

Intersil products are manufactured, assembled and tested utilizing ISO9001 quality systems as noted in the quality certifications found at www.intersil.com/en/support/qualandreliability.html

Intersil products are sold by description only. Intersil may modify the circuit design and/or specifications of products at any time without notice, provided that such modification does not, in Intersil's sole judgment, affect the form, fit or function of the product. Accordingly, the reader is cautioned to verify that datasheets are current before placing orders. Information furnished by Intersil is believed to be accurate and reliable. However, no responsibility is assumed by Intersil or its subsidiaries for its use; nor for any infringements of patents or other rights of third parties which may result from its use. No license is granted by implication or otherwise under any patent or patent rights of Intersil or its subsidiaries.

For information regarding Intersil Corporation and its products, see www.intersil.com

Revision History

The revision history provided is for informational purposes only and is believed to be accurate, but not warranted. Please go to web to make sure you have the latest Rev. **(Continued)**

REVISION	DATE	CHANGE
January 29, 2010	FN6633.2	<p>Added license statement for P-Spice Model.</p> <p>Updated Spice Schematic by adding capacitors C4, C5 and C6</p> <p>Updated Spice Net List as follows:</p> <p>From: Revision B, July 23 2009</p> <p>To: Revision C, August 8th 2009 LaFontaine</p> <p>From: source ISL28127_SPICEMODEL_7_9</p> <p>To: source ISL28127_SPICEMODEL_0_0</p> <p>Added after I_IOS: C_C6 IN+ VIN- 2E-12</p> <p>Added after R_R4: C_C4 VIN- 0 2.5e-12 C_C5 8 0 2.5e-12</p> <p>From: .ends ISL28127</p> <p>To: .ends ISL28127subckt</p> <p>Replaced POD MDP0027 with M8.15E to match ASYD in Intrepid (no dimension changes; the PODs are the same. The change was to update to the Intersil format, moving dimensions from table onto drawing and adding land pattern)</p>
September 14, 2009	FN6633.1	<p>Functional Description on page 17. Corrected low 1/f noise corner frequency from 3Hz to 5Hz to match Figure 2 on page 1. Corrected high open loop gain from 1400V/mV to 1500V/mV to match "Open-Loop Gain on page 6 spec table.</p> <p>Operating Voltage Range on page 17. Removed following 2 sentences since there are no graphs illustrating common mode voltage sensitivity vs temperature or VOS as a function of supply voltage and temperature: "The input common mode voltage sensitivity to temperature is shown in Figure 3 ($\pm 15V$). Figure 20 shows VOS as a function of supply voltage and temperature with the common mode voltage at 0V for split supply operation."</p> <p>Added Theta J_c in Thermal Information on page 5 for TDFN package.</p> <p>Updated Features to show only key features and updated applications section. Added Typical Application Circuit and performance graph, Updated Ordering Information to match Intrepid and added POD's L8.3x3A and M8.118, also added MSL level as part of new format. Added TDFN pinouts, updated pin descriptions to include TDFN pinouts, Added Theta J_a in Thermal information for TDFN and MSOP packages. Added Revision History and Products Text with device info links. Added SPICE Model with referencing text and Net List.</p>
May 28, 2009	FN6633.0	Techdocs Issued File Number FN6633. Initial release of Datasheet with file number FN6633 making this a Rev 0.

About Intersil

Intersil Corporation is a leading provider of innovative power management and precision analog solutions. The company's products address some of the largest markets within the industrial and infrastructure, mobile computing and high-end consumer markets.

For the most updated datasheet, application notes, related documentation and related parts, please see the respective product information page found at www.intersil.com.

You may report errors or suggestions for improving this datasheet by visiting www.intersil.com/ask.

Reliability reports are also available from our website at www.intersil.com/support.

Package Outline Drawing

M8.15E

8 LEAD NARROW BODY SMALL OUTLINE PLASTIC PACKAGE

Rev 0, 08/09

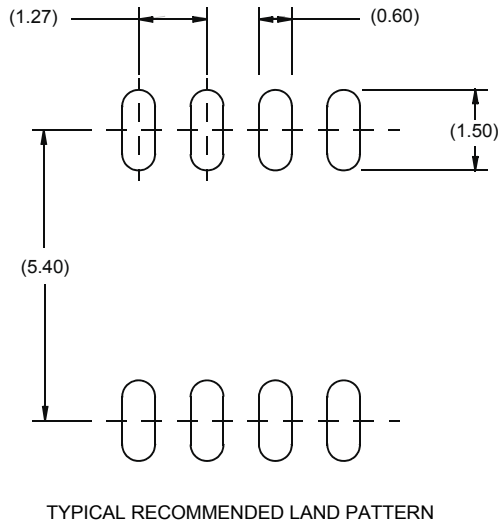
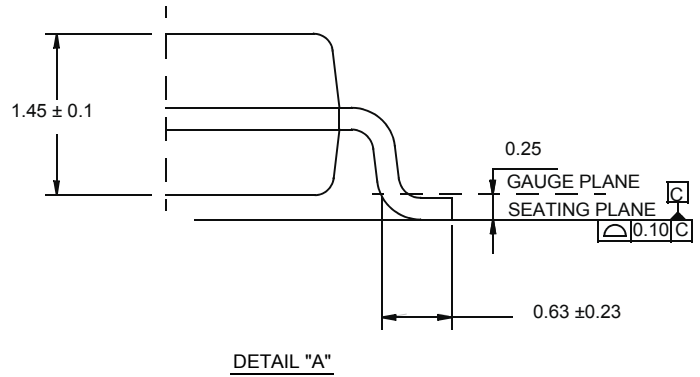
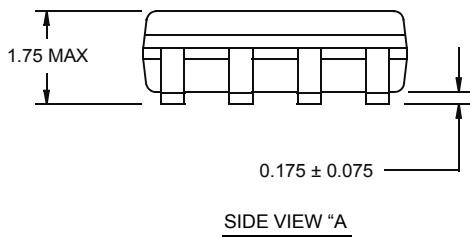
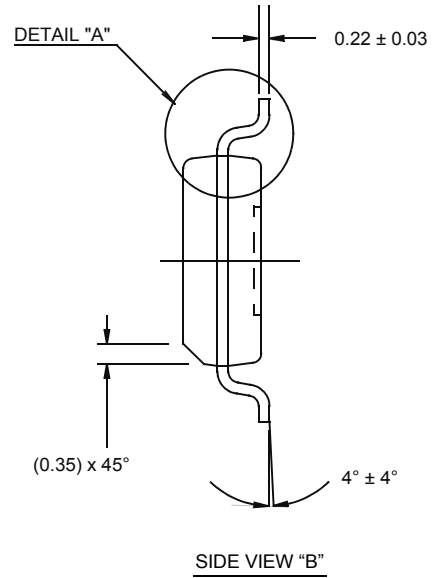
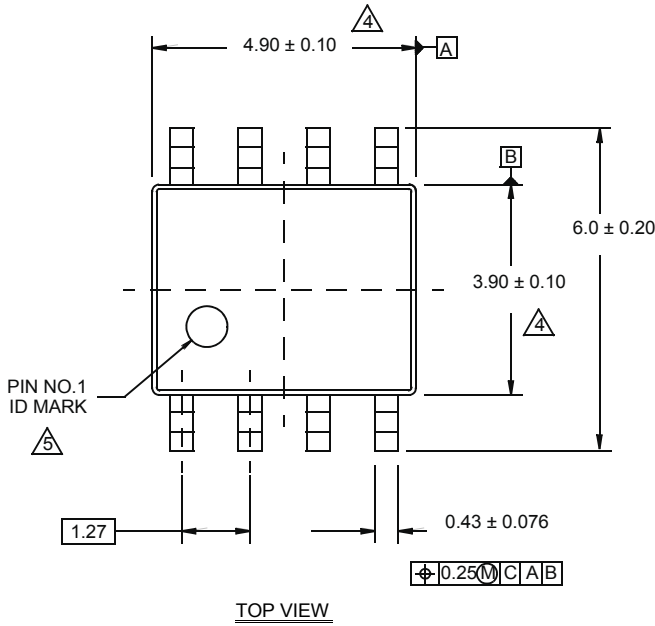

NOTES:

1. Dimensions are in millimeters.
Dimensions in () for Reference Only.
2. Dimensioning and tolerancing conform to AMSE Y14.5m-1994.
3. Unless otherwise specified, tolerance : Decimal ± 0.05
4. Dimension does not include interlead flash or protrusions.
Interlead flash or protrusions shall not exceed 0.25mm per side.
5. The pin #1 identifier may be either a mold or mark feature.
6. Reference to JEDEC MS-012.

Package Outline Drawing

L8.3x3K

8 LEAD THIN DUAL FLAT NO-LEAD PLASTIC PACKAGE

Rev 2, 5/15

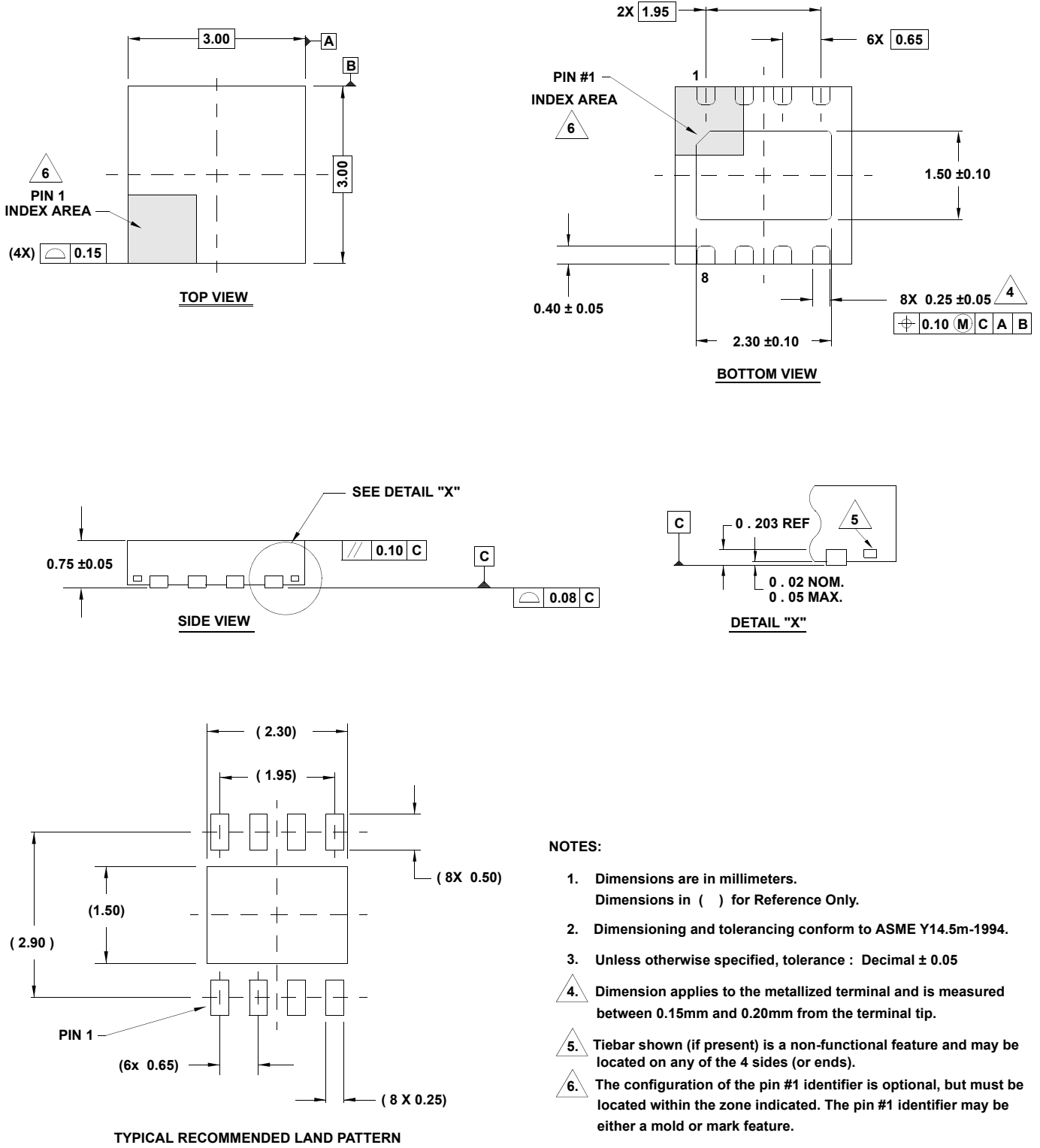

- NOTES:**
1. Dimensions are in millimeters.
Dimensions in () for Reference Only.
 2. Dimensioning and tolerancing conform to ASME Y14.5m-1994.
 3. Unless otherwise specified, tolerance : Decimal ± 0.05
 4. Dimension applies to the metallized terminal and is measured between 0.15mm and 0.20mm from the terminal tip.
 5. Tiebar shown (if present) is a non-functional feature and may be located on any of the 4 sides (or ends).
 6. The configuration of the pin #1 identifier is optional, but must be located within the zone indicated. The pin #1 identifier may be either a mold or mark feature.
 7. Compliant to JEDEC MO-229 WEEC-2 except for the foot length.

Package Outline Drawing

M8.118B

8 LEAD MINI SMALL OUTLINE PLASTIC PACKAGE

Rev 1, 3/12

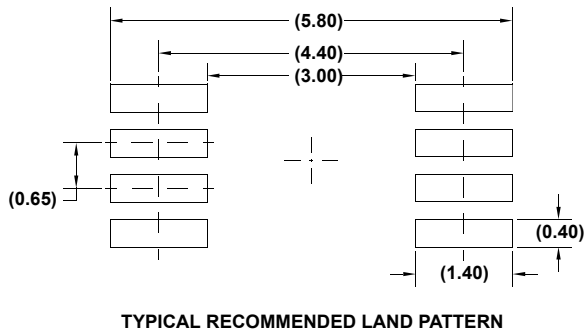
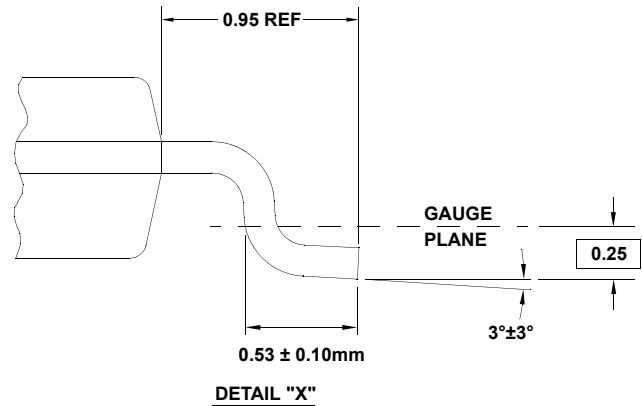
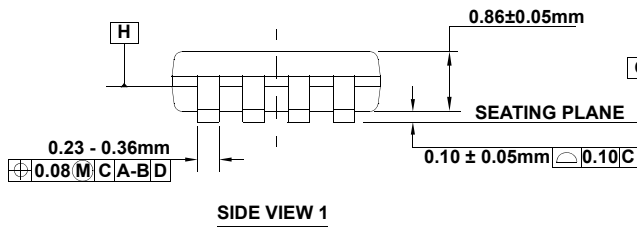
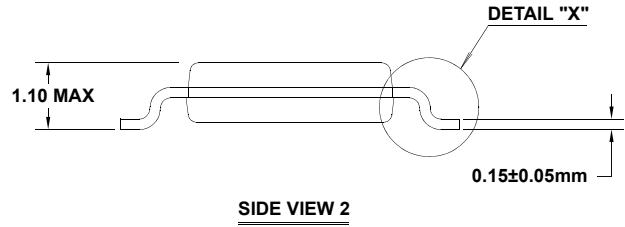
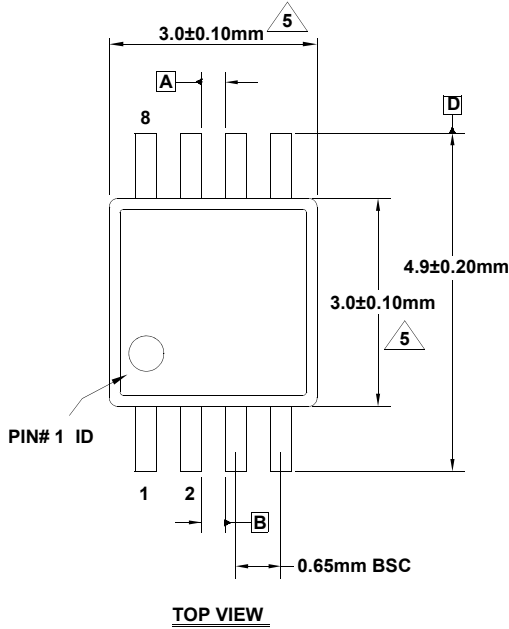

NOTES:

1. Dimensions are in millimeters.
2. Dimensioning and tolerancing conform to JEDEC MO-187-AA and AMSEY14.5m-1994.
3. Plastic or metal protrusions of 0.15mm max per side are not included.
4. Plastic interlead protrusions of 0.15mm max per side are not included.
5. Dimensions are measured at Datum Plane "H".
6. Dimensions in () are for reference only.

Ceramic Metal Seal Flatpack Packages (Flatpack)

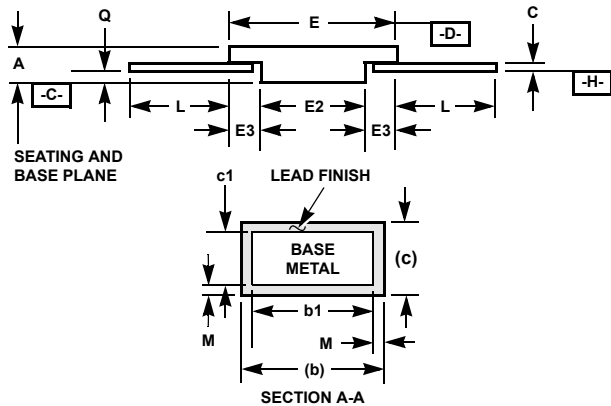
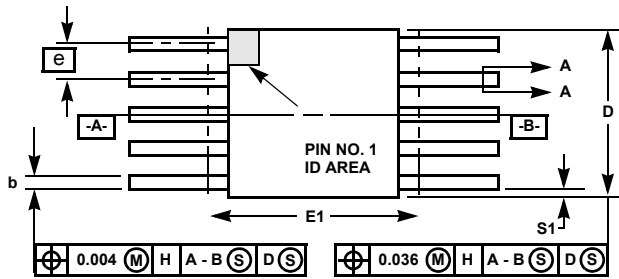

K10.A

MIL-STD-1835 CDFP3-F10 (F-4A, CONFIGURATION B)
10 LEAD CERAMIC METAL SEAL FLATPACK PACKAGE

SYMBOL	INCHES		MILLIMETERS		NOTES
	MIN	MAX	MIN	MAX	
A	0.045	0.115	1.14	2.92	-
b	0.015	0.022	0.38	0.56	-
b1	0.015	0.019	0.38	0.48	-
c	0.004	0.009	0.10	0.23	-
c1	0.004	0.006	0.10	0.15	-
D	-	0.290	-	7.37	3
E	0.240	0.260	6.10	6.60	-
E1	-	0.280	-	7.11	3
E2	0.125	-	3.18	-	-
E3	0.030	-	0.76	-	7
e	0.050 BSC		1.27 BSC		-
k	0.008	0.015	0.20	0.38	2
L	0.250	0.370	6.35	9.40	-
Q	0.026	0.045	0.66	1.14	8
S1	0.005	-	0.13	-	6
M	-	0.0015	-	0.04	-
N	10		10		-

Rev. 0 3/07

NOTES:

1. Index area: A notch or a pin one identification mark shall be located adjacent to pin one and shall be located within the shaded area shown. The manufacturer's identification shall not be used as a pin one identification mark. Alternately, a tab (dimension k) may be used to identify pin one.
2. If a pin one identification mark is used in addition to a tab, the limits of dimension k do not apply.
3. This dimension allows for off-center lid, meniscus, and glass overrun.
4. Dimensions b1 and c1 apply to lead base metal only. Dimension M applies to lead plating and finish thickness. The maximum limits of lead dimensions b and c or M shall be measured at the centroid of the finished lead surfaces, when solder dip or tin plate lead finish is applied.
5. N is the maximum number of terminal positions.
6. Measure dimension S1 at all four corners.
7. For bottom-brazed lead packages, no organic or polymeric materials shall be molded to the bottom of the package to cover the leads.
8. Dimension Q shall be measured at the point of exit (beyond the meniscus) of the lead from the body. Dimension Q minimum shall be reduced by 0.0015 inch (0.038mm) maximum when solder dip lead finish is applied.
9. Dimensioning and tolerancing per ANSI Y14.5M - 1982.
10. Controlling dimension: INCH.

Looking for pricing, stock, or lifecycle information?

Click below to explore more details on WIN SOURCE:

 [View ISL28227FUBZ-T7A on WIN SOURCE](#)

 [Intersil Information](#)

Optimize Your Supply Chain with WIN SOURCE Solutions

-  Global Sourcing Solution
-  Obsolete Management
-  Cost Control Management
-  Shortage Management
-  Alternative Solution
-  Excess Inventory Management