



**THE DATASHEET OF  
LT6200CS6#TRPBF**



# 165MHz, Rail-to-Rail Input and Output, 0.95nV/ $\sqrt{\text{Hz}}$ Low Noise, Op Amp Family

## FEATURES

- **Low Noise Voltage: 0.95nV/ $\sqrt{\text{Hz}}$  (100kHz)**
- **Gain Bandwidth Product:**

|               |        |               |
|---------------|--------|---------------|
| LT6200/LT6201 | 165MHz | $A_V = 1$     |
| LT6200-5      | 800MHz | $A_V \geq 5$  |
| LT6200-10     | 1.6GHz | $A_V \geq 10$ |
- **Low Distortion: -80dB at 1MHz,  $R_L = 100\Omega$**
- **Dual LT6201 in Tiny DFN Package**
- **Input Common Mode Range Includes Both Rails**
- **Output Swings Rail-to-Rail**
- **Low Offset Voltage: 1mV Max**
- **Wide Supply Range: 2.5V to 12.6V**
- **Output Current: 60mA Min**
- **Operating Temperature Range -40°C to 85°C**
- **Power Shutdown, Thermal Shutdown**
- **SO-8 and Low Profile (1mm) ThinSOT™ Packages**

## APPLICATIONS

- Transimpedance Amplifiers
- Low Noise Signal Processing
- Active Filters
- Rail-to-Rail Buffer Amplifiers
- Driving A/D Converters

## DESCRIPTION

The LT®6200/LT6201 are single and dual ultralow noise, rail-to-rail input and output unity gain stable op amps that feature 0.95nV/ $\sqrt{\text{Hz}}$  noise voltage. These amplifiers combine very low noise with a 165MHz gain bandwidth, 50V/ $\mu\text{s}$  slew rate and are optimized for low voltage signal conditioning systems. A shutdown pin reduces supply current during standby conditions and thermal shutdown protects the part from overload conditions.

The LT6200-5/LT6200-10 are single amplifiers optimized for higher gain applications resulting in higher gain bandwidth and slew rate. The LT6200 family maintains its performance for supplies from 2.5V to 12.6V and are specified at 3V, 5V and  $\pm 5\text{V}$ .

For compact layouts the LT6200/LT6200-5/LT6200-10 are available in the 6-lead ThinSOT™ and the 8-pin SO package. The dual LT6201 is available in an 8-pin SO package with standard pinouts as well as a tiny, dual fine pitch leadless package (DFN). These amplifiers can be used as plug-in replacements for many high speed op amps to improve input/output range and noise performance.

LT, LT, LTC, LTM, Linear Technology and the Linear logo are registered trademarks and ThinSOT is a trademark of Linear Technology Corporation. All other trademarks are the property of their respective owners.

## TYPICAL APPLICATION

Single Supply, 1.5nV/ $\sqrt{\text{Hz}}$ , Photodiode Amplifier

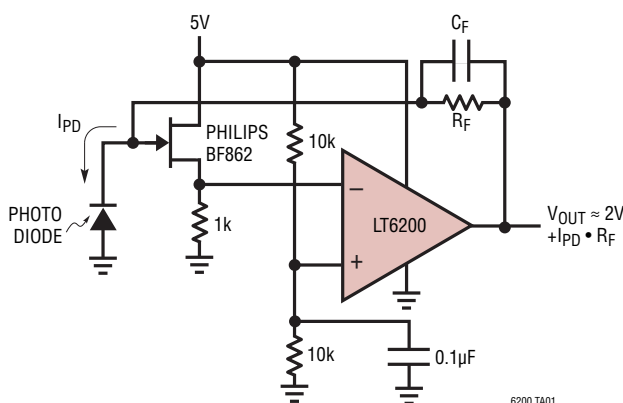

6200 TA01

Distortion vs Frequency

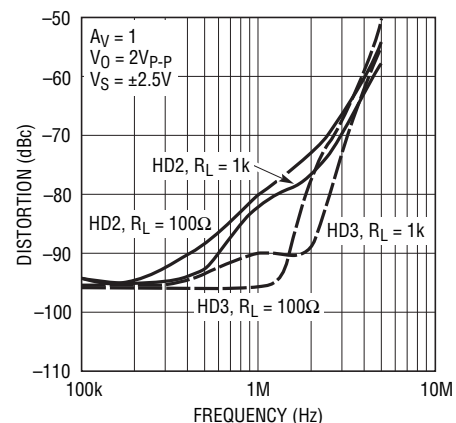

6200 G35

62001ff

# LT6200/LT6200-5 LT6200-10/LT6201

## ABSOLUTE MAXIMUM RATINGS (Note 1)

Total Supply Voltage ( $V^+$  to  $V^-$ ) ..... 12.6V  
 Total Supply Voltage ( $V^+$  to  $V^-$ ) (LT6201DD) ..... 7V  
 Input Current (Note 2).....  $\pm 40\text{mA}$   
 Output Short-Circuit Duration (Note 3) ..... Indefinite  
 Pin Current While Exceeding Supplies  
 (Note 12) .....  $\pm 30\text{mA}$   
 Operating Temperature Range (Note 4)....  $-40^\circ\text{C}$  to  $85^\circ\text{C}$

Specified Temperature Range (Note 5) ....  $-40^\circ\text{C}$  to  $85^\circ\text{C}$   
 Junction Temperature .....  $150^\circ\text{C}$   
 Junction Temperature (DD Package).....  $125^\circ\text{C}$   
 Storage Temperature Range.....  $-65^\circ\text{C}$  to  $150^\circ\text{C}$   
 Storage Temperature Range  
 (DD Package).....  $-65^\circ\text{C}$  to  $125^\circ\text{C}$   
 Lead Temperature (Soldering, 10 sec) .....  $300^\circ\text{C}$

## PIN CONFIGURATION

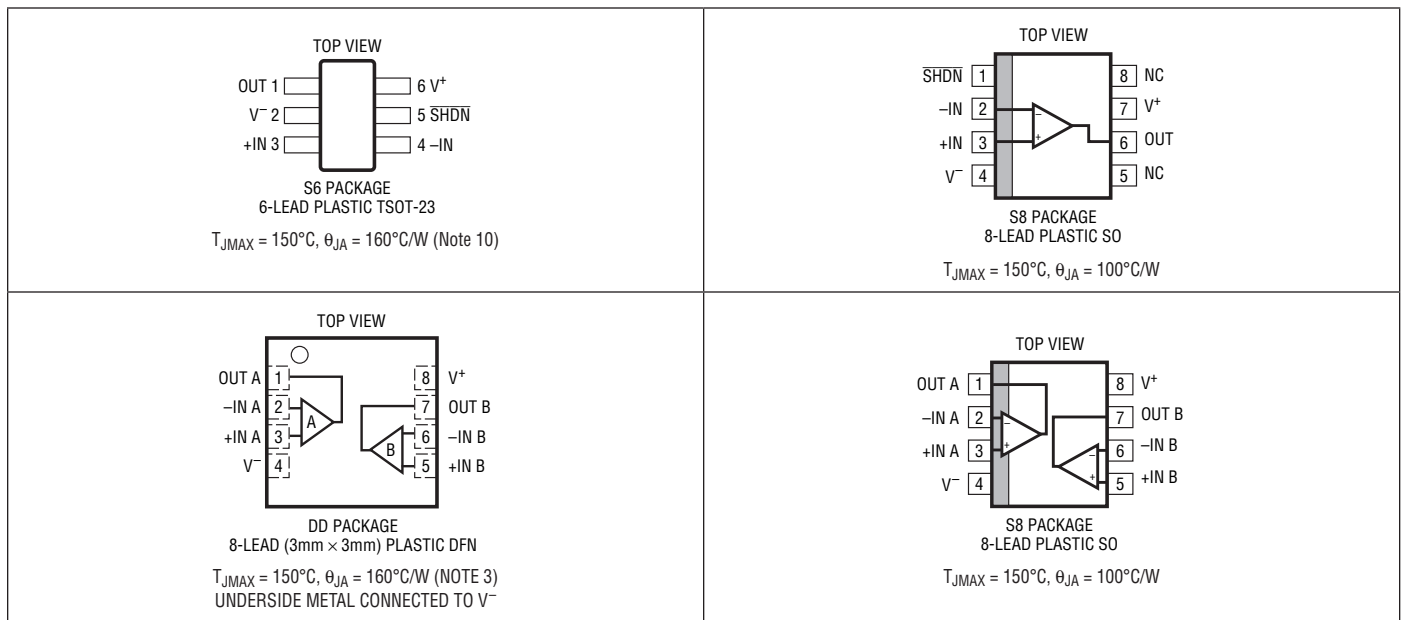

## ORDER INFORMATION

| LEAD FREE FINISH | TAPE AND REEL      | PART MARKING* | PACKAGE DESCRIPTION    | SPECIFIED TEMPERATURE RANGE               |
|------------------|--------------------|---------------|------------------------|---|
| LT6200CS6#PBF    | LT6200CS6#TRPBF    | LTJZ          | 6-Lead Plastic TSOT-23 | $0^\circ\text{C}$ to $70^\circ\text{C}$   |
| LT6200IS6#PBF    | LT6200IS6#TRPBF    | LTJZ          | 6-Lead Plastic TSOT-23 | $-40^\circ\text{C}$ to $85^\circ\text{C}$ |
| LT6200CS6-5#PBF  | LT6200CS6-5#TRPBF  | LTACB         | 6-Lead Plastic TSOT-23 | $0^\circ\text{C}$ to $70^\circ\text{C}$   |
| LT6200IS6-5#PBF  | LT6200IS6-5#TRPBF  | LTACB         | 6-Lead Plastic TSOT-23 | $-40^\circ\text{C}$ to $85^\circ\text{C}$ |
| LT6200CS6-10#PBF | LT6200CS6-10#TRPBF | LTACC         | 6-Lead Plastic TSOT-23 | $0^\circ\text{C}$ to $70^\circ\text{C}$   |
| LT6200IS6-10#PBF | LT6200IS6-10#TRPBF | LTACC         | 6-Lead Plastic TSOT-23 | $-40^\circ\text{C}$ to $85^\circ\text{C}$ |
| LT6200CS8#PBF    | LT6200CS8#TRPBF    | 6200          | 8-Lead Plastic SO      | $0^\circ\text{C}$ to $70^\circ\text{C}$   |
| LT6200IS8#PBF    | LT6200IS8#TRPBF    | 6200I         | 8-Lead Plastic SO      | $-40^\circ\text{C}$ to $85^\circ\text{C}$ |
| LT6200CS8-5#PBF  | LT6200CS8-5#TRPBF  | 62005         | 8-Lead Plastic SO      | $0^\circ\text{C}$ to $70^\circ\text{C}$   |
| LT6200IS8-5#PBF  | LT6200IS8-5#TRPBF  | 6200I5        | 8-Lead Plastic SO      | $-40^\circ\text{C}$ to $85^\circ\text{C}$ |

62001ff

## ORDER INFORMATION

| LEAD FREE FINISH | TAPE AND REEL      | PART MARKING* | PACKAGE DESCRIPTION            | SPECIFIED TEMPERATURE RANGE |
|------------------|--------------------|---------------|--------------------------------|-----------------------------|
| LT6200CS8-10#PBF | LT6200CS8-10#TRPBF | 620010        | 8-Lead Plastic SO              | 0°C to 70°C                 |
| LT6200IS8-10#PBF | LT6200IS8-10#TRPBF | 200110        | 8-Lead Plastic SO              | -40°C to 85°C               |
| LT6201CDD#PBF    | LT6201CDD #TRPBF   | LADG          | 8-Lead (3mm × 3mm) Plastic DFN | 0°C to 70°C                 |
| LT6201CS8#PBF    | LT6201CS8 #TRPBF   | 6201          | 8-Lead Plastic SO              | 0°C to 70°C                 |
| LT6201IS8 #PBF   | LT6201IS8 #TRPBF   | 62011         | 8-Lead Plastic SO              | -40°C to 85°C               |

Consult LTC Marketing for parts specified with wider operating temperature ranges. \*The temperature grade is identified by a label on the shipping container. Consult LTC Marketing for information on non-standard lead based finish parts.

For more information on lead free part marking, go to: <http://www.linear.com/leadfree/>

For more information on tape and reel specifications, go to: <http://www.linear.com/tapeandreeel/>

## ELECTRICAL CHARACTERISTICS $T_A = 25^\circ\text{C}$ , $V_S = 5\text{V}$ , $0\text{V}$ ; $V_S = 3\text{V}$ , $0\text{V}$ ; $V_{CM} = V_{OUT} = \text{half supply}$ , $V_{SHDN} = \text{OPEN}$ , unless otherwise noted.

| SYMBOL       | PARAMETER   | CONDITIONS  | MIN | TYP  | MAX | UNITS                  |
|--------------|---|---|-----|------|-----|------------------------|
| $V_{OS}$     | Input Offset Voltage  | $V_S = 5\text{V}$ , $V_{CM} = \text{Half Supply}$   |     | 0.1  | 1   | mV                     |
|              |   | $V_S = 3\text{V}$ , $V_{CM} = \text{Half Supply}$   |     | 0.9  | 2.5 | mV                     |
|              | Input Offset Voltage Match (Channel-to-Channel) (Note 11)         | $V_{CM} = \text{Half Supply}$   |     | 0.2  | 1.1 | mV                     |
|              |   | $V_{CM} = V^- \text{ to } V^+$  |     | 0.5  | 2.2 | mV                     |
| $I_B$        | Input Bias Current  | $V_{CM} = \text{Half Supply}$   | -40 | -10  |     | $\mu\text{A}$          |
|              |   | $V_{CM} = V^+$  |     | 8    | 18  | $\mu\text{A}$          |
|              |   | $V_{CM} = V^-$  | -50 | -23  |     | $\mu\text{A}$          |
| $\Delta I_B$ | $I_B$ Shift   | $V_{CM} = V^- \text{ to } V^+$  |     | 31   | 68  | $\mu\text{A}$          |
|              | $I_B$ Match (Channel-to-Channel) (Note 11)                        | $V_{CM} = V^- \text{ to } V^+$  |     | 0.3  | 5   | $\mu\text{A}$          |
| $I_{OS}$     | Input Offset Current  | $V_{CM} = \text{Half Supply}$   |     | 0.1  | 4   | $\mu\text{A}$          |
|              |   | $V_{CM} = V^+$  |     | 0.02 | 4   | $\mu\text{A}$          |
|              |   | $V_{CM} = V^-$  |     | 0.4  | 5   | $\mu\text{A}$          |
|              | Input Noise Voltage   | 0.1Hz to 10Hz   |     | 600  |     | nV <sub>p-p</sub>      |
| $e_n$        | Input Noise Voltage Density                                       | $f = 100\text{kHz}$ , $V_S = 5\text{V}$   |     | 1.1  |     | nV/ $\sqrt{\text{Hz}}$ |
|              |   | $f = 10\text{kHz}$ , $V_S = 5\text{V}$  |     | 1.5  | 2.4 | nV/ $\sqrt{\text{Hz}}$ |
| $i_n$        | Input Noise Current Density, Balanced Source<br>Unbalanced Source | $f = 10\text{kHz}$ , $V_S = 5\text{V}$  |     | 2.2  |     | pA/ $\sqrt{\text{Hz}}$ |
|              |   | $f = 10\text{kHz}$ , $V_S = 5\text{V}$  |     | 3.5  |     | pA/ $\sqrt{\text{Hz}}$ |
|              | Input Resistance  | Common Mode   |     | 0.57 |     | M $\Omega$             |
|              |   | Differential Mode   |     | 2.1  |     | k $\Omega$             |
| $C_{IN}$     | Input Capacitance   | Common Mode   |     | 3.1  |     | pF                     |
|              |   | Differential Mode   |     | 4.2  |     | pF                     |
| $A_{VOL}$    | Large-Signal Gain   | $V_S = 5\text{V}$ , $V_O = 0.5\text{V to } 4.5\text{V}$ , $R_L = 1\text{k to } V_S/2$     | 70  | 120  |     | V/mV                   |
|              |   | $V_S = 5\text{V}$ , $V_O = 1\text{V to } 4\text{V}$ , $R_L = 100\Omega \text{ to } V_S/2$ | 11  | 18   |     | V/mV                   |
|              |   | $V_S = 3\text{V}$ , $V_O = 0.5\text{V to } 2.5\text{V}$ , $R_L = 1\text{k to } V_S/2$     | 17  | 70   |     | V/mV                   |
| CMRR         | Common Mode Rejection Ratio                                       | $V_S = 5\text{V}$ , $V_{CM} = V^- \text{ to } V^+$  | 65  | 90   |     | dB                     |
|              |   | $V_S = 5\text{V}$ , $V_{CM} = 1.5\text{V to } 3.5\text{V}$                                | 85  | 112  |     | dB                     |
|              |   | $V_S = 3\text{V}$ , $V_{CM} = V^- \text{ to } V^+$  | 60  | 85   |     | dB                     |
|              | CMRR Match (Channel-to-Channel) (Note 11)                         | $V_S = 5\text{V}$ , $V_{CM} = 1.5\text{V to } 3.5\text{V}$                                | 80  | 105  |     | dB                     |
| PSRR         | Power Supply Rejection Ratio                                      | $V_S = 2.5\text{V to } 10\text{V}$ , LT6201DD $V_S = 2.5\text{V to } 7\text{V}$           | 60  | 68   |     | dB                     |
|              |   | $V_S = 2.5\text{V to } 10\text{V}$ , LT6201DD $V_S = 2.5\text{V to } 7\text{V}$           | 65  | 100  |     | dB                     |
|              | Minimum Supply Voltage (Note 6)                                   |   | 2.5 |      |     | V                      |

620011f

# LT6200/LT6200-5 LT6200-10/LT6201

## ELECTRICAL CHARACTERISTICS $T_A = 25^\circ\text{C}$ , $V_S = 5\text{V}, 0\text{V}$ ; $V_S = 3\text{V}, 0\text{V}$ ; $V_{CM} = V_{OUT} = \text{half supply}$ , $V_{SHDN} = \text{OPEN}$ , unless otherwise noted.

| SYMBOL     | PARAMETER                             | CONDITIONS   | MIN         | TYP      | MAX | UNITS                  |
|------------|---------------------------------------|--|-------------|----------|-----|------------------------|
| $V_{OL}$   | Output Voltage Swing LOW (Note 7)     | No Load  |             | 9        | 50  | mV                     |
|            |                                       | $I_{SINK} = 5\text{mA}$  |             | 50       | 100 | mV                     |
|            |                                       | $V_S = 5\text{V}, I_{SINK} = 20\text{mA}$  |             | 150      | 290 | mV                     |
|            |                                       | $V_S = 3\text{V}, I_{SINK} = 20\text{mA}$  |             | 160      | 300 | mV                     |
| $V_{OH}$   | Output Voltage Swing HIGH (Note 7)    | No Load  |             | 55       | 110 | mV                     |
|            |                                       | $I_{SOURCE} = 5\text{mA}$  |             | 95       | 190 | mV                     |
|            |                                       | $V_S = 5\text{V}, I_{SOURCE} = 20\text{mA}$  |             | 220      | 400 | mV                     |
|            |                                       | $V_S = 3\text{V}, I_{SOURCE} = 20\text{mA}$  |             | 240      | 450 | mV                     |
| $I_{SC}$   | Short-Circuit Current                 | $V_S = 5\text{V}$  | $\pm 60$    | $\pm 90$ |     | mA                     |
|            |                                       | $V_S = 3\text{V}$  | $\pm 50$    | $\pm 80$ |     | mA                     |
| $I_S$      | Supply Current per Amplifier          | $V_S = 5\text{V}$  |             | 16.5     | 20  | mA                     |
|            |                                       | $V_S = 3\text{V}$  |             | 15       | 18  | mA                     |
|            | Disabled Supply Current per Amplifier | $V_{SHDN} = 0.3\text{V}$   |             | 1.3      | 1.8 | mA                     |
| $I_{SHDN}$ | SHDN Pin Current                      | $V_{SHDN} = 0.3\text{V}$   |             | 200      | 280 | $\mu\text{A}$          |
| $V_L$      | $V_{SHDN}$ Pin Input Voltage LOW      |  |             |          | 0.3 | V                      |
| $V_H$      | $V_{SHDN}$ Pin Input Voltage HIGH     |  | $V^+ - 0.5$ |          |     | V                      |
|            | Shutdown Output Leakage Current       | $V_{SHDN} = 0.3\text{V}$   |             | 0.1      | 75  | $\mu\text{A}$          |
| $t_{ON}$   | Turn-On Time                          | $V_{SHDN} = 0.3\text{V}$ to $4.5\text{V}$ , $R_L = 100\Omega$ , $V_S = 5\text{V}$        |             | 180      |     | ns                     |
| $t_{OFF}$  | Turn-Off Time                         | $V_{SHDN} = 4.5\text{V}$ to $0.3\text{V}$ , $R_L = 100\Omega$ , $V_S = 5\text{V}$        |             | 180      |     | ns                     |
| GBW        | Gain Bandwidth Product                | Frequency = $1\text{MHz}$ , $V_S = 5\text{V}$  |             |          |     |                        |
|            |                                       | LT6200, LT6201   |             | 145      |     | MHz                    |
|            |                                       | LT6200-5   |             | 750      |     | MHz                    |
|            |                                       | LT6200-10  |             | 1450     |     | MHz                    |
| SR         | Slew Rate                             | $V_S = 5\text{V}$ , $A_V = -1$ , $R_L = 1\text{k}$ , $V_O = 4\text{V}$<br>LT6200, LT6201 | 31          | 44       |     | $\text{V}/\mu\text{s}$ |
|            |                                       | $V_S = 5\text{V}$ , $A_V = -10$ , $R_L = 1\text{k}$ , $V_O = 4\text{V}$<br>LT6200-5      |             | 210      |     | $\text{V}/\mu\text{s}$ |
|            |                                       | LT6200-10  |             | 340      |     | $\text{V}/\mu\text{s}$ |
| FPBW       | Full Power Bandwidth (Note 9)         | $V_S = 5\text{V}$ , $V_{OUT} = 3V_{P-P}$ (LT6200)  | 3.28        | 4.66     |     | MHz                    |
| $t_S$      | Settling Time (LT6200, LT6201)        | 0.1%, $V_S = 5\text{V}$ , $V_{STEP} = 2\text{V}$ , $A_V = -1$ , $R_L = 1\text{k}$        |             | 165      |     | ns                     |

The ● denotes the specifications which apply over  $0^\circ\text{C} < T_A < 70^\circ\text{C}$  temperature range.  $V_S = 5\text{V}, 0\text{V}$ ;  $V_S = 3\text{V}, 0\text{V}$ ;  $V_{CM} = V_{OUT} = \text{half supply}$ ,  $V_{SHDN} = \text{OPEN}$ , unless otherwise noted.

| SYMBOL       | PARAMETER   | CONDITIONS  | MIN | TYP  | MAX | UNITS                        |
|--------------|---|---|-----|------|-----|------------------------------|
| $V_{OS}$     | Input Offset Voltage                                      | $V_S = 5\text{V}$ , $V_{CM} = \text{Half Supply}$ | ●   | 0.2  | 1.2 | mV                           |
|              |   | $V_S = 3\text{V}$ , $V_{CM} = \text{Half Supply}$ | ●   | 1    | 2.7 | mV                           |
|              |   | $V_S = 5\text{V}$ , $V_{CM} = V^+$ to $V^-$       | ●   | 0.3  | 3   | mV                           |
|              |   | $V_S = 3\text{V}$ , $V_{CM} = V^+$ to $V^-$       | ●   | 1.5  | 4   | mV                           |
|              | Input Offset Voltage Match (Channel-to-Channel) (Note 11) | $V_{CM} = \text{Half Supply}$                     | ●   | 0.2  | 1.8 | mV                           |
|              |   | $V_{CM} = V^-$ to $V^+$                           | ●   | 0.4  | 2.8 | mV                           |
| $V_{OS\ TC}$ | Input Offset Voltage Drift (Note 8)                       | $V_{CM} = \text{Half Supply}$                     | ●   | 2.5  | 8   | $\mu\text{V}/^\circ\text{C}$ |
| $I_B$        | Input Bias Current  | $V_{CM} = \text{Half Supply}$                     | ●   | -40  | -10 | $\mu\text{A}$                |
|              |   | $V_{CM} = V^+$                                    | ●   |      | 8   | $\mu\text{A}$                |
|              |   | $V_{CM} = V^-$                                    | ●   | -50  | -23 | $\mu\text{A}$                |
|              | $I_B$ Match (Channel-to-Channel) (Note 11)                | $V_{CM} = V^-$ to $V^+$                           | ●   | 0.5  | 6   | $\mu\text{A}$                |
| $\Delta I_B$ | $I_B$ Shift   | $V_{CM} = V^-$ to $V^+$                           | ●   | 31   | 68  | $\mu\text{A}$                |
| $I_{OS}$     | Input Offset Current                                      | $V_{CM} = \text{Half Supply}$                     | ●   | 0.1  | 4   | $\mu\text{A}$                |
|              |   | $V_{CM} = V^+$                                    | ●   | 0.02 | 4   | $\mu\text{A}$                |
|              |   | $V_{CM} = V^-$                                    | ●   | 0.4  | 5   | $\mu\text{A}$                |

62001ff

**ELECTRICAL CHARACTERISTICS** The ● denotes the specifications which apply over 0°C < T<sub>A</sub> < 70°C temperature range. V<sub>S</sub> = 5V, 0V; V<sub>S</sub> = 3V, 0V; V<sub>CM</sub> = V<sub>OUT</sub> = half supply, V<sub>SHDN</sub> = OPEN, unless otherwise noted.

| SYMBOL            | PARAMETER                                 | CONDITIONS   | MIN  | TYP                 | MAX  | UNITS |    |
|-------------------|---|--|--|---------------------|------|-------|----|
| A <sub>VOL</sub>  | Large-Signal Gain                         | V <sub>S</sub> = 5V, V <sub>O</sub> = 0.5V to 4.5V, R <sub>L</sub> = 1k to V <sub>S</sub> /2         | ●  | 46                  | 80   | V/mV  |    |
|                   |   | V <sub>S</sub> = 5V, V <sub>O</sub> = 1.5V to 3.5V, R <sub>L</sub> = 100Ω to V <sub>S</sub> /2       | ●  | 7.5                 | 13   | V/mV  |    |
|                   |   | V <sub>S</sub> = 3V, V <sub>O</sub> = 0.5V to 2.5V, R <sub>L</sub> = 1k to V <sub>S</sub> /2         | ●  | 13                  | 22   | V/mV  |    |
| CMRR              | Common Mode Rejection Ratio               | V <sub>S</sub> = 5V, V <sub>CM</sub> = V <sup>-</sup> to V <sup>+</sup>                              | ●  | 64                  | 88   | dB    |    |
|                   |   | V <sub>S</sub> = 5V, V <sub>CM</sub> = 1.5V to 3.5V  | ●  | 80                  | 105  | dB    |    |
|                   |   | V <sub>S</sub> = 3V, V <sub>CM</sub> = V <sup>-</sup> to V <sup>+</sup>                              | ●  | 60                  | 83   | dB    |    |
|                   | CMRR Match (Channel-to-Channel) (Note 11) | V <sub>S</sub> = 5V, V <sub>CM</sub> = 1.5V to 3.5V  | ●  | 80                  | 105  | dB    |    |
| PSRR              | Power Supply Rejection Ratio              | V <sub>S</sub> = 3V to 10V, LT6201DD V <sub>S</sub> = 3V to 7V                                       | ●  | 60                  | 65   | dB    |    |
|                   |   | PSRR Match (Channel-to-Channel) (Note 11)  | V <sub>S</sub> = 3V to 10V, LT6201DD V <sub>S</sub> = 3V to 7V | ●                   | 60   | 100   | dB |
|                   |   | Minimum Supply Voltage (Note 6)  | ●  | 3                   |      | V     |    |
| V <sub>OL</sub>   | Output Voltage Swing LOW (Note 7)         | No Load  | ●  |                     | 12   | 60    | mV |
|                   |   | I <sub>SINK</sub> = 5mA  | ●  |                     | 55   | 110   | mV |
|                   |   | V <sub>S</sub> = 5V, I <sub>SINK</sub> = 20mA  | ●  |                     | 170  | 310   | mV |
|                   |   | V <sub>S</sub> = 3V, I <sub>SINK</sub> = 20mA  | ●  |                     | 170  | 310   | mV |
| V <sub>OH</sub>   | Output Voltage Swing HIGH (Note 7)        | No Load  | ●  |                     | 65   | 120   | mV |
|                   |   | I <sub>SOURCE</sub> = 5mA  | ●  |                     | 115  | 210   | mV |
|                   |   | V <sub>S</sub> = 5V, I <sub>SOURCE</sub> = 20mA  | ●  |                     | 260  | 440   | mV |
|                   |   | V <sub>S</sub> = 3V, I <sub>SOURCE</sub> = 20mA  | ●  |                     | 270  | 490   | mV |
| I <sub>SC</sub>   | Short-Circuit Current                     | V <sub>S</sub> = 5V  | ●  | ±60                 | ±90  | mA    |    |
|                   |   | V <sub>S</sub> = 3V  | ●  | ±45                 | ±75  | mA    |    |
| I <sub>S</sub>    | Supply Current per Amplifier              | V <sub>S</sub> = 5V  | ●  |                     | 20   | 23    | mA |
|                   |   | V <sub>S</sub> = 3V  | ●  |                     | 19   | 22    | mA |
|                   |   | V <sub>SHDN</sub> = 0.3V   | ●  |                     | 1.35 | 1.8   | mA |
| I <sub>SHDN</sub> | SHDN Pin Current                          | V <sub>SHDN</sub> = 0.3V   | ●  |                     | 215  | 295   | μA |
| V <sub>L</sub>    | V <sub>SHDN</sub> Pin Input Voltage LOW   |  | ●  |                     | 0.3  | V     |    |
| V <sub>H</sub>    | V <sub>SHDN</sub> Pin Input Voltage HIGH  |  | ●  | V <sup>+</sup> -0.5 |      | V     |    |
|                   | Shutdown Output Leakage Current           | V <sub>SHDN</sub> = 0.3V   | ●  |                     | 0.1  | 75    | μA |
| t <sub>ON</sub>   | Turn-On Time                              | V <sub>SHDN</sub> = 0.3V to 4.5V, R <sub>L</sub> = 100Ω, V <sub>S</sub> = 5V                         | ●  |                     | 180  | ns    |    |
| t <sub>OFF</sub>  | Turn-Off Time                             | V <sub>SHDN</sub> = 4.5V to 0.3V, R <sub>L</sub> = 100Ω, V <sub>S</sub> = 5V                         | ●  |                     | 180  | ns    |    |
| SR                | Slew Rate                                 | V <sub>S</sub> = 5V, A <sub>V</sub> = -1, R <sub>L</sub> = 1k, V <sub>O</sub> = 4V<br>LT6200, LT6201 | ●  | 29                  | 42   | V/μs  |    |
|                   |   | V <sub>S</sub> = 5V, A <sub>V</sub> = -10, R <sub>L</sub> = 1k, V <sub>O</sub> = 4V<br>LT6200-5      | ●  |                     | 190  | V/μs  |    |
|                   |   | LT6200-10  | ●  |                     | 310  | V/μs  |    |
| FPBW              | Full Power Bandwidth (Note 9)             | V <sub>S</sub> = 5V, V <sub>OUT</sub> = 3V <sub>P-P</sub> (LT6200)                                   | ●  | 3.07                | 4.45 | MHz   |    |

The ● denotes the specifications which apply over -40°C < T<sub>A</sub> < 85°C temperature range. Excludes the LT6201 in the DD package (Note 3). V<sub>S</sub> = 5V, 0V; V<sub>S</sub> = 3V, 0V; V<sub>CM</sub> = V<sub>OUT</sub> = half supply, V<sub>SHDN</sub> = OPEN, unless otherwise noted. (Note 5)

| SYMBOL             | PARAMETER   | CONDITIONS  | MIN | TYP | MAX | UNITS |       |
|--------------------|---|---|-----|-----|-----|-------|-------|
| V <sub>OS</sub>    | Input Offset Voltage                                      | V <sub>S</sub> = 5V, V <sub>CM</sub> = Half Supply                                  | ●   |     | 0.2 | 1.5   | mV    |
|                    |   | V <sub>S</sub> = 3V, V <sub>CM</sub> = Half Supply                                  | ●   |     | 1   | 2.8   | mV    |
|                    |   | V <sub>S</sub> = 5V, V <sub>CM</sub> = V <sup>+</sup> to V <sup>-</sup>             | ●   |     | 0.3 | 3.5   | mV    |
|                    |   | V <sub>S</sub> = 3V, V <sub>CM</sub> = V <sup>+</sup> to V <sup>-</sup>             | ●   |     | 1.5 | 4.3   | mV    |
|                    | Input Offset Voltage Match (Channel-to-Channel) (Note 11) | V <sub>CM</sub> = Half Supply<br>V <sub>CM</sub> = V <sup>-</sup> to V <sup>+</sup> | ●   |     | 0.2 | 2     | mV    |
|                    |   |   | ●   |     | 0.4 | 3     | mV    |
| V <sub>OS</sub> TC | Input Offset Voltage Drift (Note 8)                       | V <sub>CM</sub> = Half Supply   | ●   |     | 2.5 | 8     | μV/°C |
| I <sub>B</sub>     | Input Bias Current  | V <sub>CM</sub> = Half Supply   | ●   | -40 | -10 | μA    |       |
|                    |   | V <sub>CM</sub> = V <sup>+</sup>  | ●   |     | 8   | 18    | μA    |
|                    |   | V <sub>CM</sub> = V <sup>-</sup>  | ●   | -50 | -23 | μA    |       |

62001ff

# LT6200/LT6200-5 LT6200-10/LT6201

**ELECTRICAL CHARACTERISTICS** The ● denotes the specifications which apply over  $-40^{\circ}\text{C} < T_A < 85^{\circ}\text{C}$  temperature range. Excludes the LT6201 in the DD package (Note 3).  $V_S = 5\text{V}, 0\text{V}$ ;  $V_S = 3\text{V}, 0\text{V}$ ;  $V_{\text{CM}} = V_{\text{OUT}} = \text{half supply}$ ,  $V_{\text{SHDN}} = \text{OPEN}$ , unless otherwise noted. (Note 5)

| SYMBOL            | PARAMETER                                  | CONDITIONS  | MIN                              | TYP         | MAX       | UNITS            |    |
|-------------------|--|---|----------------------------------|-------------|-----------|------------------|----|
| $\Delta I_B$      | $I_B$ Shift                                | $V_{\text{CM}} = V^- \text{ to } V^+$   | ●                                | 31          | 68        | $\mu\text{A}$    |    |
|                   | $I_B$ Match (Channel-to-Channel) (Note 11) | $V_{\text{CM}} = V^- \text{ to } V^+$   | ●                                | 1           | 9         | $\mu\text{A}$    |    |
| $I_{\text{OS}}$   | Input Offset Current                       | $V_{\text{CM}} = \text{Half Supply}$  | ●                                | 0.1         | 4         | $\mu\text{A}$    |    |
|                   |  | $V_{\text{CM}} = V^+$   | ●                                | 0.02        | 4         | $\mu\text{A}$    |    |
|                   |  | $V_{\text{CM}} = V^-$   | ●                                | 0.4         | 5         | $\mu\text{A}$    |    |
| $A_{\text{VOL}}$  | Large-Signal Gain                          | $V_S = 5\text{V}, V_O = 0.5\text{V to } 4.5\text{V}, R_L = 1\text{k to } V_S/2$         | ●                                | 40          | 70        | V/mV             |    |
|                   |  | $V_S = 5\text{V}, V_O = 1.5\text{V to } 3.5\text{V}, R_L = 100\Omega \text{ to } V_S/2$ | ●                                | 7.5         | 13        | V/mV             |    |
|                   |  | $V_S = 3\text{V}, V_O = 0.5\text{V to } 2.5\text{V}, R_L = 1\text{k to } V_S/2$         | ●                                | 11          | 20        | V/mV             |    |
| CMRR              | Common Mode Rejection Ratio                | $V_S = 5\text{V}, V_{\text{CM}} = V^- \text{ to } V^+$                                  | ●                                | 60          | 80        | dB               |    |
|                   |  | $V_S = 5\text{V}, V_{\text{CM}} = 1.5\text{V to } 3.5\text{V}$                          | ●                                | 80          | 100       | dB               |    |
|                   |  | $V_S = 3\text{V}, V_{\text{CM}} = V^- \text{ to } V^+$                                  | ●                                | 60          | 80        | dB               |    |
|                   | CMRR Match (Channel-to-Channel) (Note 11)  | $V_S = 5\text{V}, V_{\text{CM}} = 1.5\text{V to } 3.5\text{V}$                          | ●                                | 75          | 105       | dB               |    |
| PSRR              | Power Supply Rejection Ratio               | $V_S = 3\text{V to } 10\text{V}$  | ●                                | 60          | 68        | dB               |    |
|                   |  | PSRR Match (Channel-to-Channel) (Note 11)   | $V_S = 3\text{V to } 10\text{V}$ | ●           | 60        | 100              | dB |
|                   |  | Minimum Supply Voltage (Note 6)   | ●                                | 3           |           | V                |    |
| $V_{\text{OL}}$   | Output Voltage Swing LOW (Note 7)          | No Load   | ●                                | 18          | 70        | mV               |    |
|                   |  | $I_{\text{SINK}} = 5\text{mA}$  | ●                                | 60          | 120       | mV               |    |
|                   |  | $V_S = 5\text{V}, I_{\text{SINK}} = 20\text{mA}$  | ●                                | 170         | 310       | mV               |    |
|                   |  | $V_S = 3\text{V}, I_{\text{SINK}} = 20\text{mA}$  | ●                                | 175         | 315       | mV               |    |
| $V_{\text{OH}}$   | Output Voltage Swing HIGH (Note 7)         | No Load   | ●                                | 65          | 120       | mV               |    |
|                   |  | $I_{\text{SOURCE}} = 5\text{mA}$  | ●                                | 115         | 210       | mV               |    |
|                   |  | $V_S = 5\text{V}, I_{\text{SOURCE}} = 20\text{mA}$                                      | ●                                | 270         | 450       | mV               |    |
|                   |  | $V_S = 3\text{V}, I_{\text{SOURCE}} = 20\text{mA}$                                      | ●                                | 280         | 500       | mV               |    |
| $I_{\text{SC}}$   | Short-Circuit Current                      | $V_S = 5\text{V}$   | ●                                | $\pm 50$    | $\pm 80$  | mA               |    |
|                   |  | $V_S = 3\text{V}$   | ●                                | $\pm 30$    | $\pm 60$  | mA               |    |
| $I_S$             | Supply Current per Amplifier               | $V_S = 5\text{V}$   | ●                                | 22          | 25.3      | mA               |    |
|                   | Disabled Supply Current per Amplifier      | $V_S = 3\text{V}$<br>$V_{\text{SHDN}} = 0.3\text{V}$                                    | ●                                | 20<br>1.4   | 23<br>1.9 | mA<br>mA         |    |
| $I_{\text{SHDN}}$ | SHDN Pin Current                           | $V_{\text{SHDN}} = 0.3\text{V}$   | ●                                | 220         | 300       | $\mu\text{A}$    |    |
| $V_L$             | $V_{\text{SHDN}}$ Pin Input Voltage LOW    |   | ●                                |             | 0.3       | V                |    |
| $V_H$             | $V_{\text{SHDN}}$ Pin Input Voltage HIGH   |   | ●                                | $V^+ - 0.5$ |           | V                |    |
|                   | Shutdown Output Leakage Current            | $V_{\text{SHDN}} = 0.3\text{V}$   | ●                                | 0.1         | 75        | $\mu\text{A}$    |    |
| $t_{\text{ON}}$   | Turn-On Time                               | $V_{\text{SHDN}} = 0.3\text{V to } 4.5\text{V}, R_L = 100\Omega, V_S = 5\text{V}$       | ●                                | 180         |           | ns               |    |
| $t_{\text{OFF}}$  | Turn-Off Time                              | $V_{\text{SHDN}} = 4.5\text{V to } 0.3\text{V}, R_L = 100\Omega, V_S = 5\text{V}$       | ●                                | 180         |           | ns               |    |
| SR                | Slew Rate                                  | $V_S = 5\text{V}, A_V = -1, R_L = 1\text{k}, V_O = 4\text{V}$<br>LT6200, LT6201         | ●                                | 23          | 33        | V/ $\mu\text{s}$ |    |
|                   |  | $V_S = 5\text{V}, A_V = -10, R_L = 1\text{k}, V_O = 4\text{V}$<br>LT6200-5              | ●                                |             | 160       | V/ $\mu\text{s}$ |    |
|                   |  | LT6200-10   | ●                                |             | 260       | V/ $\mu\text{s}$ |    |
| FPBW              | Full Power Bandwidth (Note 9)              | $V_S = 5\text{V}, V_{\text{OUT}} = 3V_{\text{P-P}}$ (LT6200)                            | ●                                | 2.44        | 3.5       | MHz              |    |

$T_A = 25^{\circ}\text{C}$ ,  $V_S = \pm 5\text{V}$ ,  $V_{\text{CM}} = V_{\text{OUT}} = 0\text{V}$ ,  $V_{\text{SHDN}} = \text{OPEN}$ , unless otherwise noted. Excludes the LT6201 in the DD package (Note 3).

| SYMBOL          | PARAMETER   | CONDITIONS                            | MIN | TYP | MAX | UNITS |
|-----------------|---|---------------------------------------|-----|-----|-----|-------|
| $V_{\text{OS}}$ | Input Offset Voltage                                      | $V_{\text{CM}} = \text{Half Supply}$  |     | 1.4 | 4   | mV    |
|                 |   | $V_{\text{CM}} = V^+$                 |     | 2.5 | 6   | mV    |
|                 |   | $V_{\text{CM}} = V^-$                 |     | 2.5 | 6   | mV    |
|                 | Input Offset Voltage Match (Channel-to-Channel) (Note 11) | $V_{\text{CM}} = 0\text{V}$           |     | 0.2 | 1.6 | mV    |
|                 |   | $V_{\text{CM}} = V^- \text{ to } V^+$ |     | 0.4 | 3.2 | mV    |

62001ff

**ELECTRICAL CHARACTERISTICS**  $T_A = 25^\circ\text{C}$ ,  $V_S = \pm 5\text{V}$ ,  $V_{CM} = V_{OUT} = 0\text{V}$ ,  $V_{SHDN} = \text{OPEN}$ , unless otherwise noted.  
Excludes the LT6201 in the DD package (Note 3).

| SYMBOL       | PARAMETER   | CONDITIONS   | MIN                | TYP                | MAX               | UNITS  |
|--------------|---|--|--------------------|--------------------|-------------------|--|
| $I_B$        | Input Bias Current  | $V_{CM} = \text{Half Supply}$<br>$V_{CM} = V^+$<br>$V_{CM} = V^-$  | -40<br>-50         | -10<br>8<br>-23    | 18                | $\mu\text{A}$<br>$\mu\text{A}$<br>$\mu\text{A}$                            |
| $\Delta I_B$ | $I_B$ Shift   | $V_{CM} = V^-$ to $V^+$  |                    | 31                 | 68                | $\mu\text{A}$  |
|              | $I_B$ Match (Channel-to-Channel) (Note 11)                            | $V_{CM} = V^-$ to $V^+$  |                    | 0.2                | 6                 | $\mu\text{A}$  |
| $I_{OS}$     | Input Offset Current  | $V_{CM} = \text{Half Supply}$<br>$V_{CM} = V^+$<br>$V_{CM} = V^-$  |                    | 1.3<br>1<br>3      | 7<br>7<br>12      | $\mu\text{A}$<br>$\mu\text{A}$<br>$\mu\text{A}$                            |
|              | Input Noise Voltage   | 0.1Hz to 10Hz  |                    | 600                |                   | nV <sub>p-p</sub>  |
| $e_n$        | Input Noise Voltage Density   | $f = 100\text{kHz}$<br>$f = 10\text{kHz}$  |                    | 0.95<br>1.4        | 2.3               | $\text{nV}/\sqrt{\text{Hz}}$<br>$\text{nV}/\sqrt{\text{Hz}}$               |
| $i_n$        | Input Noise Current Density, Balanced Source<br>Unbalanced Source     | $f = 10\text{kHz}$<br>$f = 10\text{kHz}$   |                    | 2.2<br>3.5         |                   | $\text{pA}/\sqrt{\text{Hz}}$<br>$\text{pA}/\sqrt{\text{Hz}}$               |
|              | Input Resistance  | Common Mode<br>Differential Mode   |                    | 0.57<br>2.1        |                   | $\text{M}\Omega$<br>$\text{k}\Omega$                                       |
| $C_{IN}$     | Input Capacitance   | Common Mode<br>Differential Mode   |                    | 3.1<br>4.2         |                   | $\text{pF}$<br>$\text{pF}$   |
| $A_{VOL}$    | Large-Signal Gain   | $V_O = \pm 4.5\text{V}$ , $R_L = 1\text{k}$<br>$V_O = \pm 2\text{V}$ , $R_L = 100$   | 115<br>15          | 200<br>26          |                   | $\text{V}/\text{mV}$<br>$\text{V}/\text{mV}$                               |
| CMRR         | Common Mode Rejection Ratio   | $V_{CM} = V^-$ to $V^+$<br>$V_{CM} = -2\text{V}$ to $2\text{V}$  | 68<br>75           | 96<br>100          |                   | $\text{dB}$<br>$\text{dB}$   |
|              | CMRR Match (Channel-to-Channel) (Note 11)                             | $V_{CM} = -2\text{V}$ to $2\text{V}$   | 80                 | 105                |                   | $\text{dB}$  |
| PSRR         | Power Supply Rejection Ratio  | $V_S = \pm 1.25\text{V}$ to $\pm 5\text{V}$  | 60                 | 68                 |                   | $\text{dB}$  |
|              | PSRR Match (Channel-to-Channel) (Note 6)                              | $V_S = \pm 1.25\text{V}$ to $\pm 5\text{V}$  | 65                 | 100                |                   | $\text{dB}$  |
| $V_{OL}$     | Output Voltage Swing LOW (Note 7)                                     | No Load<br>$I_{SINK} = 5\text{mA}$<br>$I_{SINK} = 20\text{mA}$   |                    | 12<br>55<br>150    | 50<br>110<br>290  | $\text{mV}$<br>$\text{mV}$<br>$\text{mV}$                                  |
| $V_{OH}$     | Output Voltage Swing HIGH (Note 7)                                    | No Load<br>$I_{SOURCE} = 5\text{mA}$<br>$I_{SOURCE} = 20\text{mA}$   |                    | 70<br>110<br>225   | 130<br>210<br>420 | $\text{mV}$<br>$\text{mV}$<br>$\text{mV}$                                  |
| $I_{SC}$     | Short-Circuit Current   |  | $\pm 60$           | $\pm 90$           |                   | $\text{mA}$  |
| $I_S$        | Supply Current per Amplifier<br>Disabled Supply Current per Amplifier | $V_{SHDN} = 0.3\text{V}$   |                    | 20<br>1.6          | 23<br>2.1         | $\text{mA}$<br>$\text{mA}$   |
| $I_{SHDN}$   | SHDN Pin Current  | $V_{SHDN} = 0.3\text{V}$   |                    | 200                | 280               | $\mu\text{A}$  |
| $V_L$        | $V_{SHDN}$ Pin Input Voltage LOW                                      |  |                    |                    | 0.3               | $\text{V}$   |
| $V_H$        | $V_{SHDN}$ Pin Input Voltage HIGH                                     |  | $V^+ - 0.5$        |                    |                   | $\text{V}$   |
|              | Shutdown Output Leakage Current                                       | $V_{SHDN} = 0.3\text{V}$   |                    | 0.1                | 75                | $\mu\text{A}$  |
| $t_{ON}$     | Turn-On Time  | $V_{SHDN} = 0.3\text{V}$ to $4.5\text{V}$ , $R_L = 100\Omega$ , $V_S = 5\text{V}$  |                    | 180                |                   | $\text{ns}$  |
| $t_{OFF}$    | Turn-Off Time   | $V_{SHDN} = 4.5\text{V}$ to $0.3\text{V}$ , $R_L = 100\Omega$ , $V_S = 5\text{V}$  |                    | 180                |                   | $\text{ns}$  |
| GBW          | Gain Bandwidth Product  | Frequency = 1MHz<br>LT6200, LT6201<br>LT6200-5<br>LT6200-10  | 110<br>530<br>1060 | 165<br>800<br>1600 |                   | $\text{MHz}$<br>$\text{MHz}$<br>$\text{MHz}$                               |
| SR           | Slew Rate   | $A_V = -1$ , $R_L = 1\text{k}$ , $V_O = 4\text{V}$<br>LT6200, LT6201<br>$A_V = -10$ , $R_L = 1\text{k}$ , $V_O = 4\text{V}$<br>LT6200-5<br>LT6200-10 | 35<br>175<br>315   | 50<br>250<br>450   |                   | $\text{V}/\mu\text{s}$<br>$\text{V}/\mu\text{s}$<br>$\text{V}/\mu\text{s}$ |

# LT6200/LT6200-5 LT6200-10/LT6201

## ELECTRICAL CHARACTERISTICS $T_A = 25^\circ\text{C}$ , $V_S = \pm 5\text{V}$ , $V_{CM} = V_{OUT} = 0\text{V}$ , $V_{SHDN} = \text{OPEN}$ , unless otherwise noted. Excludes the LT6201 in the DD package (Note 3).

| SYMBOL | PARAMETER                     | CONDITIONS                               | MIN | TYP | MAX | UNITS |
|--------|-------------------------------|--|-----|-----|-----|-------|
| FPBW   | Full Power Bandwidth (Note 9) | $V_{OUT} = 3V_{P-P}$ (LT6200-10)         | 33  | 47  |     | MHz   |
| $t_S$  | Setting Time (LT6200, LT6201) | 0.1%, $V_{STEP} = 1$ , $R_L = 1\text{k}$ |     | 140 |     | ns    |

The ● denotes the specifications which apply over  $0^\circ\text{C} < T_A < 70^\circ\text{C}$  temperature range. Excludes the LT6201 in the DD package (Note 3).  $V_S = \pm 5\text{V}$ ,  $V_{CM} = V_{OUT} = 0\text{V}$ ,  $V_{SHDN} = \text{OPEN}$ , unless otherwise noted.

| SYMBOL       | PARAMETER   | CONDITIONS   | MIN | TYP         | MAX      | UNITS                        |
|--------------|---|--|-----|-------------|----------|------------------------------|
| $V_{OS}$     | Input Offset Voltage  | $V_{CM} = \text{Half Supply}$  | ●   | 1.9         | 4.5      | mV                           |
|              |   | $V_{CM} = V^+$   | ●   | 3.5         | 7.5      | mV                           |
|              |   | $V_{CM} = V^-$   | ●   | 3.5         | 7.5      | mV                           |
|              | Input Offset Voltage Match (Channel-to-Channel) (Note 11)             | $V_{CM} = 0\text{V}$   | ●   | 0.2         | 1.8      | mV                           |
|              |   | $V_{CM} = V^- \text{ to } V^+$   | ●   | 0.4         | 3.4      | mV                           |
| $V_{OS\ TC}$ | Input Offset Voltage Drift (Note 8)                                   | $V_{CM} = \text{Half Supply}$  | ●   | 8.2         | 24       | $\mu\text{V}/^\circ\text{C}$ |
| $I_B$        | Input Bias Current  | $V_{CM} = \text{Half Supply}$  | ●   | -40         | -10      | $\mu\text{A}$                |
|              |   | $V_{CM} = V^+$   | ●   |             | 8        | $\mu\text{A}$                |
|              |   | $V_{CM} = V^-$   | ●   | -50         | -23      | $\mu\text{A}$                |
| $\Delta I_B$ | $I_B$ Shift   | $V_{CM} = V^- \text{ to } V^+$   | ●   | 31          | 68       | $\mu\text{A}$                |
|              | $I_B$ Match (Channel-to-Channel) (Note 11)                            | $V_{CM} = V^- \text{ to } V^+$   | ●   | 1           | 9        | $\mu\text{A}$                |
| $I_{OS}$     | Input Offset Current  | $V_{CM} = \text{Half Supply}$  | ●   | 1.3         | 10       | $\mu\text{A}$                |
|              |   | $V_{CM} = V^+$   | ●   | 1           | 10       | $\mu\text{A}$                |
|              |   | $V_{CM} = V^-$   | ●   | 3.5         | 15       | $\mu\text{A}$                |
| $A_{VOL}$    | Large-Signal Gain   | $V_O = \pm 4.5\text{V}$ , $R_L = 1\text{k}$  | ●   | 46          | 80       | V/mV                         |
|              |   | $V_O = \pm 2\text{V}$ , $R_L = 100$  | ●   | 7.5         | 13.5     | V/mV                         |
| CMRR         | Common Mode Rejection Ratio   | $V_{CM} = V^- \text{ to } V^+$   | ●   | 65          | 90       | dB                           |
|              |   | $V_{CM} = -2\text{V} \text{ to } 2\text{V}$  | ●   | 75          | 100      | dB                           |
|              | CMRR Match (Channel-to-Channel) (Note 11)                             | $V_{CM} = -2\text{V} \text{ to } 2\text{V}$  | ●   | 75          | 105      | dB                           |
| PSRR         | Power Supply Rejection Ratio  | $V_S = \pm 1.5\text{V} \text{ to } \pm 5\text{V}$  | ●   | 60          | 65       | dB                           |
|              |   | PSRR Match (Channel-to-Channel) (Note 6)   | ●   | 60          | 100      | dB                           |
| $V_{OL}$     | Output Voltage Swing LOW (Note 7)                                     | No Load  | ●   | 16          | 70       | mV                           |
|              |   | $I_{SINK} = 5\text{mA}$  | ●   | 60          | 120      | mV                           |
|              |   | $I_{SINK} = 20\text{mA}$   | ●   | 170         | 310      | mV                           |
| $V_{OH}$     | Output Voltage Swing HIGH (Note 7)                                    | No Load  | ●   | 85          | 150      | mV                           |
|              |   | $I_{SOURCE} = 5\text{mA}$  | ●   | 125         | 230      | mV                           |
|              |   | $I_{SOURCE} = 20\text{mA}$   | ●   | 265         | 480      | mV                           |
| $I_{SC}$     | Short-Circuit Current   |  | ●   | $\pm 60$    | $\pm 90$ | mA                           |
| $I_S$        | Supply Current per Amplifier<br>Disabled Supply Current per Amplifier | $V_{SHDN} = 0.3\text{V}$   | ●   | 25          | 29       | mA                           |
|              |   |  | ●   | 1.6         | 2.1      | mA                           |
| $I_{SHDN}$   | SHDN Pin Current  | $V_{SHDN} = 0.3\text{V}$   | ●   | 215         | 295      | $\mu\text{A}$                |
| $V_L$        | $V_{SHDN}$ Pin Input Voltage LOW                                      |  | ●   |             | 0.3      | V                            |
| $V_H$        | $V_{SHDN}$ Pin Input Voltage HIGH                                     |  | ●   | $V^+ - 0.5$ |          | V                            |
|              | Shutdown Output Leakage Current                                       | $V_{SHDN} = 0.3\text{V}$   | ●   | 0.1         | 75       | $\mu\text{A}$                |
| $t_{ON}$     | Turn-On Time  | $V_{SHDN} = 0.3\text{V} \text{ to } 4.5\text{V}$ , $R_L = 100\Omega$ , $V_S = 5\text{V}$ | ●   | 180         |          | ns                           |
| $t_{OFF}$    | Turn-Off Time   | $V_{SHDN} = 4.5\text{V} \text{ to } 0.3\text{V}$ , $R_L = 100\Omega$ , $V_S = 5\text{V}$ | ●   | 180         |          | ns                           |
| SR           | Slew Rate   | $A_V = -1$ , $R_L = 1\text{k}$ , $V_O = 4\text{V}$<br>LT6200, LT6201                     | ●   | 31          | 44       | V/ $\mu\text{s}$             |
|              |   | $A_V = -10$ , $R_L = 1\text{k}$ , $V_O = 4\text{V}$<br>LT6200-5<br>LT6200-10             | ●   | 150         | 215      | V/ $\mu\text{s}$             |
|              |   |  | ●   | 290         | 410      | V/ $\mu\text{s}$             |
| FPBW         | Full Power Bandwidth (Note 9)   | $V_{OUT} = 3V_{P-P}$ (LT6200-10)   | ●   | 30          | 43       | MHz                          |

62001ff

**ELECTRICAL CHARACTERISTICS** The ● denotes the specifications which apply over  $-40^{\circ}\text{C} < T_A < 85^{\circ}\text{C}$  temperature range. Excludes the LT6201 in the DD package (Note 3).  $V_S = \pm 5\text{V}$ ,  $V_{\text{CM}} = V_{\text{OUT}} = 0\text{V}$ ,  $V_{\text{SHDN}} = \text{OPEN}$ , unless otherwise noted. (Note 5)

| SYMBOL                | PARAMETER   | CONDITIONS  | MIN | TYP         | MAX      | UNITS                          |
|-----------------------|---|---|-----|-------------|----------|--------------------------------|
| $V_{\text{OS}}$       | Input Offset Voltage                                      | $V_{\text{CM}} = \text{Half Supply}$  | ●   | 1.9         | 4.5      | mV                             |
|                       |   | $V_{\text{CM}} = V^+$   | ●   | 3.5         | 7.5      | mV                             |
|                       |   | $V_{\text{CM}} = V^-$   | ●   | 3.5         | 7.5      | mV                             |
|                       | Input Offset Voltage Match (Channel-to-Channel) (Note 11) | $V_{\text{CM}} = 0\text{V}$   | ●   | 0.2         | 2        | mV                             |
|                       |   | $V_{\text{CM}} = V^- \text{ to } V^+$   | ●   | 0.4         | 3.6      | mV                             |
| $V_{\text{OS TC}}$    | Input Offset Voltage Drift (Note 8)                       | $V_{\text{CM}} = \text{Half Supply}$  | ●   | 8.2         | 24       | $\mu\text{V}/^{\circ}\text{C}$ |
| $I_{\text{B}}$        | Input Bias Current  | $V_{\text{CM}} = \text{Half Supply}$  | ●   | -40         | -10      | $\mu\text{A}$                  |
|                       |   | $V_{\text{CM}} = V^+$   | ●   |             | 8        | $\mu\text{A}$                  |
|                       |   | $V_{\text{CM}} = V^-$   | ●   | -50         | -23      | $\mu\text{A}$                  |
| $\Delta I_{\text{B}}$ | $I_{\text{B}}$ Shift                                      | $V_{\text{CM}} = V^- \text{ to } V^+$   | ●   | 31          | 68       | $\mu\text{A}$                  |
|                       | $I_{\text{B}}$ Match (Channel-to-Channel) (Note 11)       |   | ●   | 4           | 12       | $\mu\text{A}$                  |
| $I_{\text{OS}}$       | Input Offset Current                                      | $V_{\text{CM}} = \text{Half Supply}$  | ●   | 1.3         | 10       | $\mu\text{A}$                  |
|                       |   | $V_{\text{CM}} = V^+$   | ●   | 1           | 10       | $\mu\text{A}$                  |
|                       |   | $V_{\text{CM}} = V^-$   | ●   | 3.5         | 15       | $\mu\text{A}$                  |
| $A_{\text{VOL}}$      | Large-Signal Gain   | $V_{\text{O}} = \pm 4.5\text{V}$ , $R_{\text{L}} = 1\text{k}$   | ●   | 46          | 80       | V/mV                           |
|                       |   | $V_{\text{O}} = \pm 2\text{V}$ , $R_{\text{L}} = 100$   | ●   | 7.5         | 13.5     | V/mV                           |
| CMRR                  | Common Mode Rejection Ratio                               | $V_{\text{CM}} = V^- \text{ to } V^+$   | ●   | 65          | 90       | dB                             |
|                       |   | $V_{\text{CM}} = -2\text{V to } 2\text{V}$  | ●   | 75          | 100      | dB                             |
|                       | CMRR Match (Channel-to-Channel) (Note 11)                 | $V_{\text{CM}} = -2\text{V to } 2\text{V}$  | ●   | 75          | 105      | dB                             |
| PSRR                  | Power Supply Rejection Ratio                              | $V_S = \pm 1.5\text{V to } \pm 5\text{V}$   | ●   | 60          | 65       | dB                             |
|                       |   | PSRR Match (Channel-to-Channel) (Note 6)  | ●   | 60          | 100      | dB                             |
| $V_{\text{OL}}$       | Output Voltage Swing LOW (Note 7)                         | No Load   | ●   | 16          | 75       | mV                             |
|                       |   | $I_{\text{SINK}} = 5\text{mA}$  | ●   | 60          | 125      | mV                             |
|                       |   | $I_{\text{SINK}} = 20\text{mA}$   | ●   | 170         | 310      | mV                             |
| $V_{\text{OH}}$       | Output Voltage Swing HIGH (Note 7)                        | No Load   | ●   | 85          | 150      | mV                             |
|                       |   | $I_{\text{SOURCE}} = 5\text{mA}$  | ●   | 125         | 230      | mV                             |
|                       |   | $I_{\text{SINK}} = 20\text{mA}$   | ●   | 265         | 480      | mV                             |
| $I_{\text{SC}}$       | Short-Circuit Current                                     |   | ●   | $\pm 60$    | $\pm 90$ | mA                             |
| $I_{\text{S}}$        | Supply Current  |   | ●   | 25          | 29       | mA                             |
|                       | Disabled Supply Current                                   | $V_{\text{SHDN}} = 0.3\text{V}$   | ●   | 1.6         | 2.1      | mA                             |
| $I_{\text{SHDN}}$     | SHDN Pin Current  | $V_{\text{SHDN}} = 0.3\text{V}$   | ●   | 215         | 295      | $\mu\text{A}$                  |
| $V_{\text{L}}$        | $V_{\text{SHDN}}$ Pin Input Voltage LOW                   |   | ●   |             | 0.3      | V                              |
| $V_{\text{H}}$        | $V_{\text{SHDN}}$ Pin Input Voltage HIGH                  |   | ●   | $V^+ - 0.5$ |          | V                              |
|                       | Shutdown Output Leakage Current                           | $V_{\text{SHDN}} = 0.3\text{V}$   | ●   | 0.1         | 75       | $\mu\text{A}$                  |
| $t_{\text{ON}}$       | Turn-On Time  | $V_{\text{SHDN}} = 0.3\text{V to } 4.5\text{V}$ , $R_{\text{L}} = 100\Omega$ , $V_S = 5\text{V}$        | ●   | 180         |          | ns                             |
| $t_{\text{OFF}}$      | Turn-Off Time   | $V_{\text{SHDN}} = 4.5\text{V to } 0.3\text{V}$ , $R_{\text{L}} = 100\Omega$ , $V_S = 5\text{V}$        | ●   | 180         |          | ns                             |
| SR                    | Slew Rate   | $A_{\text{V}} = -1$ , $R_{\text{L}} = 1\text{k}$ , $V_{\text{O}} = 4\text{V}$<br>LT6200, LT6201         | ●   | 31          | 44       | V/ $\mu\text{s}$               |
|                       |   | $A_{\text{V}} = -10$ , $R_{\text{L}} = 1\text{k}$ , $V_{\text{O}} = 4\text{V}$<br>LT6200-5<br>LT6200-10 | ●   | 125         | 180      | V/ $\mu\text{s}$               |
|                       |   |   | ●   | 260         | 370      | V/ $\mu\text{s}$               |
| FPBW                  | Full Power Bandwidth (Note 9)                             | $V_{\text{OUT}} = 3\text{V}_{\text{P-P}}$ (LT6200-10)   | ●   | 27          | 39       | MHz                            |

**Note 1:** Stresses beyond those listed under Absolute Maximum Ratings may cause permanent damage to the device. Exposure to any Absolute Maximum Rating condition for extended periods may affect device reliability and lifetime

**Note 2:** Inputs are protected by back-to-back diodes. If the differential input voltage exceeds 0.7V, the input current must be limited to less than 40mA. This parameter is guaranteed to meet specified performance through design and/or characterization. It is not 100% tested.

## ELECTRICAL CHARACTERISTICS

**Note 3:** A heat sink may be required to keep the junction temperature below the absolute maximum rating when the output is shorted indefinitely. The LT6201 in the DD package is limited by power dissipation to  $V_S \leq 5V, 0V$  over the commercial temperature range only.

**Note 4:** The LT6200C/LT6200I and LT6201C/LT6201I are guaranteed functional over the temperature range of  $-40^\circ\text{C}$  and  $85^\circ\text{C}$  (LT6201DD excluded).

**Note 5:** The LT6200C/LT6201C are guaranteed to meet specified performance from  $0^\circ\text{C}$  to  $70^\circ\text{C}$ . The LT6200C/LT6201C are designed, characterized and expected to meet specified performance from  $-40^\circ\text{C}$  to  $85^\circ\text{C}$ , but are not tested or QA sampled at these temperatures. The LT6200I is guaranteed to meet specified performance from  $-40^\circ\text{C}$  to  $85^\circ\text{C}$ .

**Note 6:** Minimum supply voltage is guaranteed by power supply rejection ratio test.

**Note 7:** Output voltage swings are measured between the output and power supply rails.

**Note 8:** This parameter is not 100% tested.

**Note 9:** Full-power bandwidth is calculated from the slew rate:  
 $FPBW = SR/2\pi V_P$

**Note 10:** Thermal resistance varies depending upon the amount of PC board metal attached to the  $V^-$  pin of the device.  $\theta_{JA}$  is specified for a certain amount of 2oz copper metal trace connecting to the  $V^-$  pin as described in the thermal resistance tables in the Application Information section.

**Note 11:** Matching parameters on the LT6201 are the difference between the two amplifiers. CMRR and PSRR match are defined as follows: CMRR and PSRR are measured in  $\mu\text{V/V}$  on the identical amplifiers. The difference is calculated in  $\mu\text{V/V}$ . The result is converted to dB.

**Note 12:** There are reverse biased ESD diodes on all inputs and outputs, as shown in Figure 1. If these pins are forced beyond either supply, unlimited current will flow through these diodes. If the current is transient in nature and limited to less than 30mA, no damage to the device will occur.

## TYPICAL PERFORMANCE CHARACTERISTICS

$V_{OS}$  Distribution,  $V_{CM} = V^+/2$

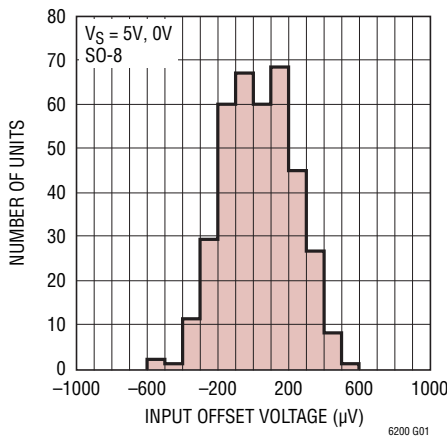

$V_{OS}$  Distribution,  $V_{CM} = V^+$



$V_{OS}$  Distribution,  $V_{CM} = V^-$

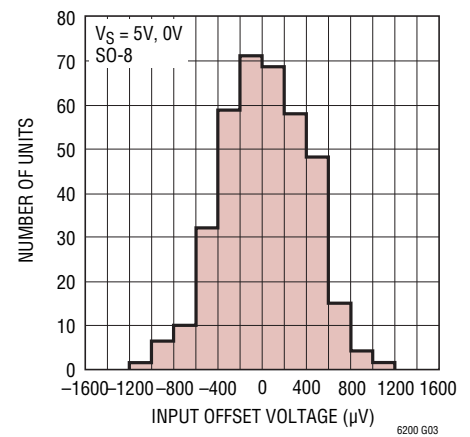

Supply Current vs Supply Voltage

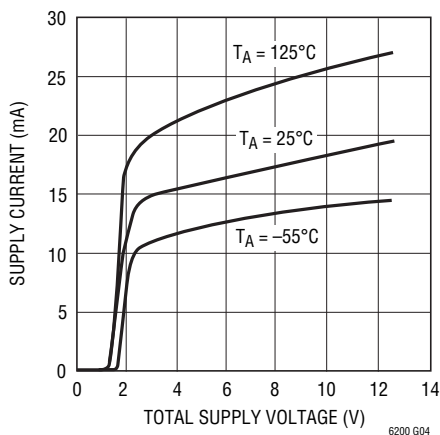

Offset Voltage vs Input Common Mode Voltage

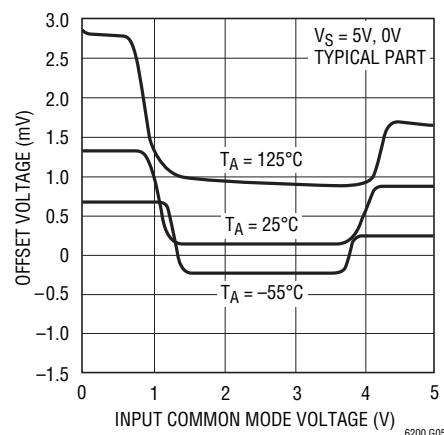

Input Bias Current vs Common Mode Voltage

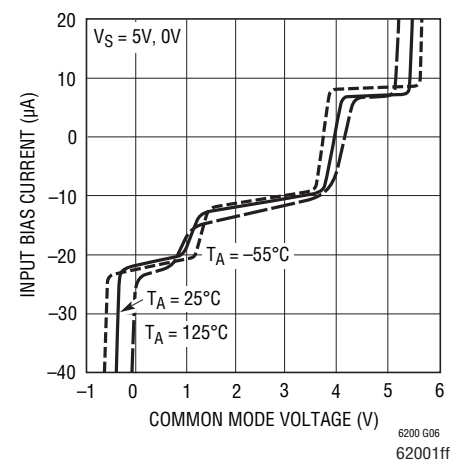

# TYPICAL PERFORMANCE CHARACTERISTICS

**Input Bias Current vs Temperature**



6200 G07

**Output Saturation Voltage vs Load Current (Output Low)**



6200 G08

**Output Saturation Voltage vs Load Current (Output High)**



6200 G09

**Minimum Supply Voltage**

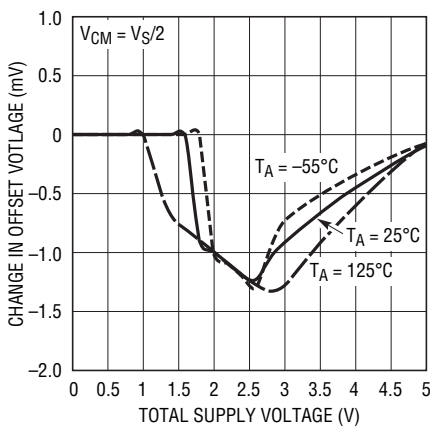

6200 G10

**Output Short-Circuit Current vs Power Supply Voltage**

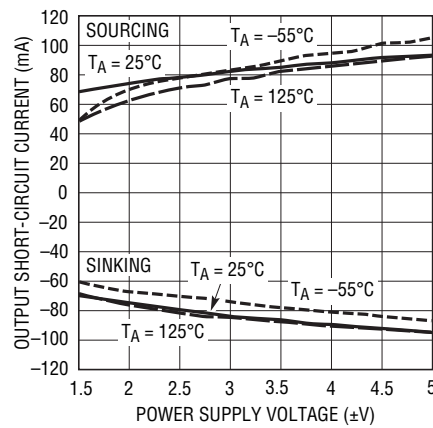

6200 G11

**Open-Loop Gain**

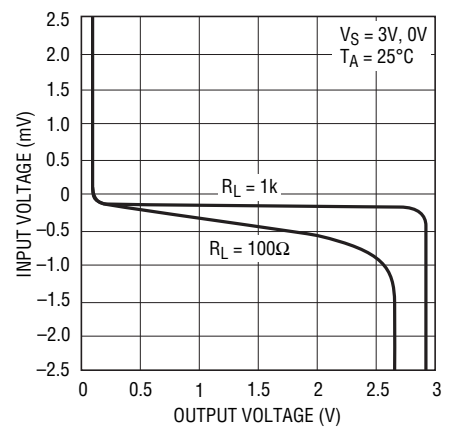

6200 G12

**Open-Loop Gain**

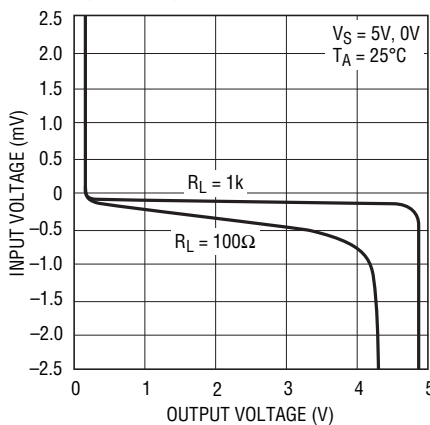

6200 G13

**Open-Loop Gain**

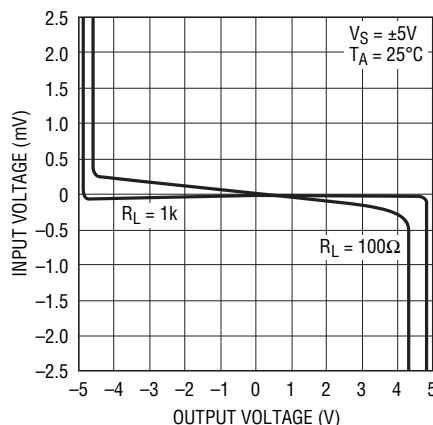

6200 G14

**Offset Voltage vs Output Current**

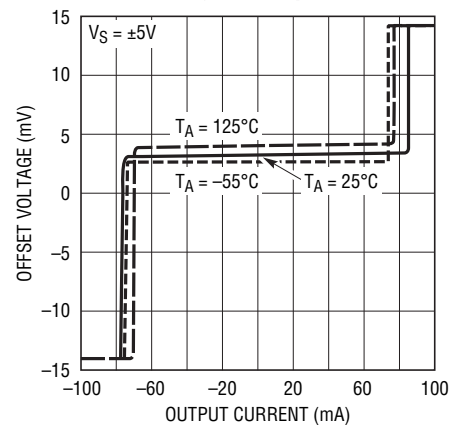

6200 G15

# TYPICAL PERFORMANCE CHARACTERISTICS

**Warm-Up Drift vs Time (LT6200S8)**



6200 G16

**Total Noise vs Source Resistance**



6200 G17

**Input Noise Voltage vs Frequency**

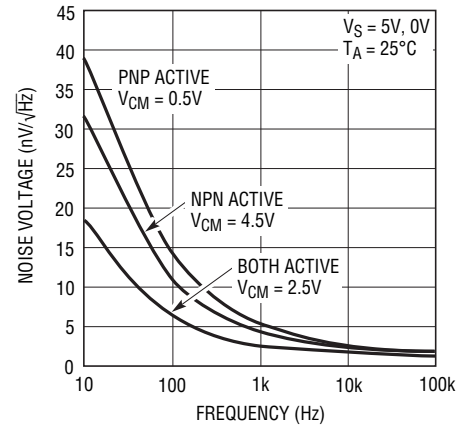

6200 G18

**Balanced Noise Current vs Frequency**



6200 G19

**Unbalanced Noise Current vs Frequency**

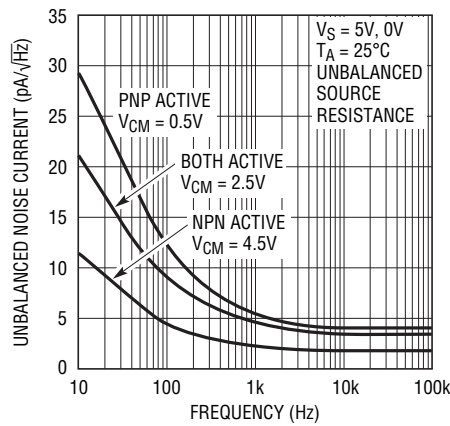

6200 G20

**0.1Hz to 10Hz Output Noise Voltage**

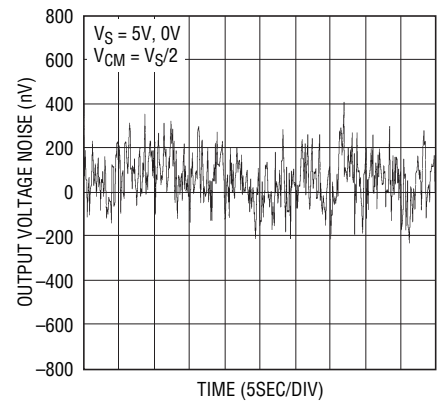

6200 G21

**Supply Current vs SHDN Pin Voltage**



6200 G21a

**SHDN Pin Current vs SHDN Pin Voltage**

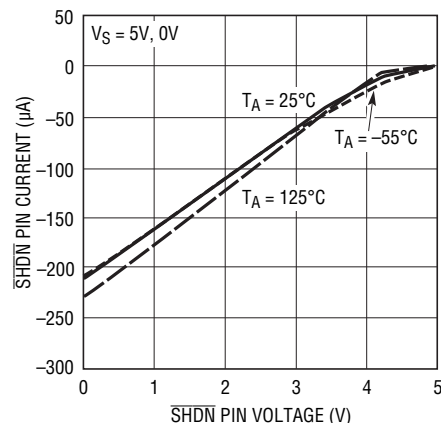

6200 G21b

TYPICAL PERFORMANCE CHARACTERISTICS LT6200, LT6201

Gain Bandwidth and Phase Margin vs Temperature



6200 G22

Open-Loop Gain vs Frequency



6200 G23

Open-Loop Gain vs Frequency

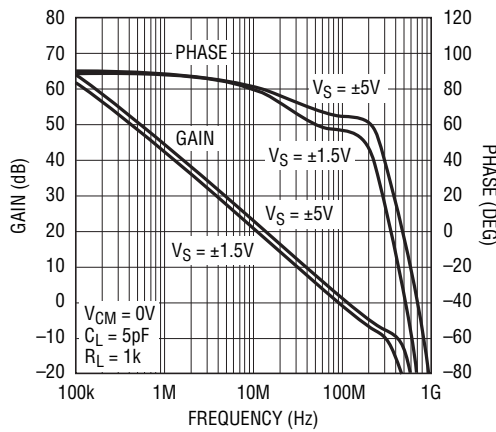

6200 G24

Gain Bandwidth and Phase Margin vs Supply Voltage

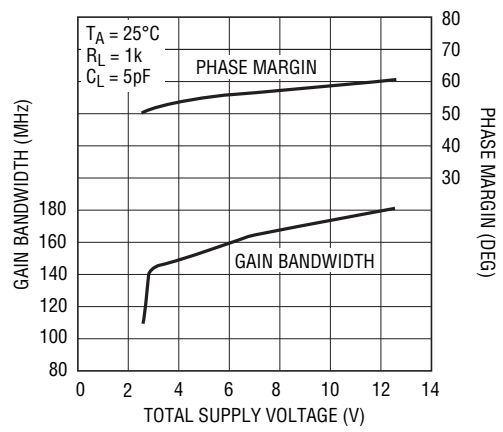

6200 G25

Slew Rate vs Temperature

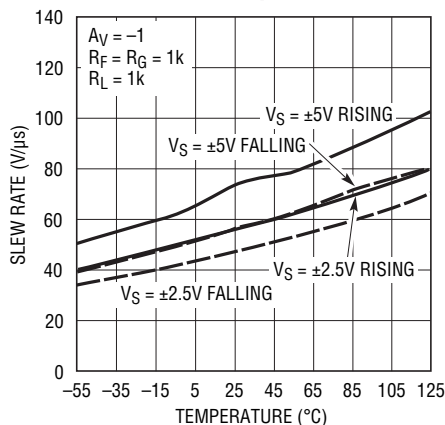

6200 G26

Output Impedance vs Frequency

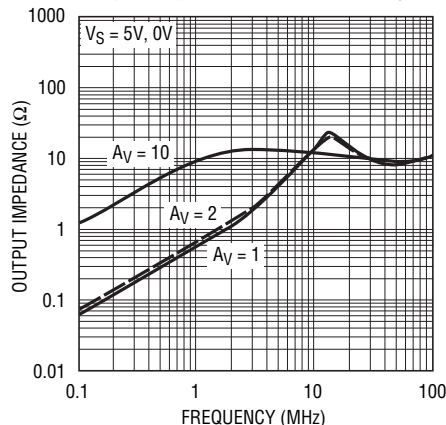

6200 G27

Common Mode Rejection Ratio vs Frequency

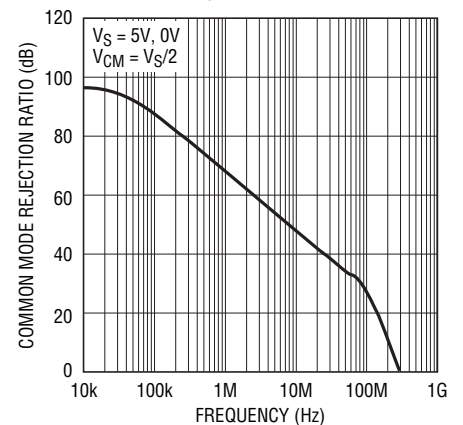

6200 G28

**TYPICAL PERFORMANCE CHARACTERISTICS** LT6200, LT6201

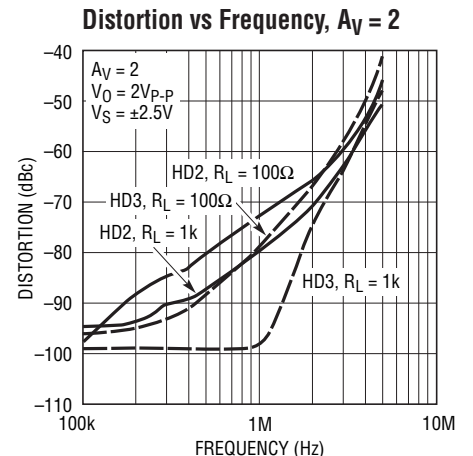
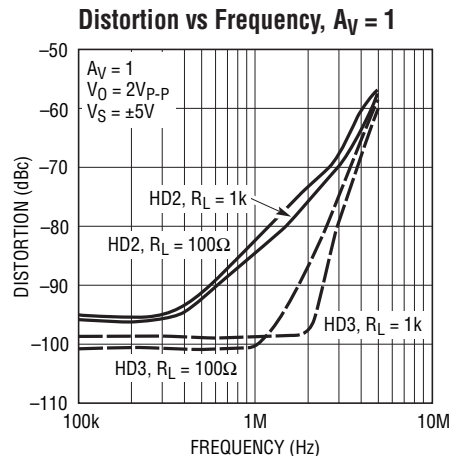
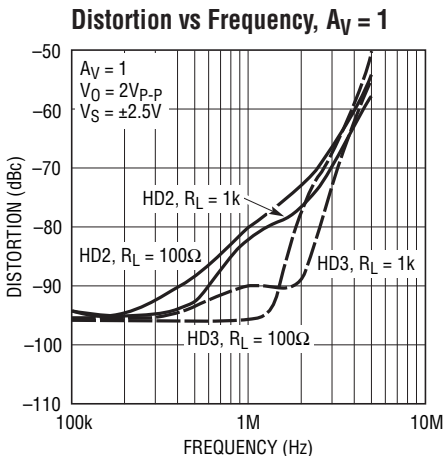
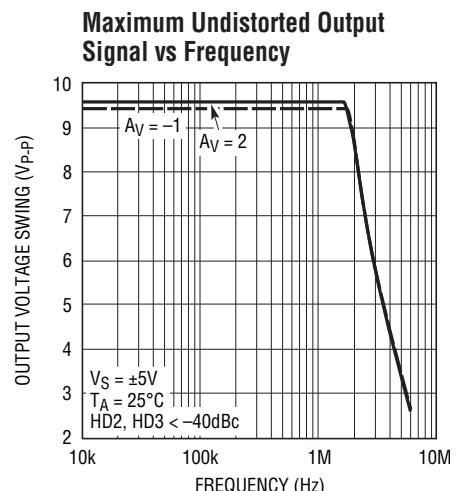
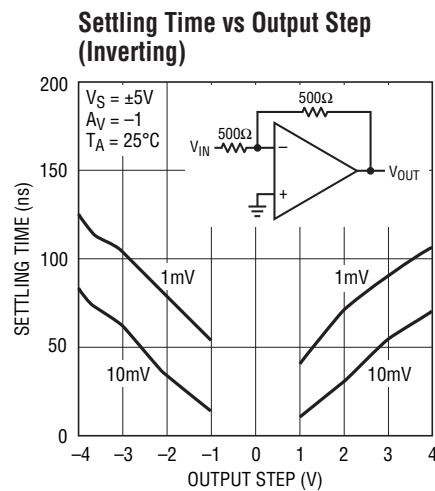
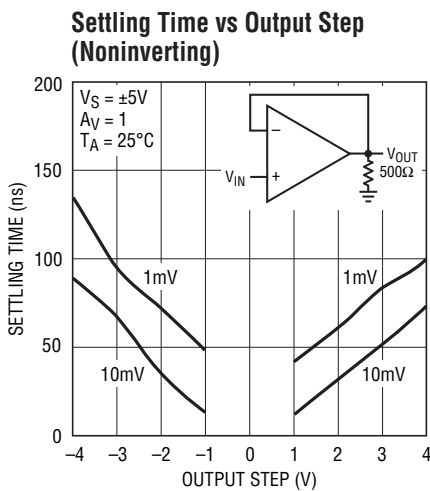
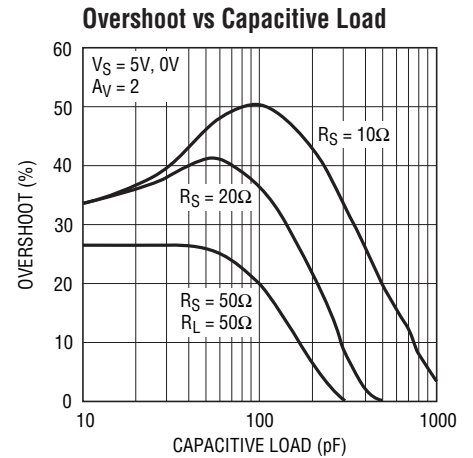
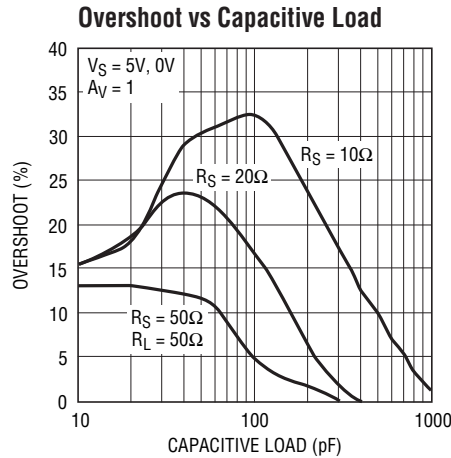
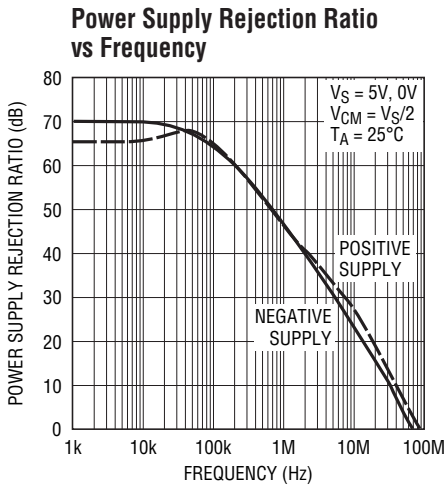

**TYPICAL PERFORMANCE CHARACTERISTICS** LT6200, LT6201

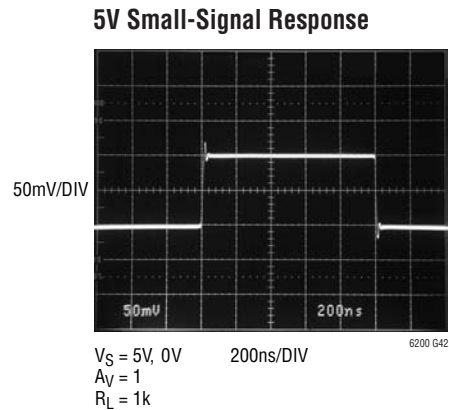
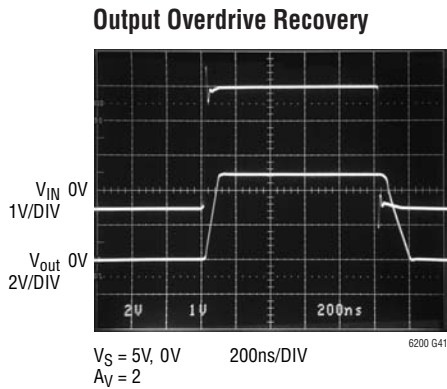
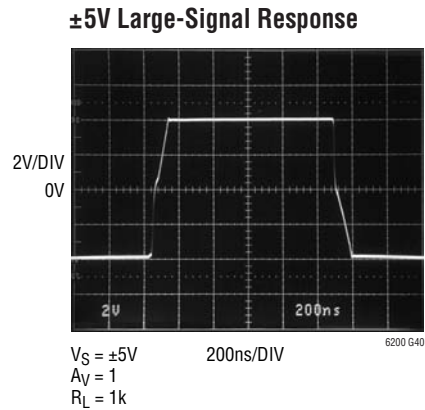
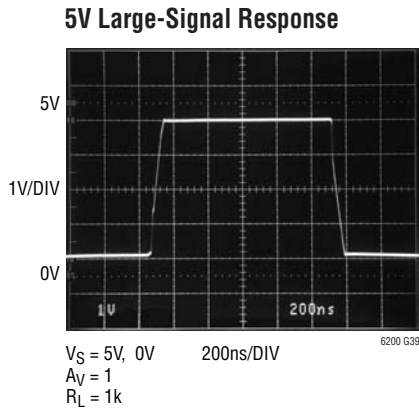
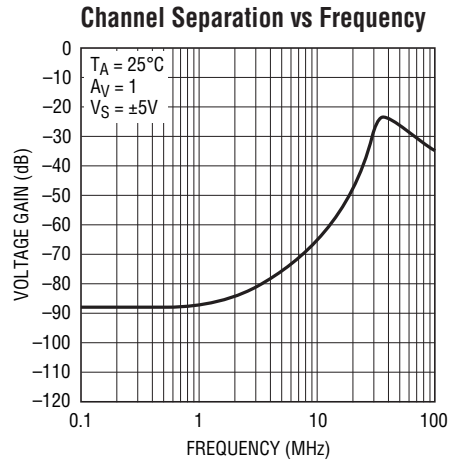
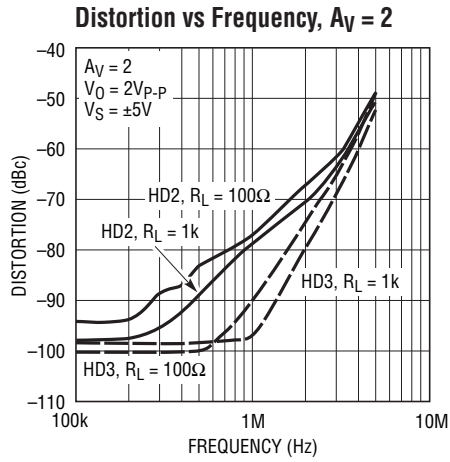

**TYPICAL PERFORMANCE CHARACTERISTICS** LT6200-5

**Gain Bandwidth and Phase Margin vs Temperature**

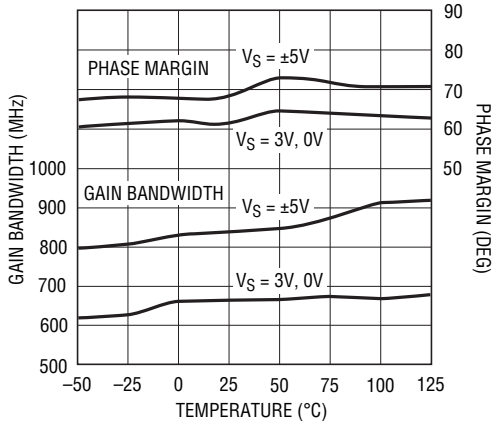

6200 G45

**Slew Rate vs Temperature**

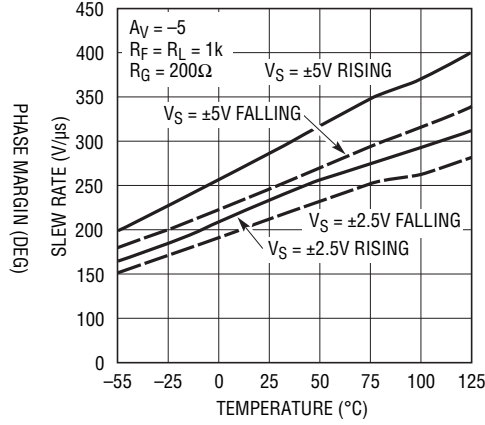

6200 G46

**Overshoot vs Capacitive Load**

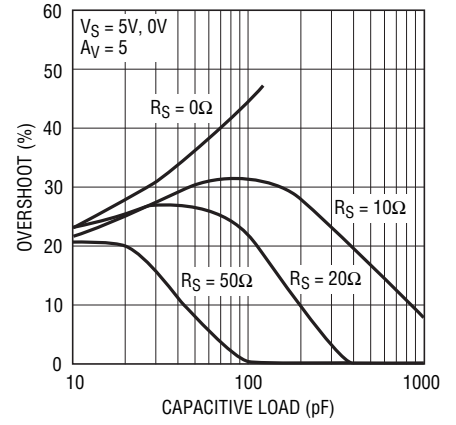

6200 G47

**Power Supply Rejection Ratio vs Frequency**

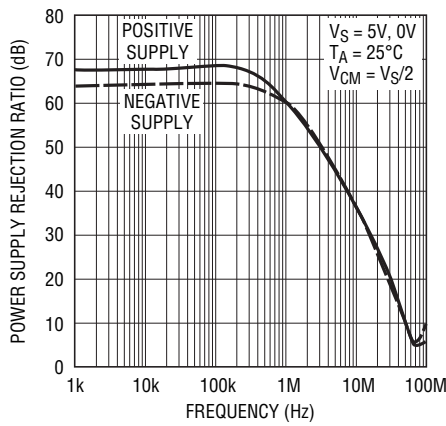

6200 G48

**Output Impedance vs Frequency**

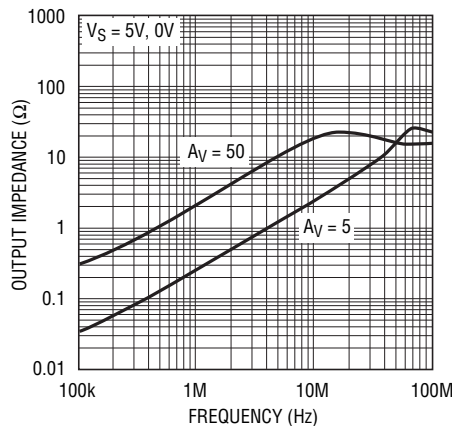

6200 G49

**Open-Loop Gain vs Frequency**

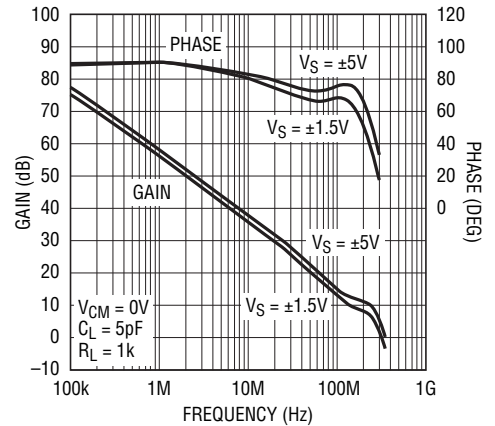

6200 G50

**Open-Loop Gain vs Frequency**

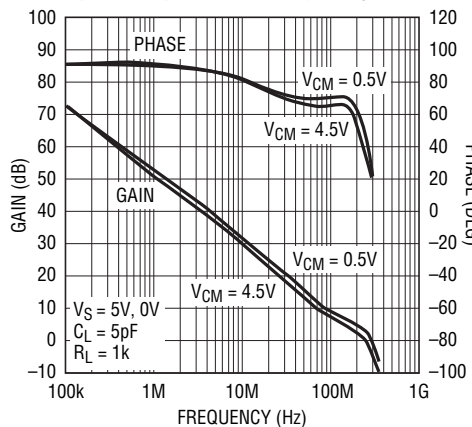

6200 G51

**Gain Bandwidth and Phase Margin vs Supply Voltage**

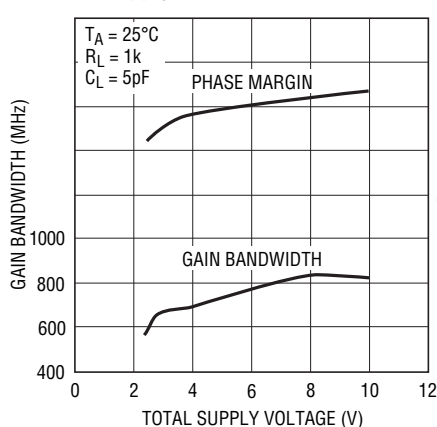

6200 G52

**Gain Bandwidth vs Resistor Load**

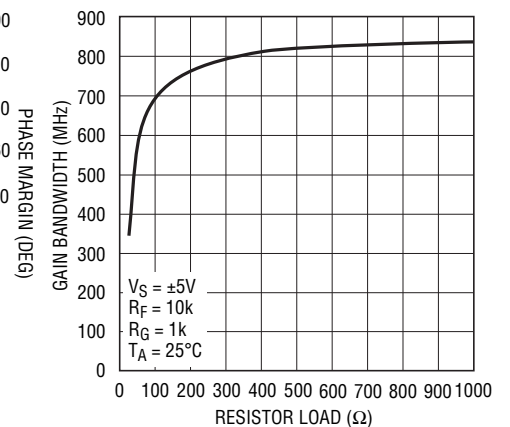

6200 G53

TYPICAL PERFORMANCE CHARACTERISTICS LT6200-5

Common Mode Rejection Ratio vs Frequency

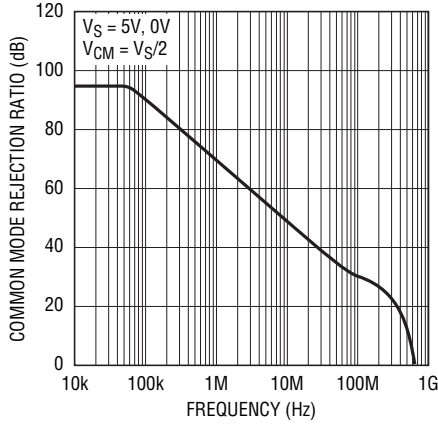

Maximum Undistorted Output Signal vs Frequency

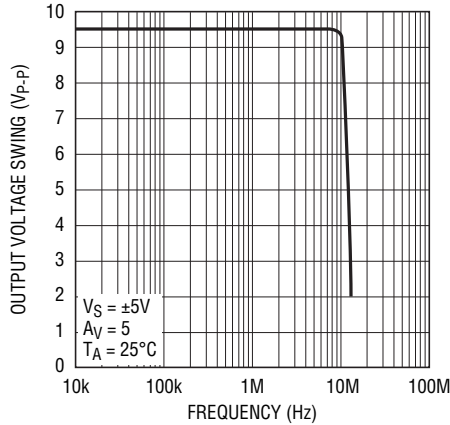

2nd and 3rd Harmonic Distortion vs Frequency

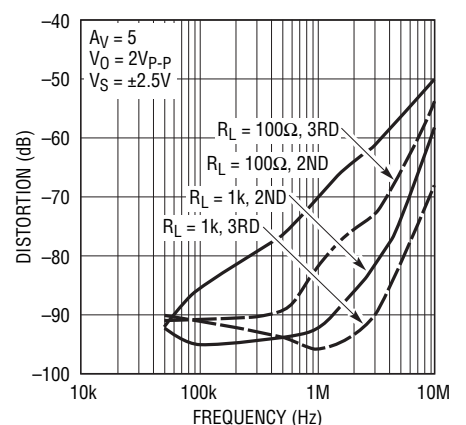

2nd and 3rd Harmonic Distortion vs Frequency

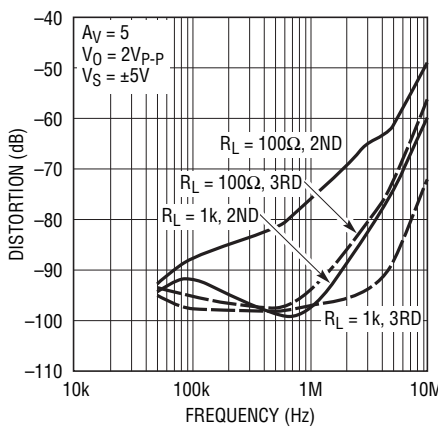

±5V Large-Signal Response

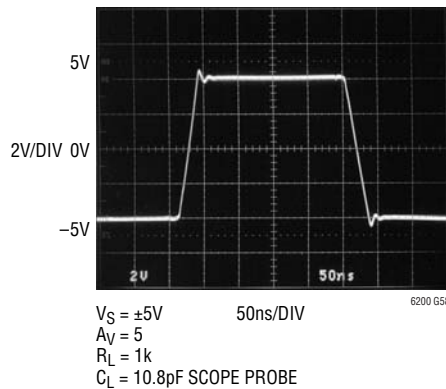

Output-Overdrive Recovery

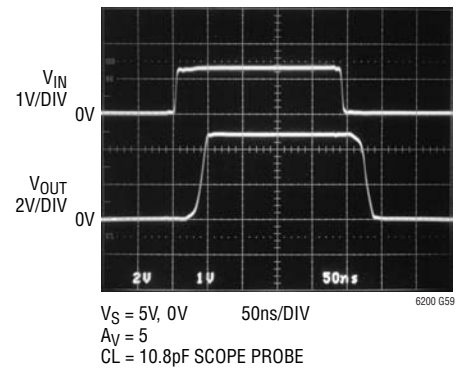

5V Small-Signal Response

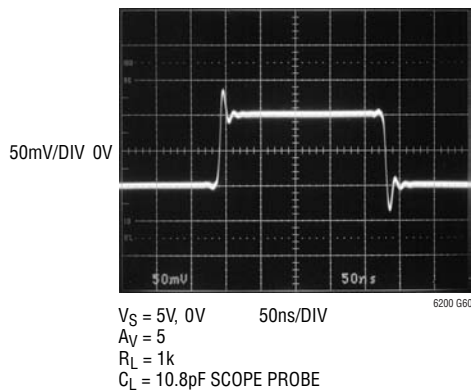

Input Referred High Frequency Noise Spectrum

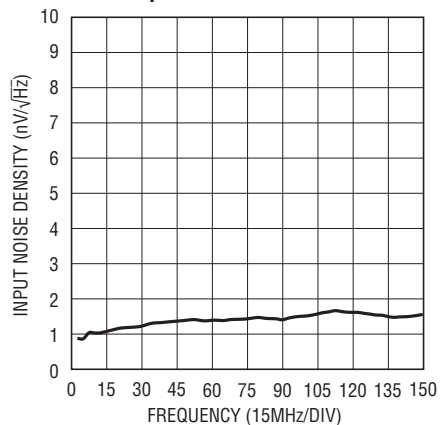

**TYPICAL PERFORMANCE CHARACTERISTICS** LT6200-10

**Gain Bandwidth and Phase Margin vs Temperature**

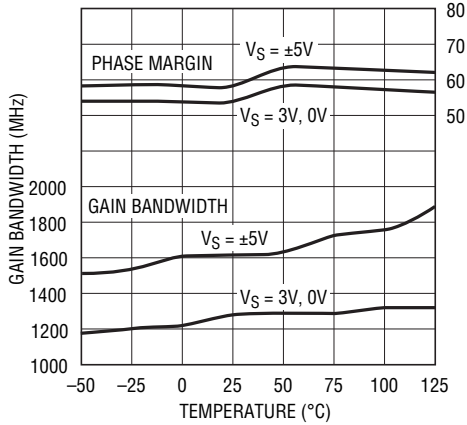

6200 G62

**Slew Rate vs Temperature**

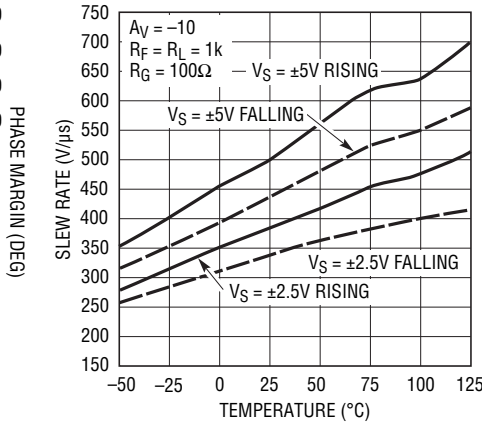

6200 G63

**Overshoot vs Capacitive Load**

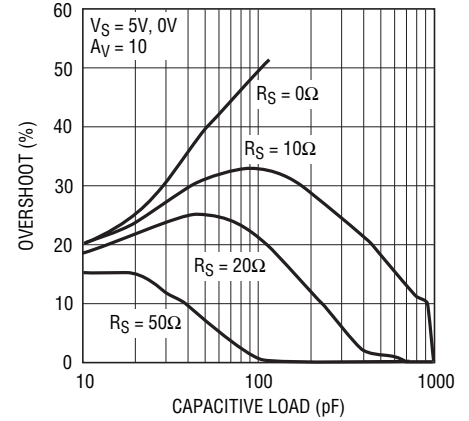

6200 G64

**Power Supply Rejection Ratio vs Frequency**

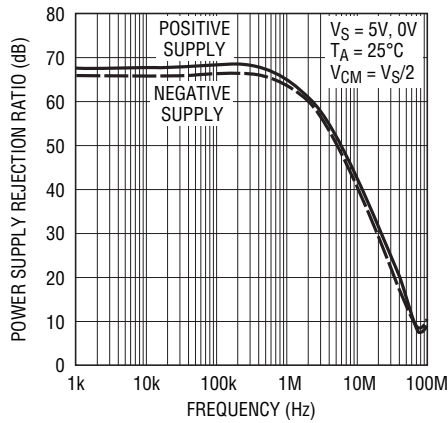

6200 G65

**Output Impedance vs Frequency**

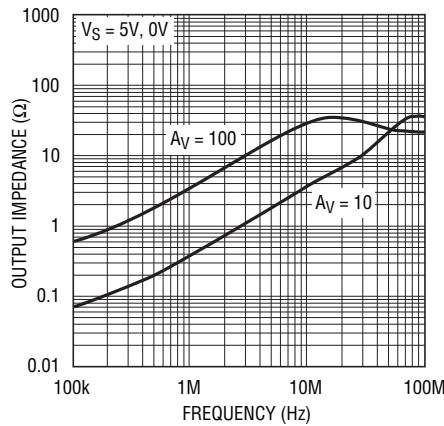

6200 G66

**Open-Loop Gain vs Frequency**

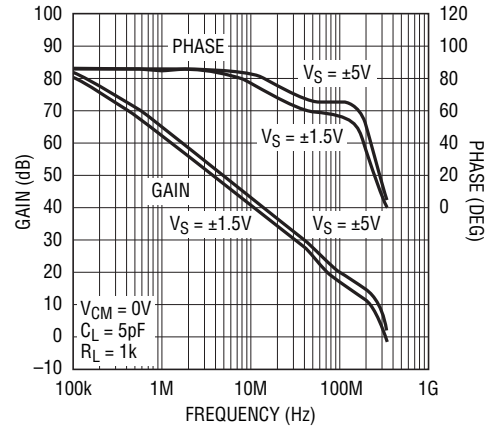

6200 G67

**Open-Loop Gain vs Frequency**

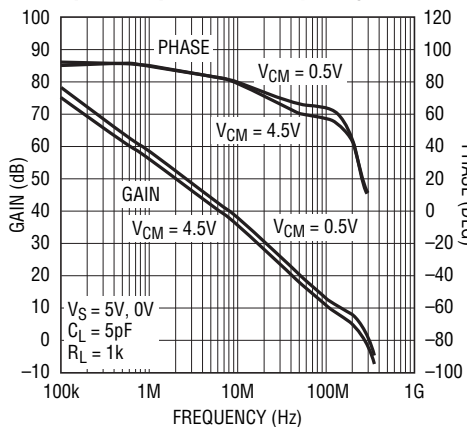

6200 G68

**Gain Bandwidth and Phase Margin vs Supply Voltage**

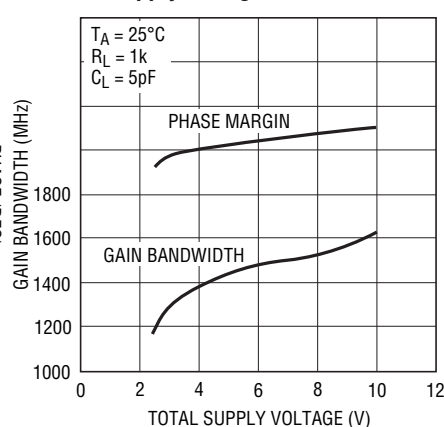

6200 G69

**Gain Bandwidth vs Resistor Load**

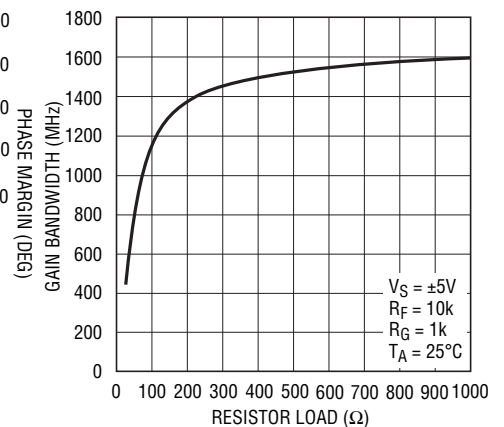

6200 G70

620011f

**TYPICAL PERFORMANCE CHARACTERISTICS** LT6200-10

**Common Mode Rejection Ratio vs Frequency**



6200 G71

**Maximum Undistorted Output Signal vs Frequency**

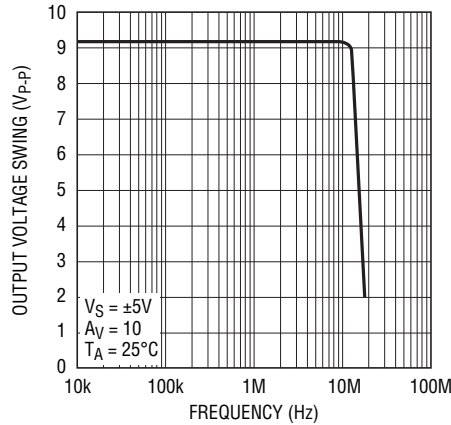

6200 G72

**2nd and 3rd Harmonic Distortion vs Frequency**

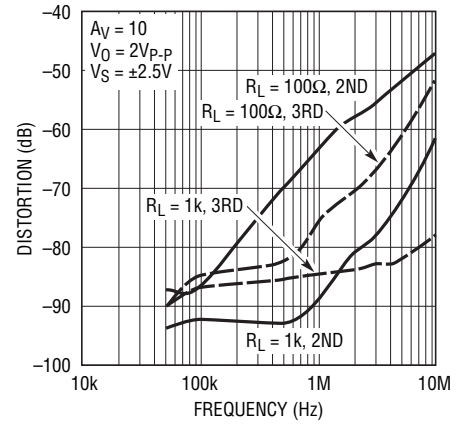

6200 G73

**2nd and 3rd Harmonic Distortion vs Frequency**

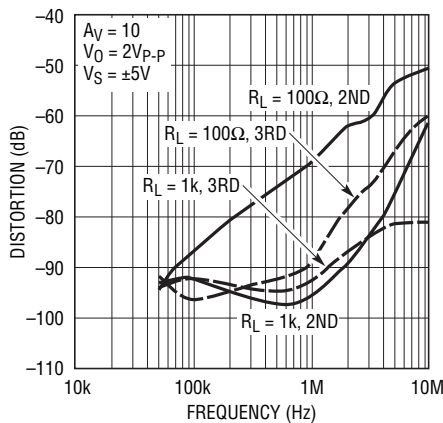

6200 G74

**±5V Large-Signal Response**

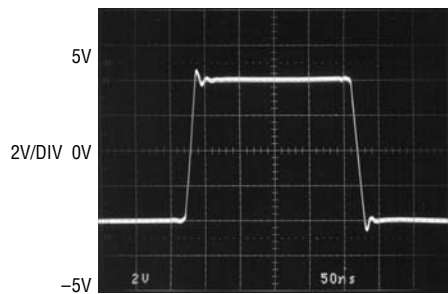

6200 G75

**Output-Overdrive Recovery**

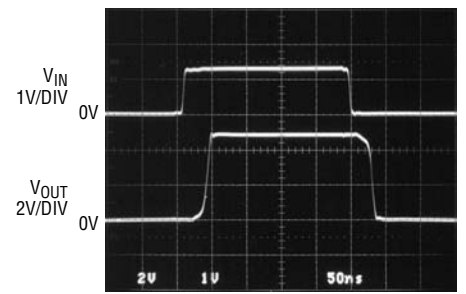

6200 G76

**5V Small-Signal Response**

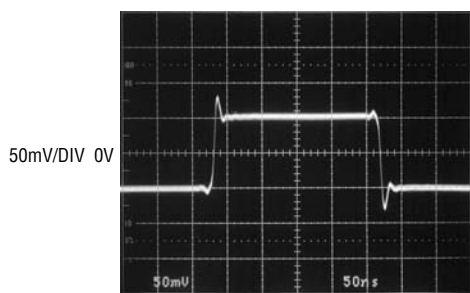

6200 G77

**Input Referred High Frequency Noise Spectrum**

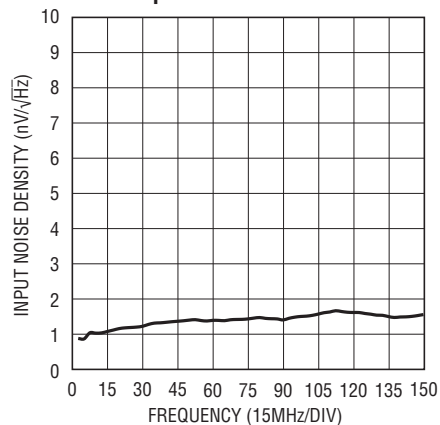

6200 G78

## APPLICATIONS INFORMATION

### Amplifier Characteristics

Figure 1 shows a simplified schematic of the LT6200 family, which has two input differential amplifiers in parallel that are biased on simultaneously when the common mode voltage is at least 1.5V from either rail. This topology allows the input stage to swing from the positive supply voltage to the negative supply voltage. As the common mode voltage swings beyond  $V_{CC} - 1.5V$ , current source  $I_1$  saturates and current in Q1/Q4 is zero. Feedback is maintained through the Q2/Q3 differential amplifier, but with an input  $g_m$  reduction of one-half. A similar effect occurs with  $I_2$  when the common mode voltage swings within 1.5V of the negative rail. The effect of the  $g_m$  reduction is a shift in the  $V_{OS}$  as  $I_1$  or  $I_2$  saturate.

Input bias current normally flows out of the “+” and “-” inputs. The magnitude of this current increases when the input common mode voltage is within 1.5V of the negative rail, and only Q1/Q4 are active. The polarity of this current reverses when the input common mode voltage is within 1.5V of the positive rail and only Q2/Q3 are active.

The second stage is a folded cascode and current mirror that converts the input stage differential signals to a single ended output. Capacitor C1 reduces the unity cross frequency and improves the frequency stability without degrading the gain bandwidth of the amplifier. The differential drive generator supplies current to the output transistors that swing from rail-to-rail.

The LT6200-5/LT6200-10 are decompensated op amps for higher gain applications. These amplifiers maintain identical DC specifications with the LT6200, but have a reduced Miller compensation capacitor  $C_M$ . This results in a significantly higher slew rate and gain bandwidth product.

### Input Protection

There are back-to-back diodes, D1 and D2, across the + and - inputs of these amplifiers to limit the differential input voltage to  $\pm 0.7V$ . The inputs of the LT6200 family do not have internal resistors in series with the input transistors. This technique is often used to protect the input devices from overvoltage that causes excessive currents to flow. The addition of these resistors would significantly degrade the low noise voltage of these amplifiers. For instance, a  $100\Omega$  resistor in series with each input would generate  $1.8nV/\sqrt{Hz}$  of noise, and the total amplifier noise voltage would rise from  $0.95nV/\sqrt{Hz}$  to  $2.03nV/\sqrt{Hz}$ . Once the input differential voltage exceeds  $\pm 0.7V$ , steady-state current conducted through the protection diodes should be limited to  $\pm 40mA$ . This implies  $25\Omega$  of protection resistance per volt of continuous overdrive beyond  $\pm 0.7V$ . The input diodes are rugged enough to handle transient currents due to amplifier slew rate overdrive or momentary clipping without these resistors.

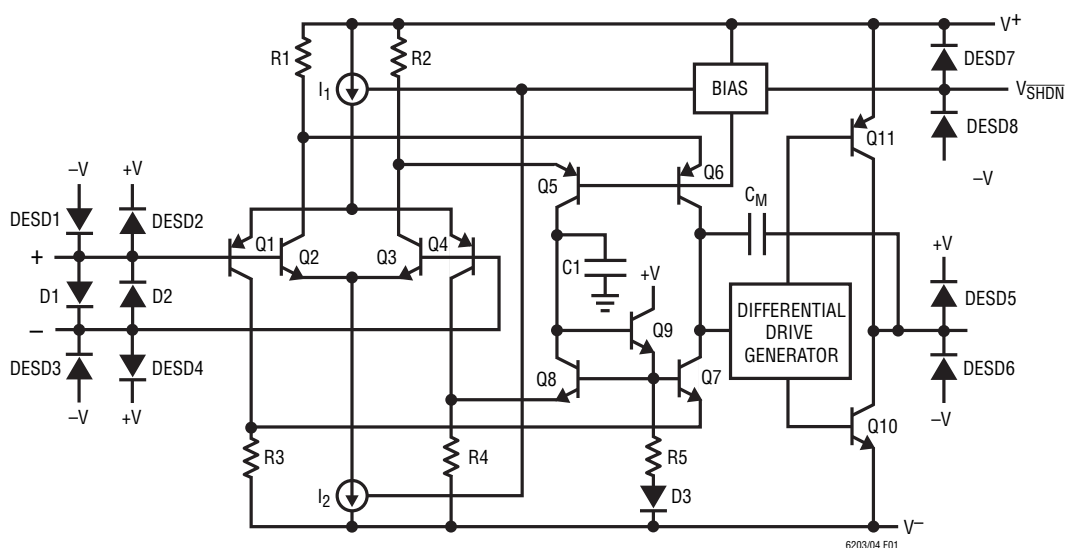

Figure 1. Simplified Schematic

620304 F01

## APPLICATIONS INFORMATION

Figure 2 shows the input and output waveforms of the LT6200 driven into clipping while connected in a gain of  $A_V = 1$ . In this photo, the input signal generator is clipping at  $\pm 35\text{mA}$ , and the output transistors supply this generator current through the protection diodes.



Figure 2.  $V_S = \pm 2.5\text{V}$ ,  $A_V = 1$  with Large Overdrive

### ESD

The LT6200 has reverse-biased ESD protection diodes on all inputs and outputs, as shown in Figure 1. If these pins are forced beyond either supply, unlimited current will flow through these diodes. If the current is transient and limited to 30mA or less, no damage to the device will occur.

### Noise

The noise voltage of the LT6200 is equivalent to that of a  $56\Omega$  resistor—and for the lowest possible noise, it is desirable to keep the source and feedback resistance at or below this value (i.e.,  $R_S + R_G//R_{FB} \leq 56\Omega$ ). With  $R_S + R_G//R_{FB} = 56\Omega$  the total noise of the amplifier is:  $e_n = \sqrt{(0.95\text{nV})^2 + (0.95\text{nV})^2} = 1.35\text{nV}$ . Below this resistance value the amplifier dominates the noise, but in the resistance region between  $56\Omega$  and approximately  $6\text{k}\Omega$ , the noise is dominated by the resistor thermal noise. As the total resistance is further increased, beyond  $6\text{k}\Omega$ , the noise current multiplied by the total resistance eventually dominates the noise.

For a complete discussion of amplifier noise, see the LT1028 data sheet.

### Power Dissipation

The LT6200 combines high speed with large output current in a small package, so there is a need to ensure that the die's junction temperature does not exceed  $150^\circ\text{C}$ . The LT6200 is housed in a 6-lead TSOT-23 package. The package has the  $V^-$  supply pin fused to the lead frame to enhance the thermal conductance when connecting to a ground plane or a large metal trace. Metal trace and plated through-holes can be used to spread the heat generated by the device to the backside of the PC board. For example, on a  $3/32$ " FR-4 board with 2oz copper, a total of  $270\text{mm}^2$  connects to Pin 2 of the LT6200 (in a TSOT-23 package) bringing the thermal resistance,  $\theta_{JA}$ , to about  $135^\circ\text{C}/\text{W}$ . Without an extra metal trace beside the power line connecting to the  $V^-$  pin to provide a heat sink, the thermal resistance will be around  $200^\circ\text{C}/\text{W}$ . More information on thermal resistance with various metal areas connecting to the  $V^-$  pin is provided in Table 1.

Table 1. LT6200 6-Lead TSOT-23 Package

| COPPER AREA<br>TOPSIDE ( $\text{mm}^2$ ) | BOARD AREA<br>( $\text{mm}^2$ ) | THERMAL RESISTANCE<br>(JUNCTION-TO-AMBIENT) |
|--|---------------------------------|---|
| 270                                      | 2500                            | $135^\circ\text{C}/\text{W}$                |
| 100                                      | 2500                            | $145^\circ\text{C}/\text{W}$                |
| 20                                       | 2500                            | $160^\circ\text{C}/\text{W}$                |
| 0  | 2500                            | $200^\circ\text{C}/\text{W}$                |

Device is mounted on topside.

Junction temperature  $T_J$  is calculated from the ambient temperature  $T_A$  and power dissipation  $P_D$  as follows:

$$T_J = T_A + (P_D \cdot \theta_{JA})$$

The power dissipation in the IC is the function of the supply voltage, output voltage and the load resistance. For a given supply voltage, the worst-case power dissipation  $P_{D(\text{MAX})}$  occurs at the maximum quiescent supply current and at the output voltage which is half of either supply voltage (or the maximum swing if it is less than half the supply voltage).  $P_{D(\text{MAX})}$  is given by:

$$P_{D(\text{MAX})} = (V_S \cdot I_{S(\text{MAX})}) + (V_S/2)^2/R_L$$

Example: An LT6200 in TSOT-23 mounted on a  $2500\text{mm}^2$  area of PC board without any extra heat spreading plane connected to its  $V^-$  pin has a thermal resistance of

## APPLICATIONS INFORMATION

200°C/W,  $\theta_{JA}$ . Operating on  $\pm 5V$  supplies driving 50 $\Omega$  loads, the worst-case power dissipation is given by:

$$P_{D(MAX)} = (10 \cdot 23mA) + (2.5)^2/50 \\ = 0.23 + 0.125 = 0.355W$$

The maximum ambient temperature that the part is allowed to operate is:

$$T_A = T_J - (P_{D(MAX)} \cdot 200^\circ C/W) \\ = 150^\circ C - (0.355W \cdot 200^\circ C/W) = 79^\circ C$$

To operate the device at a higher ambient temperature, connect more metal area to the  $V^-$  pin to reduce the thermal resistance of the package, as indicated in Table 1.

### DD Package Heat Sinking

The underside of the DD package has exposed metal (4mm<sup>2</sup>) from the lead frame where the die is attached. This provides for the direct transfer of heat from the die junction to printed circuit board metal to help control the maximum operating junction temperature. The dual-in-line pin arrangement allows for extended metal beyond the ends of the package on the topside (component side) of

a PCB. Table 2 summarizes the thermal resistance from the die junction-to-ambient that can be obtained using various amounts of topside metal (2oz copper) area. On multilayer boards, further reductions can be obtained using additional metal on inner PCB layers connected through vias beneath the package.

Table 2. LT6200 8-Lead DD Package

| COPPER AREA<br>TOPSIDE (mm <sup>2</sup> ) | THERMAL RESISTANCE<br>(JUNCTION-TO-AMBIENT) |
|---|---|
| 4   | 160°C/W                                     |
| 16  | 135°C/W                                     |
| 32  | 110°C/W                                     |
| 64  | 95°C/W                                      |
| 130                                       | 70°C/W                                      |

The LT6200 amplifier family has thermal shutdown to protect the part from excessive junction temperature. The amplifier will shut down to approximately 1.2mA supply current per amplifier if 160°C is exceeded. The LT6200 will remain off until the junction temperature reduces to about 150°C, at which point the amplifier will return to normal operation.



## PACKAGE DESCRIPTION

Please refer to <http://www.linear.com/designtools/packaging/> for the most recent package drawings.

**S8 Package**  
**8-Lead Plastic Small Outline (Narrow .150 Inch)**  
 (Reference LTC DWG # 05-08-1610)



- NOTE:  
 1. DIMENSIONS IN  $\frac{\text{INCHES}}{\text{MILLIMETERS}}$   
 2. DRAWING NOT TO SCALE  
 3. THESE DIMENSIONS DO NOT INCLUDE MOLD FLASH OR PROTRUSIONS.  
 MOLD FLASH OR PROTRUSIONS SHALL NOT EXCEED .006" (0.15mm)

S08 0303

**REVISION HISTORY** (Revision history begins at Rev D)

| REV | DATE  | DESCRIPTION  | PAGE NUMBER   |
|-----|-------|--|---------------|
| D   | 3/10  | Change to Input Noise Voltage Density in the Electrical Characteristics section.<br>Change to X-Axis Range on Graph G61.   | 7<br>17       |
| E   | 9/11  | Updated typical value for $t_{ON}$ in the Electrical Characteristics section.<br>Replaced curves G61 and G78 in the Typical Performance Characteristics section. | 4-9<br>17, 19 |
| F   | 12/11 | Revised formatting of Slew Rate and Gain Bandwidth in Electrical Characteristics tables.   | 4-10          |

## TYPICAL APPLICATION

Rail-to-Rail, High Speed, Low Noise Instrumentation Amplifier

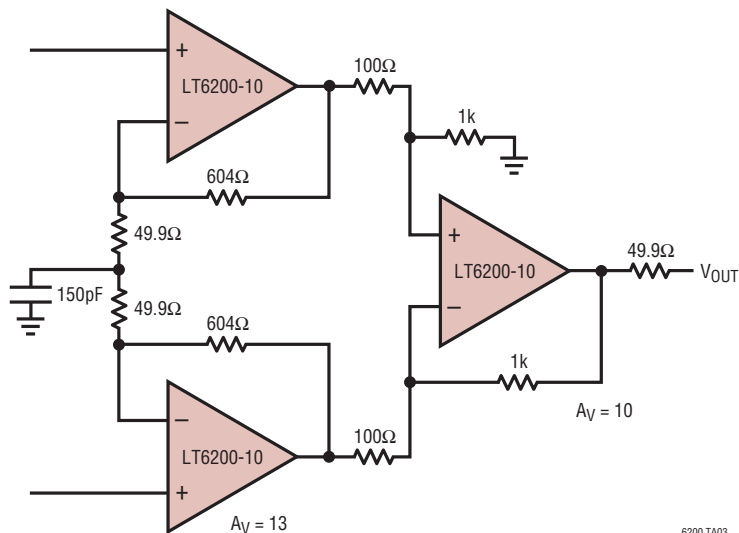

6200 TA03

Instrumentation Amplifier Frequency Response

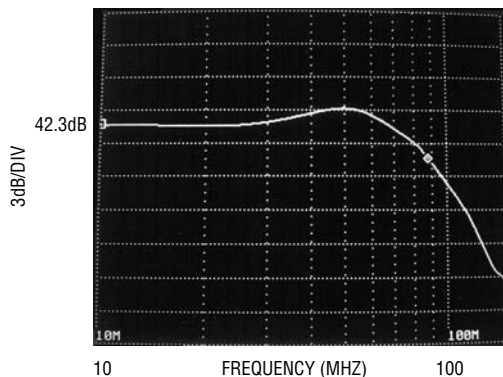

$A_V = 130$   
 $BW_{-3dB} = 85\text{MHz}$   
 SLEW RATE = 500V/ $\mu\text{s}$   
 CMRR = 55dB at 10MHz

6200 TA04

## RELATED PARTS

| PART NUMBER          | DESCRIPTION  | COMMENTS   |
|----------------------|--|--|
| LT1028               | Single, Ultralow Noise 50MHz Op Amp                  | 1.1nV/ $\sqrt{\text{Hz}}$  |
| LT1677               | Single, Low Noise Rail-to-Rail Amplifier             | 3V Operation, 2.5mA, 4.5nV/ $\sqrt{\text{Hz}}$ , 60 $\mu\text{V}$ Max $V_{OS}$                   |
| LT1722/LT1723/LT1724 | Single/Dual/Quad Low Noise Precision Op Amp          | 70V/ $\mu\text{s}$ Slew Rate, 400 $\mu\text{V}$ Max $V_{OS}$ , 3.8nV/ $\sqrt{\text{Hz}}$ , 3.7mA |
| LT1806/LT1807        | Single/Dual, Low Noise 325MHz Rail-to-Rail Amplifier | 2.5V Operation, 550 $\mu\text{V}$ Max $V_{OS}$ , 3.5nV/ $\sqrt{\text{Hz}}$                       |
| LT6203               | Dual, Low Noise, Low Current Rail-to-Rail Amplifier  | 1.9nV/ $\sqrt{\text{Hz}}$ , 3mA Max, 100MHz Gain Bandwidth                                       |

## Looking for pricing, stock, or lifecycle information?

Click below to explore more details on WIN SOURCE:

 [View LT6200CS6#TRPBF on WIN SOURCE](#)

 [Linear Technology](#) Information

## Optimize Your Supply Chain with WIN SOURCE Solutions

-  Global Sourcing Solution
-  Obsolete Management
-  Cost Control Management
-  Shortage Management
-  Alternative Solution
-  Excess Inventory Management