



**THE DATASHEET OF
EHF-110-01-LM-D-SM-LC-A**



DO NOT SCALE FROM THIS PRINT

FIG 1
EHF-110-01-XX-D-SM-LC

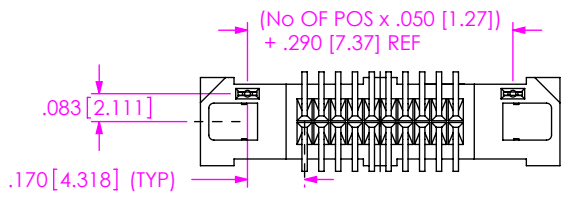
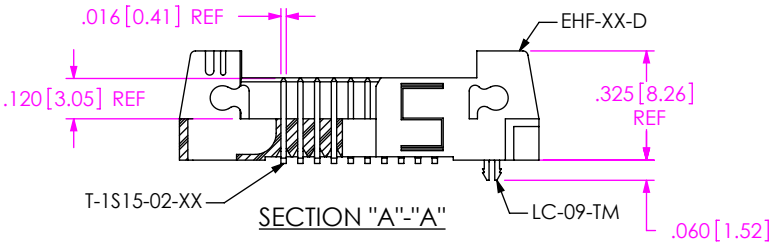
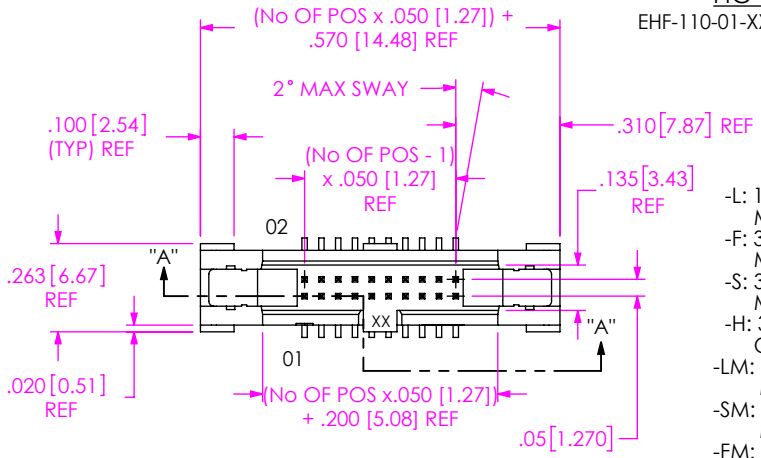

EHF-1XX-01-XX-D-XX-XX-XX

NO OF POSITIONS
-03, -04, -05, -08, -10, -13, -17, -20, -25

LEAD STYLE
-01

PLATING SPECIFICATION

- L: 10μ" SELECTIVE GOLD IN CONTACT AREA, MATTE TIN ON TAIL (USE T-1SXX-XX-L)
- F: 3μ" SELECTIVE GOLD IN CONTACT AREA, MATTE TIN ON TAIL (USE T-1SXX-XX-F)
- S: 30μ" SELECTIVE GOLD IN CONTACT AREA, MATTE TIN ON TAIL (USE T-1SXX-XX-S)
- H: 30μ" GOLD IN CONTACT AREA, 3μ" GOLD ON TAIL (USE T-1SXX-XX-H)
- LM: 10μ" SELECTIVE GOLD IN CONTACT AREA, MATTE TIN ON TAIL (USE T-1SXX-XX-L)
- SM: 30μ" SELECTIVE GOLD IN CONTACT AREA, MATTE TIN ON TAIL (USE T-1SXX-XX-S)
- FM: 3μ" SELECTIVE GOLD IN CONTACT AREA, MATTE TIN ON TAIL (USE T-1SXX-XX-F)

OPTION

- LC: LOCKING CLIP (FOR -D-SM ONLY) (SEE NOTE 7)
- P: PICK & PLACE PAD (FOR -D-SM ONLY) (FOR -03 & -04, USE PPP-25, SEE FIG 7, SHT 3) (FOR -05 THRU -25, USE PPP-48, SEE FIG 2)
- K: POLYIMIDE FILM (USE K-500-300, SEE FIG 3)
- TR: TAPE & REEL PACKAGING (FOR -D-SM, -D-SM-P, & -D-SM-K ONLY) (NOT AVAILABLE ON -D-SM-LC)

POLARIZED OPTION
-XX = PIN OMITTED (N/A ON -RA OPTION)

TAIL OPTION
(LEAVE BLANK FOR THROUGH HOLE, SEE FIG 4, SHEET 2; USE T-1S63-01-XX)
-SM: SURFACE MOUNT (USE T-1S15-02-XX)
-RA: RIGHT ANGLE (USE T-1S63-02-XX AND T-1S63-03-XX) (SEE FIG 5, SHEET 2)

ROW SPECIFICATION
-D: DOUBLE

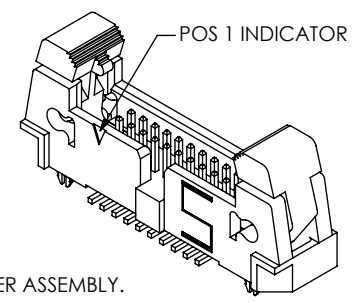
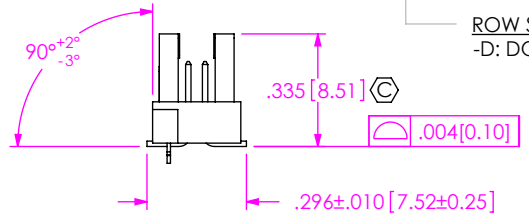

NOTES:

1. Ⓢ REPRESENTS A CRITICAL DIMENSION.
2. COPLANARITY TO BE WITHIN .004[0.10].
3. MAXIMUM BURR ALLOWANCE: .0015 [0.038].
4. MINIMUM PUSHOUT FORCE: 1 LB.
5. MAXIMUM ALLOWABLE BOW: .002[0.05] INCH/INCH AFTER ASSEMBLY.
6. NOTE DELETED.
7. DUE TO THE HIGH AMOUNT OF INSERTION FORCE NEEDED, THE -LC OPTION IS NOT COMPATIBLE WITH AUTO PLACEMENT. SAMTEC RECOMMENDS MANUAL PLACEMENT FOR ALL ASSEMBLIES WITH THE -LC OPTION.

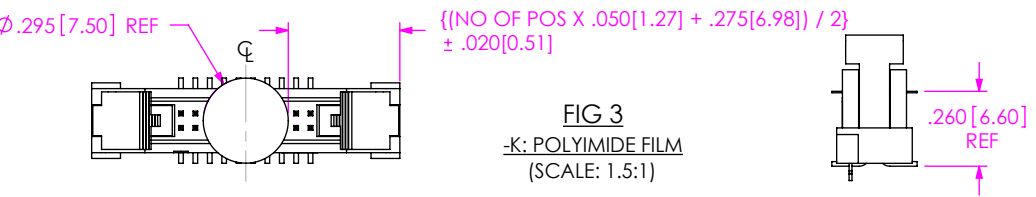
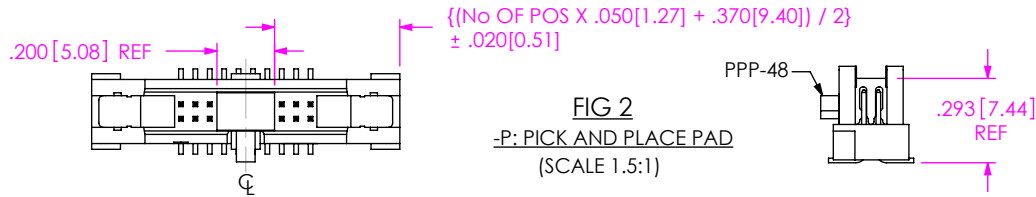
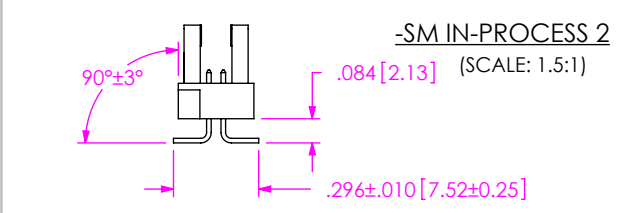
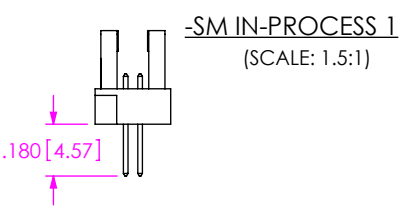

ARM ASSEMBLY & ROTATION

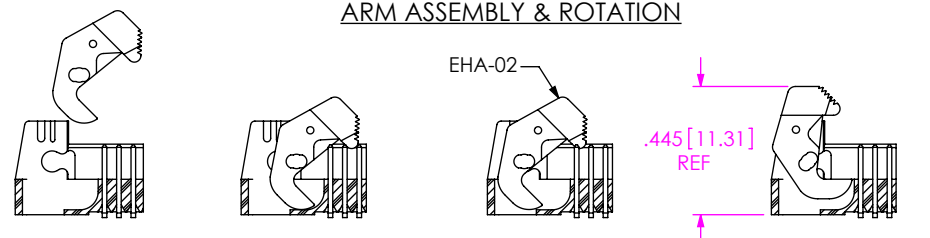

UNLESS OTHERWISE SPECIFIED, DIMENSIONS ARE IN INCHES.

TOLERANCES ARE:
DECIMALS ANGLES
.XX: ±.01[0.3]
.XXX: ±.005[0.13]
.XXXX: ±.0020[0.051]

PROPRIETARY NOTE
THIS DOCUMENT CONTAINS CONFIDENTIAL AND PROPRIETARY INFORMATION AND ALL DESIGN, MANUFACTURING, REPRODUCTION, USE, PATENT RIGHTS AND SALES RIGHTS ARE EXPRESSLY RESERVED BY SAMTEC, INC. THIS DOCUMENT SHALL NOT BE DISCLOSED, IN WHOLE OR PART, TO ANY UNAUTHORIZED PERSON OR ENTITY NOR REPRODUCED, TRANSFERRED OR INCORPORATED IN ANY OTHER PROJECT IN ANY MANNER WITHOUT THE EXPRESS WRITTEN CONSENT OF SAMTEC, INC.



520 PARK EAST BLVD, NEW ALBANY, IN 47150
PHONE: 812-944-6733 FAX: 812-948-5047
e-Mail: info@SAMTEC.com code: 53322

MATERIAL: DO NOT SCALE DRAWING
INSULATOR: VECTRA E130i, COLOR BLACK 50% REGRIND
TERMINAL: PHOS BRONZE 510 SPRING

SHEET SCALE: 1.75:1

DESCRIPTION:
.050 EJECTOR HEADER ASSEMBLY

DWG. NO.
EHF-1XX-01-XX-D-XX-XX-XX

BY: ERIC M. 08/17/01 SHEET 1 OF 3

FIG 4

STANDARD THROUGH HOLE
(SHOWN: EHF-110-01-XX-D)
(SAME AS FIG 1, UNLESS OTHERWISE STATED)

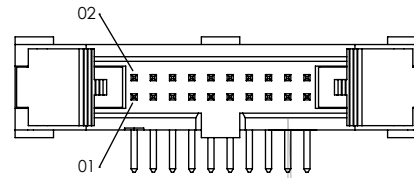
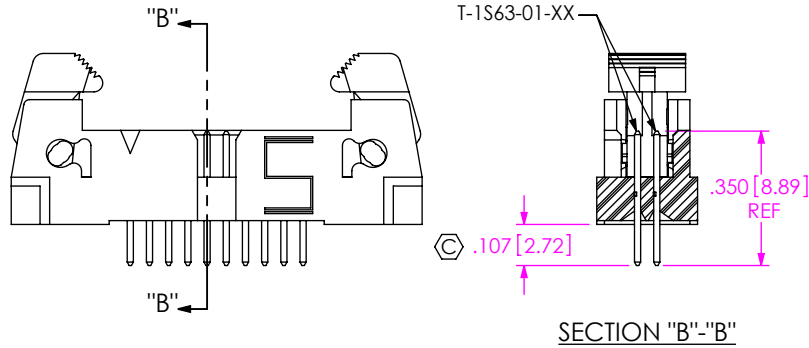
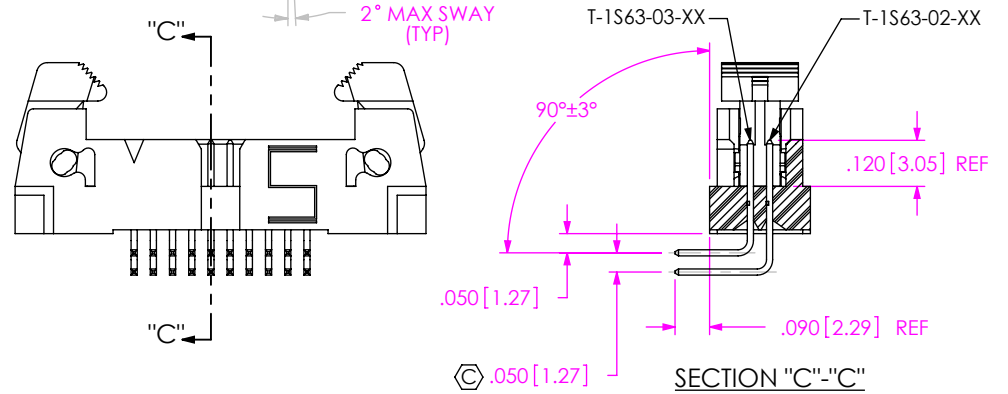

FIG 5

-RA: RIGHT ANGLE OPTION
(SHOWN: EHF-110-01-XX-D-RA)
(SAME AS FIG 1, UNLESS OTHERWISE STATED)



PACKAGING VIEWS

(LOAD PARTS WITH POSITION #1 INDICATOR
IN SAME DIRECTION AS ARROW ON TUBE)

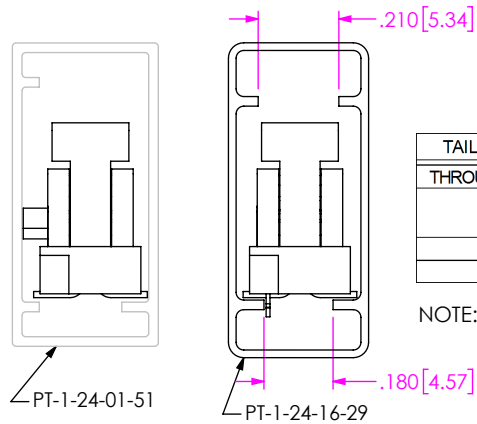

TAIL OPTION	OPTION	PACKAGING TUBE	PLUG
THROUGH HOLE	N/A	PT-1-24-05-09	TP-07
-SM	NONE, -LC, -K, -LC-K	PT-1-24-16-29	
-SM	-P, -LC-P	PT-1-24-01-51	TP-13
-RA	N/A	PT-1-24-01-52	

NOTE: ARROW POINTS INTO THE SHEET AWAY FROM YOU.

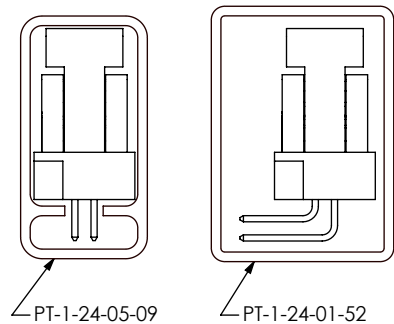

EJECTOR ARM MUST BE IN UPRIGHT POSITION WHEN LOADED INTO TUBES

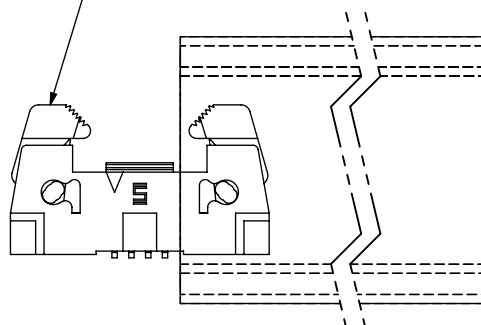

-RA IN-PROCESS 1

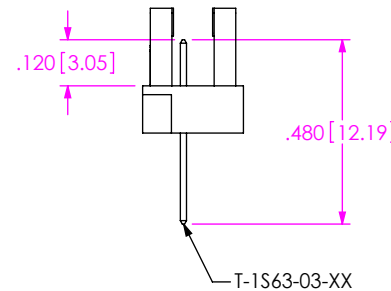

-RA IN-PROCESS 2

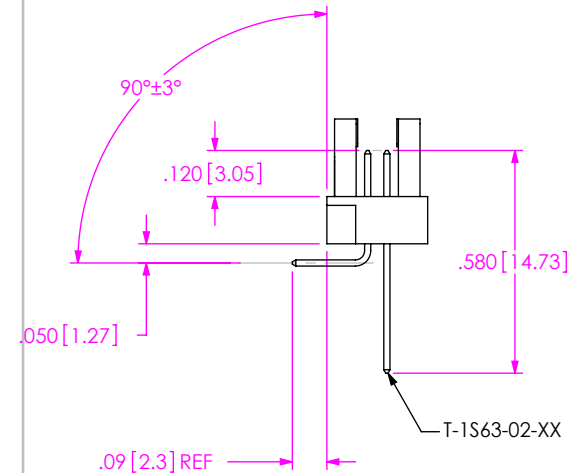

F:\dwg\sw\exisprod\assembly\050\EHF-1XX-01-XX-D-XX-XX-XX-ASM.SLDDRW

PROPRIETARY NOTE
THIS DOCUMENT CONTAINS CONFIDENTIAL AND PROPRIETARY INFORMATION AND ALL DESIGN, MANUFACTURING, REPRODUCTION, USE, PATENT RIGHTS AND SALES RIGHTS ARE EXPRESSLY RESERVED BY SAMTEC, INC. THIS DOCUMENT SHALL NOT BE DISCLOSED, IN WHOLE OR IN PART, TO ANY UNAUTHORIZED PERSON OR ENTITY NOR REPRODUCED, TRANSFERRED OR INCORPORATED IN ANY OTHER PROJECT IN ANY MANNER WITHOUT THE EXPRESS WRITTEN CONSENT OF SAMTEC, INC.

DO NOT SCALE DRAWING

SHEET SCALE: 2:1



520 PARK EAST BLVD, NEW ALBANY, IN 47150
PHONE: 812-944-6733 FAX: 812-948-5047
e-Mail: info@SAMTEC.com code: 55322

DESCRIPTION: .050 EJECTOR HEADER ASSEMBLY
DWG. NO. EHF-1XX-01-XX-D-XX-XX-XX
BY: ERIC M. 08/17/01 SHEET 2 OF 3

FIG 6
 -SM: SURFACE MOUNT OPTION
 (SHOWN: EHF-110-01-XX-D-SM-LC)
 (SHOWN WITH LATCHES OPEN)

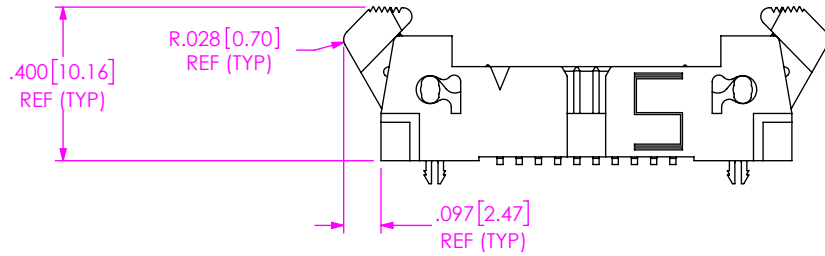
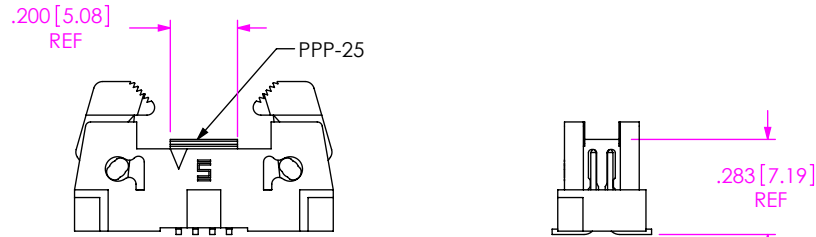

FIG 7
 -03 & -04 PICK AND PLACE PAD
 (SHOWN: EHF-104-01-XX-D-SM-XX-P)



LATCHES OMITTED FOR CLARITY

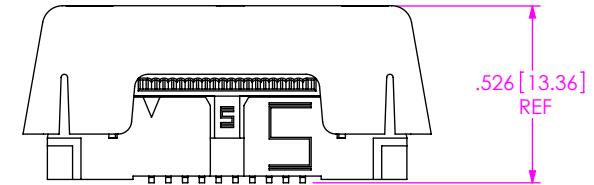
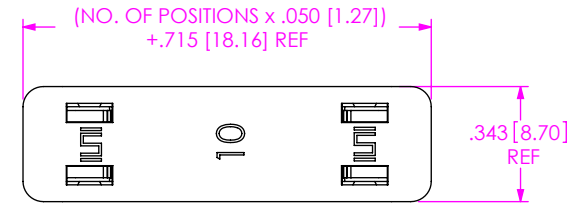

FIG 8
 APPLICATION VIEW
 EHF MATED WITH FFSD AND ECF

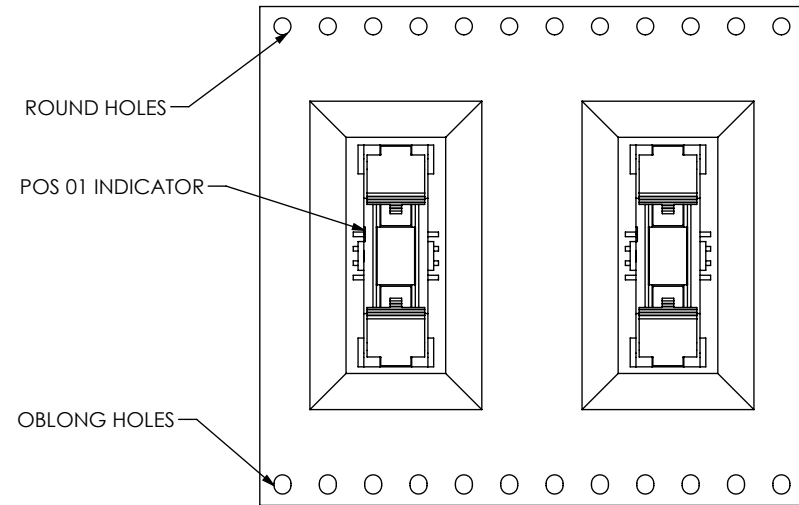

FIG 9
 -TR: TAPE & REEL

PROPRIETARY NOTE
 THIS DOCUMENT CONTAINS CONFIDENTIAL AND PROPRIETARY INFORMATION AND ALL DESIGN, MANUFACTURING, REPRODUCTION, USE, PATENT RIGHTS AND SALES RIGHTS ARE EXPRESSLY RESERVED BY SAMTEC, INC. THIS DOCUMENT SHALL NOT BE DISCLOSED, IN WHOLE OR PART, TO ANY UNAUTHORIZED PERSON OR ENTITY NOR REPRODUCED, TRANSFERRED OR INCORPORATED IN ANY OTHER PROJECT IN ANY MANNER WITHOUT THE EXPRESS WRITTEN CONSENT OF SAMTEC, INC.

DO NOT SCALE DRAWING

SHEET SCALE: 2:1



520 PARK EAST BLVD, NEW ALBANY, IN 47150
 PHONE: 812-944-6733 FAX: 812-948-5047
 e-Mail: info@SAMTEC.com code: 55322



DESCRIPTION: .050 EJECTOR HEADER ASSEMBLY

DWG. NO. EHF-1XX-01-XX-D-XX-XX-XX

BY: ERIC M. 08/17/01 SHEET 3 OF 3

Looking for pricing, stock, or lifecycle information?

Click below to explore more details on WIN SOURCE:

-  [View EHF-110-01-LM-D-SM-LC-A on WIN SOURCE](#)
-  [Samtec Inc. Information](#)

Optimize Your Supply Chain with WIN SOURCE Solutions

-  Global Sourcing Solution
-  Obsolete Management
-  Cost Control Management
-  Shortage Management
-  Alternative Solution
-  Excess Inventory Management