

Features

- Low Noise Figure
- High IP_3
- Single Supply +3 V, +5 V⁶
- RoHS* Compliant SOT-89 Package

Description

M/A-COM Technology's MAAL-010200 broadband gain stage is a GaAs MMIC amplifier in a lead-free SOT-89 surface mount plastic package. The MAAL-010200 employs a monolithic 1-stage self-biased design featuring a convenient 50 Ω input/output impedance that minimizes the number of external components required. Its broadband design provides usable performance from 500 to 3000 MHz. For operation below 500 MHz contact M/A-COM Technology's application group for support.

Functional Block Diagram

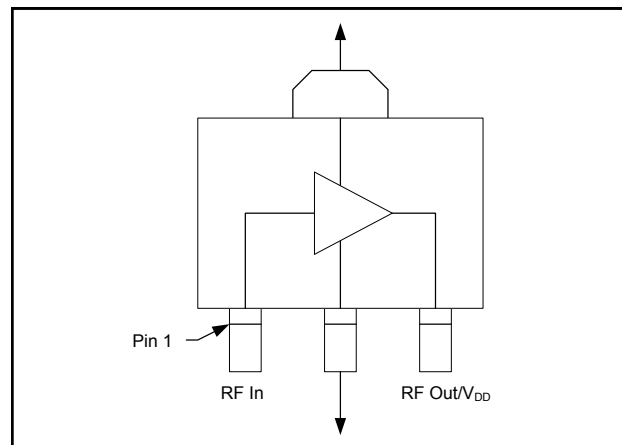

Pin Configuration

Pin	Pin Name	Description
1	RF In	RF Input
2	GND	Ground
3	RF Out/V _{DD}	RF Output & Voltage Bias

Ordering Information ^{1,2}

Part Number	Package
MAAL-010200 -TR3000	3000 piece reel
MAAL-010200-001SMB	Sample Test Board

1. Reference Application Note M513 for reel size information.
2. All sample boards include 5 loose parts.

Absolute Maximum Ratings ^{3,4,5}

Parameter	Absolute Maximum
Gain Compression	6 dB
Voltage	5.5 volts
Operating Temperature	-40 °C to +85 °C
Storage Temperature	-65 °C to +150 °C

3. Exceeding any one or combination of these limits may cause permanent damage to this device.
4. M/A-COM Technology does not recommend sustained operation near these survivability limits.
5. Operating at 5 volts with no drain resistor will require the RF output power to be no greater than 10 dBm.

* Restrictions on Hazardous Substances, European Union Directive 2002/95/EC.

Miniature Broadband Gain Stage 70 - 3000 MHz

Rev. V1

Electrical Specifications: Freq. = 500 - 3000 MHz, $T_A = 25^\circ\text{C}$, $Z_0 = 50 \Omega$

Parameter	Test Conditions	Units	Bias Voltage			
			3 Volts		5 Volts ⁶	
			Min.	Typ.	Max.	Typ.
Gain	F = 0.9 GHz	dB	—	14	—	14
	F = 1.9 GHz		10	11	13	11
	F = 3.0 GHz		—	8	—	8.5
Noise Figure	F = 0.9 GHz	dB	—	1.3	—	1.45
	F = 1.9 GHz		—	1.4	2	1.4
	F = 3.0 GHz		—	1.45	—	1.5
Input Return Loss	F = 0.9 GHz	dB	—	7.5	—	7.5
	F = 1.9 GHz		—	11	—	11
	F = 3.0 GHz		—	14	—	14
Output Return Loss	F = 0.9 GHz	dB	—	19.5	—	20
	F = 1.9 GHz		—	22	—	21.5
	F = 3.0 GHz		—	20	—	23
Output P1dB	500 – 3000 MHz	dBm		17.5		—
Output IP ₃	500 – 3000 MHz	dBm		36		36
Current	—	mA	50	77	100	90

Baseline Application Schematic @ 3V, 5V

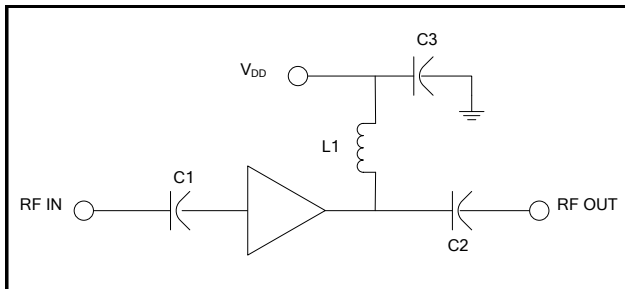

Component List @ 3V, 5V

Part	Value	Case Style	Purpose
C1,C2	39 pF	0402	DC Block
C3	0.1 μF	0402	RF Bypass
L1	12 nH	0402	RF Choke/Tuning

Recommended PCB Configuration @ 3V, 5V

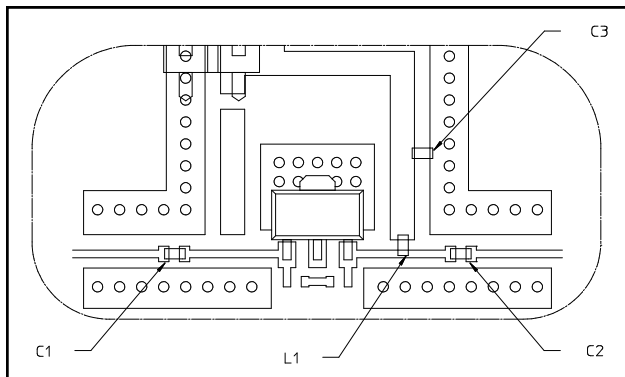

Handling Procedures

The following precautions should be observed to avoid damage:

Static Sensitivity

Gallium Arsenide Integrated Circuits are sensitive to electrostatic discharge (ESD) and can be damaged by static electricity. Proper ESD control techniques should be used when handling these devices.

Typical Performance Curves: $V_{DD} = 3\text{ V}$

Gain

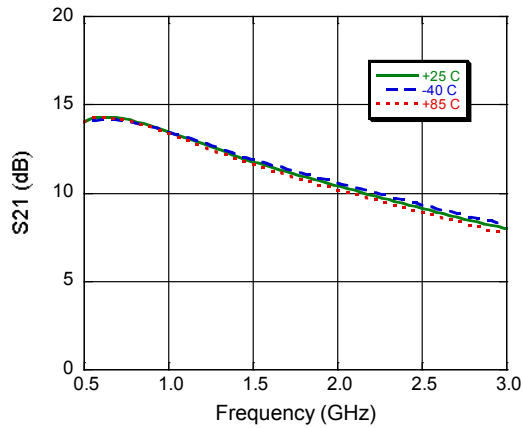

Input Return Loss

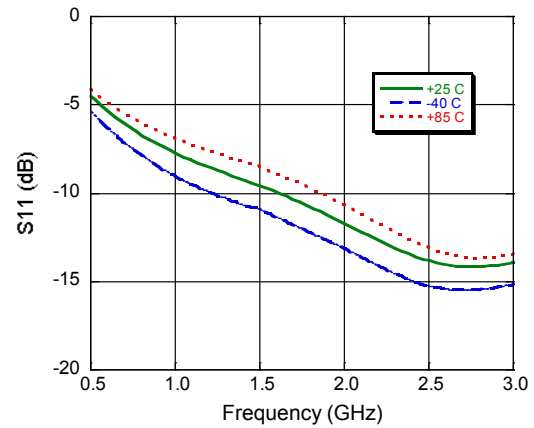

Output Return Loss

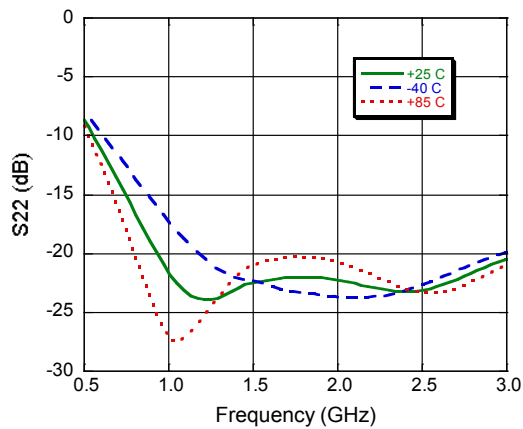

Noise Figure

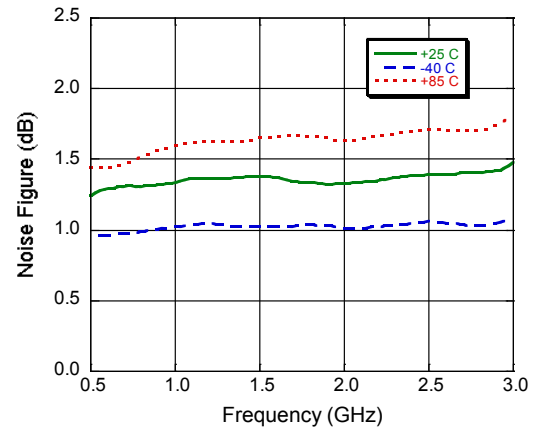

Typical Performance Curves: $V_{DD} = 3\text{ V}$

Output IP3, Input Power @ -12 dBm

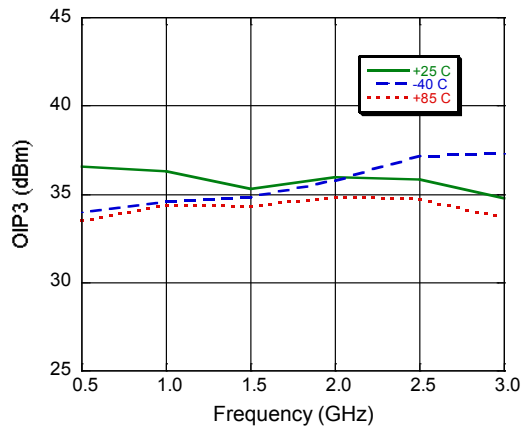

P1dB

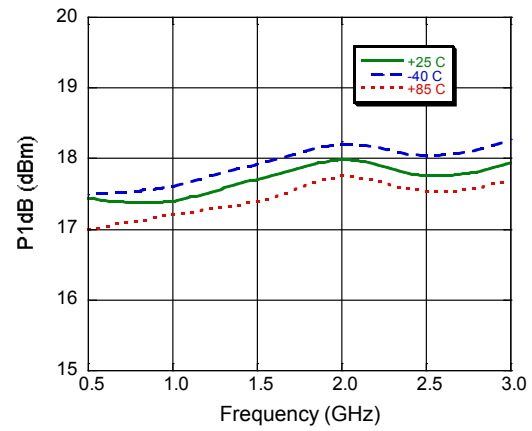

Current

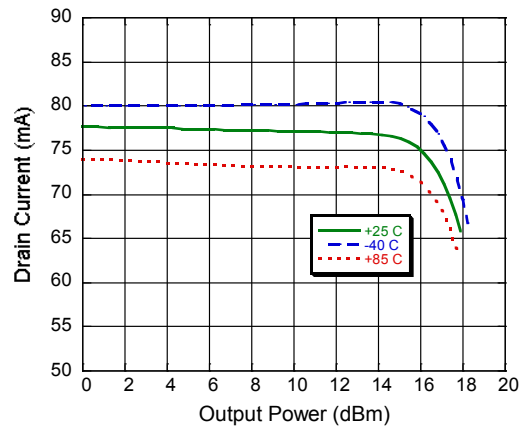

Miniature Broadband Gain Stage 70 - 3000 MHz

Rev. V1

Typical Performance Curves: $V_{DD} = 5 V^6$

Gain

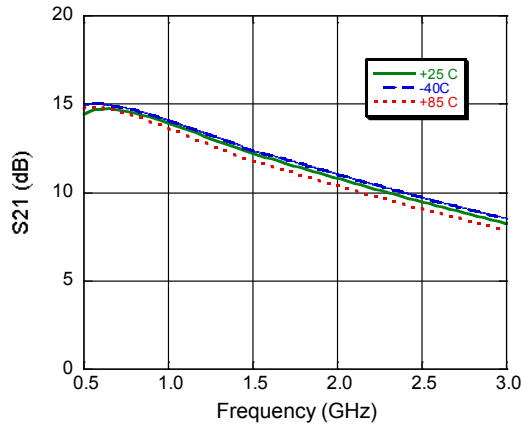

Input Return Loss

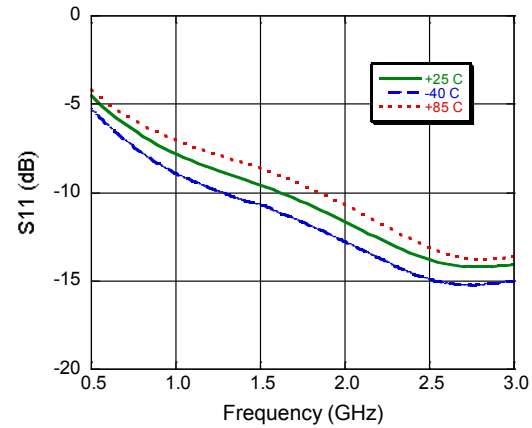

Output Return Loss

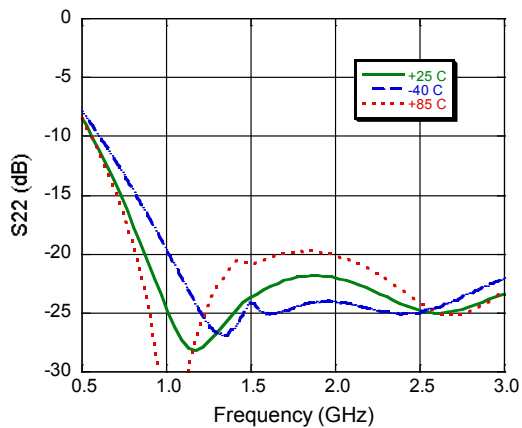

Noise Figure

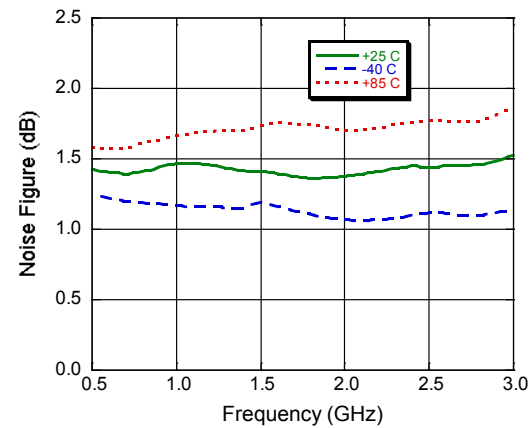

Output IP3, Input Power = -12 dBm

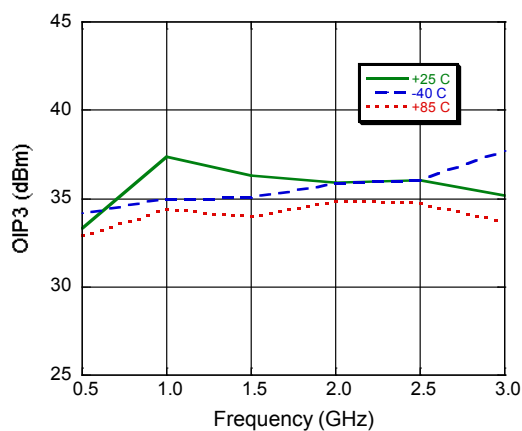

Current

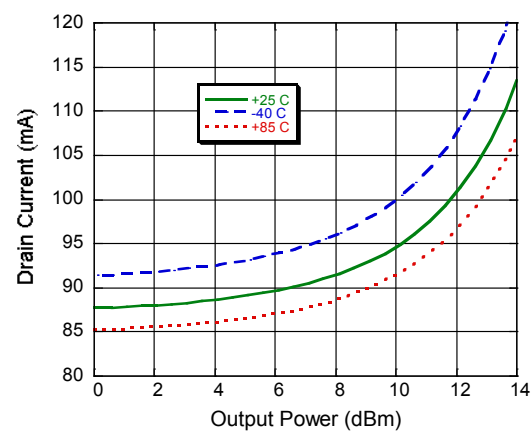

6. This device can run from a single 5 volt supply, but for 1M hour MTTF the output power must be no greater than 10 dBm unless using a series resistor on the drain. See Application note 7 on page 7.

Lead-Free SOT-89†

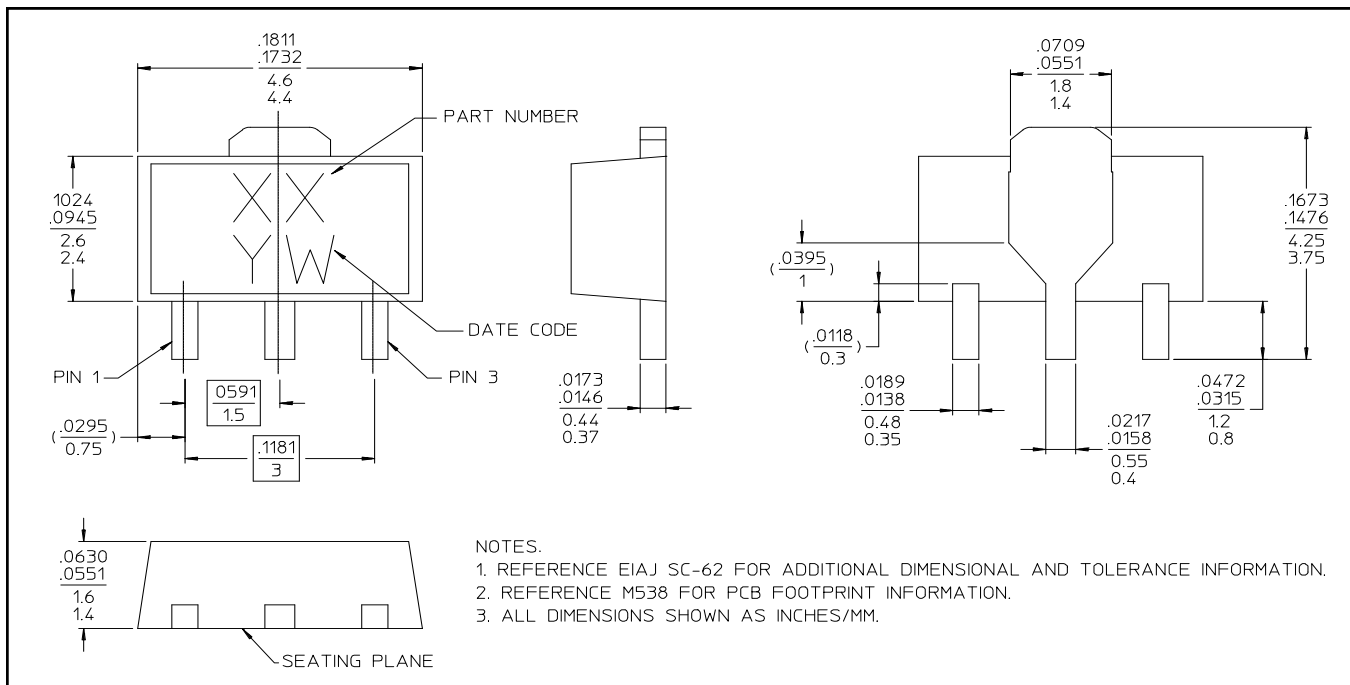

† Reference Application Note M538 for lead-free solder reflow recommendations.
Meets JEDEC moisture sensitivity level 1 requirements.
Plating is 100% matte tin over copper.

5 Volt Application Section for operation above 10 dBm output power

Application Layout Schematic @ 5V ⁷

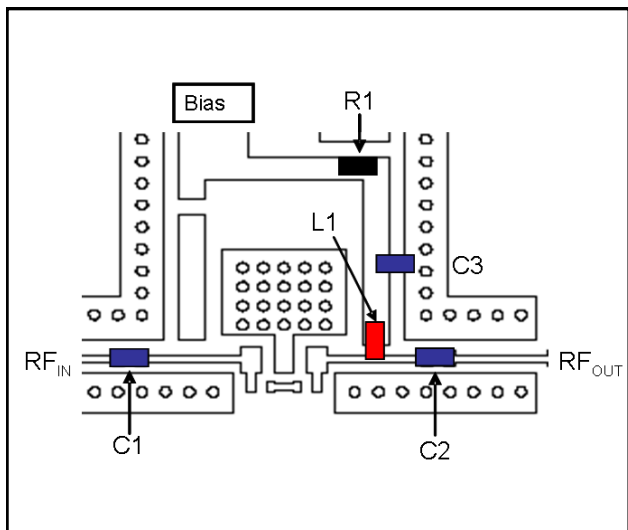

7. The addition of a 27 Ω series resistor on the drain line allows for 5 volt operation above 10 dBm output power, but no greater than 22 dBm of output power.

Component List @ 5V

Part	Value	Case Style	Purpose
C1	39 pF	0402	Input DC Block
C2	39 pF	0402	Output DC Block
C3	0.1 μ F	0402	RF Bypass
L1	12 nH	0805	RF Choke/Tuning
R1	27 Ω	0402	Voltage Drop

Application Schematic @ 5V

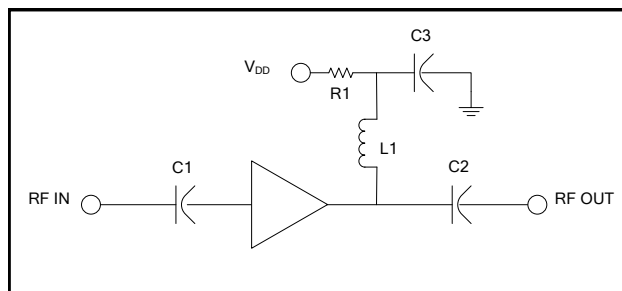

5 Volt Application Section for operation above 10 dBm output power

Typical Performance Curves: $V_{DD} = 5\text{ V}$

Gain

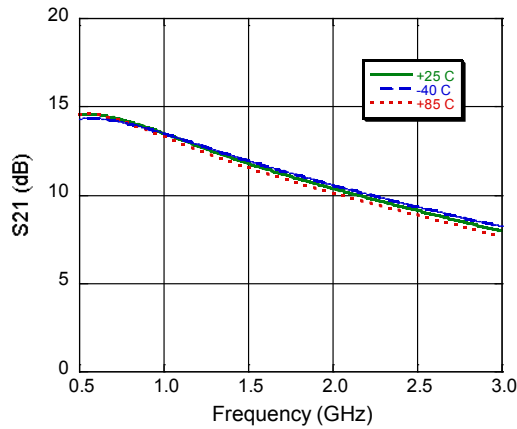

Input Return Loss

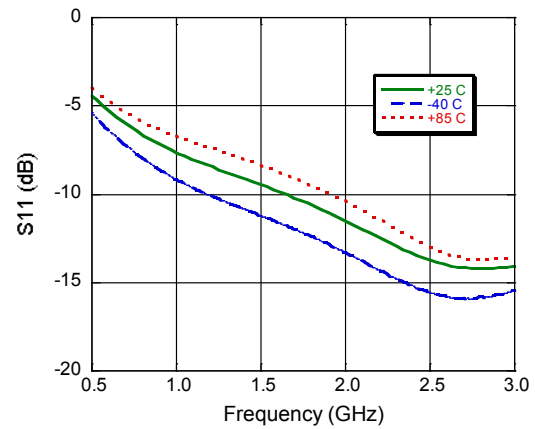

Output Return Loss

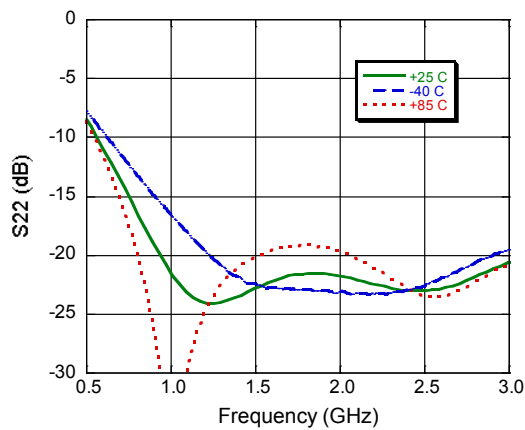

Noise Figure

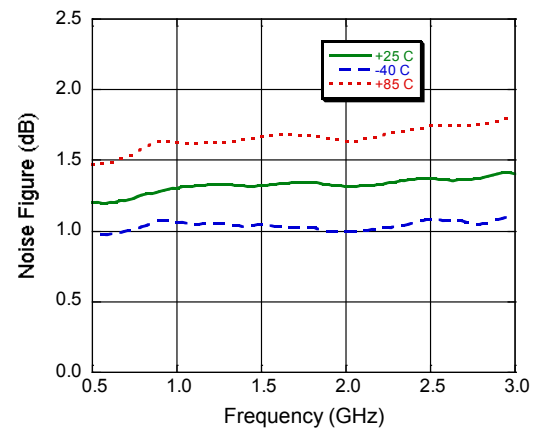

5 Volt Application Section for operation above 10 dBm output power

Typical Performance Curves: $V_{DD} = 5\text{ V}$

Output IP3, Input Power @ -12 dBm

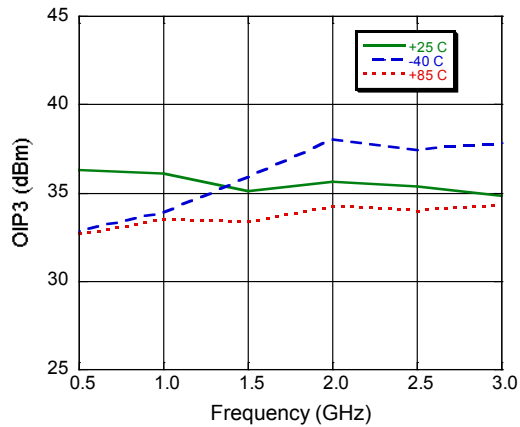

P1dB

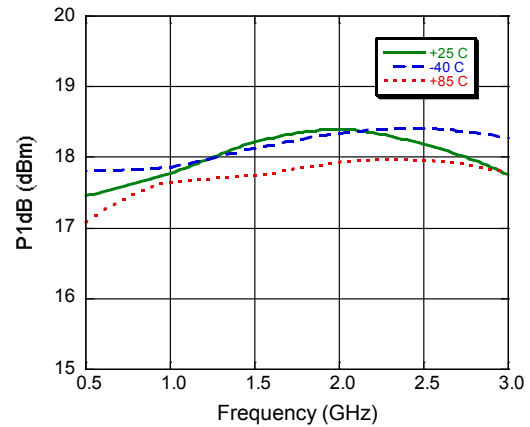

Current

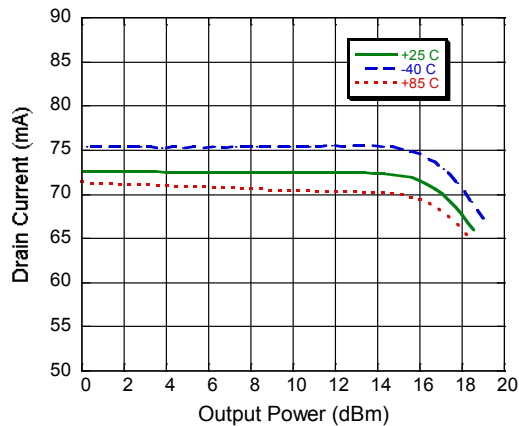

M/A-COM Technology Solutions Inc. All rights reserved.

Information in this document is provided in connection with M/A-COM Technology Solutions Inc ("MACOM") products. These materials are provided by MACOM as a service to its customers and may be used for informational purposes only. Except as provided in MACOM's Terms and Conditions of Sale for such products or in any separate agreement related to this document, MACOM assumes no liability whatsoever. MACOM assumes no responsibility for errors or omissions in these materials. MACOM may make changes to specifications and product descriptions at any time, without notice. MACOM makes no commitment to update the information and shall have no responsibility whatsoever for conflicts or incompatibilities arising from future changes to its specifications and product descriptions. No license, express or implied, by estoppel or otherwise, to any intellectual property rights is granted by this document.

THESE MATERIALS ARE PROVIDED "AS IS" WITHOUT WARRANTY OF ANY KIND, EITHER EXPRESS OR IMPLIED, RELATING TO SALE AND/OR USE OF MACOM PRODUCTS INCLUDING LIABILITY OR WARRANTIES RELATING TO FITNESS FOR A PARTICULAR PURPOSE, CONSEQUENTIAL OR INCIDENTAL DAMAGES, MERCHANTABILITY, OR INFRINGEMENT OF ANY PATENT, COPYRIGHT OR OTHER INTELLECTUAL PROPERTY RIGHT. MACOM FURTHER DOES NOT WARRANT THE ACCURACY OR COMPLETENESS OF THE INFORMATION, TEXT, GRAPHICS OR OTHER ITEMS CONTAINED WITHIN THESE MATERIALS. MACOM SHALL NOT BE LIABLE FOR ANY SPECIAL, INDIRECT, INCIDENTAL, OR CONSEQUENTIAL DAMAGES, INCLUDING WITHOUT LIMITATION, LOST REVENUES OR LOST PROFITS, WHICH MAY RESULT FROM THE USE OF THESE MATERIALS.

MACOM products are not intended for use in medical, lifesaving or life sustaining applications. MACOM customers using or selling MACOM products for use in such applications do so at their own risk and agree to fully indemnify MACOM for any damages resulting from such improper use or sale.

Looking for pricing, stock, or lifecycle information?

Click below to explore more details on WIN SOURCE:

- ⊖ [View MAAL-010200-TR3000 on WIN SOURCE](#)
- ⊖ [M/A-Com Technology Solutions Information](#)

Optimize Your Supply Chain with WIN SOURCE Solutions

- ✓ Global Sourcing Solution
- ✓ Obsolete Management
- ✓ Cost Control Management
- ✓ Shortage Management
- ✓ Alternative Solution
- ✓ Excess Inventory Management