

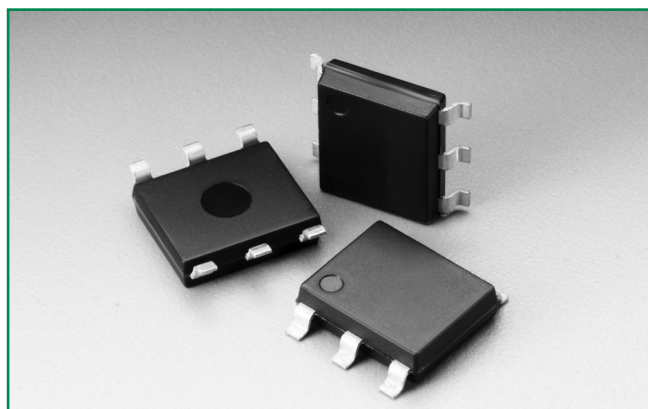



**THE DATASHEET OF
P3203UARP**



SIDACtor® Balanced Series - MS-013



Agency Approvals

| Agency | Agency File Number |
|---|--------------------|
|  | E133083 |

Pinout Designation

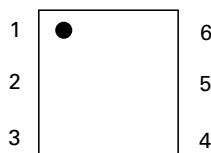

Schematic Symbol

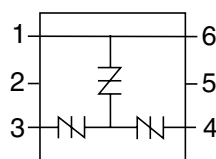

Description

The SIDACtor® Balanced Series MS-013 are designed to protect baseband equipment from overvoltage transients. The patented “Y” configuration ensures balanced overvoltage protection that prevents a longitudinal to differential conversion.

The series provides a single port surface mount solution that enables voice through DS-1 equipment to comply with various global regulatory standards.

Features and Benefits

- Balanced overvoltage protection
- Low voltage overshoot
- Low on-state voltage
- Does not degrade surge capability after multiple surge events within limit.
- Fails short circuit when surged in excess of ratings
- Replaces three discrete components
- Meets UL/IEC 60950-1 creepage and clearance
- RoHS Compliant and Lead-Free
- 2nd level interconnect is Pb-free per IPC/JEDEC J-STD-609A.01

Applicable Global Standards

- TIA-968-A
- TIA-968-B
- ITU K.20/21/45 Enhanced Level
- ITU K.20/21/45 Basic Level
- GR 1089 Inter-building
- GR 1089 Intra-building
- IEC 61000-4-5 2nd edition
- YD/T 1082
- YD/T 993
- YD/T 950

Electrical Characteristics

| Part Number | Part Marking | V_{DRM} @ $I_{DRM}=5\mu A$ | | V_S @ $100V/\mu s$ | | V_T | I_S | I_T | I_H | Capacitance |
|-------------|--------------|------------------------------|-------|----------------------|-------|-------|-------|-------|-------|------------------------------|
| | | V min | V max | V min | V max | | | | | |
| | | Pins 1 & 6-3, 1 & 6-4 | | Pins 3-4 | | | | | | |
| P1553UALxx | P1553UA | 130 | 180 | 130 | 180 | 8 | 800 | 2.2 | 150 | See Capacitance Values table |
| P1803UALxx | P1803UA | 150 | 210 | 150 | 210 | 8 | 800 | 2.2 | 150 | |
| P2103UALxx | P2103UA | 170 | 250 | 170 | 250 | 8 | 800 | 2.2 | 150 | |
| P2353UALxx | P2353UA | 200 | 270 | 200 | 270 | 8 | 800 | 2.2 | 150 | |
| P2703UALxx | P2703UA | 230 | 300 | 230 | 300 | 8 | 800 | 2.2 | 150 | |
| P3203UALxx | P3203UA | 270 | 350 | 270 | 350 | 8 | 800 | 2.2 | 150 | |
| P3403UALxx | P3403UA | 300 | 400 | 300 | 400 | 8 | 800 | 2.2 | 150 | |
| P5103UALxx | P5103UA | 420 | 600 | 420 | 600 | 8 | 800 | 2.2 | 150 | |

Notes:

- Absolute maximum ratings measured at $T_A = +25^\circ C$ (unless otherwise noted).
- Components are bi-directional.
- **XX** = Part Number Suffix: 'TP' (Tube Pack) or 'RP' (Reel Pack).

Table continues on next page.

Electrical Characteristics (continued)

| Part Number | Part Marking | V_{DRM} @ $I_{DRM}=5\mu A$ | V_S @ 100V/ μs | V_{DRM} @ $I_{DRM}=5\mu A$ | V_S @ 100V/ μs | V_T | I_S | I_T | I_H | Capacitance |
|-------------|--------------|---------------------------------|--------------------------|---------------------------------|--------------------------|-------|--------|-------|--------|------------------------------------|
| | | V min | V max | V min | V max | V max | mA max | A max | mA min | |
| | | Pins 1 & 6-3, 1 & 6-4 | | Pins 3-4 | | | | | | |
| P1553UBLxx | P1553UB | 130 | 180 | 130 | 180 | 8 | 800 | 2.2 | 150 | See Capacitance Values table |
| P1803UBLxx | P1803UB | 150 | 210 | 150 | 210 | 8 | 800 | 2.2 | 150 | |
| P2103UBLxx | P2103UB | 170 | 250 | 170 | 250 | 8 | 800 | 2.2 | 150 | |
| P2353UBLxx | P2353UB | 200 | 270 | 200 | 270 | 8 | 800 | 2.2 | 150 | |
| P2703UBLxx | P2703UB | 230 | 300 | 230 | 300 | 8 | 800 | 2.2 | 150 | |
| P3203UBLxx | P3203UB | 270 | 350 | 270 | 350 | 8 | 800 | 2.2 | 150 | |
| P3403UBLxx | P3403UB | 300 | 400 | 300 | 400 | 8 | 800 | 2.2 | 150 | |
| P5103UBLxx | P5103UB | 420 | 600 | 420 | 600 | 8 | 800 | 2.2 | 150 | |
| P1553UCLxx | P1553UC | 130 | 180 | 130 | 180 | 8 | 800 | 2.2 | 150 | |
| P1803UCLxx | P1803UC | 150 | 210 | 150 | 210 | 8 | 800 | 2.2 | 150 | |
| P2103UCLxx | P2103UC | 170 | 250 | 170 | 250 | 8 | 800 | 2.2 | 150 | |
| P2353UCLxx | P2353UC | 200 | 270 | 200 | 270 | 8 | 800 | 2.2 | 150 | |
| P2703UCLxx | P2703UC | 230 | 300 | 230 | 300 | 8 | 800 | 2.2 | 150 | |
| P3203UCLxx | P3203UC | 270 | 350 | 270 | 350 | 8 | 800 | 2.2 | 150 | |
| P3403UCLxx | P3403UC | 300 | 400 | 300 | 400 | 8 | 800 | 2.2 | 150 | |
| P5103UCLxx | P5103UC | 420 | 600 | 420 | 600 | 8 | 800 | 2.2 | 150 | |

Capacitance Values

| Part Number | Pin 3-4 Tip-Ring | | Pins 1 & 6-3, 1 & 6-4 Tip-Ground, Ring-Ground | |
|-------------|---------------------|--------|--|--------|
| | pF min | pF max | pF min | pF max |
| P1553UALxx | 20 | 95 | 10 | 60 |
| P1803UALxx | 20 | 85 | 10 | 55 |
| P2103UALxx | 15 | 85 | 10 | 55 |
| P2353UALxx | 15 | 75 | 10 | 50 |
| P2703UALxx | 15 | 75 | 10 | 50 |
| P3203UALxx | 15 | 70 | 10 | 45 |
| P3403UALxx | 15 | 65 | 10 | 45 |
| P5103UALxx | 10 | 60 | 10 | 40 |
| P1553UBLxx | 25 | 95 | 15 | 60 |
| P1803UBLxx | 25 | 85 | 15 | 55 |
| P2103UBLxx | 20 | 85 | 15 | 55 |
| P2353UBLxx | 20 | 75 | 15 | 50 |
| P2703UBLxx | 20 | 75 | 10 | 50 |
| P3203UBLxx | 20 | 70 | 10 | 45 |
| P3403UBLxx | 15 | 65 | 10 | 45 |
| P5103UBLxx | 15 | 60 | 10 | 40 |
| P1553UCLxx | 30 | 95 | 20 | 60 |
| P1803UCLxx | 30 | 85 | 15 | 55 |
| P2103UCLxx | 30 | 85 | 15 | 55 |
| P2353UCLxx | 25 | 75 | 15 | 50 |
| P2703UCLxx | 25 | 75 | 15 | 50 |
| P3203UCLxx | 25 | 70 | 15 | 45 |
| P3403UCLxx | 20 | 65 | 15 | 45 |
| P5103UCLxx | 20 | 60 | 10 | 40 |

Note: Off-state capacitance (C_o) is measured at 1 MHz with a 2 V bias.

Additional Information



Datasheet



Resources



Samples

Surge Ratings

| Series | I_{PP} | | | | | | | | | | I_{TSM} 50/60 Hz | di/dt |
|--------|--|--|--|--|--|--|--|--|---|-------|-----------------------|-------|
| | 0.2/310 ¹ 0.5/700 ² | 2/10 ¹ 2/10 ² | 8/20 ¹ 1.2/50 ² | 10/160 ¹ 10/160 ² | 10/560 ¹ 10/560 ² | 5/320 ¹ 9/720 ² | 10/360 ¹ 10/360 ² | 10/1000 ¹ 10/1000 ² | 5/310 ¹ 10/700 ² | A min | | |
| | A min | A min | A min | A min | A min | A min | A min | A min | A min | A min | | |
| A | 20 | 150 | 150 | 90 | 50 | 75 | 75 | 45 | 75 | 20 | 500 | |
| B | 25 | 250 | 250 | 150 | 100 | 100 | 125 | 80 | 100 | 25 | 500 | |
| C | 50 | 500 | 400 | 200 | 150 | 200 | 175 | 100 | 200 | 50 | 500 | |

Notes:
 1 Current waveform in μ s
 2 Voltage waveform in μ s
 - Peak pulse current rating (I_{PP}) is repetitive and guaranteed for the life of the product that remains in thermal equilibrium.
 - I_{PP} ratings applicable over temperature range of -40 to $+85^\circ\text{C}$
 - The component must initially be in thermal equilibrium with $-40^\circ\text{C} \leq T_J \leq +150^\circ\text{C}$

Thermal Considerations

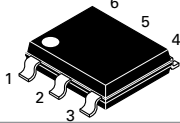
| Package | Symbol | Parameter | Value | Unit |
|--|-----------------|---|-------------|---------------------------|
| Modified MS-013  | T_J | Operating Junction Temperature Range | -40 to +150 | $^\circ\text{C}$ |
| | T_S | Storage Temperature Range | -65 to +150 | $^\circ\text{C}$ |
| | $R_{\theta JA}$ | Thermal Resistance: Junction to Ambient | 60 | $^\circ\text{C}/\text{W}$ |

V-I Characteristics

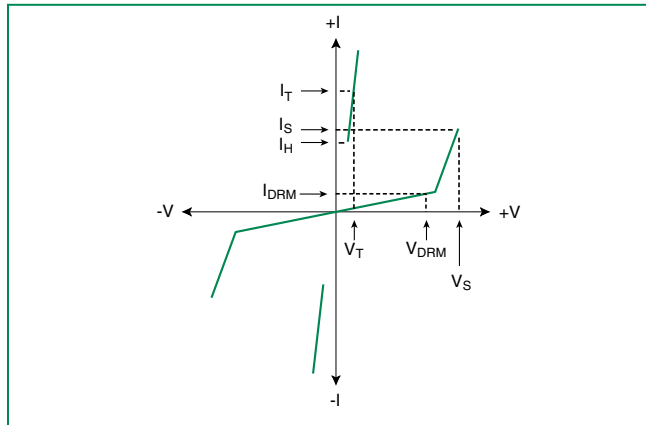

$t_r \times t_d$ Pulse Waveform

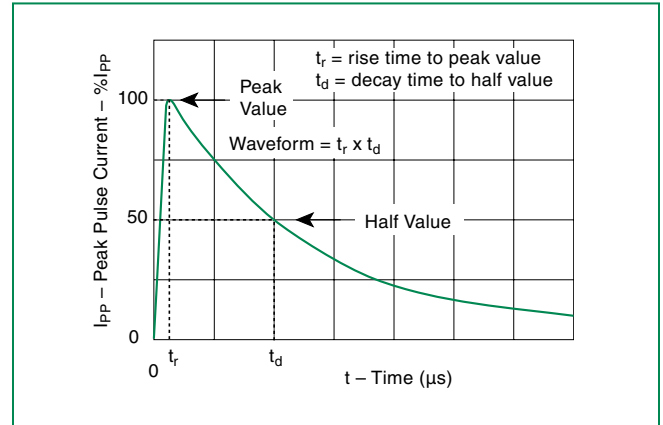

Normalized V_S Change vs. Junction Temperature

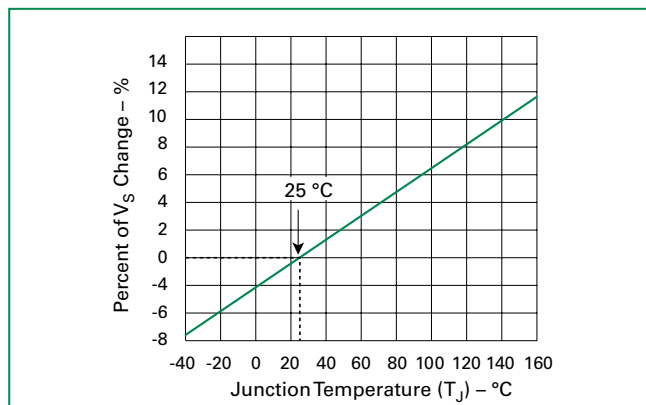

Normalized DC Holding Current vs. Case Temperature

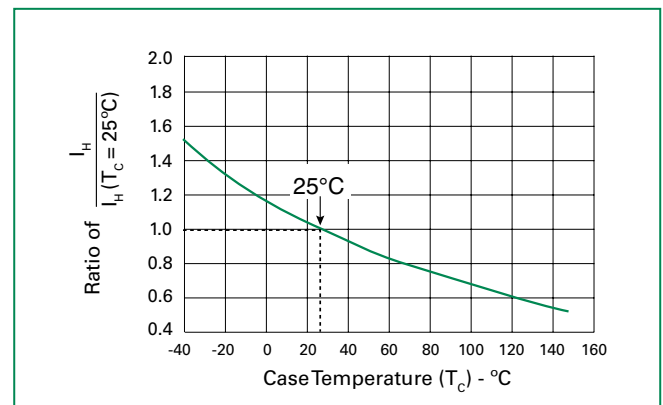

Soldering Parameters

| | | |
|--|-----------------------------------|-------------------------------|
| Reflow Condition | | Pb-Free assembly (see Fig. 1) |
| Pre Heat | -Temperature Min ($T_{s(min)}$) | +150°C |
| | -Temperature Max ($T_{s(max)}$) | +200°C |
| | -Time (Min to Max) (t_s) | 60-180 secs. |
| Average ramp up rate (Liquidus Temp (T_L) to peak) | | 3°C/sec. Max. |
| $T_{s(max)}$ to T_L - Ramp-up Rate | | 3°C/sec. Max. |
| Reflow | -Temperature (T_L) (Liquidus) | +217°C |
| | -Temperature (t_L) | 60-150 secs. |
| Peak Temp (T_p) | | +260(+0/-5)°C |
| Time within 5°C of actual PeakTemp (t_p) | | 30 secs. Max. |
| Ramp-down Rate | | 6°C/sec. Max. |
| Time 25°C to Peak Temp (T_p) | | 8 min. Max. |
| Do not exceed | | +260°C |

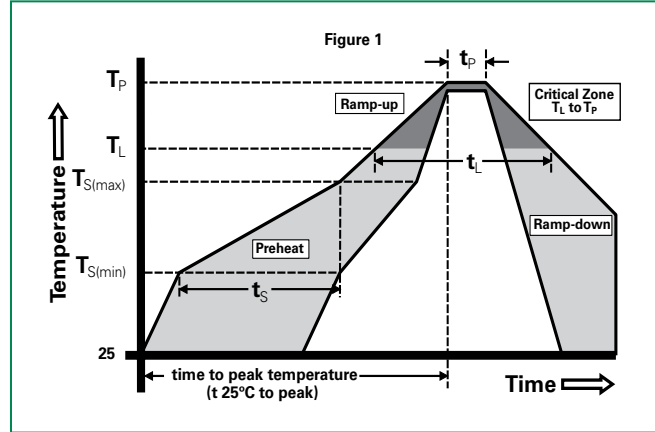

Physical Specifications

| | |
|------------------------|---|
| Lead Material | Copper Alloy |
| Terminal Finish | 100% Matte-Tin Plated |
| Body Material | UL Recognized epoxy meeting flammability classification V-0 |

Environmental Specifications

| | |
|---|--|
| High Temp Voltage Blocking | 80% Rated V_{DRM} ($V_{AC Peak}$) +125°C or +150°C, 504 or 1008 hrs. MIL-STD-750 (Method 1040) JEDEC, JESD22-A-101 |
| Temp Cycling | -65°C to +150°C, 15 min. dwell, 10 up to 100 cycles. MIL-STD-750 (Method 1051) EIA/JEDEC, JESD22-A104 |
| Biased Temp & Humidity | 52 V_{DC} (+85°C) 85%RH, 504 up to 1008 hrs. EIA/JEDEC, JESD22-A-101 |
| High Temp Storage | +150°C 1008 hrs. MIL-STD-750 (Method 1031) JEDEC, JESD22-A-101 |
| Low Temp Storage | -65°C, 1008 hrs. |
| Thermal Shock | 0°C to +100°C, 5 min. dwell, 10 sec. transfer, 10 cycles. MIL-STD-750 (Method 1056) JEDEC, JESD22-A-106 |
| Autoclave (Pressure Cooker Test) | +121°C, 100%RH, 2atm, 24 up to 168 hrs. EIA/JEDEC, JESD22-A-102 |
| Resistance to Solder Heat | +260°C, 30 secs. MIL-STD-750 (Method 2031) |
| Moisture Sensitivity Level | 85%RH, +85°C, 168 hrs., 3 reflow cycles (+260°C Peak). JEDEC-J-STD-020, Level 1 |

Part Marking

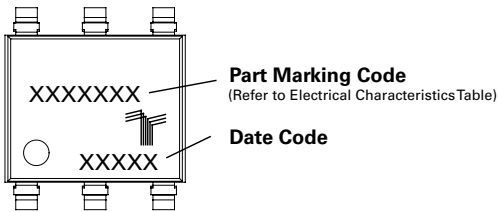

Part Numbering

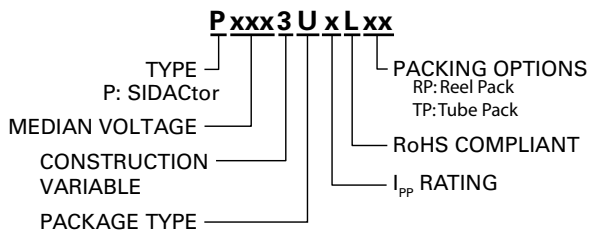

Packing Options

| Package Type | Description | Quantity | Added Suffix | Industry Standard |
|--------------|--|-------------------|--------------|-------------------|
| U | Modified MS-013 6-pin Tape and Reel Pack | 1500 | RP | EIA-481-D |
| | Modified MS-013 6-pin Tube Pack | 500 (50 per tube) | TP | N/A |

Dimensions — MS-013

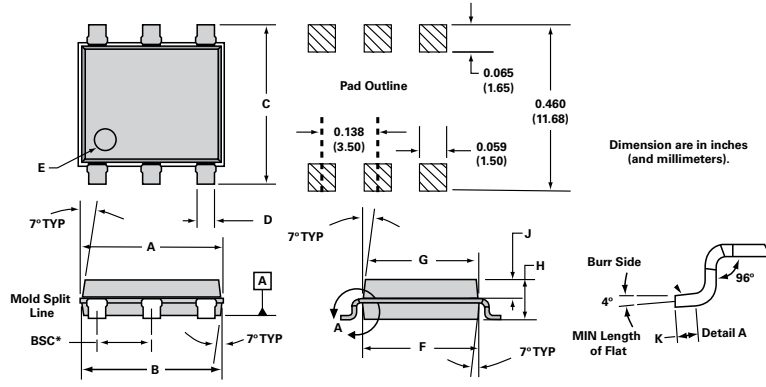

| Dimensions | Inches | | Millimeters | |
|-------------|--------|-------|-------------|-------|
| | Min | Max | Min | Max |
| A | 0.360 | 0.364 | 9.14 | 9.25 |
| B | 0.352 | 0.356 | 8.94 | 9.04 |
| C | 0.400 | 0.412 | 10.16 | 10.46 |
| D | 0.043 | 0.045 | 1.09 | 1.13 |
| E | 0.047 | 0.055 | 1.19 | 1.40 |
| F | 0.293 | 0.297 | 7.44 | 7.54 |
| G | 0.289 | 0.293 | 7.34 | 7.44 |
| H | 0.089 | 0.093 | 2.26 | 2.36 |
| J | 0.041 | 0.049 | 1.04 | 1.24 |
| K | 0.020 | | 0.51 | |
| BSC* | 0.133 | 0.143 | 3.38 | 3.63 |

* BSC = Basic Spacing between Centers

Tape and Reel Specification — MS-013

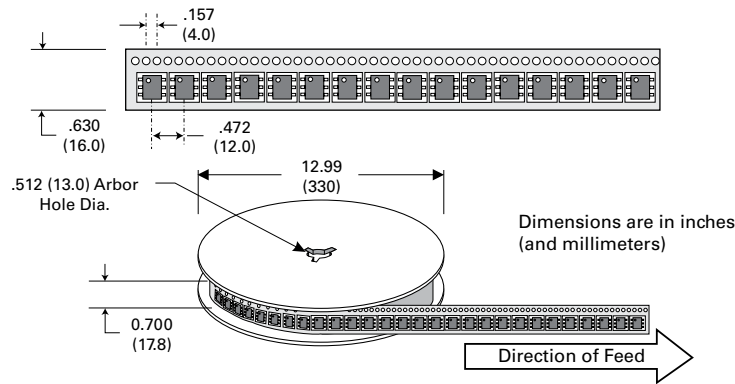

Tube Pack Specification — MS-013

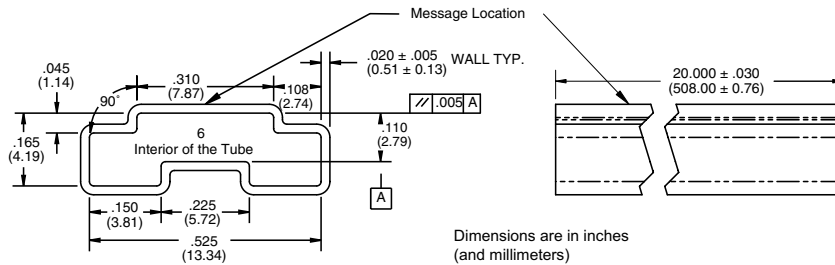

Disclaimer Notice - Information furnished is believed to be accurate and reliable. However, users should independently evaluate the suitability of and test each product selected for their own applications. Littelfuse products are not designed for, and may not be used in, all applications. Read complete Disclaimer Notice at www.littelfuse.com/disclaimer-electronics.

Looking for pricing, stock, or lifecycle information?

Click below to explore more details on WIN SOURCE:

 [View P3203UARP on WIN SOURCE](#)

 [Littelfuse Inc. Information](#)

Optimize Your Supply Chain with WIN SOURCE Solutions

-  Global Sourcing Solution
-  Obsolete Management
-  Cost Control Management
-  Shortage Management
-  Alternative Solution
-  Excess Inventory Management