



**THE DATASHEET OF
MMSZ4692-TP**





Micro Commercial Components



Micro Commercial Components
20736 Marilla Street Chatsworth
CA 91311
Phone: (818) 701-4933
Fax: (818) 701-4939

**MMSZ4678
THRU
MMSZ4716**

**500mW Silicon
Zener Diodes**

Features

- Zener Voltage 1.8V-39V
- Very Sharp Reverse Characteristic
- VZ – tolerance $\pm 5\%$
- High Reliability
- Epoxy meets UL 94 V-0 flammability rating
- Moisture Sensitivity Level 1

Mechanical Data

- Halogen free available upon request by adding suffix "-HF"
- Polarity: Cathode indicated by polarity band
- Lead Free Finish/RoHS Compliant ("P" Suffix designates RoHS Compliant. See ordering information)

Maximum Ratings

	Symbol	Value	Units
Max. Steady State Power Dissipation at $T_L < 75^\circ\text{C}$, Lead Length=3/8"	P_D	500	mW
Junction Temperature	T_J	150	$^\circ\text{C}$
Storage Temperature Range	T_{STG}	-55 to 150	$^\circ\text{C}$
Thermal Resistance(Junction to Ambient)	R_{thJA}	340	K/W

Electrical Characteristics @ 25°C Unless Otherwise Specified

	Symbol	Maximum	Unit
Max. Forward Voltage @ $I_F=10\text{mA}$	V_F	0.95	V

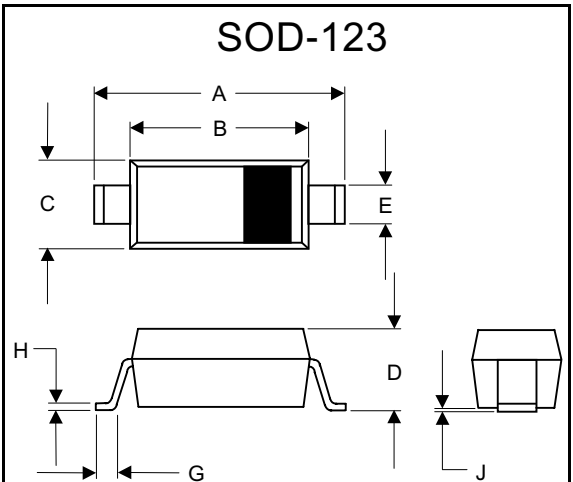

DIM	DIMENSIONS				NOTE
	INCHES		MM		
	MIN	MAX	MIN	MAX	
A	.140	.152	3.55	3.85	
B	.100	.112	2.55	2.85	
C	.055	.071	1.40	1.80	
D	-----	.053	-----	1.35	
E	.012	.031	0.30	.78	
G	.006	-----	0.15	-----	
H	-----	.01	-----	.25	
J	-----	.006	-----	.15	

SUGGESTED SOLDER PAD LAYOUT

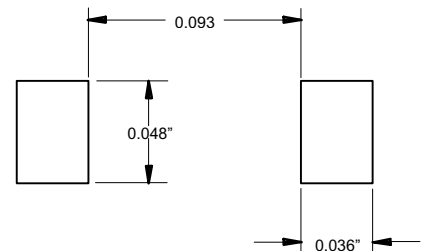

MMSZ4678 thru MMSZ4716

Electrical Characteristics (T_i= 30°C Unless Otherwise Noted, V_F=0.95V Max @ I_F=10mA for all types)

Device	Zener Voltage			@I _{ZT}	Leakage Current		Device Marking
	V _Z (Volts)				I _R @V _R		
	Min	Nom	Max	u A	u A	Volts	
MMSZ4678	1.71	1.8	1.89	50	7.5	1.0	CC
MMSZ4679	1.90	2.0	2.10	50	5.0	1.0	CD
MMSZ4680	2.09	2.2	2.31	50	4.0	1.0	CE
MMSZ4681	2.28	2.40	2.52	50	2.0	1.0	CF
MMSZ4682	2.565	2.7	2.835	50	1.0	1.0	CH
MMSZ4683	2.85	3.0	3.15	50	0.8	1.0	CJ
MMSZ4684	3.135	3.3	3.465	50	7.5	1.5	CK
MMSZ4685	3.42	3.6	3.78	50	7.5	2.0	CM
MMSZ4686	3.705	3.9	4.095	50	5.0	2.0	CN
MMSZ4687	4.085	4.3	4.515	50	4.0	2.0	CP
MMSZ4688	4.465	4.7	4.935	50	10	3.0	CT
MMSZ4689	4.845	5.1	5.355	50	10	3.0	CU
MMSZ4690	5.32	5.6	5.88	50	10	4.0	CV
MMSZ4691	5.89	6.2	6.51	50	10	5.0	CA
MMSZ4692	6.46	6.8	7.14	50	10	5.1	CX
MMSZ4693	7.125	7.5	7.875	50	10	5.7	CY
MMSZ4694	7.79	8.2	8.61	50	1	6.2	CZ
MMSZ4695	8.265	8.7	9.135	50	1	6.6	DC
MMSZ4696	8.645	9.1	9.555	50	1	6.9	DD
MMSZ4697	9.50	10	10.5	50	1	7.6	DE
MMSZ4698	10.45	11	11.55	50	0.05	8.4	DF
MMSZ4699	11.40	12	12.6	50	0.05	9.1	DH
MMSZ4700	12.35	13	13.65	50	0.05	9.8	DJ
MMSZ4701	13.30	14	14.7	50	0.05	10.6	DK
MMSZ4702	14.25	15	15.75	50	0.05	11.4	DM
MMSZ4703	15.20	16	16.8	50	0.05	12.1	DN
MMSZ4704	16.15	17	17.85	50	0.05	12.9	DP
MMSZ4705	17.10	18	18.9	50	0.05	13.6	DT
MMSZ4706	18.05	19	19.95	50	0.05	14.4	DU
MMSZ4707	19.00	20	21	50	0.01	15.2	DV
MMSZ4708	20.9	22	23.1	50	0.01	16.7	DA
MMSZ4709	22.8	24	25.2	50	0.01	18.2	DX
MMSZ4710	23.75	25	26.25	50	0.01	19.0	DY
MMSZ4711	25.65	27	28.35	50	0.01	20.4	EA
MMSZ4712	26.6	28	29.4	50	0.01	21.2	EC
MMSZ4713	28.5	30	31.5	50	0.01	22.8	ED
MMSZ4714	31.35	33	34.65	50	0.01	25.0	EE
MMSZ4715	34.2	36	37.8	50	0.01	27.3	EF
MMSZ4716	37.05	39	40.95	50	0.01	29.6	EH

MMSZ4678 thru MMSZ4716

TYPICAL CHARACTERISTICS

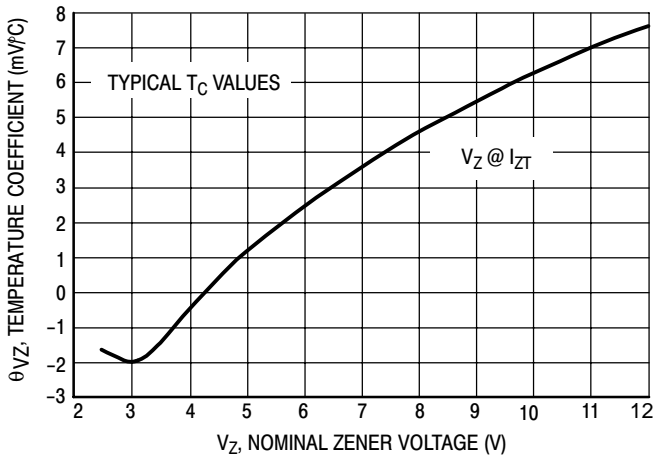

Figure 1. Temperature Coefficients
(Temperature Range -55°C to +150°C)

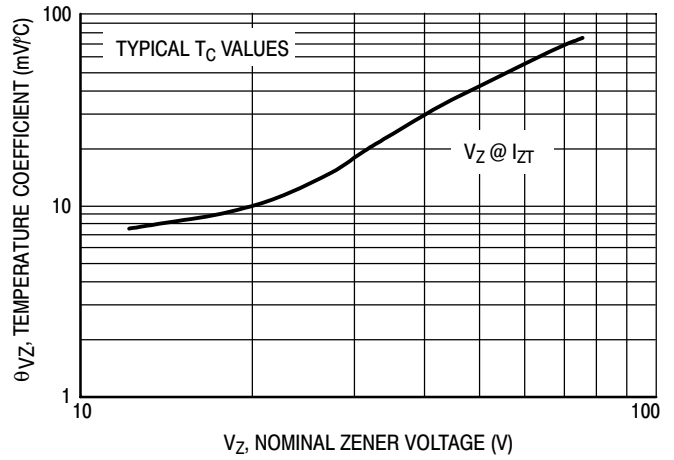

Figure 2. Temperature Coefficients
(Temperature Range -55°C to +150°C)

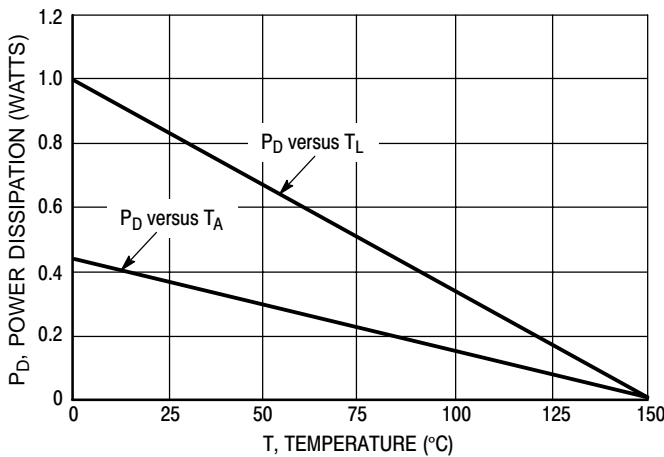

Figure 3. Steady State Power Derating

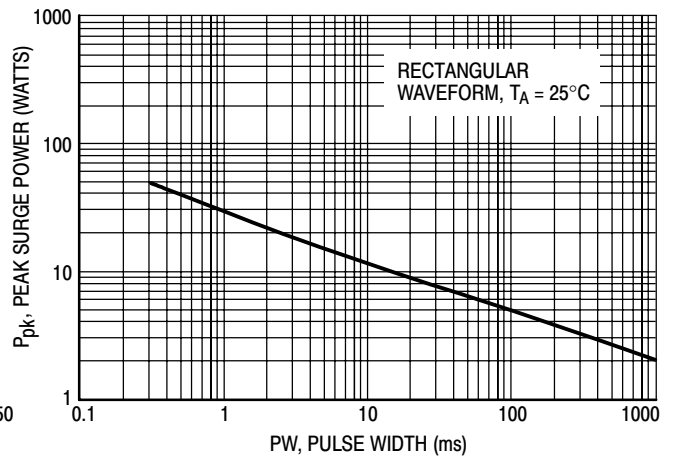

Figure 4. Maximum Nonrepetitive Surge Power

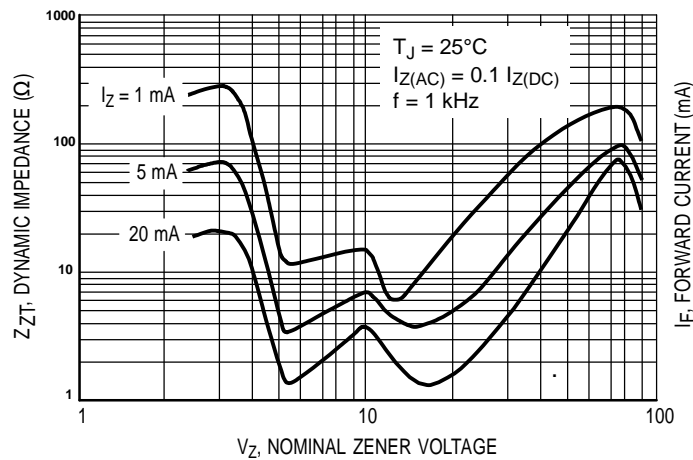

Figure 5. Effect of Zener Voltage on Zener Impedance

MMSZ4678 thru MMSZ4716

TYPICAL CHARACTERISTICS

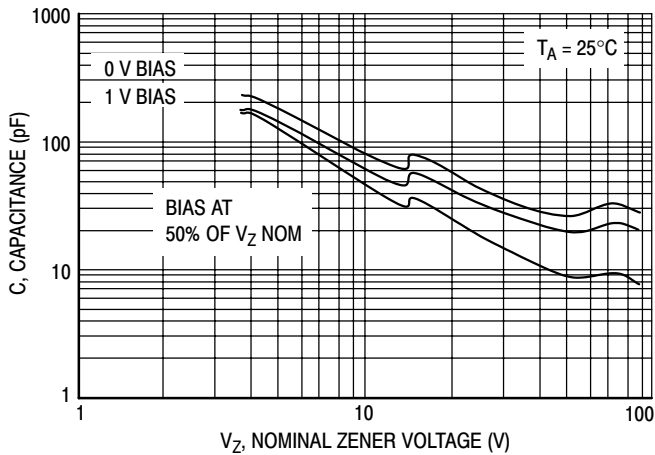

Figure 7. Typical Capacitance

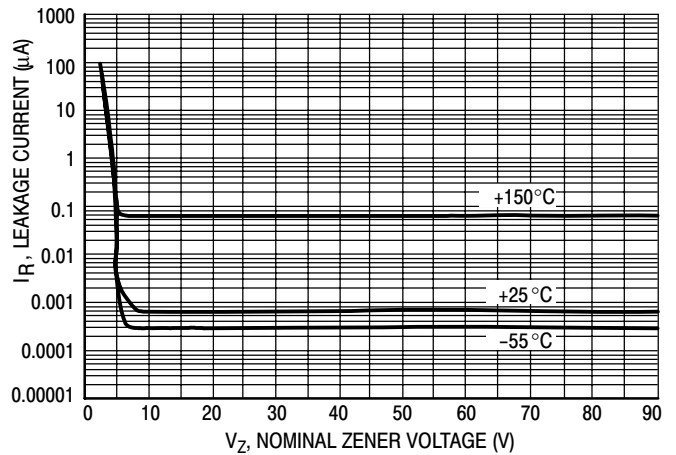

Figure 8. Typical Leakage Current

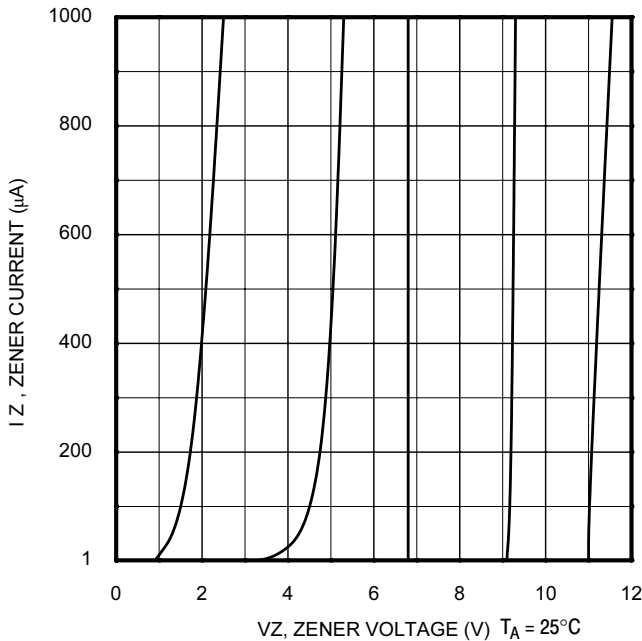

Figure 9. Zener Voltage versus Zener Current (V_Z Up to 12 V)

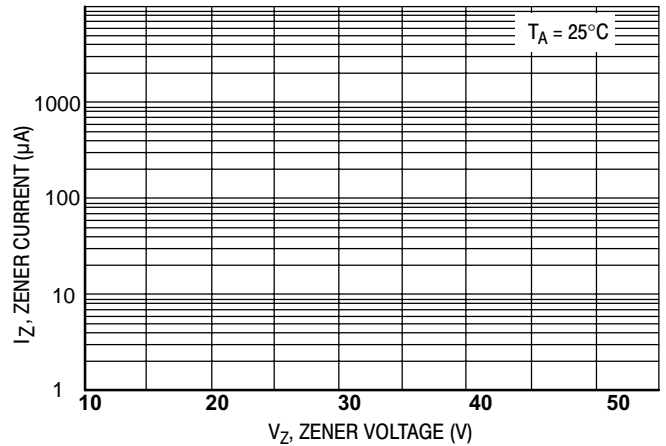

Figure 10. Zener Voltage versus Zener Current (12 V to 39 V)



Ordering Information :

Device	Packing
Part Number-TP	Tape&Reel: 3Kpcs/Reel

Note : Adding "-HF" suffix for halogen free, eg. Part Number-TP-HF

IMPORTANT NOTICE
<p>Micro Commercial Components Corp. reserves the right to make changes without further notice to any product herein to make corrections, modifications , enhancements , improvements , or other changes . Micro Commercial Components Corp . does not assume any liability arising out of the application or use of any product described herein; neither does it convey any license under its patent rights ,nor the rights of others . The user of products in such applications shall assume all risks of such use and will agree to hold Micro Commercial Components Corp . and all the companies whose products are represented on our website, harmless against all damages.</p>
LIFE SUPPORT
<p>MCC's products are not authorized for use as critical components in life support devices or systems without the express written approval of Micro Commercial Components Corporation.</p>
CUSTOMER AWARENESS
<p>Counterfeiting of semiconductor parts is a growing problem in the industry. Micro Commercial Components (MCC) is taking strong measures to protect ourselves and our customers from the proliferation of counterfeit parts. MCC strongly encourages customers to purchase MCC parts either directly from MCC or from Authorized MCC Distributors who are listed by country on our web page cited below. Products customers buy either from MCC directly or from Authorized MCC Distributors are genuine parts, have full traceability, meet MCC's quality standards for handling and storage. MCC will not provide any warranty coverage or other assistance for parts bought from Unauthorized Sources. MCC is committed to combat this global problem and encourage our customers to do their part in stopping this practice by buying direct or from authorized distributors.</p>

Looking for pricing, stock, or lifecycle information?

Click below to explore more details on WIN SOURCE:

- ⊖ [View MMSZ4692-TP on WIN SOURCE](#)
- ⊖ [Micro Commercial Co](#) Information

Optimize Your Supply Chain with WIN SOURCE Solutions

- ✓ Global Sourcing Solution
- ✓ Obsolete Management
- ✓ Cost Control Management
- ✓ Shortage Management
- ✓ Alternative Solution
- ✓ Excess Inventory Management