





# +3V/+5V, 250MHz, SOT23 ADC Buffer Amplifiers with High-Speed Disable

## General Description

The MAX4285/MAX4286 single and MAX4287/MAX4288/MAX4387/MAX4388 dual ADC buffer amplifiers feature high-speed performance and single +3V supply operation. The MAX4285/MAX4286/MAX4288 and MAX4388 offer a disable feature that reduces power-supply current and places the outputs in a high-impedance state. All six devices operate from a +2.85V to +6.5V single supply or from  $\pm 1.425V$  to  $\pm 3.25V$  dual supplies. The common-mode input voltage range extends to the negative power-supply rail (ground in single-supply applications).

These devices require 20mA of quiescent supply current per amplifier while achieving a 250MHz -3dB bandwidth and a 350V/ $\mu$ s slew rate. The combination of an 8ns (to 0.1%) settling time, 88dBc (f = 5MHz) of SFDR, and up to 100mA output drive makes these amplifiers ideal for high-speed ADC drivers for communications and instrumentation applications. In addition, when disabled, their high output impedance makes them ideal for multiplexing applications.

The MAX4285/MAX4286 are available in space-saving 6-pin SOT23 and 8-pin SO packages. The MAX4287/MAX4387 come in 8-pin  $\mu$ MAX and 8-pin SO packages, while the MAX4288/MAX4388 come in 10-pin  $\mu$ MAX and 14-pin SO packages.

## Applications

High-Speed ADC Drivers  
Communications Equipment  
Instrumentation  
CCD Imaging Systems  
Ultrasound

Typical Operating Circuit appears at end of data sheet.

Pin Configurations appear at end of data sheet.

## Features

- ◆ High Speed at 3V
  - 250MHz -3dB Bandwidth (MAX4285/87/88)
  - 150MHz -3dB Bandwidth (MAX4286, MAX4387/88)
  - 350V/ $\mu$ s Slew Rate
- ◆ +2.85V to +6.5V Single-Supply Operation
- ◆ Input Common-Mode Range Extends to  $V_{EE}$
- ◆ Low Distortion at 5MHz
  - 88dBc SFDR
- ◆ High Output Current Drive: -106mA to +77mA
- ◆ 6ns Settling Time to 0.1%
- ◆ High-Speed Enable/Disable
  - 40ns Enable Time
  - 50ns Disable Time
  - High Output Impedance
- ◆ Space-Saving SOT23 and  $\mu$ MAX Packages

## Ordering Information

PART	TEMP. RANGE	PIN-PACKAGE	SOT TOP MARK
MAX4285EUT-T	-40°C to +85°C	6 SOT23-6	AABQ
MAX4285ESA	-40°C to +85°C	8 SO	—
MAX4286EUT-T	-40°C to +85°C	6 SOT23-6	AABR
MAX4286ESA	-40°C to +85°C	8 SO	—
MAX4287EUA	-40°C to +85°C	8 $\mu$ MAX	—
MAX4287ESA	-40°C to +85°C	8 SO	—

Ordering Information continued at end of data sheet.

## Selector Guide

PART	OP AMPS PER PKG	MIN GAIN	-3dB BANDWIDTH (AT MIN GAIN)	HIGH-SPEED DISABLE	PIN-PACKAGE
MAX4285	1	1	250MHz	Yes	6-pin SOT23, 8-pin SO
MAX4286	1	5	150MHz	Yes	6-pin SOT23, 8-pin SO
MAX4287	2	1	250MHz	No	8-pin $\mu$ MAX/SO
MAX4288	2	1	250MHz	Yes	10-pin $\mu$ MAX/14-pin SO
MAX4387	2	5	150MHz	No	8-pin $\mu$ MAX/SO
MAX4388	2	5	150MHz	Yes	10-pin $\mu$ MAX, 14-pin SO



# +3V/+5V, 250MHz, SOT23 ADC Buffer Amplifiers with High-Speed Disable

## ABSOLUTE MAXIMUM RATINGS

Supply Voltage ( $V_{CC} - V_{EE}$ )	-0.3V to +7.5V	8-Pin $\mu$ MAX (derate 4.1mW/°C above +70°C)	330mW
Input Voltage Range (IN+, IN-)	( $V_{EE} - 0.3V$ ) to ( $V_{CC} + 0.3V$ )	10-Pin $\mu$ MAX (derate 5.6mW/°C above +70°C)	444mW
Differential Input Voltage	-0.3V to +7.5V	8-Pin SO (derate 5.88mW/°C above +70°C)	471mW
Voltage at $\overline{DISABLE}$	( $V_{EE} - 0.3V$ ) to ( $V_{CC} + 0.3V$ )	14-Pin SO (derate 8.3mW/°C above +70°C)	667mW
Current into IN+, IN-, $\overline{DISABLE}$	$\pm 20mA$	Operating Temperature Range	-40°C to +85°C
Output Short-Circuit Duration	Indefinite	Junction Temperature	+150°C
Continuous Power Dissipation ( $T_A = +70^\circ C$ )		Storage Temperature Range	-65°C to +150°C
6-Pin SOT23 (derate 7.1mW/°C above +70°C)	571mW	Lead Temperature (soldering, 10s)	+300°C

Stresses beyond those listed under "Absolute Maximum Ratings" may cause permanent damage to the device. These are stress ratings only, and functional operation of the device at these or any other conditions beyond those indicated in the operational sections of the specifications is not implied. Exposure to absolute maximum rating conditions for extended periods may affect device reliability.

## DC ELECTRICAL CHARACTERISTICS

( $V_{CC} = +3V$ ,  $V_{EE} = 0$ ,  $\overline{DISABLE} = 3V$ ,  $R_L = \infty$ ,  $V_{CM} = 1V$ , and  $T_A = T_{MIN}$  to  $T_{MAX}$ , unless otherwise noted. Typical values are at  $T_A = +25^\circ C$ .) (Note 1)

PARAMETER	SYMBOL	CONDITIONS	MIN	TYP	MAX	UNITS
Operating Supply Voltage Range		Guaranteed by PSRR test	2.85		6.5	V
Input Common-Mode Voltage Range	$V_{CM}$	Guaranteed by CMRR test	$V_{EE}$		$V_{CC} - 1.25$	V
Input Offset Voltage	$V_{OS}$	MAX4_87EU_/MAX4_88EU_/MAX4_8_ES_		$\pm 0.1$	$\pm 8$	mV
		MAX4285EUT-T/MAX4286EUT-T		$\pm 1.5$	$\pm 12$	
Input Offset-Voltage Temperature Coefficient	$TC_{VOS}$			26		$\mu V/^\circ C$
Input Offset-Voltage Matching	$\Delta V_{OS}$	MAX4287/88 and MAX4387/88		$\pm 0.2$		mV
Input Bias Current	$I_B$			13	35	$\mu A$
Input Offset Current	$I_{OS}$			0.2	8	$\mu A$
Input Resistance	$R_{IN}$	Differential ( $-10mV \leq V_{IN} \leq +10mV$ )		38		k $\Omega$
		Common mode ( $V_{EE} \leq V_{CM} \leq V_{CC} - 1.25V$ )		600		
Common-Mode Rejection Ratio	CMRR	$V_{EE} \leq V_{CM} \leq V_{CC} - 1.25V$	MAX4_87EU_/MAX4_88EU_/MAX4_8_ES_	50	73	dB
			MAX4285EUT-T/MAX4286EUT-T	45	68	
Open-Loop Gain	$A_{VOL}$	$V_{EE} + 0.4V \leq V_{OUT} \leq V_{CC} - 0.4V$	$R_L = 2k\Omega$	75	94	dB
			$R_L = 300\Omega$	65	94	
			$R_L = 100\Omega$	60	85	

# +3V/+5V, 250MHz, SOT23 ADC Buffer Amplifiers with High-Speed Disable

## DC ELECTRICAL CHARACTERISTICS (continued)

( $V_{CC} = +3V$ ,  $V_{EE} = 0$ ,  $\overline{DISABLE}_- = 3V$ ,  $R_L = \infty$ ,  $V_{CM} = 1V$ , and  $T_A = T_{MIN}$  to  $T_{MAX}$ , unless otherwise noted. Typical values are at  $T_A = +25^\circ C$ .) (Note 1)

PARAMETER	SYMBOL	CONDITIONS		MIN	TYP	MAX	UNITS
Output Current Drive	$I_{OUT}$	$R_L = 20\Omega$ to $V_{EE}$			77		mA
		$R_L = 20\Omega$ to $V_{CC}$			106		
Power-Supply Rejection Ratio	PSRR	$V_{CC} = 2.85V$ to $6.5V$		40	50		dB
Disabled Output Leakage Current	$I_{LEAK}$	$\overline{DISABLE}_- = V_{EE}$ , $V_{EE} \leq V_{OUT} \leq V_{CC}$			700		nA
$\overline{DISABLE}_-$ Logic Low Threshold	$V_{IL}$					$V_{CC} - 2$	V
$\overline{DISABLE}_-$ Logic High Threshold	$V_{IH}$			$V_{CC} - 1$			V
$\overline{DISABLE}_-$ Logic Input Low Current	$I_{IL}$	$\overline{DISABLE}_- = V_{EE}$			$\pm 3$	$\pm 22$	$\mu A$
$\overline{DISABLE}_-$ Logic Input High Current	$I_{IH}$	$\overline{DISABLE}_- = V_{CC}$			$\pm 3$	$\pm 22$	$\mu A$
Quiescent Supply Current (per Amplifier)	$I_{SY}$	$V_{CC} = 3V$	Normal mode		20	24	mA
			Disabled mode, $\overline{DISABLE}_- = V_{EE}$		1	3	
		$V_{CC} = 5V$	Normal mode		23	28	
			Disabled mode, $\overline{DISABLE}_- = V_{EE}$		1	3	

MAX4285-MAX4288/MAX4387/MAX4388

# +3V/+5V, 250MHz, SOT23 ADC Buffer Amplifiers with High-Speed Disable

## AC ELECTRICAL CHARACTERISTICS

( $V_{CC} = +3V$ ,  $V_{EE} = 0$ ,  $\overline{DISABLE} = 3V$ ,  $R_L = 300\Omega$  to  $V_{CC}/2$ ,  $V_{CM} = 1V$ ,  $A_{VCL} = +1V/V$  for MAX4285/MAX4287/MAX4288,  $A_{VCL} = +5V/V$  for MAX4286 and MAX4387/MAX4388,  $T_A = +25^\circ C$ , unless otherwise noted.)

PARAMETER	SYMBOL	CONDITIONS		MIN	TYP	MAX	UNITS
Small-Signal -3dB Bandwidth	BW <sub>SS</sub>	V <sub>OUT</sub> = 100mVp-p	MAX4285/87/88	250		150	MHz
			MAX4286 and MAX4387/88				
Large-Signal -3dB Bandwidth	BW <sub>LS</sub>	V <sub>OUT</sub> = 1Vp-p		200			MHz
Bandwidth for 0.1dB Flatness	BW <sub>0.1dB</sub>	V <sub>OUT</sub> = 100mVp-p	MAX4285/87/88	100		50	MHz
			MAX4286 and MAX4387/88				
Slew Rate	SR	V <sub>OUT</sub> = 1V step, 10% to 90%		350			V/ $\mu$ s
Rise Time	t <sub>R</sub>	V <sub>OUT</sub> = 1V step, 10% to 90%		2.2			ns
Fall Time	t <sub>F</sub>	V <sub>OUT</sub> = 1V step, 90% to 10%		2.8			ns
Settling Time (0.1%)	t <sub>S</sub> 0.1%	V <sub>OUT</sub> = 1V step	MAX4285/87/88	6		14	ns
			MAX4286 and MAX4387/88				
Overload Recovery Time		10% overdrive		25			ns
Spurious-Free Dynamic Range	SFDR	V <sub>OUT</sub> = 0.5Vp-p	f <sub>C</sub> = 100kHz	88		87	dBc
			f <sub>C</sub> = 1MHz	88			
			f <sub>C</sub> = 5MHz	87			
			f <sub>C</sub> = 10MHz	79			
			f <sub>C</sub> = 20MHz	70			
			f <sub>C</sub> = 60MHz	50			
Two-Tone Third-Order Intercept	IP <sup>3</sup>	f <sub>C</sub> = 20MHz		34			dBm
Input Noise Voltage Density	e <sub>n</sub>	f = 1MHz		10			nV/ $\sqrt{Hz}$
Input Noise Current Density	i <sub>n</sub>	f = 1MHz		2.1			pA/ $\sqrt{Hz}$
Input Capacitance	C <sub>IN</sub>			2			pF
Output Impedance	Z <sub>OUT</sub>	f = 10MHz		0.5			$\Omega$
Enable Time	t <sub>ON</sub>	V <sub>OUT</sub> = 1V, to within 0.1%		40		50	ns
Disable Time	t <sub>OFF</sub>	V <sub>OUT</sub> = 1V, to within 0.1%					
Crosstalk	X <sub>TALK</sub>	MAX4287/88 and MAX4387/88, f = 10MHz, V <sub>OUT</sub> = 1Vp-p		85			dBc

# +3V/+5V, 250MHz, SOT23 ADC Buffer Amplifiers with High-Speed Disable

**MAX4285-MAX4288/MAX4387/MAX4388**

## AC ELECTRICAL CHARACTERISTICS (continued)

(V<sub>CC</sub> = +5V, V<sub>EE</sub> = 0,  $\overline{\text{DISABLE}} = 5V$ , R<sub>L</sub> = 300Ω to V<sub>CC</sub>/2, V<sub>CM</sub> = 2.5V, A<sub>VCL</sub> = +1V/V for MAX4285/MAX4287/MAX4288, A<sub>VCL</sub> = +5V/V for MAX4286 and MAX4387/MAX4388, T<sub>A</sub> = +25°C, unless otherwise noted.)

PARAMETER	SYMBOL	CONDITIONS		MIN	TYP	MAX	UNITS
Small-Signal -3dB Bandwidth	BW <sub>SS</sub>	V <sub>OUT</sub> = 100mVp-p	MAX4285/87/88	220		MHz	
			MAX4286 and MAX4387/88	130			
Large-Signal -3dB Bandwidth	BW <sub>LS</sub>	V <sub>OUT</sub> = 1Vp-p		195		MHz	
Bandwidth for 0.1dB Flatness	BW <sub>0.1dB</sub>	V <sub>OUT</sub> = 100mVp-p	MAX4285/87/88	75		MHz	
			MAX4286 and MAX4387/88	40			
Slew Rate	SR	V <sub>OUT</sub> = 2V step, 10% to 90%		385		V/μs	
Rise Time	t <sub>R</sub>	V <sub>OUT</sub> = 2V step, 10% to 90%		4.2		ns	
Fall Time	t <sub>F</sub>	V <sub>OUT</sub> = 2V step, 90% to 10%		2.9		ns	
Settling Time (0.1%)	t <sub>S 0.1%</sub>	V <sub>OUT</sub> = 2V step	MAX4285/87/88	8		ns	
			MAX4286 and MAX4387/88	10			
Spurious-Free Dynamic Range	SFDR	V <sub>OUT</sub> = 1Vp-p	f <sub>C</sub> = 100kHz	86		dBc	
			f <sub>C</sub> = 1MHz	86			
			f <sub>C</sub> = 5MHz	86			
			f <sub>C</sub> = 10MHz	77			
			f <sub>C</sub> = 20MHz	64			
			f <sub>C</sub> = 60MHz	45			
Two-Tone Third-Order Intercept	IP3	f <sub>C</sub> = 20MHz		40		dBm	
Input Noise Voltage Density	e <sub>n</sub>	f = 1MHz		6.5		nV/√Hz	
Input Noise Current Density	i <sub>n</sub>	f = 1MHz		1.9		pA/√Hz	
Input Capacitance	C <sub>IN</sub>			2		pF	
Output Impedance	Z <sub>OUT</sub>	f = 10MHz		0.5		Ω	
Enable Time	t <sub>ON</sub>	V <sub>OUT</sub> = 1V, to within 0.1%		40		ns	
Disable Time	t <sub>OFF</sub>	V <sub>OUT</sub> = 1V, to within 0.1%		35			
Crosstalk	X <sub>TALK</sub>	MAX4287/88 and MAX4387/88, f = 10MHz, V <sub>OUT</sub> = 2Vp-p		85		dBc	

**Note 1:** The MAX428\_EUT (SOT23) are 100% production tested at T<sub>A</sub> = +25°C. Specifications over temperature limits are guaranteed by design.

# +3V/+5V, 250MHz, SOT23 ADC Buffer Amplifiers with High-Speed Disable

## Typical Operating Characteristics

( $V_{CC} = +3V$ ,  $V_{EE} = 0$ ,  $\overline{DISABLE} \geq 2V$ ,  $R_L = 300\Omega$  to  $V_{CC}/2$ ,  $V_{CM} = +1.0V$ ,  $T_A = +25^\circ C$ , unless otherwise noted.)

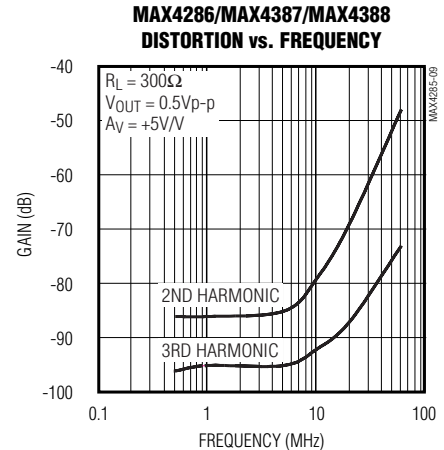
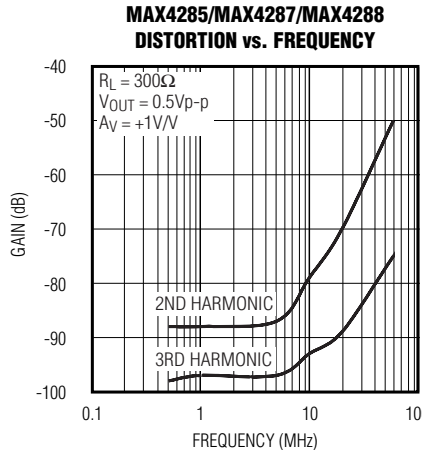
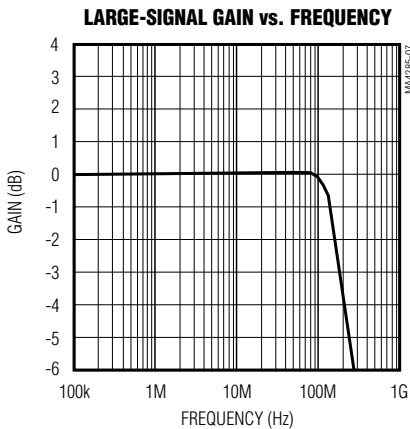
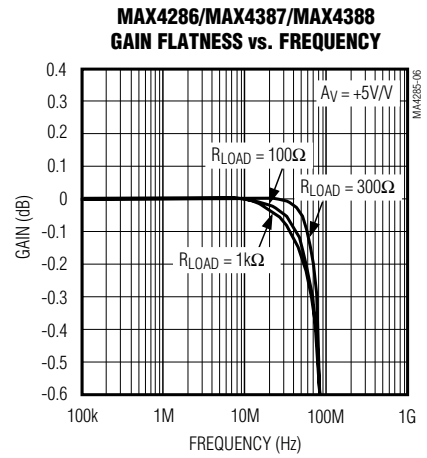
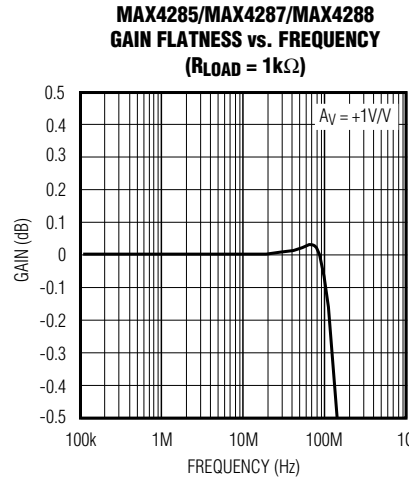
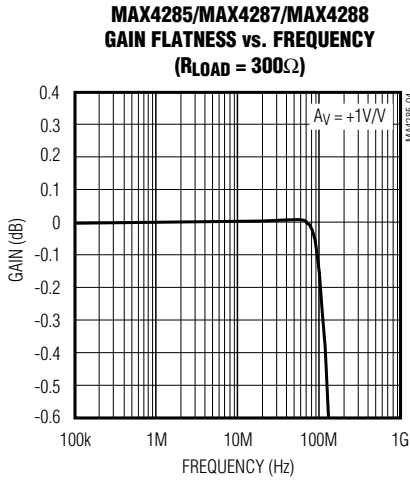
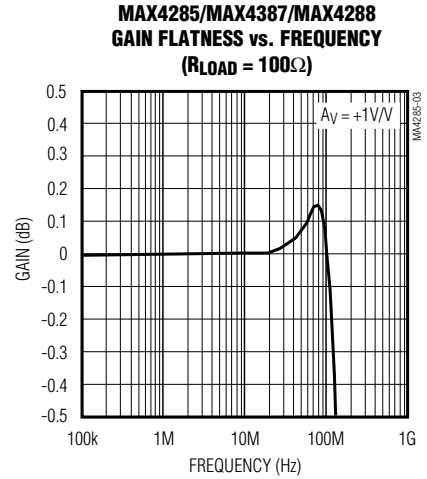
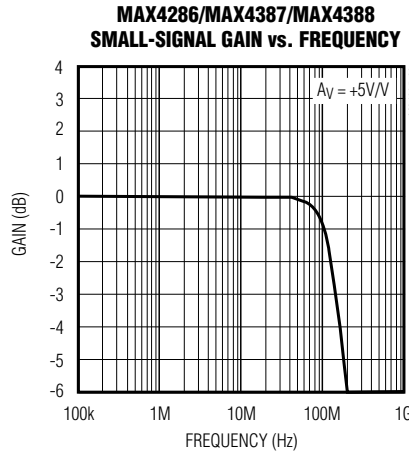
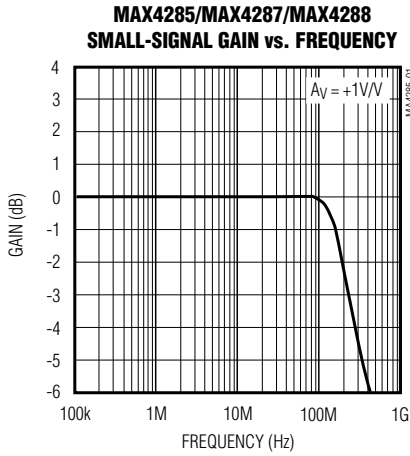

# +3V/+5V, 250MHz, SOT23 ADC Buffer Amplifiers with High-Speed Disable

## Typical Operating Characteristics (continued)

( $V_{CC} = +3V$ ,  $V_{EE} = 0$ ,  $\overline{DISABLE} \geq 2V$ ,  $R_L = 300\Omega$  to  $V_{CC}/2$ ,  $V_{CM} = +1.0V$ ,  $T_A = +25^\circ C$ , unless otherwise noted.)

MAX4285-MAX4288/MAX4387/MAX4388

**MAX4285/MAX4287/MAX4288  
DISTORTION vs. LOAD**

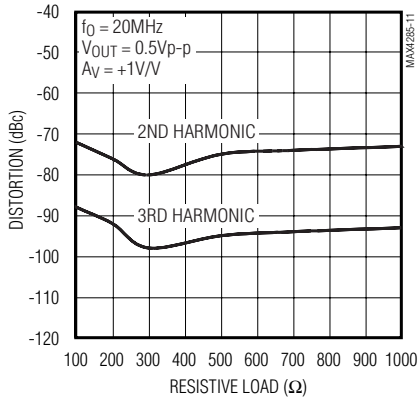

**MAX4286/MAX4387/MAX4388  
DISTORTION vs. LOAD**

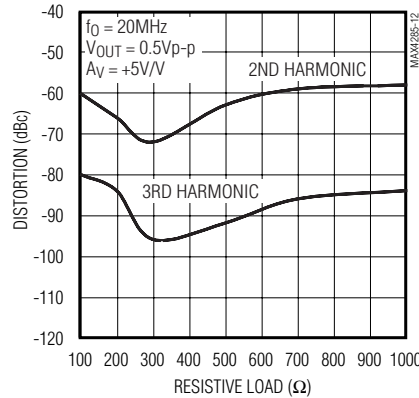

**MAX4285/MAX4287/MAX4288  
DISTORTION vs. SWING**

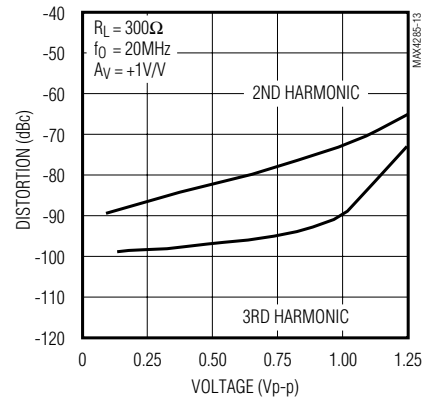

**MAX4286/MAX4387/MAX4388  
DISTORTION vs. SWING**

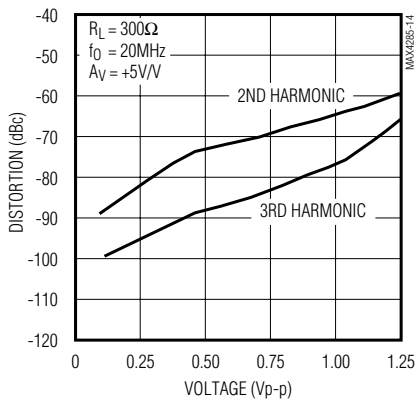

**MAX4285/MAX4286/MAX4288/MAX4388  
OFF-ISOLATION vs. FREQUENCY**

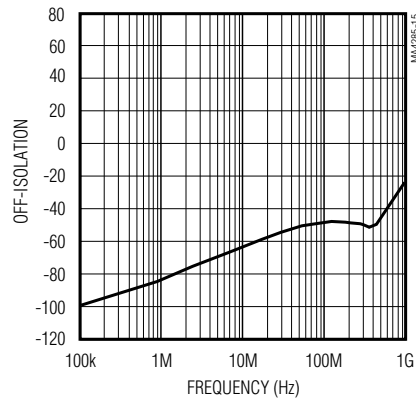

**MAX4287/MAX4288/MAX4387/MAX4388  
CROSSTALK vs. FREQUENCY**

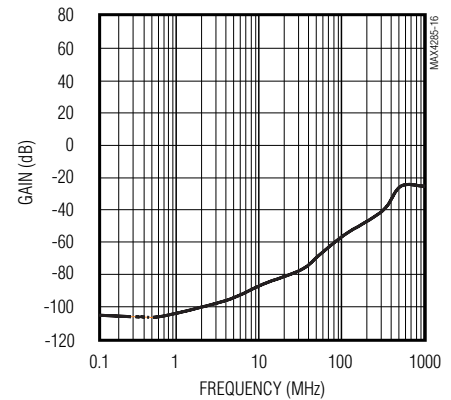

**MAX4285/MAX4287/MAX4288  
LARGE-SIGNAL PULSE RESPONSE  
( $A_V = +1\text{V/V}$ )**

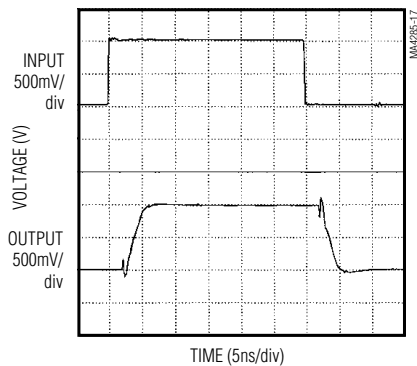

**MAX4286/MAX4387/MAX4388  
LARGE-SIGNAL PULSE RESPONSE  
( $A_V = +5\text{V/V}$ )**

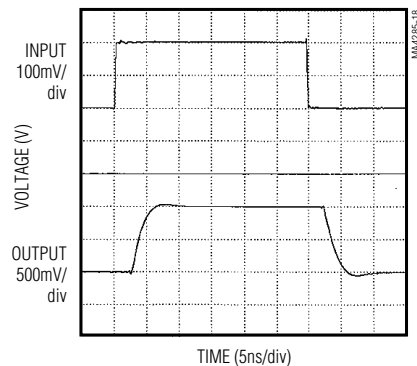

# +3V/+5V, 250MHz, SOT23 ADC Buffer Amplifiers with High-Speed Disable

## Typical Operating Characteristics (continued)

( $V_{CC} = +3V$ ,  $V_{EE} = 0$ ,  $\overline{DISABLE} \geq 2V$ ,  $R_L = 300\Omega$  to  $V_{CC}/2$ ,  $V_{CM} = +1.0V$ ,  $T_A = +25^\circ C$ , unless otherwise noted.)

**MAX4285/MAX4287/MAX4288  
SMALL-SIGNAL PULSE RESPONSE  
( $A_V = +1V/V$ )**

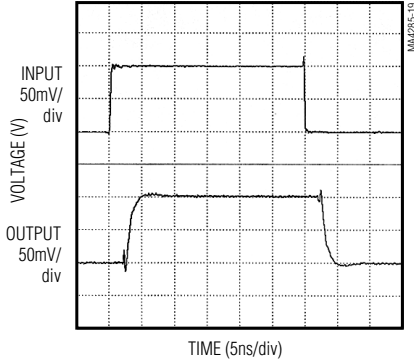

**MAX4286/MAX4387/MAX4388  
SMALL-SIGNAL PULSE RESPONSE  
( $A_V = +5V/V$ )**

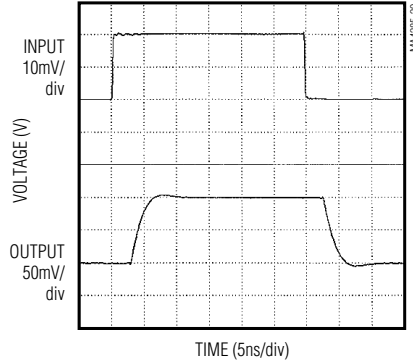

**MAX4285/MAX4287/MAX4288  
SMALL-SIGNAL PULSE RESPONSE  
( $C_{LOAD} = 22pF$ ,  $A_V = +1V/V$ )**

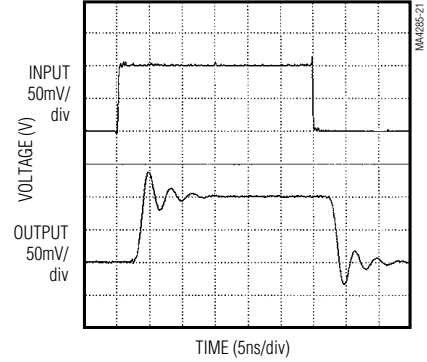

**MAX4286/MAX4387/MAX4388  
SMALL-SIGNAL PULSE RESPONSE  
( $C_{LOAD} = 47pF$ ,  $A_V = +5V/V$ )**

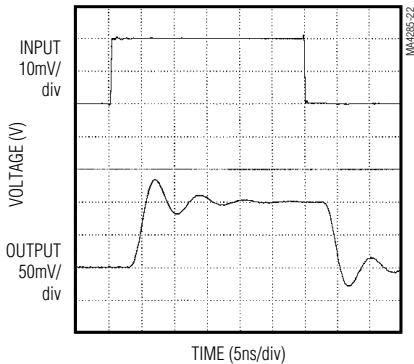

**ISOLATION RESISTANCE  
vs. LOAD CAPACITANCE**

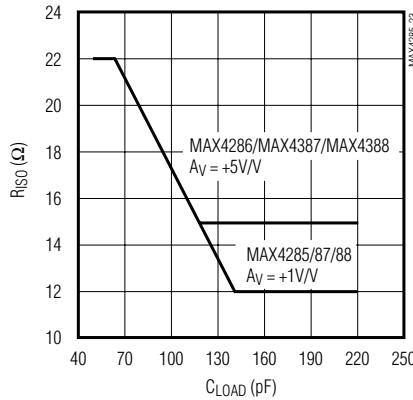

**GROUP DELAY vs. FREQUENCY**

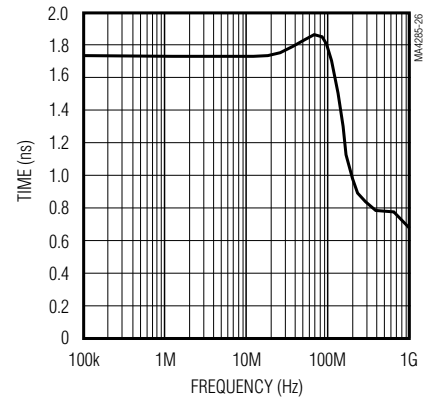

**POWER-SUPPLY REJECTION RATIO  
vs. FREQUENCY**

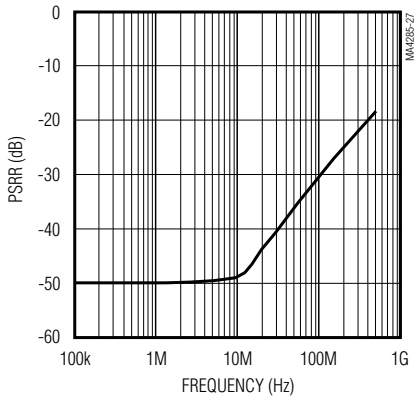

**COMMON-MODE REJECTION  
vs. FREQUENCY**

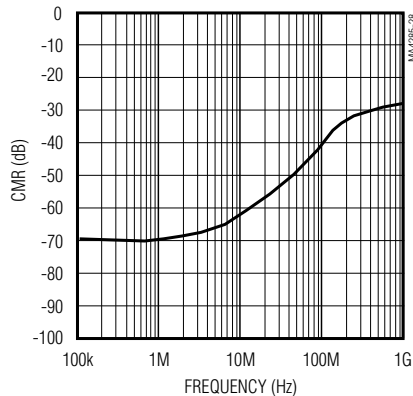

**OUTPUT IMPEDANCE vs. FREQUENCY**

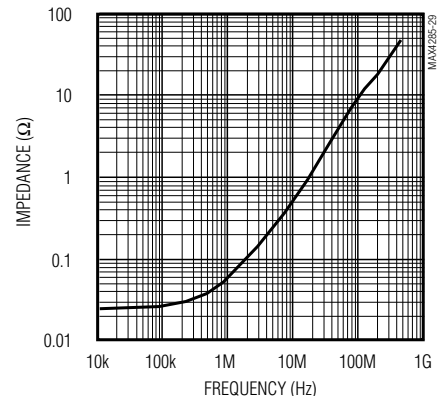

# +3V/+5V, 250MHz, SOT23 ADC Buffer Amplifiers with High-Speed Disable

## Typical Operating Characteristics (continued)

( $V_{CC} = +3V$ ,  $V_{EE} = 0$ ,  $\overline{DISABLE}_\geq 2V$ ,  $R_L = 300\Omega$  to  $V_{CC}/2$ ,  $V_{CM} = +1.0V$ ,  $T_A = +25^\circ C$ , unless otherwise noted.)

MAX4285-MAX4288/MAX4387/MAX4388

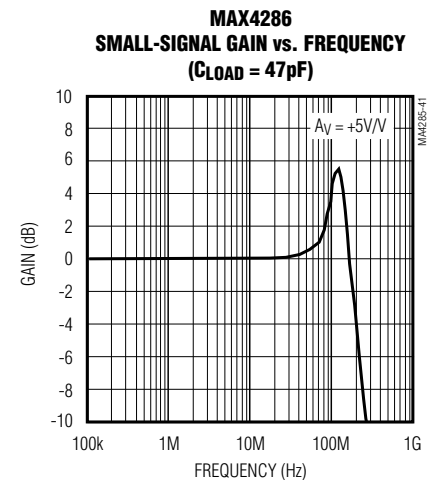
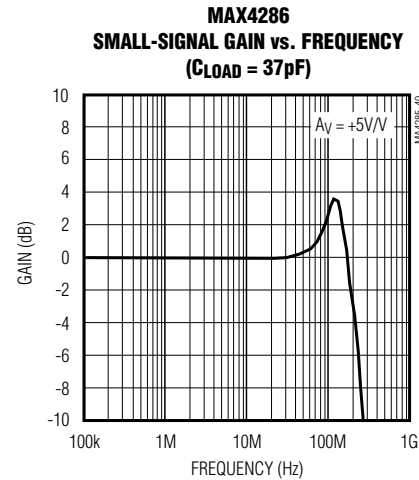
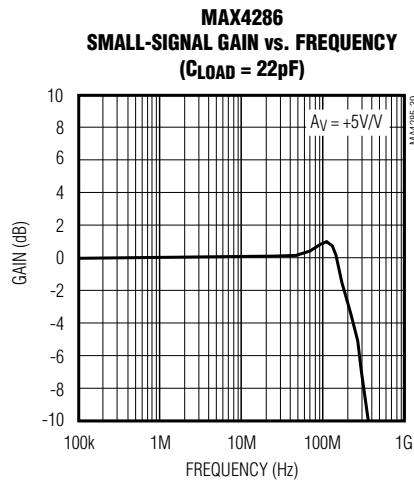
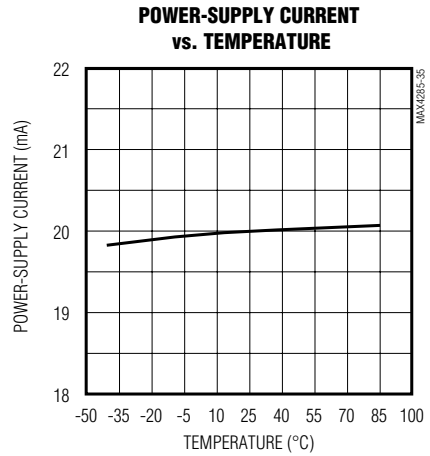
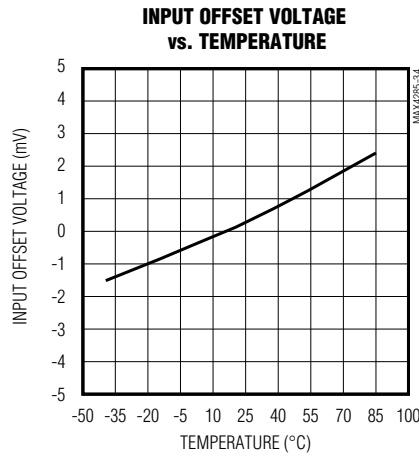
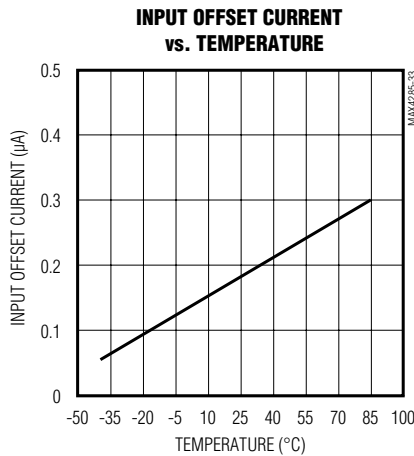
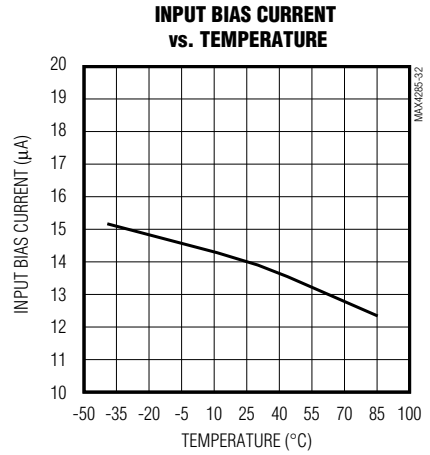
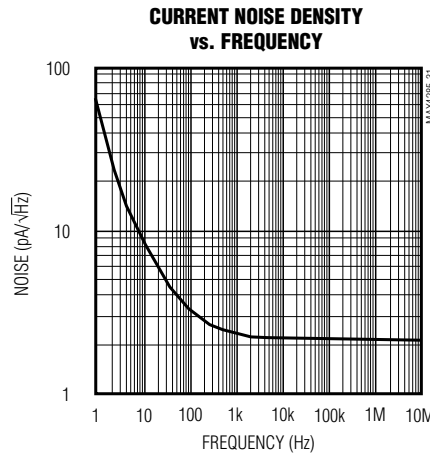
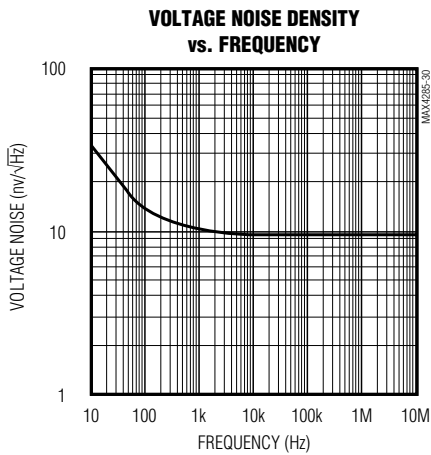

# +3V/+5V, 250MHz, SOT23 ADC Buffer Amplifiers with High-Speed Disable

## Typical Operating Characteristics (continued)

( $V_{CC} = +3V$ ,  $V_{EE} = 0$ ,  $\overline{DISABLE} \geq 2V$ ,  $R_L = 300\Omega$  to  $V_{CC}/2$ ,  $V_{CM} = +1.0V$ ,  $T_A = +25^\circ C$ , unless otherwise noted.)

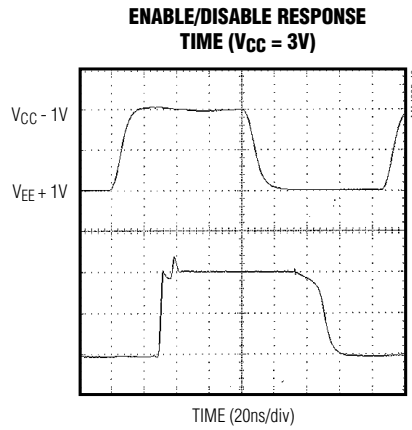
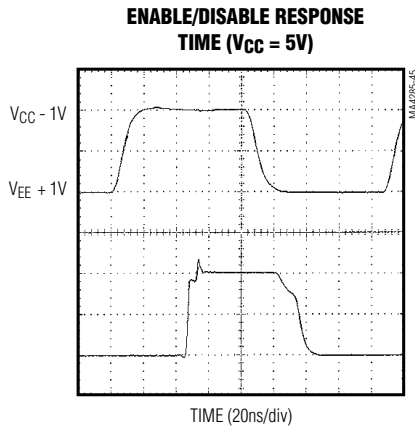
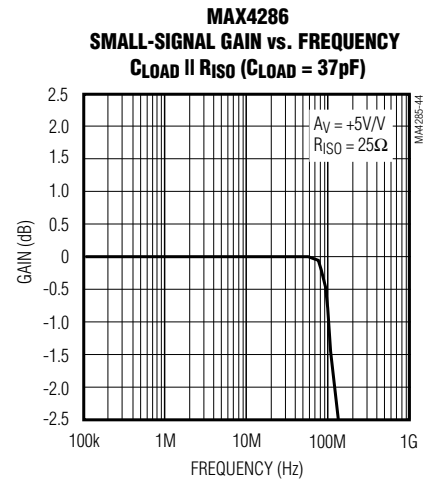
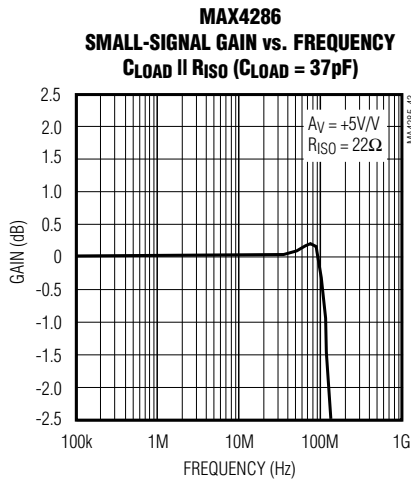
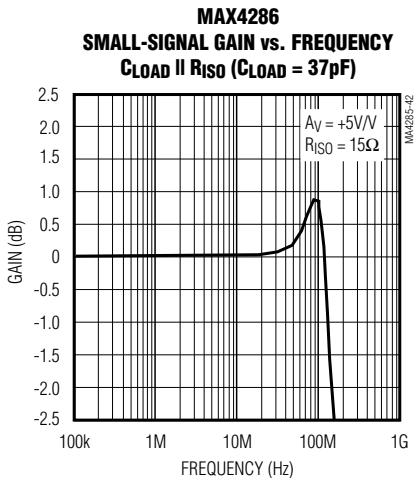

# +3V/+5V, 250MHz, SOT23 ADC Buffer Amplifiers with High-Speed Disable

## Pin Description

PIN					NAME	FUNCTION
MAX4285 MAX4286		MAX4287 MAX4387	MAX4288 MAX4388			
6-PIN SOT23-6	8-PIN SO	8-PIN μMAX/SO	10-PIN μMAX	14-PIN SO		
—	1, 5	—	—	5, 7, 8, 10	N.C.	Not Internally Connected. Connect to ground or leave unconnected.
1	6	—	—	—	OUT	Amplifier Output
2	4	4	4	4	V <sub>EE</sub>	Negative Power Supply, or Ground in Single-Supply Operation
3	3	—	—	—	IN+	Noninverting Input
4	2	—	—	—	IN-	Inverting Input
5	8	—	—	—	$\overline{\text{DISABLE}}$	Disable (active low)
—	—	—	5	6	$\overline{\text{DISABLEA}}$	Disable Amplifier A (active low)
—	—	—	6	9	$\overline{\text{DISABLEB}}$	Disable Amplifier B (active low)
6	7	8	10	14	V <sub>CC</sub>	Positive Power Supply
—	—	1	1	1	OUTA	Amplifier A Output
—	—	2	2	2	INA-	Amplifier A Inverting Input
—	—	3	3	3	INA+	Amplifier A Noninverting Input
—	—	5	7	11	INB+	Amplifier B Noninverting Input
—	—	6	8	12	INB-	Amplifier B Inverting Input
—	—	7	9	13	OUTB	Amplifier B Output

### Detailed Description

The MAX4285–MAX4288 and MAX4387/MAX4388 are voltage-feedback op amps, intended for use as ADC input buffers. They operate from a single +2.85V to +6.5V supply or dual ±1.425V to ±3.25V supplies. Their high output drive, wide bandwidth, fast settling, low noise, and low distortion make them ideal for the brutal task of meeting the dynamic input drive requirements of high-speed ADCs or other demanding applications.

The MAX4285/MAX4286/MAX4288 and MAX4388 have a high-speed disable mode that places the outputs in a high-impedance state and lowers operating supply current to 1mA. The enable time is typically 40ns, and the disable time is typically 50ns. The MAX4285/MAX4286 have a single enable pin ( $\overline{\text{DISABLE}}$ ), and the MAX4288/

MAX4388 have dual disable pins ( $\overline{\text{DISABLEA}}$ ,  $\overline{\text{DISABLEB}}$ ).

The MAX4285/MAX4287/MAX4288 are internally compensated for unity-gain stability. The MAX4286/MAX4387/MAX4388 are compensated for gains of +5V/V or greater.

### Applications Information

#### Inverting and Noninverting Configurations

Select the gain-setting feedback (R<sub>F</sub>) and input (R<sub>G</sub>) resistor values considering the following criteria: large resistor values increase voltage noise and interact with the amplifier's input and PC board capacitance to effect system bandwidth. This generates undesirable poles and zeros that decrease bandwidth or cause oscillations.

MAX4285–MAX4288/MAX4387/MAX4388

## +3V/+5V, 250MHz, SOT23 ADC Buffer Amplifiers with High-Speed Disable

For example, a noninverting gain-of-two configuration ( $R_F = R_G$ ) using  $1k\Omega$  resistors, combined with  $2pF$  typical amplifier input capacitance, generates a pole at  $159MHz$ . Since this pole is within the amplifier bandwidth, it jeopardizes stability. Reducing these  $1k\Omega$  resistors to  $100\Omega$  extends the pole frequency to  $1.59GHz$ , but affects output swing by adding  $200\Omega$  in parallel with the amplifier's load resistor. The typical value for  $R_F$  is  $300\Omega$ .

### Layout and Power-Supply Bypassing

These amplifiers operate from a single  $+2.85V$  to  $+6.5V$  power supply or from  $\pm 1.425V$  to  $\pm 3.25V$  dual supplies. For single-supply operation, bypass  $V_{CC}$  to ground with a  $0.1nF$  capacitor as close to the pin as possible, with a  $0.1\mu F$  capacitor in parallel. If operating with dual supplies, bypass each supply with capacitors to ground.

Observe the following guidelines:

- A solid ground plane is essential for good high-frequency behavior.
- Where possible, use multiple ground vias.
- Use a PC board with at least two layers. Avoid areas of unreferenced copper-clad.
- Keep signal traces as short and as straight as possible. Do not make sharp turns; round all trace corners.
- Use a constant-impedance board design if possible.

### High-Speed Disable

The MAX4285/MAX4286/MAX4288 and MAX4388 feature a disable ( $\overline{DISABLE}$ ) input that places the amplifier in a low-power, high-output-impedance state. When  $\overline{DISABLE}$  is asserted, the amplifier's output impedance is typically  $35k\Omega$ . This high output impedance, combined with the low  $2pF$  output capacitance, make these devices ideal for ADC input multiplexing applications or switch applications. Typical enable/disable times are  $40ns/50ns$ .

### Output Capacitive Loading and Stability

These op amps are optimized for AC performance. They are not designed to drive highly reactive loads, which decrease phase margin and may produce excessive ringing and oscillation. A small isolation resistor (usually  $20\Omega$  to  $30\Omega$ ) placed before the reactive load reduces possible ringing and oscillation (Figure 1). At higher capacitive loads, AC performance is dependent on the interaction of the load capacitance, the isolation resistor, and on-board layout.

### Output Drive Capability

The MAX4285-MAX4288 and MAX4387/MAX4388 have an output sink capability of  $106mA$  and a source capability of  $77mA$ . This high current ability allows them to drive low-impedance and dynamic-impedance ADC inputs. The linear output range of these devices is ( $V_{EE} + 0.4V$ ) to ( $V_{CC} - 0.4V$ ). Operation beyond this range is not recommended due to reduced gain and phase margin.

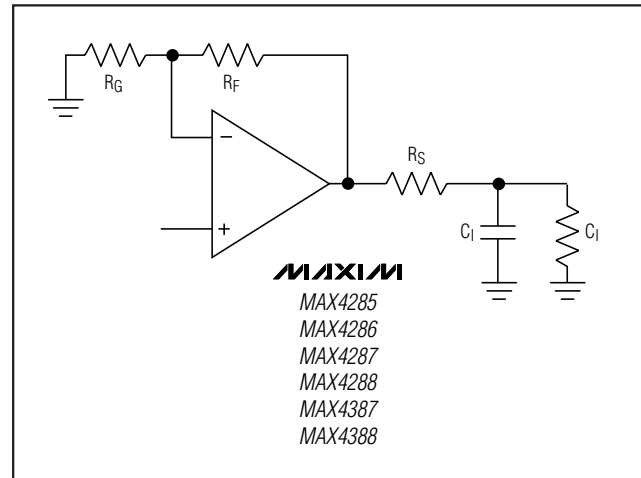

Figure 1. Using an Isolation Resistor ( $R_S$ ) for High Capacitive Loads

# +3V/+5V, 250MHz, SOT23 ADC Buffer Amplifiers with High-Speed Disable

## Ordering Information (continued)

PART	TEMP. RANGE	PIN-PACKAGE	SOT TOP MARK
MAX4288EUB	-40°C to +85°C	10 $\mu$ MAX	—
MAX4288ESD	-40°C to +85°C	14 SO	—
MAX4387EUA	-40°C to +85°C	8 $\mu$ MAX	—
MAX4387ESA	-40°C to +85°C	8 SO	—
MAX4388EUB	-40°C to +85°C	10 $\mu$ MAX	—
MAX4388ESD	-40°C to +85°C	14 SO	—

## Chip Information

TRANSISTOR COUNT: MAX4285/MAX4286 : 114  
 MA4287/MAX4288/  
 MAX4387/MAX4388 : 227

## Typical Operating Circuit

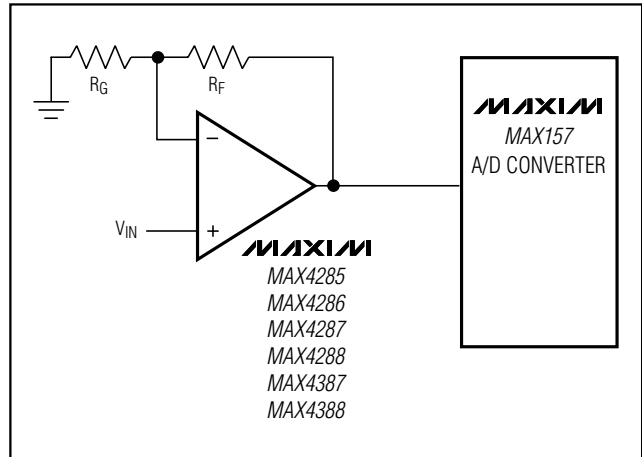

## Pin Configurations

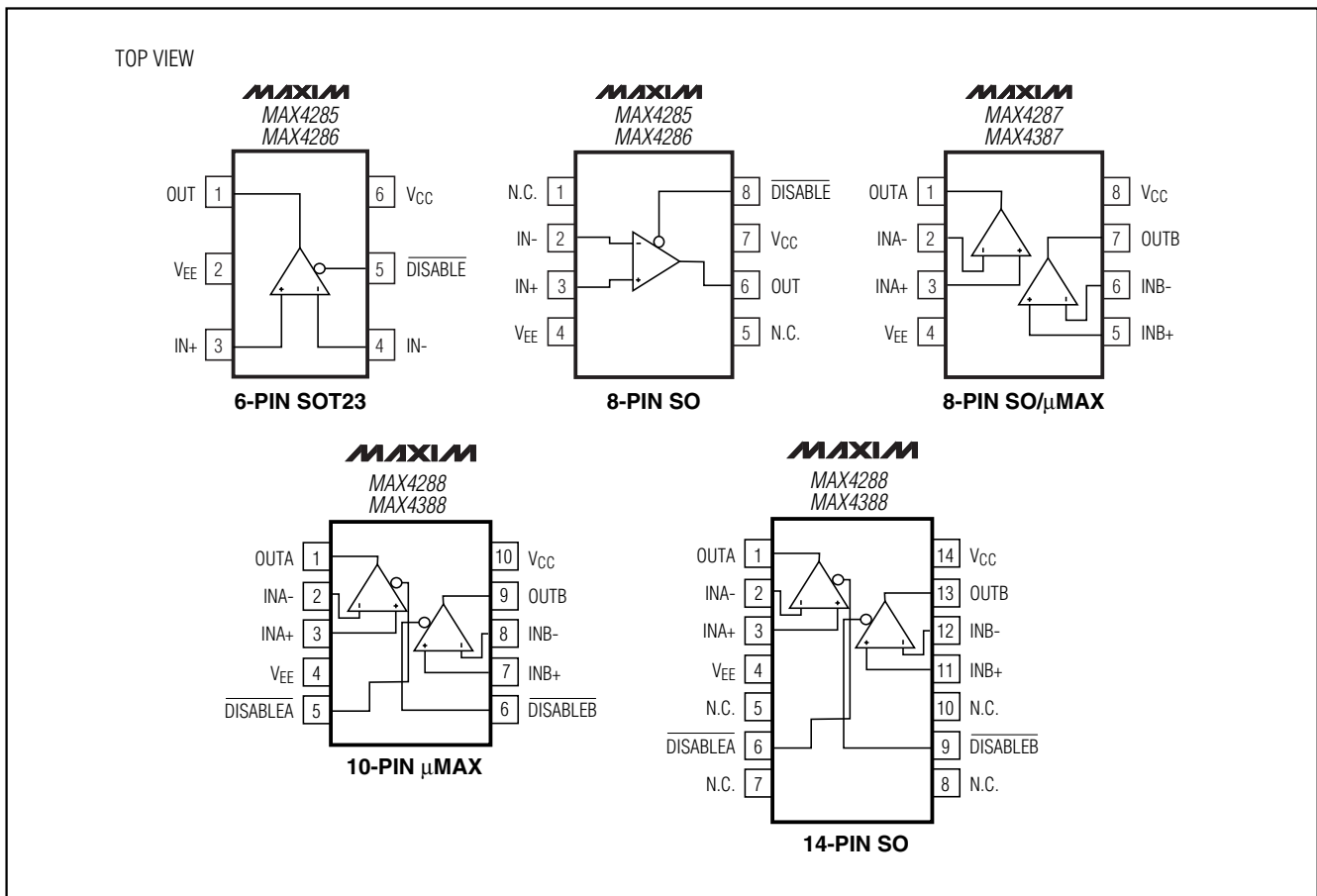

MAX4285-MAX4288/MAX4387/MAX4388

# +3V/+5V, 250MHz, SOT23 ADC Buffer Amplifiers with High-Speed Disable

## Package Information

SEE NOTE 5  
EXAMPLE  
TOP MARK

PIN 1  
I.D. DOT  
(SEE NOTE 6)

PIN #1

NOTE:

- ALL DIMENSIONS ARE IN MILLIMETERS.
- FOOT LENGTH MEASURED AT INTERCEPT POINT BETWEEN DATUM "A" & LEAD SURFACE.
- PACKAGE OUTLINE EXCLUSIVE OF MOLD FLASH & METAL BURR.
- PACKAGE OUTLINE INCLUSIVE OF SOLDER PLATING.
- PIN 1 IS LOWER LEFT PIN WHEN READING TOP MARK FROM LEFT TO RIGHT. (SEE EXAMPLE TOP MARK)
- PIN 1 I.D. DOT IS 0.3 MM Ø MIN. LOCATED ABOVE PIN 1.

SYMBOL	MIN	MAX
A	0.90	1.45
A1	0.00	0.15
A2	0.90	1.30
b	0.35	0.50
c	0.08	0.20
D	2.80	3.00
E	2.60	3.00
E1	1.50	1.75
L	0.35	0.55
e		0.95 REF
α	0°	10°

6LSOT.EPS

**MAXIM**

PROPRIETARY INFORMATION  
TITLE:  
PACKAGE OUTLINE, SOT23, 6L

APPROVAL: \_\_\_\_\_ DOCUMENT CONTROL NO. 21-0058 REV. 1/1

TOP VIEW

BOTTOM VIEW

FRONT VIEW

SIDE VIEW

EXPOSED PAD (Note 5)

JEDEC

	INCHES		MILLIMETERS		JEDEC			
	MIN	MAX	MIN	MAX	INCHES	MILLIMETERS	MIN	MAX
A	0.037	0.043	0.94	1.10	---	0.043	---	1.10
A1	0.002	0.006	0.05	0.15	0.002	0.006	0.05	0.15
B	0.010	0.014	0.25	0.36	0.010	0.016	0.25	0.40
C	0.005	0.007	0.13	0.18	0.005	0.009	0.13	0.23
D	0.116	0.120	2.95	3.05	0.114	0.122	2.9	3.1
e	0.0256	BSC	0.65	BSC	0.0256	BSC	0.64	BSC
E	0.116	0.120	2.95	3.05	0.114	0.122	2.9	3.1
H	0.188	0.198	4.78	5.03	0.193	BSC	4.9	BSC
L	0.016	0.026	0.41	0.66	0.016	0.027	0.40	0.70
α	0°	6°	0°	6°	0°	6°	0°	6°
*X	0.087	0.099	2.210	2.515				
*Y	0.062	0.074	1.575	1.880				

\* EXPOSED PAD (Note 5)

NOTES:

- D & E DO NOT INCLUDE MOLD FLASH.
- MOLD FLASH OR PROTRUSIONS NOT TO EXCEED .15 MM (.006").
- CONTROLLING DIMENSION: MILLIMETERS.
- MEETS JEDEC MO-187.
- DIMENSIONS X & Y APPLY TO EXPOSED PAD (EP) VERSIONS ONLY. SEE INDIVIDUAL PRODUCT DATASHEET TO DETERMINE IF A PRODUCT USES EXPOSED PAD PACKAGE.
- EXPOSED PAD FLUSH WITH BOTTOM OF PACKAGE WITHIN .002".

**MAXIM**

PROPRIETARY INFORMATION  
TITLE:  
PACKAGE OUTLINE, 8L UMAX WITH EP OPTION

APPROVAL: \_\_\_\_\_ DOCUMENT CONTROL NO. 21-0036 REV. H 1/1

8LUMAXD.EPS

# +3V/+5V, 250MHz, SOT23 ADC Buffer Amplifiers with High-Speed Disable

## Package Information (continued)

MAX4285-MAX4288/MAX4387/MAX4388

10LUMAX.EPS

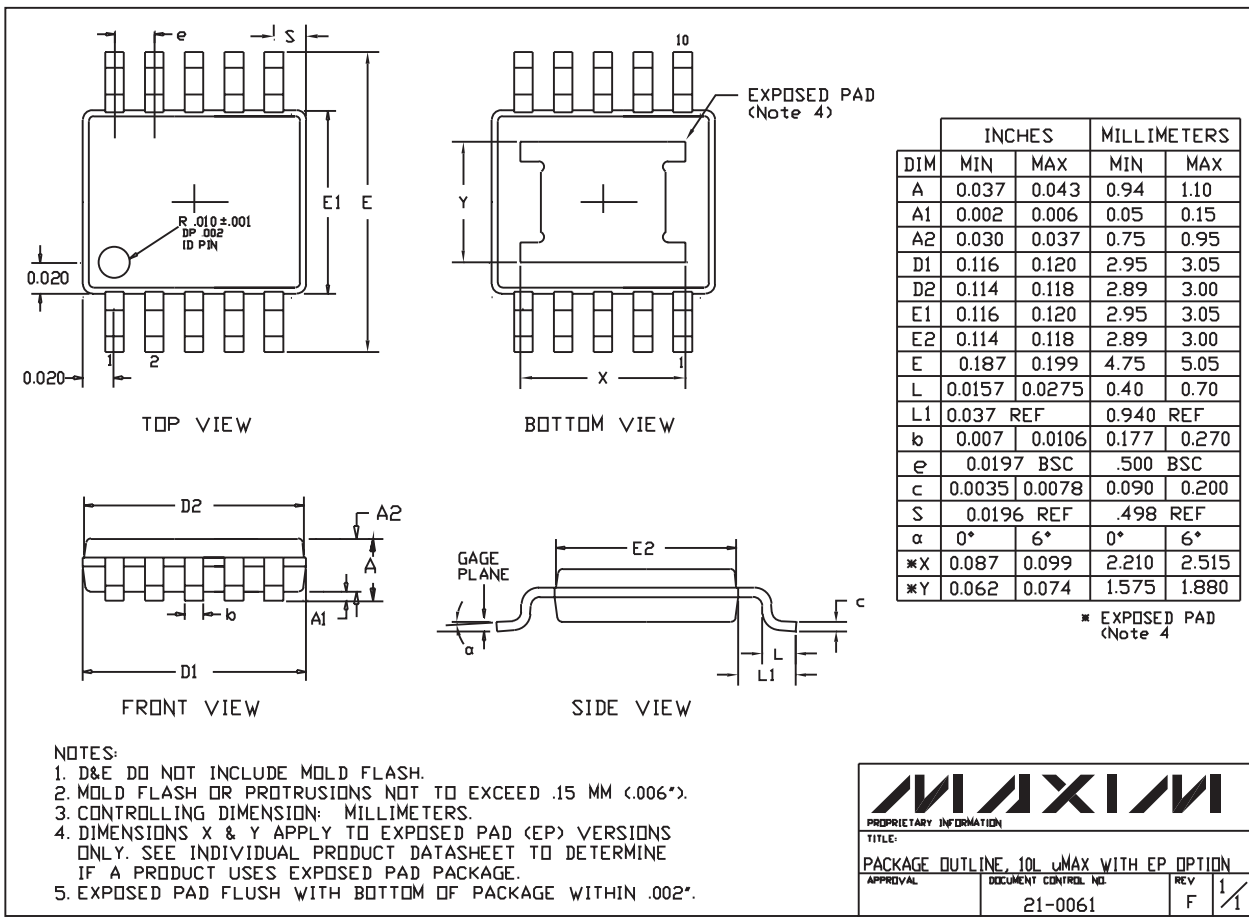

**MAXIM**

PROPRIETARY INFORMATION

TITLE: PACKAGE OUTLINE, 10L UMAX WITH EP OPTION

APPROVAL: [Signature] DOCUMENT CONTROL NO: 21-0061 REV: F 1/1

# +3V/+5V, 250MHz, SOT23 ADC Buffer Amplifiers with High-Speed Disable

## Package Information (continued)

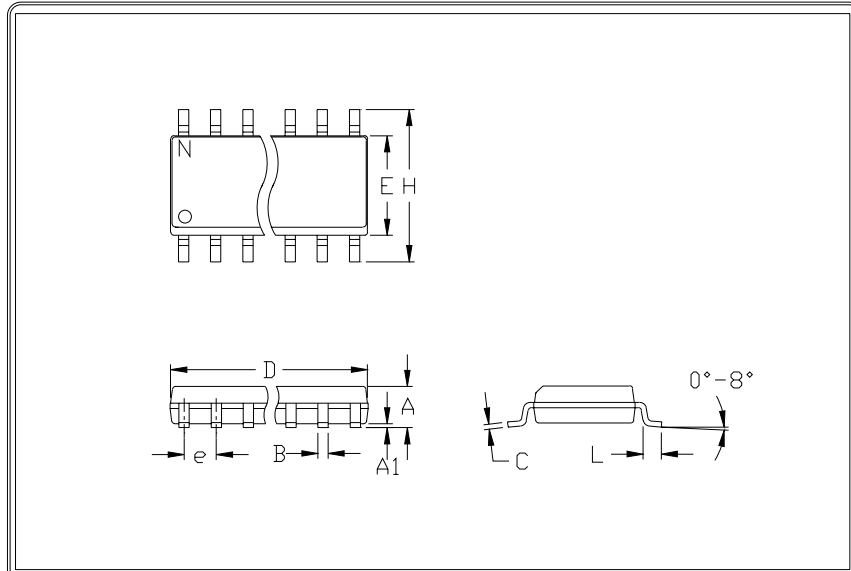

	INCHES		MILLIMETERS	
	MIN	MAX	MIN	MAX
A	0.053	0.069	1.35	1.75
A1	0.004	0.010	0.10	0.25
B	0.014	0.019	0.35	0.49
C	0.007	0.010	0.19	0.25
e	0.050		1.27	
E	0.150	0.157	3.80	4.00
H	0.228	0.244	5.80	6.20
h	0.010	0.020	0.25	0.50
L	0.016	0.050	0.40	1.27

	INCHES		MILLIMETERS		N	MS012
	MIN	MAX	MIN	MAX		
D	0.189	0.197	4.80	5.00	8	A
D	0.337	0.344	8.55	8.75	14	B
D	0.386	0.394	9.80	10.00	16	C

- NOTES:
1. D&E DO NOT INCLUDE MOLD FLASH
  2. MOLD FLASH OR PROTRUSIONS NOT TO EXCEED .15mm (.006")
  3. LEADS TO BE COPLANAR WITHIN .102mm (.004")
  4. CONTROLLING DIMENSION: MILLIMETER
  5. MEETS JEDEC MS012-XX AS SHOWN IN ABOVE TABLE
  6. N = NUMBER OF PINS

 120 SAN GABRIEL DR. SUNNYVALE CA 94086 FAX 408 737 7794 PROPRIETARY INFORMATION  
 PACKAGE FAMILY OUTLINE: SOT23 .150"  $\frac{1}{1}$  21-0041 A  
TITLE DOCUMENT CONTROL NUMBER REV

Maxim cannot assume responsibility for use of any circuitry other than circuitry entirely embodied in a Maxim product. No circuit patent licenses are implied. Maxim reserves the right to change the circuitry and specifications without notice at any time.

16 **Maxim Integrated Products, 120 San Gabriel Drive, Sunnyvale, CA 94086 408-737-7600**

## Looking for pricing, stock, or lifecycle information?

Click below to explore more details on WIN SOURCE:

- ⊖ [View MAX4387EUA+T on WIN SOURCE](#)
- ⊖ [Maxim Integrated Information](#)

## Optimize Your Supply Chain with WIN SOURCE Solutions

- ✓ Global Sourcing Solution
- ✓ Obsolete Management
- ✓ Cost Control Management
- ✓ Shortage Management
- ✓ Alternative Solution
- ✓ Excess Inventory Management