



**THE DATASHEET OF  
MSA-0636-TR1G**



# MSA-0636

## Cascadable Silicon Bipolar MMIC Amplifiers



### Data Sheet

#### Description

The MSA-0636 is a high performance silicon bipolar Monolithic Microwave Integrated Circuit (MMIC) housed in a cost effective, microstrip package. This MMIC is designed for use as a general purpose 50Ω gain block. Typical applications include narrow and broad band IF and RF amplifiers in commercial and industrial applications.

The MSA-series is fabricated using Avago's 10 GHz  $f_T$ , 25 GHz  $f_{MAX}$ , silicon bipolar MMIC process which uses nitride self-alignment, ion implantation, and gold metallization to achieve excellent performance, uniformity and reliability. The use of an external bias resistor for temperature and current stability also allows bias flexibility.

#### Features

- Cascadable 50Ω Gain Block
- Low Operating Voltage:  
3.5 V Typical  $V_d$
- 3 dB Bandwidth:  
DC to 0.9 GHz
- High Gain:  
19.0 dB Typical at 0.5 GHz
- Low Noise Figure:  
2.8 dB Typical at 0.5 GHz
- Cost Effective Ceramic Microstrip Package

#### 36 micro-X Package

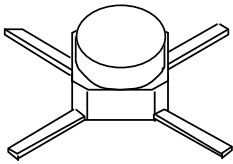

#### Typical Biasing Configuration

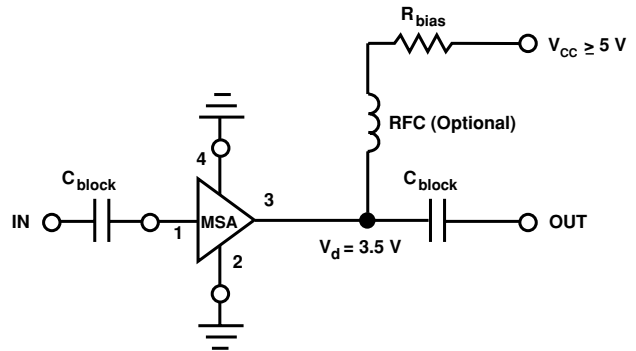

### MSA-0636 Absolute Maximum Ratings

Parameter	Absolute Maximum <sup>[1]</sup>
Device Current	50 mA
Power Dissipation <sup>[2,3]</sup>	200 mW
RF Input Power	+13 dBm
Junction Temperature	150°C
Storage Temperature <sup>[4]</sup>	-65 to 150°C

### Thermal Resistance<sup>[2,5]:</sup>

$$\theta_{jc} = 155^{\circ}\text{C}/\text{W}$$

#### Notes:

1. Permanent damage may occur if any of these limits are exceeded.
2.  $T_{\text{CASE}} = 25^{\circ}\text{C}$ .
3. Derate at  $6.5 \text{ mW}/^{\circ}\text{C}$  for  $T_{\text{C}} > 169^{\circ}\text{C}$ .
4. Storage above  $+150^{\circ}\text{C}$  may tarnish the leads of this package making it difficult to solder into a circuit.
5. The small spot size of this technique results in a higher, though more accurate determination of  $\theta_{jc}$  than do alternate methods.

### Electrical Specifications<sup>[1]</sup>, $T_{\text{A}} = 25^{\circ}\text{C}$

Symbol	Parameters and Test Conditions: $I_{\text{d}} = 16 \text{ mA}$ , $Z_{\text{O}} = 50 \Omega$	Units	Min.	Typ.	Max.
GP	Power Gain ( $ S_{21} ^2$ ) $f = 0.1 \text{ GHz}$	dB	19.0	20.5	22.0
$\Delta\text{GP}$	Gain Flatness $f = 0.1 \text{ to } 0.5 \text{ GHz}$	dB		$\pm 0.7$	$\pm 1.0$
$f_{3 \text{ dB}}$	3 dB Bandwidth	GHz		0.9	
VSWR	Input VSWR $f = 0.1 \text{ to } 1.5 \text{ GHz}$			1.4:1	
	Output VSWR $f = 0.1 \text{ to } 1.5 \text{ GHz}$			1.3:1	
NF	50 $\Omega$ Noise Figure $f = 0.5 \text{ GHz}$	dB		2.8	4.0
$P_{1 \text{ dB}}$	Output Power at 1 dB Gain Compression $f = 0.5 \text{ GHz}$	dBm		2.0	
$\text{IP}_3$	Third Order Intercept Point $f = 0.5 \text{ GHz}$	dBm		14.5	
$t_{\text{D}}$	Group Delay $f = 0.5 \text{ GHz}$	psec		200	
$V_{\text{d}}$	Device Voltage	V	3.1	3.5	3.9
$\text{dV}/\text{dT}$	Device Voltage Temperature Coefficient	$\text{mV}/^{\circ}\text{C}$		-8.0	

#### Note:

1. The recommended operating current range for this device is 12 to 30 mA. Typical performance as a function of current is on the following page.

### Ordering Information

Part Numbers	No. of Devices	Comments
MSA-0636-BLKG	100	Bulk
MSA-0636-TR1G	1000	7" Reel

**MSA-0636 Typical Scattering Parameters ( $Z_0 = 50 \Omega$ ,  $T_A = 25^\circ\text{C}$ ,  $I_d = 16 \text{ mA}$ )**

Freq. GHz	$S_{11}$		$S_{21}$			$S_{12}$			$S_{22}$		k
	Mag	Ang	dB	Mag	Ang	dB	Mag	Ang	Mag	Ang	
0.1	.03	-178	20.5	10.59	171	-23.4	.068	5	.04	-44	1.05
0.2	.02	-177	20.3	10.31	161	-22.9	.071	8	.05	-68	1.04
0.3	.02	-164	20.0	9.96	152	-22.4	.076	14	.06	-87	1.04
0.4	.02	-116	19.6	9.55	144	-22.0	.079	19	.07	-104	1.03
0.5	.02	-100	19.2	9.08	136	-21.8	.081	21	.09	-114	1.04
0.6	.04	-89	18.7	8.59	128	-21.3	.086	24	.09	-123	1.04
0.8	.07	-96	17.7	7.66	115	-20.2	.098	29	.10	-140	1.03
1.0	.10	-108	16.6	6.79	103	-19.4	.107	31	.11	-156	1.02
1.5	.17	-134	14.2	5.13	79	-17.2	.138	30	.12	172	1.03
2.0	.24	-160	12.1	4.01	60	-15.8	.163	26	.12	148	1.04
2.5	.31	-178	10.3	3.26	48	-15.1	.175	27	.12	140	1.08
3.0	.37	166	8.7	2.72	34	-14.4	.190	24	.11	135	1.10
3.5	.42	151	7.4	2.33	21	-13.9	.203	19	.10	144	1.11
4.0	.46	139	6.2	2.04	9	-13.3	.216	16	.08	167	1.11
4.5	.48	126	5.1	1.81	-3	-12.8	.229	12	.08	-173	1.11
5.0	.52	110	4.2	1.62	-15	-12.2	.245	8	.09	-173	1.09

**Typical Performance,  $T_A = 25^\circ\text{C}$** 

(unless otherwise noted)

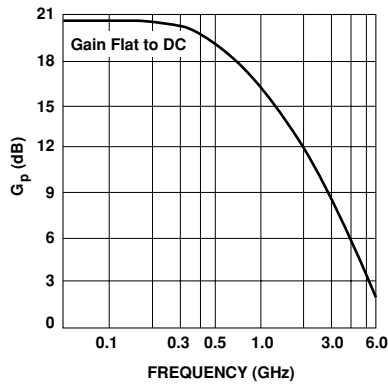
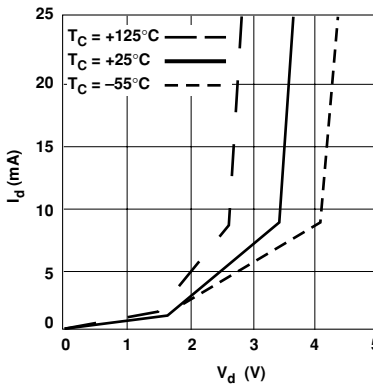
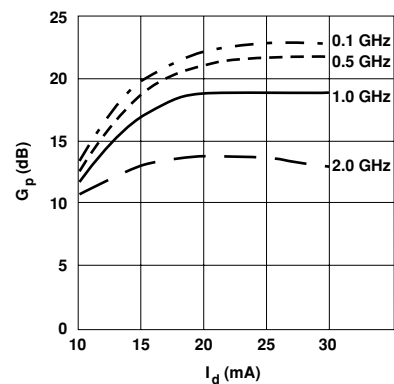
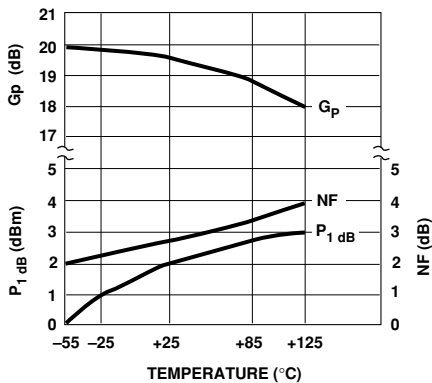
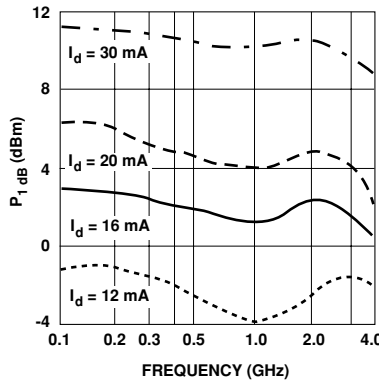
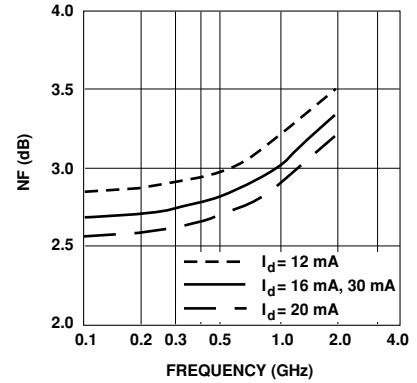
**Figure 1. Typical Power Gain vs. Frequency,  $I_d = 16 \text{ mA}$ .**

**Figure 2. Device Current vs. Voltage.**

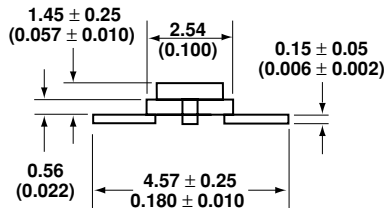
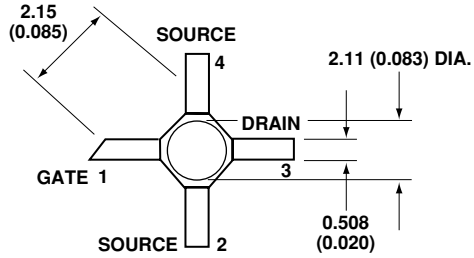
**Figure 3. Power Gain vs. Current.**

**Figure 4. Output Power at 1 dB Gain Compression, NF and Power Gain vs. Case Temperature,  $f = 0.5 \text{ GHz}$ ,  $I_d = 16 \text{ mA}$ .**

**Figure 5. Output Power at 1 dB Gain Compression vs. Frequency.**

**Figure 6. Noise Figure vs. Frequency.**

## 36 micro-X Package Dimensions



### Notes:

1. Dimensions are in millimeters (inches)
2. Tolerances: in .xxx = ± 0.005  
mm .xx = ± 0.13



For product information and a complete list of distributors, please go to our web site: [www.avagotech.com](http://www.avagotech.com)

Avago, Avago Technologies, and the A logo are trademarks of Avago Technologies, Limited in the United States and other countries. Data subject to change. Copyright © 2007 Avago Technologies, Limited. All rights reserved. Obsoletes 5989-2743EN AV02-0304EN - April 12, 2007

**AVAGO**  
TECHNOLOGIES

## Looking for pricing, stock, or lifecycle information?

Click below to explore more details on WIN SOURCE:

-  [View MSA-0636-TR1G on WIN SOURCE](#)
-  [Broadcom Limited Information](#)

## Optimize Your Supply Chain with WIN SOURCE Solutions

-  Global Sourcing Solution
-  Obsolete Management
-  Cost Control Management
-  Shortage Management
-  Alternative Solution
-  Excess Inventory Management