



**THE DATASHEET OF
LTC4413EDD-2#PBF**



LTC4413-1/LTC4413-2

Dual 2.6A, 2.5V to 5.5V Fast Ideal Diodes in 3mm × 3mm DFN

FEATURES

- 2-Channel Ideal Diode OR'ing or Load Sharing
- Low Loss Replacement for PowerPath™ OR'ing Diodes
- Fast Response Replacement for LTC4413
- Low Forward On-Resistance (140mΩ Max at 3.6V)
- Low Reverse Leakage Current
- Low Regulated Forward Voltage (18mV Typ)
- Overvoltage Protection Sensor with Drive Output for an External P-Channel MOSFET (LTC4413-2 Only)
- 2.5V to 5.5V Operating Range
- 2.6A Maximum Forward Current
- Internal Current Limit Protection
- Internal Thermal Protection
- Status Output to Indicate if Selected Channel is Conducting
- Programmable Channel On/Off
- Low Profile (0.75mm) 10-Lead 3mm × 3mm DFN Package

APPLICATIONS

- Battery and Wall Adapter Diode OR'ing in Handheld Products
- Backup Battery Diode OR'ing
- Power Switching
- USB Peripherals
- Uninterruptable Supplies

DESCRIPTION

The **LTC®4413-1** and **LTC4413-2** each contain two monolithic ideal diodes, each capable of supplying up to 2.6A from input voltages between 2.5V and 5.5V. The ideal diodes use a 100mΩ P-channel MOSFET to independently connect INA to OUTA and INB to OUTB. During normal forward operation, the voltage drops across each of these diodes are regulated to as low as 18mV. Quiescent current is less than 80μA for diode currents up to 1A. If either of the output voltages exceeds its respective input voltage, that MOSFET is turned off and less than 1μA of reverse current flows from OUT to IN. Maximum forward current in each MOSFET is limited to a constant 2.6A and internal thermal limiting circuits protect the part during fault conditions. An internal overvoltage protection sensor detects when a voltage exceeds the LTC4413-2 absolute maximum voltage tolerance.

Two active-high control pins independently turn off the two ideal diodes contained within the LTC4413-1/LTC4413-2. When the selected channel is reverse biased, or the LTC4413-1/LTC4413-2 is put into low power standby, the status signal is pulled low by an 11μA open drain.

The LTC4413-1/LTC4413-2 are housed in a 10-lead 3mm × 3mm DFN package.

LT, LT, LTC, LTM, Linear Technology and the Linear logo are registered trademarks and ThinSOT and PowerPath are trademarks of Analog Devices, Inc. All other trademarks are the property of their respective owners.

TYPICAL APPLICATION

Automatic Switchover from a Battery to a Wall Adapter

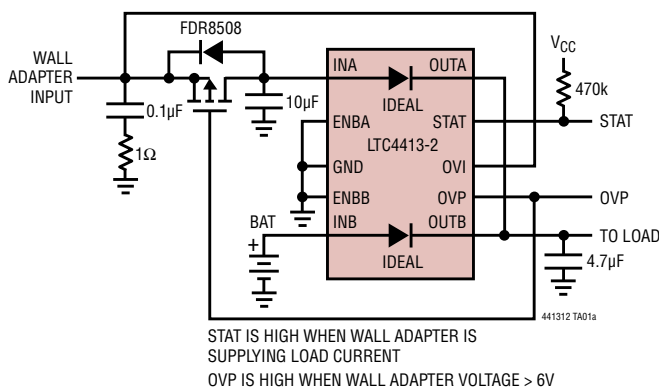

Power Loss vs Load

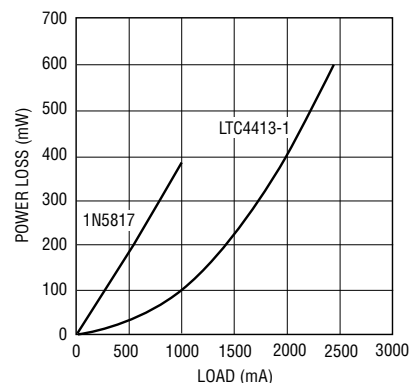

LTC4413-1/LTC4413-2

ABSOLUTE MAXIMUM RATINGS (Note 1)

INA, INB, OUTA, OUTB, STAT,
 ENBA, ENBB Voltage -0.3V to 6V
 OVI, OVP Voltage -0.3V to 13V
 Operating Temperature Range -40°C to 85°C

Storage Temperature Range -65°C to 125°C
 Continuous Power Dissipation 1500mW
 (Derate 25mW/°C Above 70°C)

PIN CONFIGURATION

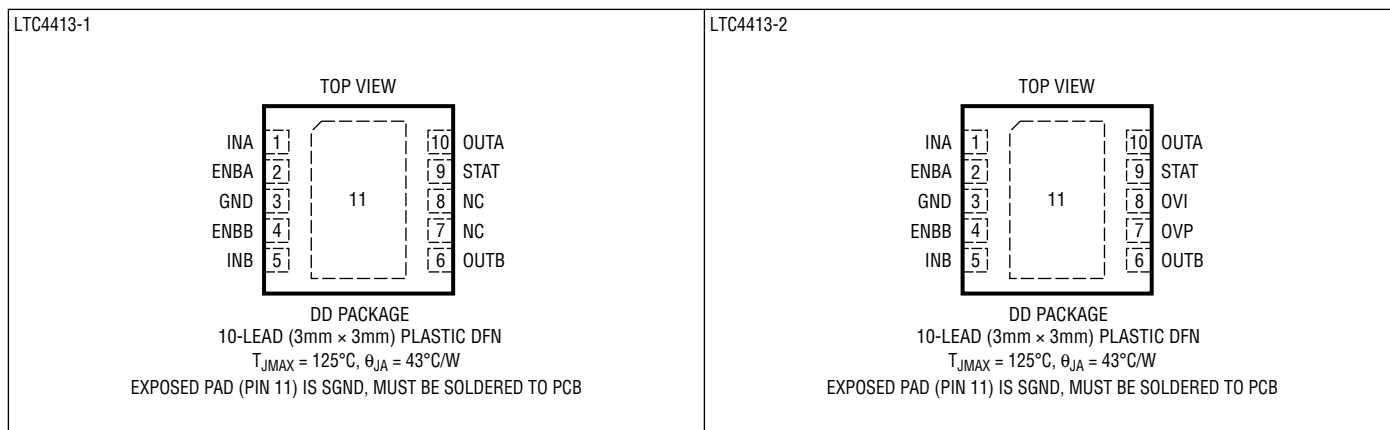

ORDER INFORMATION <http://www.linear.com/product/LTC4413-1#orderinfo>

LEAD FREE FINISH	TAPE AND REEL	PART MARKING	PACKAGE DESCRIPTION	TEMPERATURE RANGE
LTC4413EDD-1#PBF	LTC4413EDD-1#TRPBF	LCPP	10-Lead (3mm × 3mm) Plastic DFN	-40°C to 85°C
LTC4413EDD-2#PBF	LTC4413EDD-2#TRPBF	LCPQ	10-Lead (3mm × 3mm) Plastic DFN	-40°C to 85°C
LEAD BASED FINISH	TAPE AND REEL	PART MARKING	PACKAGE DESCRIPTION	TEMPERATURE RANGE
LTC4413EDD-1	LTC4413EDD-1#TR	LCPP	10-Lead (3mm × 3mm) Plastic DFN	-40°C to 85°C
LTC4413EDD-2	LTC4413EDD-2#TR	LCPQ	10-Lead (3mm × 3mm) Plastic DFN	-40°C to 85°C

Consult LTC Marketing for parts specified with wider operating temperature ranges.

For more information on lead free part marking, go to: <http://www.linear.com/leadfree/>

For more information on tape and reel specifications, go to: <http://www.linear.com/tapeandree/>. Some packages are available in 500 unit reels through designated sales channels with #TRMPBF suffix.

ELECTRICAL CHARACTERISTICS

The ● denotes the specifications which apply over the full operating temperature range, otherwise specifications are at $T_A = 25^\circ\text{C}$. (Notes 2, 6)

SYMBOL	PARAMETER	CONDITIONS		MIN	TYP	MAX	UNITS
V_{IN}, V_{OUT}	Operating Supply Range for Channel A or B	V_{IN} and/or V_{OUT} Must be in This Range for Proper Operation	●	2.5		5.5	V
UVLO	UVLO Turn-On Rising Threshold	Max ($V_{INA}, V_{INB}, V_{OUTA}, V_{OUTB}$)	●			2.45	V
	UVLO Turn-Off Falling Threshold	Max ($V_{INA}, V_{INB}, V_{OUTA}, V_{OUTB}$)	●	1.7			V
I_{QF}	Quiescent Current in Forward Regulation, Measured via GND	$V_{INA} = 3.6\text{V}, I_{INA} = 100\text{mA}, V_{INB} = 0\text{V}, I_{INB} = 0\text{mA}$ (Note 3)	●		40	58	μA
I_{QRIN}	Current Drawn from or Sourced into I_N When V_{OUT} is Greater than V_{IN}	$V_{IN} = 3.6\text{V}, V_{OUT} = 5.5\text{V}$ (Note 6)	●	-1	2.5	4.5	μA
I_{QRGND}	Quiescent Current While in Reverse Turn-Off, Measured via GND	$V_{INA} = V_{INB} = 0\text{V}, V_{OUTB} = V_{OUTA} = 5.5\text{V}, V_{STAT} = 0\text{V}$			28	36	μA
I_{QROUTB}	Quiescent Current While in Reverse Turn-Off. Current Drawn from V_{OUTA} When $OUTB$ Supplies Chip Power	$V_{INA} = V_{INB} = 0\text{V}, V_{OUTA} = 3.6\text{V}, V_{OUTB} = 5.5\text{V}$	●		3.5	6.5	μA
I_{QOFF}	Quiescent Current with Both ENBA and ENBB High	$V_{INA} = V_{INB} = 3.6\text{V}, V_{ENBA} = V_{ENBB} = 1\text{V}$	●		28	38	μA
V_{RTO}	Reverse Turn-Off Voltage ($V_{OUT} - V_{IN}$)	$V_{IN} = 3.6\text{V}$	●	-5		10	mV
V_{FWD}	Forward Voltage Drop ($V_{IN} - V_{OUT}$) at $I_{OUT} = -1\text{mA}$	$V_{IN} = 3.6\text{V}$	●		18	24	mV
R_{FWD}	On-Resistance, R_{FWD} Regulation (Measured as $\Delta V/\Delta I$)	$V_{IN} = 3.6\text{V}, I_{OUT} = -100\text{mA}$ to -500mA (Note 5)			100	140	$\text{m}\Omega$
R_{ON}	On-Resistance, R_{ON} Regulation (Measured as V/I at $I_{IN} = 1\text{A}$)	$V_{IN} = 3.6\text{V}, I_{IN} = 1\text{A}$ (Note 5)			140	200	$\text{m}\Omega$
t_{ON}	PowerPath Turn-On Time	$V_{IN} = 3.6\text{V}$, from ENBA, ENBB Falling to I_{OUT} Ramp Starting			11		μs
t_{OFF}	PowerPath Turn-Off Time	$V_{IN} = 3.6\text{V}$, from ENBA, ENBB Rising with $I_{IN} = 100\text{mA}$ Falling to 0mA			2		μs
Short-Circuit Response							
I_{OC}	Current Limit	V_{INA} OR $B = 3.6\text{V}$ (Note 5)		1.8			A
I_{QOC}	Quiescent Current While in Overcurrent Operation	V_{INA} OR $B = 3.6\text{V}, I_{OUT} = 1.8\text{A}$ (Note 5)			100	130	μA
STAT Output							
I_{SOFF}	STAT Off Current	Shut Down	●	-1	0	1	μA
I_{SON}	STAT Sink Current	$V_{IN} > V_{OUT}, V_{ENB} > V_{ENBIH}, T_J < 135^\circ\text{C}, I_{OUT} < I_{MAX}$	●	7	11	15	μA
$t_{S(ON)}$	STAT Pin Current Turn-On Time	$V_{IN} = 3.6\text{V}$, from ENBA, ENBB Falling			1.8		μs
$t_{S(OFF)}$	STAT Pin Current Turn-Off Time	$V_{IN} = 3.6\text{V}$, from ENBA, ENBB Rising			0.8		μs
ENB Inputs							
V_{ENBIH}	ENB Inputs Rising Threshold Voltage	V_{ENBA}, V_{ENBB} Rising	●		540	600	mV
V_{ENBIL}	ENB Inputs Falling Threshold Voltage	V_{ENBA}, V_{ENBB} Falling	●	400	460		mV
V_{ENBHYS}	ENB Input Hysteresis	$V_{ENBHYS} = (V_{ENBIH} - V_{ENBIL})$			90		mV
I_{ENB}	ENB Inputs Pull-Down Current	$V_{OUT} < V_{IN} = 3.6\text{V}, V_{ENBA} < V_{ENBIL}, V_{ENBB} < V_{ENBIL}$	●	2	3	4	μA

LTC4413-1/LTC4413-2

ELECTRICAL CHARACTERISTICS

The ● denotes the specifications which apply over the full operating temperature range, otherwise specifications are at $T_A = 25^\circ\text{C}$. (Notes 2, 6)

SYMBOL	PARAMETER	CONDITIONS	MIN	TYP	MAX	UNITS
OVI Input (LTC4413-2 Only)						
V_{OVIH}	OVI Input Rising Threshold Voltage	V_{OVI} Rising		5.9	6.2	V
$V_{OVI L}$	OVI Input Falling Threshold Voltage	V_{OVI} Falling	5.4	5.6		V
V_{OVID}	OVI-OVP Voltage Drop	$V_{OVI} = 8\text{V}$, No Load at OVP		100		mV
I_{OVI}	OVI Bias Current	$V_{OVI} = 8\text{V}$		80		μA

Note 1: Stresses beyond those listed under Absolute Maximum Ratings may cause permanent damage to the device. Exposure to any Absolute Maximum Rating condition for extended periods may affect device reliability and lifetime.

Note 2: The LTC4413-1/LTC4413-2 are guaranteed to meet performance specifications from 0°C to 85°C . Specifications over the -40°C to 85°C operating temperature range are assured by design, characterization and correlation with statistical process controls.

Note 3: Quiescent current increases with diode current: refer to plot of I_{QF} vs I_{OUT} .

Note 4: This IC includes overtemperature protection that is intended to protect the device during momentary overload conditions. Overtemperature protection will become active at a junction temperature greater than the maximum operating temperature. Continuous operation above the specified maximum operating junction temperature may impair device reliability.

Note 5: Specification is guaranteed by correlation to wafer-level measurements.

Note 6: Unless otherwise specified, current into a pin is positive and current out of a pin is negative. All voltages referenced to GND.

TYPICAL PERFORMANCE CHARACTERISTICS

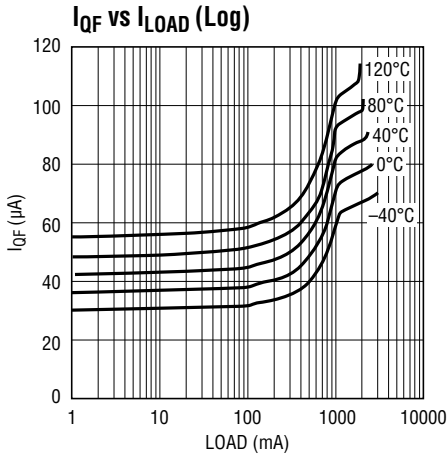

441312 G01

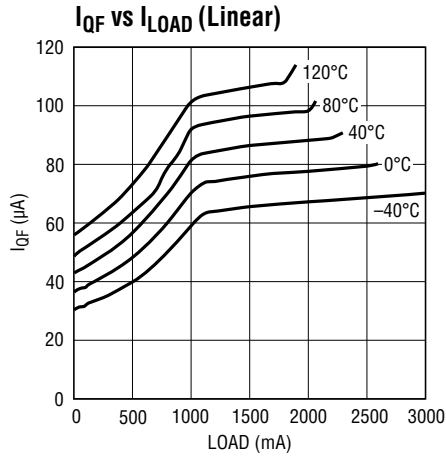

441312 G02

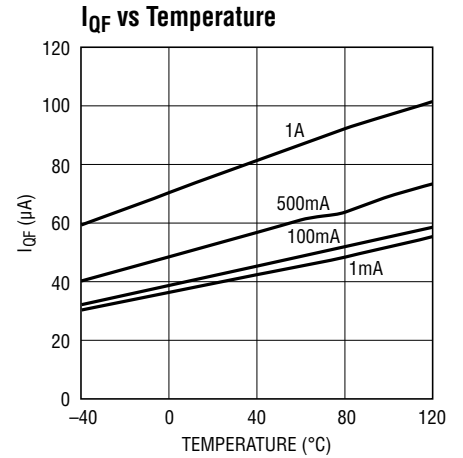

441312 G03

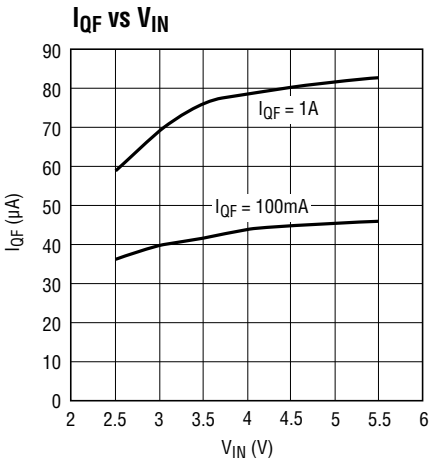

441312 G04

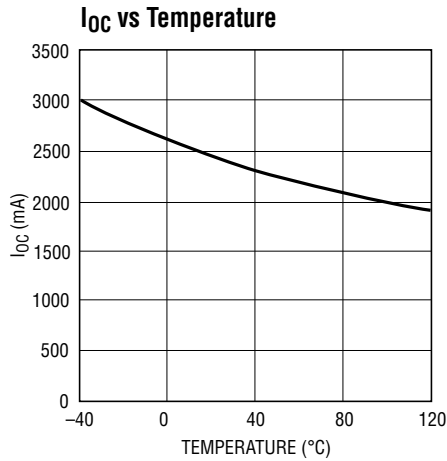

441312 G05

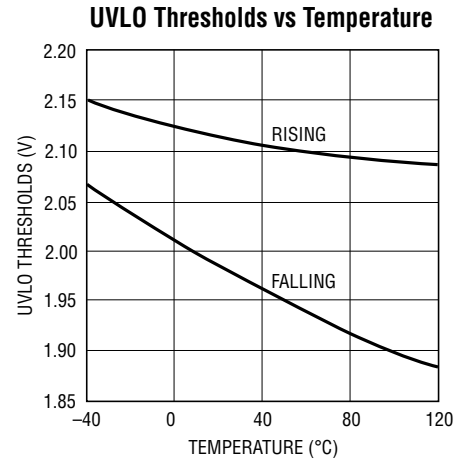

441312 G06

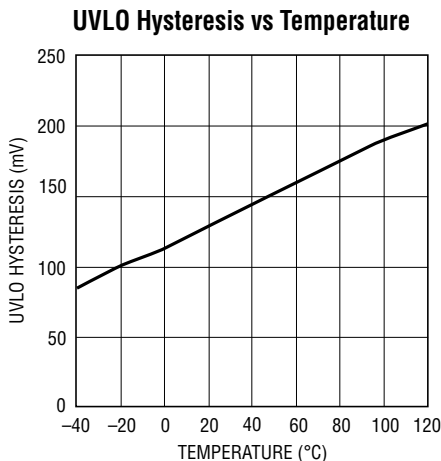

441312 G07

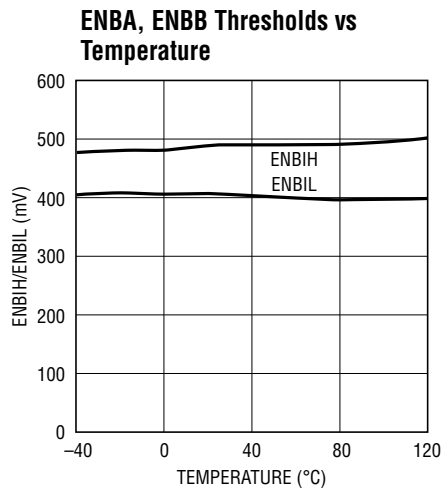

441312 G08

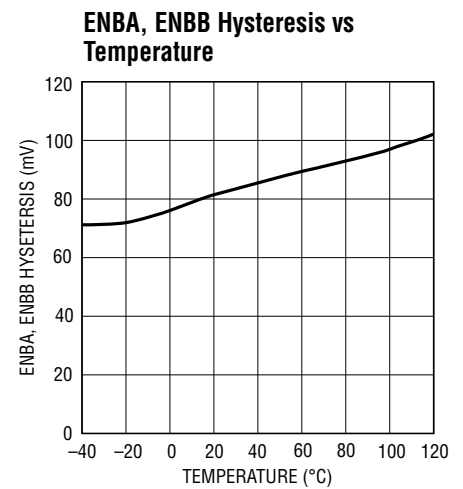

441312 G09

TYPICAL PERFORMANCE CHARACTERISTICS

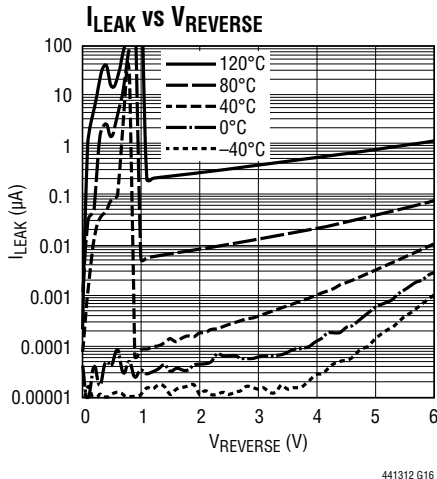
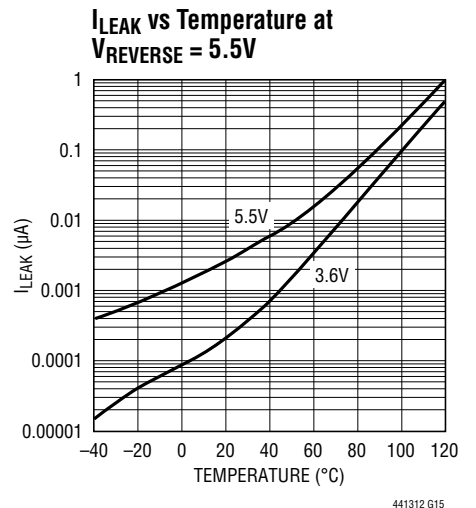
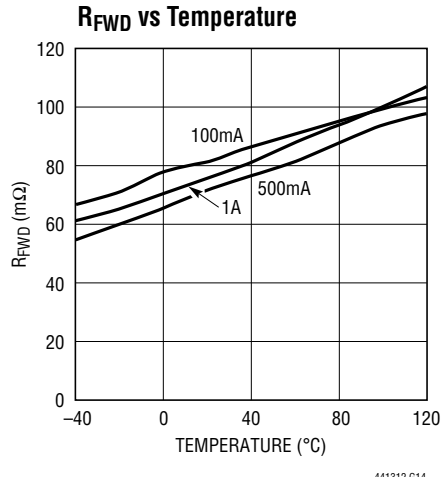
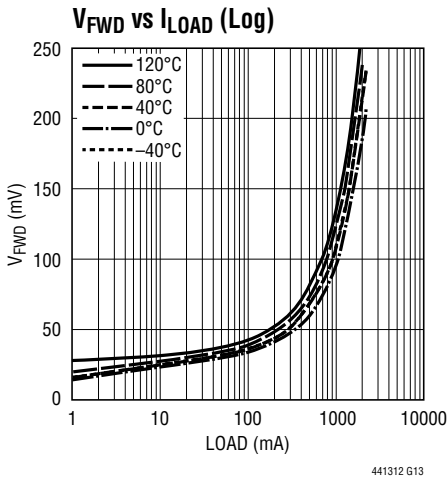
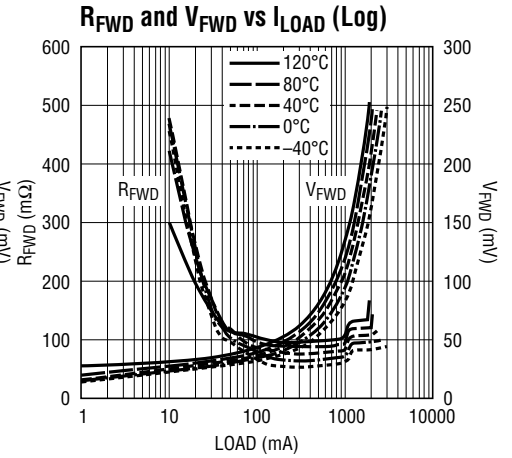
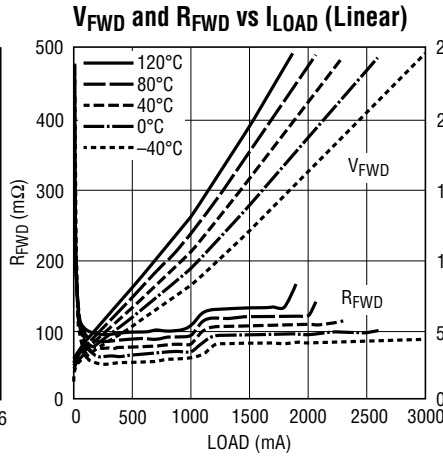
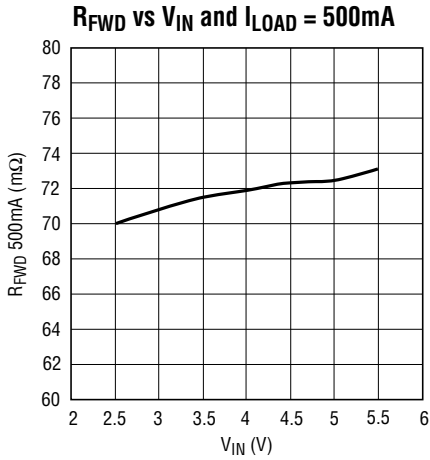

Response to 800mA Load Step in <16μs

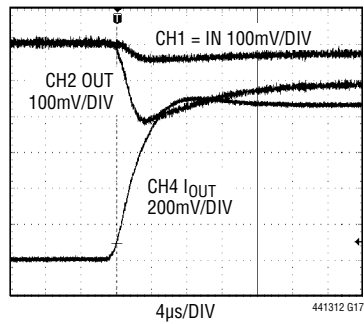

ENBA, ENBB Turn-On, 30μs to Turn On with 180mA Load

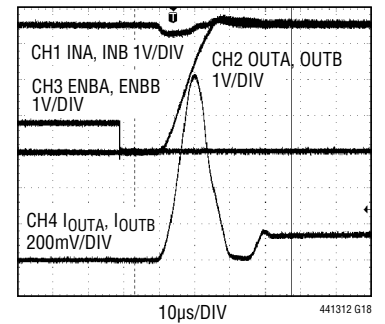

TYPICAL PERFORMANCE CHARACTERISTICS

ENBA, ENBB Turn-Off, 2 μ s to Disconnect IN from 180mA Load

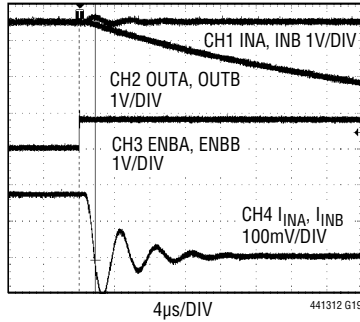

Efficiency vs Load Current

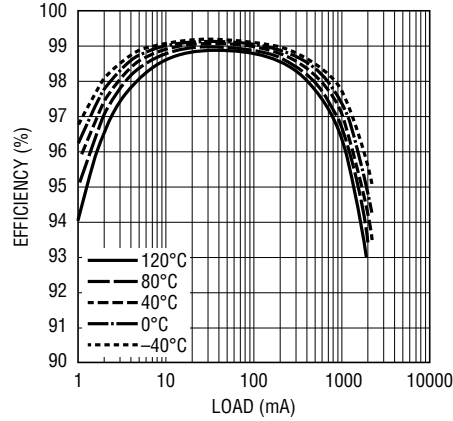

Power Loss vs Load Current

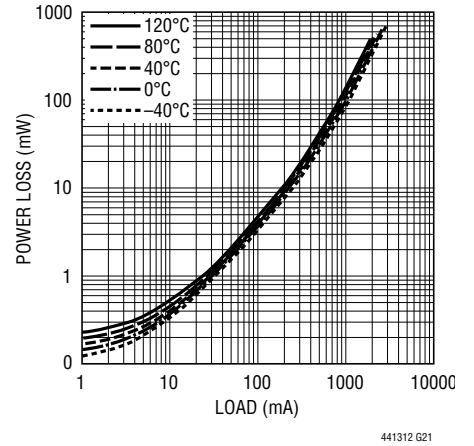

Overvoltage Thresholds vs Temperature (LTC4413-2 Only)

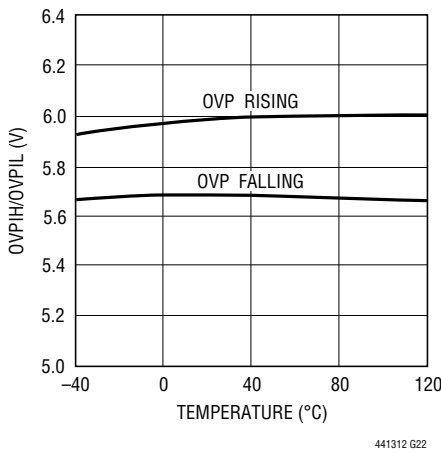

Overvoltage Hysteresis vs Temperature (LTC4413-2 Only)

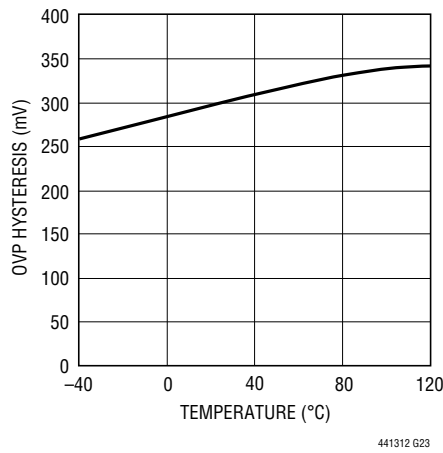

OVI Current vs Voltage (LTC4413-2 Only)

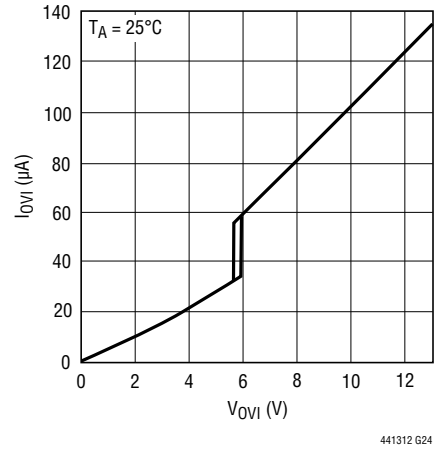

OVI-OVP Voltage Drop vs OVI Voltage (LTC4413-2 Only)

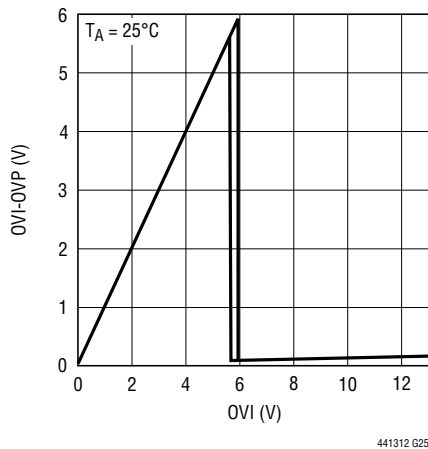

I_Q OVI vs Temperature (LTC4413-2 Only)

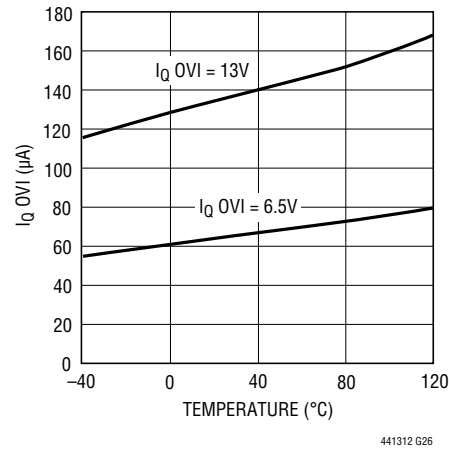

OVI-OVP vs Temperature (LTC4413-2 Only)

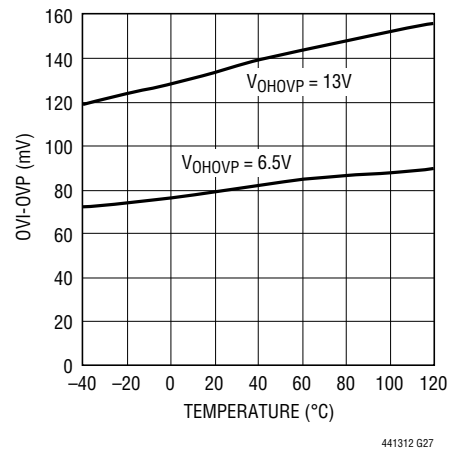

PIN FUNCTIONS

INA (Pin 1): Primary Ideal Diode Anode and Positive Power Supply for LTC4413-1/LTC4413-2. Bypass INA with a ceramic capacitor of at least 1 μ F. (Series 1 Ω snub resistors and higher valued capacitances are recommended when large inductances are in series with this input.) This pin can be grounded when not used. Limit slew rate on this pin to less than 2.5V/ μ s.

ENBA (Pin 2): Enable Low for Diode A. Pull this pin high to shut down this power path. Tie to GND to enable. Refer to Table 1 for mode control functionality. This pin can be left floating, a weak (3.5 μ A) pull-down internal to LTC4413-1/LTC4413-2 is included.

GND (Pin 3): Power Ground for the IC.

ENBB (Pin 4): Enable Low for Diode B. Pull this pin high to shut down this power path. Tie to GND to enable. Refer to Table 1 for mode control functionality. This pin can be left floating, a weak (3.5 μ A) pull-down internal to LTC4413-1/LTC4413-2 is included.

INB (Pin 5): Secondary Ideal Diode Anode and Positive Power Supply for LTC4413-1/LTC4413-2. Bypass INB with a ceramic capacitor of at least 1 μ F. (Series 1 Ω snub resistors and higher valued capacitances are recommended when large inductances are in series with this input.) This pin can be grounded when not used. Limit slew rate on this pin to less than 2.5V/ μ s.

OUTB (Pin 6): Secondary Ideal Diode Cathode and Output of the LTC4413-1/LTC4413-2. Bypass OUTB with a high (1m Ω min) ESR ceramic capacitor of at least 4.7 μ F. This pin must be left floating when not in use. Limit slew rate on this pin to less than 2.5V/ μ s.

OVP (Pin 7, LTC4413-2 Only): Drive Output for an External OVP Switch PMOS Transistor (To Inhibit Overvoltage Wall Adapter Voltages from Damaging Device.) During overvoltage conditions, this output will remain high so long as an overvoltage condition persists. This pin must be left floating when not in use.

OVI (Pin 8, LTC4413-2 Only): Sense Input for Overvoltage Protection Block. This pin can be left floating or grounded when not used.

STAT (Pin 9): Status Condition Indicator. Weak (11 μ A) pull-down current output. When terminated, high indicates diode conducting. Refer to Table 2 for the operation of this pin. This pin can also be left floating or grounded.

OUTA (Pin 10): Primary Ideal Diode Cathode and Output of the LTC4413-1/LTC4413-2. Bypass OUTA with a high (1m Ω min) ESR ceramic capacitor of at least 4.7 μ F. This pin must be left floating when not in use. Limit slew rate on this pin to less than 2.5V/ μ s.

SGND (Exposed Pad Pin 11): Signal Ground. This pin must be soldered to PCB ground to provide both electrical contact to ground and good thermal contact to PCB.

BLOCK DIAGRAM

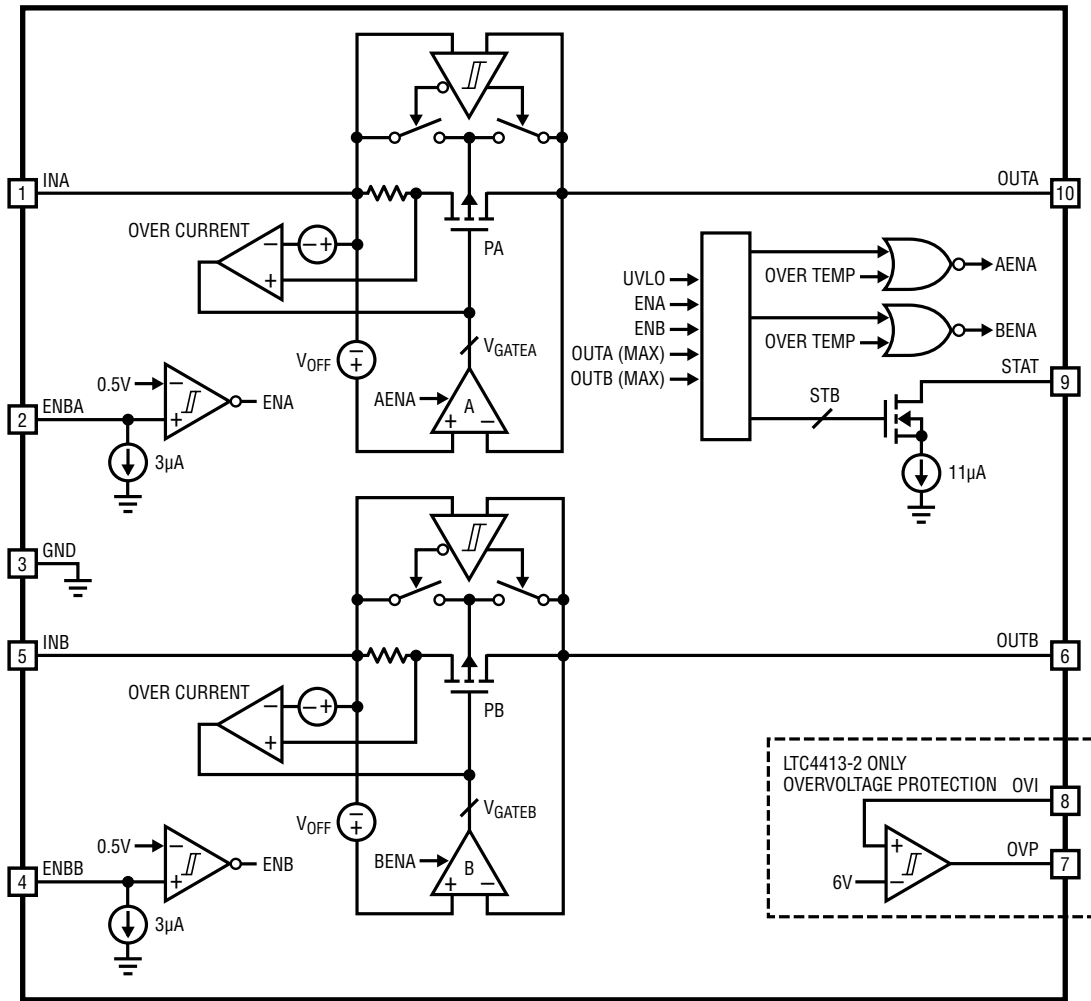

OPERATION

The LTC4413-1/LTC4413-2 are described with the aid of the Block Diagram. Operation begins when the power source at V_{INA} or V_{INB} rises above the undervoltage lockout (UVLO) voltage of 2.4V and the corresponding control pin ENBA or ENBB is low. If only the voltage at the V_{INA} pin is present, the internal power source (V_{DD}) is supplied from the V_{INA} pin. The amplifier (A) pulls a current proportional to the difference between V_{INA} and V_{OUTA} from the gate (V_{GATEA}) of the internal PFET (PA), driving this gate voltage below V_{INA} . This turns on PA. As V_{OUTA} pulls up to a forward voltage drop (V_{FWD}) of 15mV below V_{INA} , the LTC4413 regulates V_{GATEA} to maintain the small forward voltage drop. The system is now in forward regulation and the load at V_{OUTA} is powered from the supply at V_{INA} . As the load current varies, V_{GATEA} is controlled to maintain V_{FWD} until the load current exceeds the transistor's (PA) ability to deliver the current as V_{GATEA} approaches GND. At this point, the PFET behaves as a fixed resistor, R_{ON} , whereby the forward voltage increases slightly with increased load current. As the magnitude of I_{OUT} increases further, (such that $I_{LOAD} > I_{OC}$) the LTC4413-1/LTC4413-2 fixes the load current to the constant value I_{OC} to protect the device. The characteristics for parameters R_{FWD} , R_{ON} , V_{FWD} and I_{OC} are specified with the aid of Figure 1, illustrating the LTC4413-1/LTC4413-2 forward voltage drop versus that of a Schottky.

If another supply is provided at V_{INB} , the LTC4413-1/LTC4413-2 likewise regulate the gate voltage on PB to

maintain the output voltage, V_{OUTB} , just below the input voltage V_{INB} . If this alternate supply, V_{INB} , exceeds the voltage at V_{INA} , the LTC4413-1/LTC4413-2 selects this input voltage as the internal supply (V_{DD}). This second ideal diode operates independently of the first ideal diode function.

When an alternate power source is connected to the load at V_{OUTA} (or V_{OUTB}), the LTC4413-1/LTC4413-2 sense the increased voltage at V_{OUTA} , and amplifier A increases the voltage V_{GATEA} , reducing the current through PA. When V_{OUTA} is higher than $V_{INA} + V_{RTO}$, V_{GATEA} will be pulled up to V_{DD} , turning off PA. The internal power source for the LTC4413-1/LTC4413-2 (V_{DD}) then diverts to draw current from the V_{OUTA} pin, only if V_{OUTA} is larger than V_{INB} (or V_{OUTB}). The system is now in the reverse turn-off mode. Power to the load is being delivered from an alternate supply, and only a small current (I_{LEAK}) is drawn from or sourced to V_{INA} to sense the potential at V_{INA} .

When the selected channel of the LTC4413-1/LTC4413-2 is in reverse turn-off mode or both channels are disabled, the STAT pin sinks 11 μ A of current (I_{SON}) if connected.

Channel selection is accomplished using the two pins, ENBA and ENBB. For example with channel A, when the ENBA input is asserted (high), PA has its gate voltage pulled to V_{DD} , turning off PA. A 3.5 μ A pull-down current on the ENBA, ENBB pins ensures a low level at these inputs if left floating.

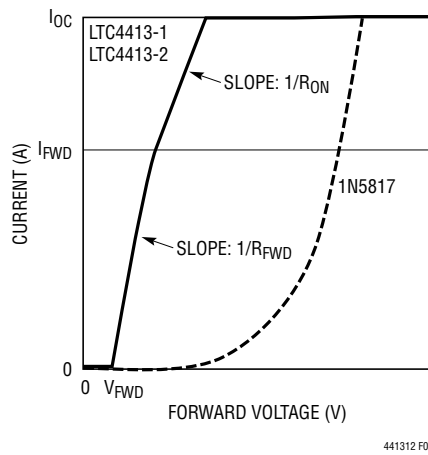

Figure 1. The LTC4413 vs the 1N5817

OPERATION

Overcurrent and Short-Circuit Protection

During an overcurrent condition, the output voltage droops as the load current exceeds the amount of current that the LTC4413-1/LTC4413-2 can supply. At the time when an overcurrent condition is first detected, the LTC4413-1/LTC4413-2 take some time to detect this condition before reducing the current to I_{OC} . For short durations after the output is shorted, until TOC, the current may exceed I_{OC} . The magnitude of this peak short-circuit current can be large depending on the load current immediately before the short-circuit occurs. During overcurrent operation, the power consumption of the LTC4413-1/LTC4413-2 is large, and is likely to cause an overtemperature condition as the internal die temperature exceeds the thermal shutdown temperature.

Overtemperature Protection

The overtemperature condition is detected when the internal die temperature increases beyond 150°C. An overtemperature condition will cause the gate amplifiers (A and B) as well as the two P-channel MOSFETs (PA and PB) to shut off. When the internal die temperature cools to below 140°C, the amplifiers turn on and the LTC4413-1/LTC4413-2 reverts to normal operation. Note that prolonged operation under overtemperature conditions degrades reliability.

Overvoltage Protection (LTC4413-2 Only)

An overvoltage condition is detected whenever the overvoltage input (OVI) pin is pulled above 6V. The condition persists until the OVI voltage falls below 5.6V. The overvoltage protection (OVP) output is low unless an overvoltage condition is detected. If an overvoltage condition is present, the OVP output is pulled up to the voltage applied to the OVI input. This output signal can be used to enable or disable an external PFET that is placed between the input that is the source of the excessive voltage and the input to the LTC4413-2, thus eliminating the potential damage that may occur to the LTC4413-2 if its input voltage exceeds the absolute maximum voltage of 6V. See the Applications Information section *Dual Battery Load Sharing with Automatic Switchover to a Wall Adapter with Overvoltage*

Protection for more information on using the overvoltage protection function within the LTC4413-2.

Channel Selection and Status Output

Two active-high control pins independently turn off the two ideal diodes contained within the LTC4413-1/LTC4413-2, controlling the operation mode as described by Table 1. When the selected channel is reverse biased, or the LTC4413-1/LTC4413-2 is put into low power standby, the status signal indicates this condition with a low voltage.

Table 1. Mode Control

ENBA	ENBB	STATE
Low	Low	Diode'OR NB: The Two Outputs are not Connected Internal to the Device
Low	High	Diode A = ENABLED, Diode B = DISABLED
High	Low	Diode A = DISABLED, Diode B = ENABLED
High	High	All Off (Low Power Standby)

The function of the STAT pin depends on the mode that has been selected. Table 2 describes the STAT pin output current, as a function of the mode selected as well as the conduction state of the two diodes.

Table 2. STAT Output Pin Function

ENBA	ENBB	CONDITIONS	STAT
Low	Low	Diode A Forward Bias, Diode B Forward Bias	$I_{SNK} = 0\mu A$
		Diode A Forward Bias, Diode B Reverse Bias	$I_{SNK} = 0\mu A$
		Diode A Reverse Bias, Diode B Forward Bias	$I_{SNK} = 11\mu A$
		Diode A Reverse Bias, Diode B Reverse Bias	$I_{SNK} = 11\mu A$
Low	High	Diode A Forward Bias, Diode B Disabled	$I_{SNK} = 0\mu A$
		Diode A Reverse Bias, Diode B Disabled	$I_{SNK} = 11\mu A$
High	Low	Diode A Disabled, Diode B Forward Bias	$I_{SNK} = 0\mu A$
		Diode A Disabled, Diode B Reverse Bias	$I_{SNK} = 11\mu A$
High	High	Diode A Disabled, Diode B Disabled	$I_{SNK} = 11\mu A$

APPLICATIONS INFORMATION

Automatic Switchover from a Battery to an Auxiliary Supply, or a Wall Adapter with Overvoltage Protection

Figure 4 illustrates an application circuit where the LTC4413-2 is used to automatically switch over between a battery, an auxiliary power supply and a wall adapter. When the battery is supplying load current, OVP is at GND and STAT is high. If a higher supply is applied to AUX, the BAT will be disconnected from the load and the load is powered from AUX. When a wall adapter is applied, the body diode of MP2 forward biases. When the load voltage exceeds the AUX (or BAT) voltage, the LTC4413-2 senses this higher voltage and disconnects AUX (or BAT) from the load. At the same time it pulls the STAT voltage to GND, thereby turning on MP2. The load current is now supplied from the wall adapter. If the wall adapter voltage exceeds the OVI rising threshold, the OVP voltage rises and turns off MP1, disconnecting the wall adapter from the load. The output voltage collapses down to the AUX (or BAT) voltage and the LTC4413-2 reconnects the load to AUX (or BAT).

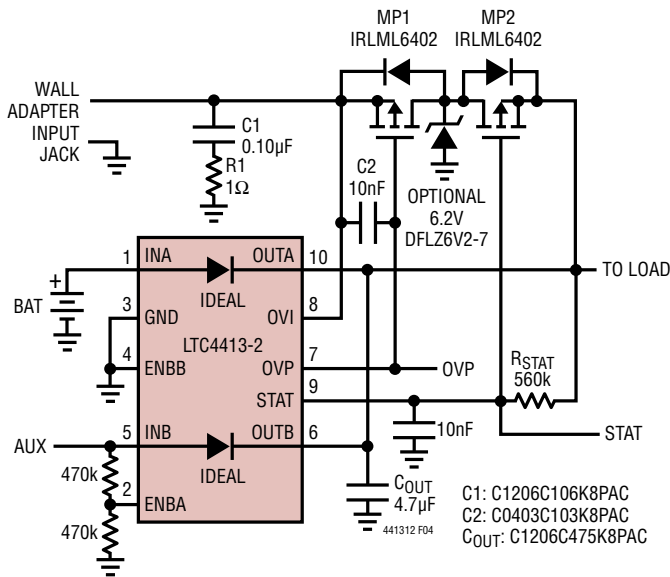

Figure 4

Capacitor C2 is required to dynamically pull up on the gate of MP1 if a fast edge occurs at the wall adapter input during a hot plug. If the wall adapter voltage is precharged when an overvoltage spike occurs, the OVP voltage may not discharge capacitor C2 in time to protect the output. In this event, a Zener diode is recommended to protect the output node until MP1 is turned off.

Multiple Battery Charging

Figure 5 illustrates an application circuit for automatic dual battery charging from a single charger. Whichever battery has the lower voltage will receive the larger charging current until both battery voltages are equal, then both are charged. While both batteries are charging simultaneously, the higher capacity battery gets proportionally higher current from the charger. For Li-Ion batteries, both batteries achieve the float voltage minus the forward regulation voltage of 15mV. This concept can apply to more than two batteries. The STAT pin provides information as to when the battery at OUTA is being charged. For intelligent control, the ENBA/ENBB input pins can be used with a microcontroller as shown in Figure 3.

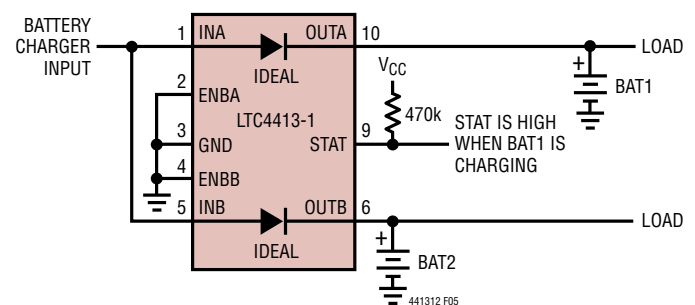

Figure 5

LTC4413-1/LTC4413-2

PACKAGE DESCRIPTION

Please refer to <http://www.linear.com/product/LTC4413-1#packaging> for the most recent package drawings.

DD Package 10-Lead Plastic DFN (3mm × 3mm) (Reference LTC DWG # 05-08-1699 Rev C)

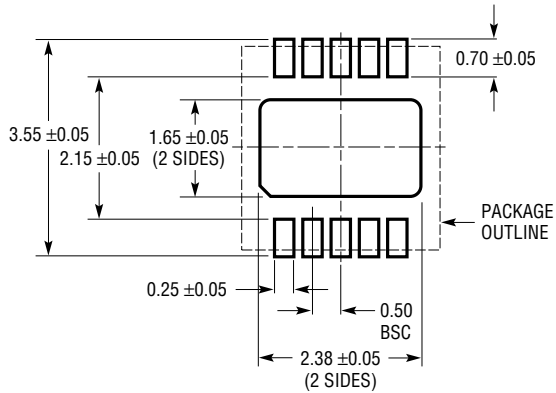

RECOMMENDED SOLDER PAD PITCH AND DIMENSIONS

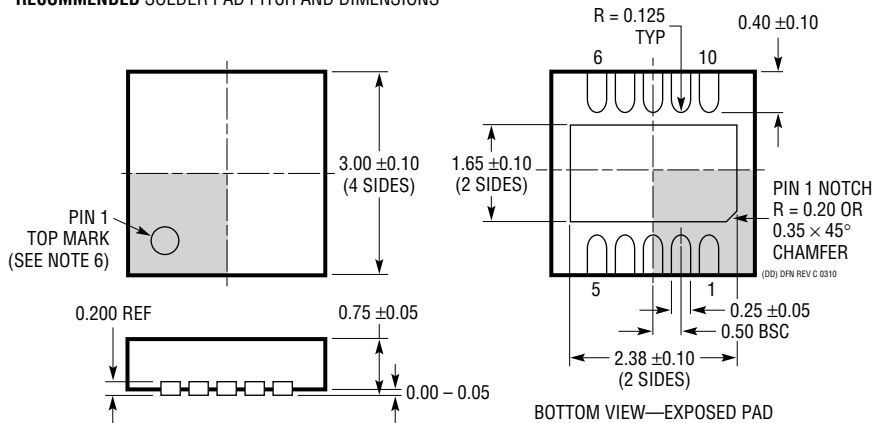

NOTE:

1. DRAWING TO BE MADE A JEDEC PACKAGE OUTLINE M0-229 VARIATION OF (WEED-2). CHECK THE LTC WEBSITE DATA SHEET FOR CURRENT STATUS OF VARIATION ASSIGNMENT
2. DRAWING NOT TO SCALE
3. ALL DIMENSIONS ARE IN MILLIMETERS
4. DIMENSIONS OF EXPOSED PAD ON BOTTOM OF PACKAGE DO NOT INCLUDE MOLD FLASH. MOLD FLASH, IF PRESENT, SHALL NOT EXCEED 0.15mm ON ANY SIDE
5. EXPOSED PAD SHALL BE SOLDER PLATED
6. SHADED AREA IS ONLY A REFERENCE FOR PIN 1 LOCATION ON THE TOP AND BOTTOM OF PACKAGE

REVISION HISTORY (Revision history begins at Rev E)

REV	DATE	DESCRIPTION	PAGE NUMBER
E	07/15	Changed GND to SGND in Pin Configuration	2
		Changed V_{ENB} to $V_{ENBA,B}$ in electrical characteristics	3
		Changed ENB to ENBA,B last two plots	4
		Changed ENB to ENBA,B last plot	5
		Changed ENB to ENBA,B first plot and changed IN to INA,B	6
		Changed exposed pad/SGND label	7
		Added sentence to final paragraph and added A,B references	9
		Changed to ENBA and ENBB on Tables 1 and 2	10
		Added LTC4415 to Related Parts table	16
F	09/16	Changed y-axis on graph G27 to OVI-OVP	7
G	09/17	Changed MP2 diode connection Figures 2, 4	12, 13

TYPICAL APPLICATION

Automatic Switchover from a Battery to a Wall Adapter with Soft-Start Overvoltage Protection

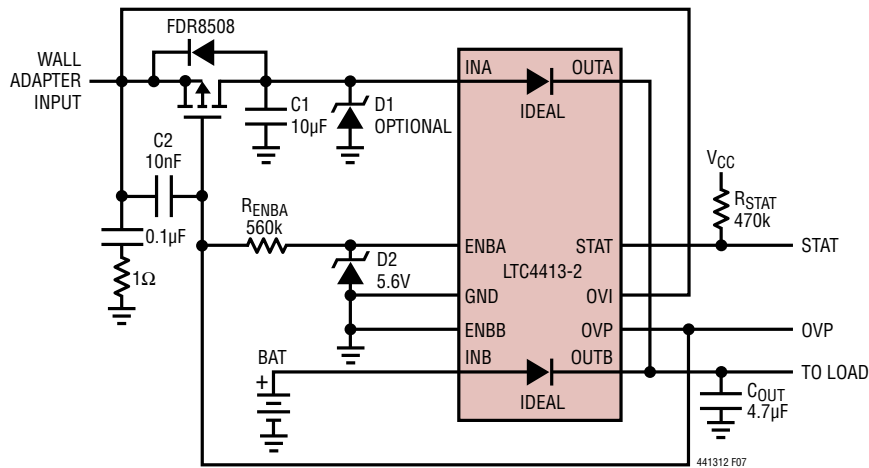

C1: C0805C106K8PAC
 C2: C0403C103K8PAC
 COUT: C1206C475K8PAC

STAT IS HIGH WHEN WALL ADAPTER IS SUPPLYING LOAD CURRENT
 OVP IS HIGH WHEN WALL ADAPTER VOLTAGE > 6V

RELATED PARTS

PART NUMBER	DESCRIPTION	COMMENTS
LTC1558/LTC1559	Backup Battery Controller with Programmable Output	Adjustable Backup Voltage from 1.2V NiCd Button Cell, Includes Boost Converter
LTC1998	2.5µA, 1% Accurate Programmable Battery Detector	Adjustable Trip Voltage/Hysteresis, ThinSOT™
LTC4054	800mA Standalone Linear Li-Ion Battery Charger with Thermal Regulation in ThinSOT	No External MOSFET, Sense Resistor or Blocking Diode Required, Charge Current Monitor for Gas Gauging, C/10 Charge Termination
LTC4350	Hot Swappable Load Share Controller	Allows N + 1 Redundant Supply, Equally Loads Multiple Power Supplies Connected in Parallel
LTC4411	2.6A Low Loss Ideal Diode in ThinSOT	No External MOSFET, Automatic Switching Between DC Sources, Simplified Load Sharing
LTC4412/LTC4412HV	PowerPath Controller in ThinSOT	More Efficient than Diode OR'ing, Automatic Switching Between DC Sources, Simplified Load Sharing, $3V \leq V_{IN} \leq 28V$, $3V \leq V_{IN} \leq 36V$ (HV)
LTC4413	Dual 2.6A, 2.5V to 5.5V, Ideal Diodes in 3mm × 3mm DFN	Lower Quiescent Current with Slower Response Time
LTC4414	36V, Low Loss PowerPath Controller for Large PFETs	Drives Large Q _G PFETs, Very Low Loss Replacement for Power Supply O'Ring Diodes, 3.5V to 36V AC/DC Adapter Voltage Range, 8-Lead MSOP Package
LTC4415	Dual 4A Ideal Diodes with Adjustable Current Limit	1.7V to 5.5V Operating Range, 50mΩ PMOS, Soft-Start, 15mV Forward Drop, MSOP-16 and 3mm × 5mm DFN-16 Packages

Looking for pricing, stock, or lifecycle information?

Click below to explore more details on WIN SOURCE:

 [View LTC4413EDD-2#PBF on WIN SOURCE](#)

 [Linear Technology](#) Information

Optimize Your Supply Chain with WIN SOURCE Solutions

-  Global Sourcing Solution
-  Obsolete Management
-  Cost Control Management
-  Shortage Management
-  Alternative Solution
-  Excess Inventory Management