



THE DATASHEET OF AD8566ARMZ-REEL



FEATURES

- Single-supply operation: 4.5 V to 16 V
- Input capability beyond the rails
- Rail-to-rail output swing
- Continuous output current: 35 mA
- Peak output current: 250 mA
- Offset voltage: 10 mV
- Slew rate: 6 V/ μ s
- Unity gain stable with large capacitive loads
- Supply current: 700 μ A per amplifier
- Qualified for automotive applications

APPLICATIONS

- LCD reference drivers
- Portable electronics
- Communications equipment
- Automotive infotainment systems

GENERAL DESCRIPTION

The AD8565/AD8566/AD8567 are low cost, single-supply, rail-to-rail input and output operational amplifiers optimized for LCD monitor applications. They are built on an advanced high voltage CBCMOS process. The AD8565 contains a single amplifier, the AD8566 has two amplifiers, and the AD8567 has four amplifiers.

These LCD op amps have high slew rates, 35 mA continuous output drive, 250 mA peak output drive, and a high capacitive load drive capability. They have a wide supply range and offset voltages below 10 mV. The AD8565/AD8566/AD8567 are ideal for LCD grayscale reference buffer and V_{COM} applications.

The AD8565/AD8566/AD8567 are specified over the -40°C to $+85^{\circ}\text{C}$ temperature range. The AD8565 single is available in a 5-lead SC70 package. The AD8566 dual is available in an 8-lead MSOP package. The AD8567 quad is available in a 14-lead TSSOP package and a 16-lead LFCSP package.

The AD8566WARMZ is the automotive grade version.

PIN CONFIGURATIONS

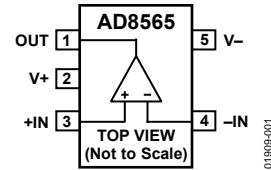

Figure 1. 5-Lead SC70 Pin Configuration

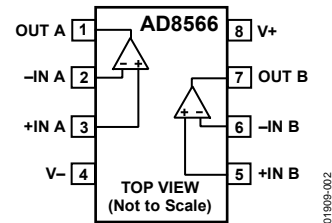

Figure 2. 8-Lead MSOP Pin Configuration

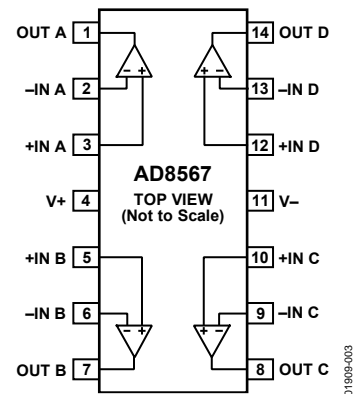
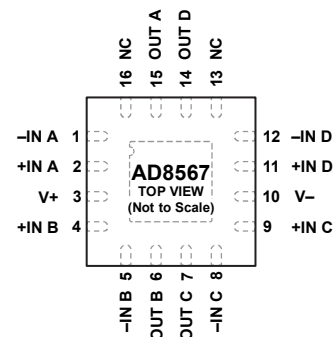

Figure 3. 14-Lead TSSOP Pin Configuration



- NOTES
1. THE EXPOSED PAD MUST BE CONNECTED TO PIN 3, THAT IS, $V+$.
 2. NC = NO CONNECT.

Figure 4. 16-Lead LFCSP Pin Configuration

Rev. H

[Document Feedback](#)

Information furnished by Analog Devices is believed to be accurate and reliable. However, no responsibility is assumed by Analog Devices for its use, nor for any infringements of patents or other rights of third parties that may result from its use. Specifications subject to change without notice. No license is granted by implication or otherwise under any patent or patent rights of Analog Devices. Trademarks and registered trademarks are the property of their respective owners.

TABLE OF CONTENTS

Features	1
Applications.....	1
General Description	1
Pin Configurations	1
Revision History	2
Specifications.....	3
Electrical Characteristics	3
Absolute Maximum Ratings.....	4
Thermal Resistance	4
ESD Caution.....	4
Typical Performance Characteristics	5

REVISION HISTORY

10/2017—Rev. G to Rev. H

Change to Figure 4	1
Changed 16-Lead LFCSP (CP-16-4) to 16-Lead LFCSP (CP-16-23), Table 3.....	4
Updated Outline Dimensions	13
Changes to Ordering Guide	13

3/2010—Rev. F to Rev. G

Changes to Figure 4.....	1
Changes to the Thermal Pad—AD8567 Section	10

1/2010—Rev. E to Rev. F

Changes to Applications and General Description Sections	1
Changes to Figure 4.....	1
Added Exposed Pad Notation to Outline Dimensions	12
Changes to Ordering Guide	13

8/2007—Rev. D to Rev. E

Changes to Features Section.....	1
Changes to Phase Margin	3
Changes to Table 2.....	4
Changes to Figure 30.....	10
Updated Outline Dimensions	12
Changes to Ordering Guide	13

Theory of Operation	9
Input Overvoltage Protection	9
Output Phase Reversal.....	10
Power Dissipation.....	10
Thermal Pad—AD8567	10
Total Harmonic Distortion + Noise (THD + N).....	11
Short-Circuit Output Conditions.....	11
LCD Panel Applications	11
Outline Dimensions	12
Ordering Guide	13

2/2006—Rev. C to Rev. D

Updated Format.....	Universal
Changes to Figure 6 and Figure 8.....	5
Added the Thermal Pad—AD8567 Section.....	10
Changes to Ordering Guide	13

3/2004—Rev. B to Rev. C

Changes to Specifications.....	2
Changes to TPC 4.....	4
Changes to TPC 10.....	5
Changes to TPC 14.....	6
Changes to TPC 20.....	7

12/2003—Rev. A to Rev. B

Updated Ordering Guide	3
Updated Outline Dimensions	11

10/2001—Rev. 0 to Rev. A

Edit to 16-Lead CSP and 5-Lead SC70 Pin Configuration	1
Edit to Ordering Guide.....	3

7/2001—Revision 0: Initial Version

SPECIFICATIONS

ELECTRICAL CHARACTERISTICS

$4.5\text{ V} \leq V_S \leq 16\text{ V}$, $V_{CM} = V_S/2$, $T_A = 25^\circ\text{C}$, unless otherwise noted.

Table 1.

Parameter	Symbol	Conditions	Min	Typ	Max	Unit
INPUT CHARACTERISTICS						
Offset Voltage	V_{OS}			2	10	mV
Offset Voltage Drift	$\Delta V_{OS}/\Delta T$	$-40^\circ\text{C} \leq T_A \leq +85^\circ\text{C}$		5		$\mu\text{V}/^\circ\text{C}$
Input Bias Current	I_B	$-40^\circ\text{C} \leq T_A \leq +85^\circ\text{C}$		80	600	nA
Input Offset Current	I_{OS}	$-40^\circ\text{C} \leq T_A \leq +85^\circ\text{C}$		1	80	nA
Input Voltage Range		Common-mode input	-0.5		$V_S + 0.5$	V
Common-Mode Rejection Ratio	CMRR	$V_{CM} = 0\text{ V to } V_S$, $-40^\circ\text{C} \leq T_A \leq +85^\circ\text{C}$	54	95		dB
Large Signal Voltage Gain	A_{VO}	$R_L = 10\text{ k}\Omega$, $V_O = 0.5\text{ V to } (V_S - 0.5\text{ V})$	3	10		V/mV
Input Impedance	Z_{IN}			400		k Ω
Input Capacitance	C_{IN}			1		pF
OUTPUT CHARACTERISTICS						
Output Voltage High	V_{OH}	$I_L = 100\ \mu\text{A}$ $V_S = 16\text{ V}$, $I_L = 5\text{ mA}$ $-40^\circ\text{C} \leq T_A \leq +85^\circ\text{C}$	15.85	$V_S - 0.005$ 15.95		V
		$V_S = 4.5\text{ V}$, $I_L = 5\text{ mA}$ $-40^\circ\text{C} \leq T_A \leq +85^\circ\text{C}$	15.75			V
		$V_S = 4.5\text{ V}$, $I_L = 5\text{ mA}$ $-40^\circ\text{C} \leq T_A \leq +85^\circ\text{C}$	4.2	4.38		V
		$V_S = 4.5\text{ V}$, $I_L = 5\text{ mA}$ $-40^\circ\text{C} \leq T_A \leq +85^\circ\text{C}$	4.1			V
Output Voltage Low	V_{OL}	$I_L = 100\ \mu\text{A}$ $V_S = 16\text{ V}$, $I_L = 5\text{ mA}$ $-40^\circ\text{C} \leq T_A \leq +85^\circ\text{C}$		5		mV
		$V_S = 16\text{ V}$, $I_L = 5\text{ mA}$ $-40^\circ\text{C} \leq T_A \leq +85^\circ\text{C}$		42	150	mV
		$V_S = 4.5\text{ V}$, $I_L = 5\text{ mA}$ $-40^\circ\text{C} \leq T_A \leq +85^\circ\text{C}$		95	250	mV
		$V_S = 4.5\text{ V}$, $I_L = 5\text{ mA}$ $-40^\circ\text{C} \leq T_A \leq +85^\circ\text{C}$			300	mV
		$V_S = 4.5\text{ V}$, $I_L = 5\text{ mA}$ $-40^\circ\text{C} \leq T_A \leq +85^\circ\text{C}$			400	mV
Continuous Output Current	I_{OUT}			35		mA
Peak Output Current	I_{PK}	$V_S = 16\text{ V}$		250		mA
POWER SUPPLY						
Supply Voltage	V_S		4.5		16	V
Power Supply Rejection Ratio	PSRR	$V_S = 4\text{ V to } 17\text{ V}$, $-40^\circ\text{C} \leq T_A \leq +85^\circ\text{C}$	70	90		dB
Supply Current/Amplifier	I_{SY}	$V_O = V_S/2$, no load $-40^\circ\text{C} \leq T_A \leq +85^\circ\text{C}$		700	850	μA
					1	mA
DYNAMIC PERFORMANCE						
Slew Rate	SR	$R_L = 10\text{ k}\Omega$, $C_L = 200\text{ pF}$	4	6		V/ μs
Gain Bandwidth Product	GBP	$R_L = 10\text{ k}\Omega$, $C_L = 10\text{ pF}$		5		MHz
Phase Margin	ϕ_m	$R_L = 10\text{ k}\Omega$, $C_L = 10\text{ pF}$		65		Degrees
Channel Separation				75		dB
NOISE PERFORMANCE						
Voltage Noise Density	e_n	$f = 1\text{ kHz}$		26		nV/ $\sqrt{\text{Hz}}$
	e_n	$f = 10\text{ kHz}$		25		nV/ $\sqrt{\text{Hz}}$
Current Noise Density	i_n	$f = 10\text{ kHz}$		0.8		pA/ $\sqrt{\text{Hz}}$

ABSOLUTE MAXIMUM RATINGS

Table 2.

Parameter	Rating
Supply Voltage (V_S)	18 V
Input Voltage	$-0.5\text{ V to }V_S + 0.5\text{ V}$
Differential Input Voltage	V_S
Storage Temperature Range	$-65^\circ\text{C to }+150^\circ\text{C}$
Operating Temperature Range	$-40^\circ\text{C to }+85^\circ\text{C}$
Junction Temperature Range	$-65^\circ\text{C to }+150^\circ\text{C}$
Lead Temperature (Soldering, 60 sec)	300°C

Stresses at or above those listed under Absolute Maximum Ratings may cause permanent damage to the product. This is a stress rating only; functional operation of the product at these or any other conditions above those indicated in the operational section of this specification is not implied. Operation beyond the maximum operating conditions for extended periods may affect product reliability.

THERMAL RESISTANCE

θ_{JA} is specified for worst-case conditions, that is, for a device soldered onto a circuit board for surface-mount packages.

Table 3. Thermal Resistance

Package Type	θ_{JA}	θ_{JC}	Unit
5-Lead SC70 (KS-5)	376	126	$^\circ\text{C/W}$
8-Lead MSOP (RM-8)	210	45	$^\circ\text{C/W}$
14-Lead TSSOP (RU-14)	180	35	$^\circ\text{C/W}$
16-Lead LFCSP (CP-16-23)	38 ¹	30 ¹	$^\circ\text{C/W}$

¹ DAP is soldered down to the printed circuit board (PCB).

ESD CAUTION



ESD (electrostatic discharge) sensitive device.

Charged devices and circuit boards can discharge without detection. Although this product features patented or proprietary protection circuitry, damage may occur on devices subjected to high energy ESD. Therefore, proper ESD precautions should be taken to avoid performance degradation or loss of functionality.

TYPICAL PERFORMANCE CHARACTERISTICS

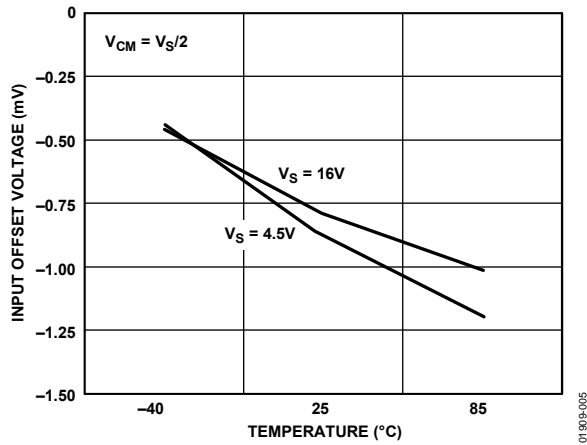

Figure 5. Input Offset Voltage vs. Temperature

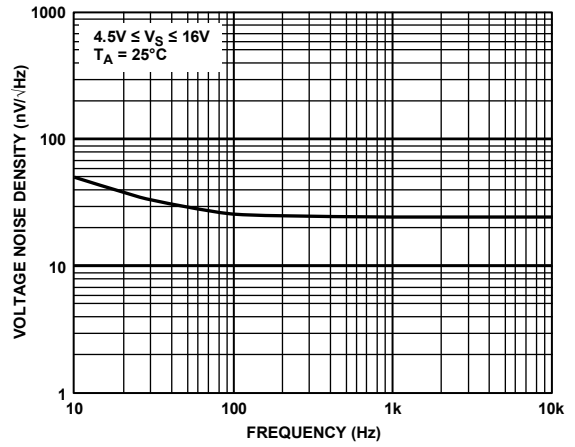

Figure 8. Voltage Noise Density vs. Frequency

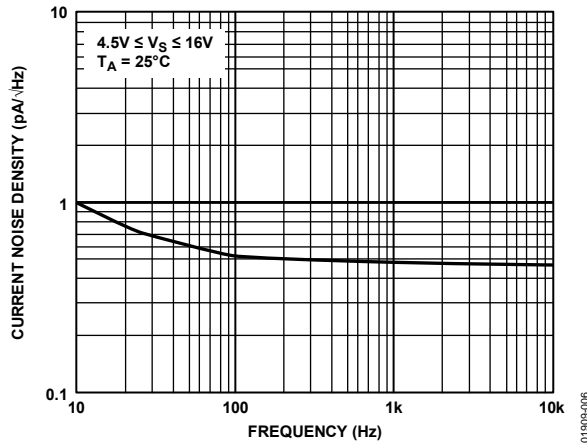

Figure 6. Current Noise

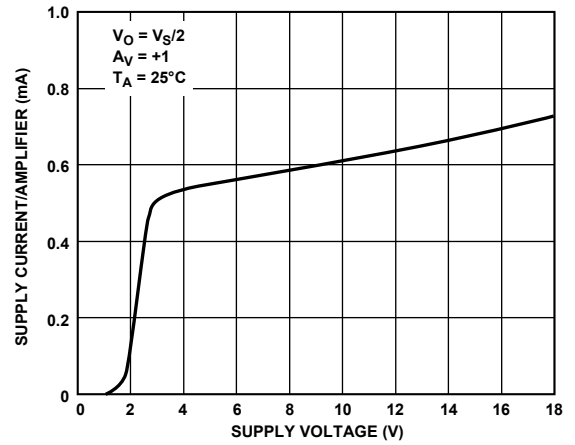

Figure 9. Supply Current/Amplifier vs. Supply Voltage

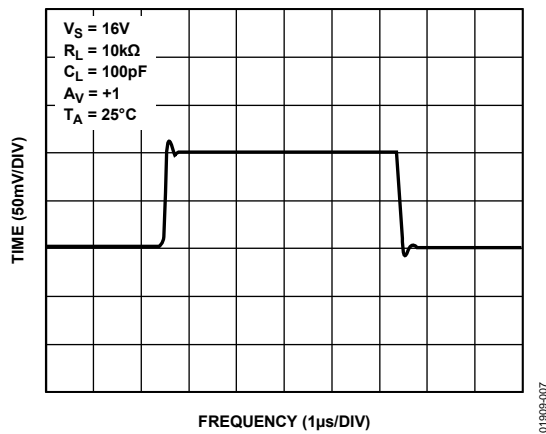

Figure 7. Small Signal Transient Response

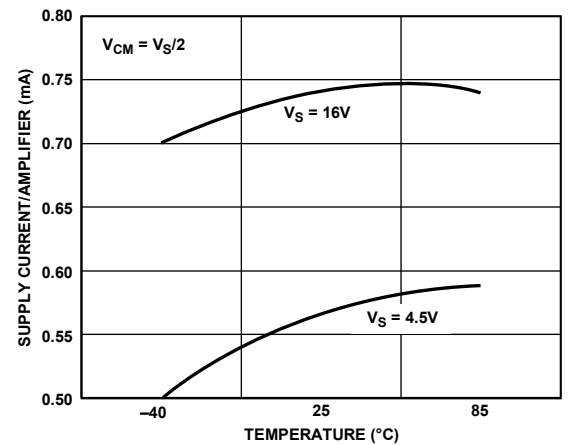

Figure 10. Supply Current/Amplifier vs. Temperature

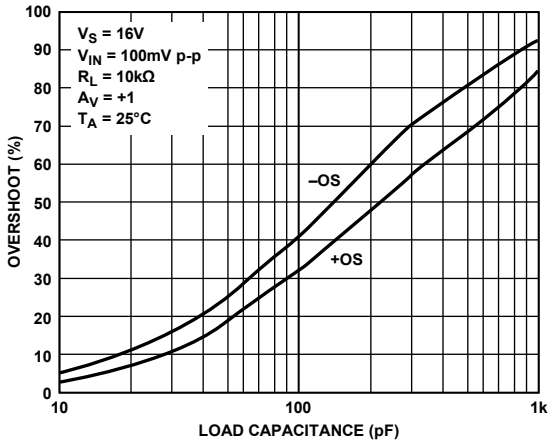

Figure 11. Small Signal Overshoot vs. Load Capacitance

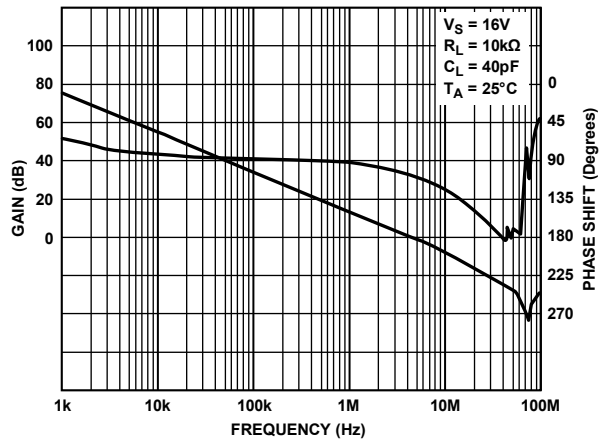

Figure 14. Open-Loop Gain and Phase Shift vs. Frequency

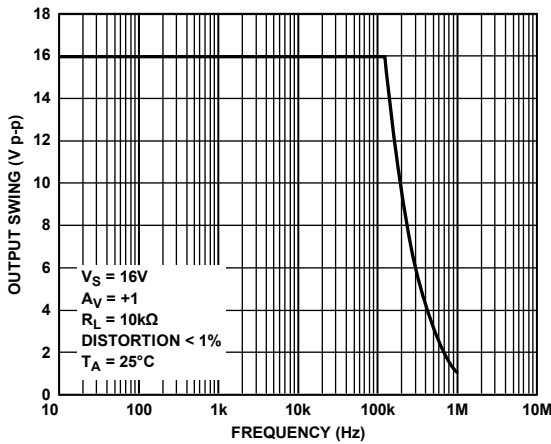

Figure 12. Closed-Loop Output Swing vs. Frequency

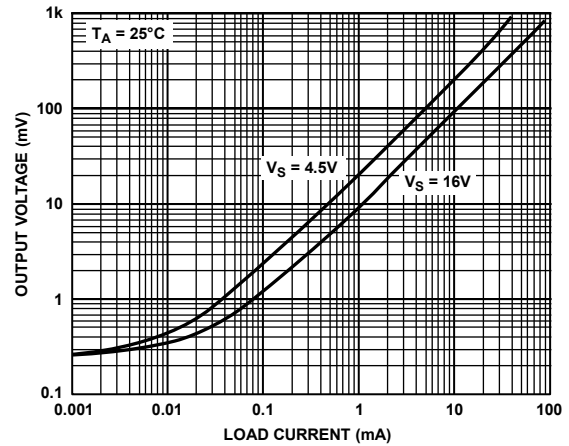

Figure 15. Output Voltage to Supply Rail vs. Load Current

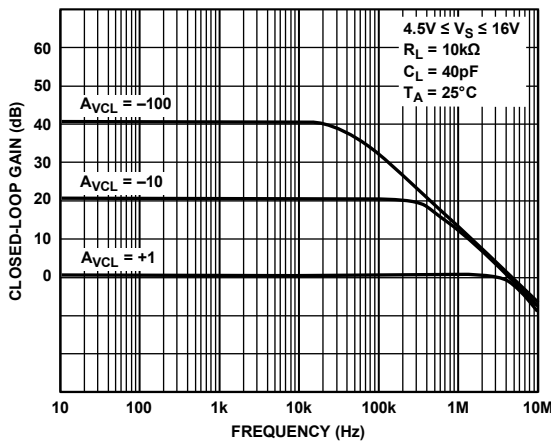

Figure 13. Closed-Loop Gain vs. Frequency

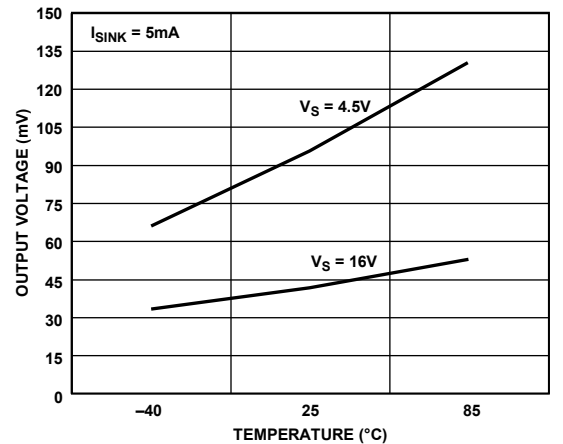

Figure 16. Output Voltage Swing to Rail vs. Temperature

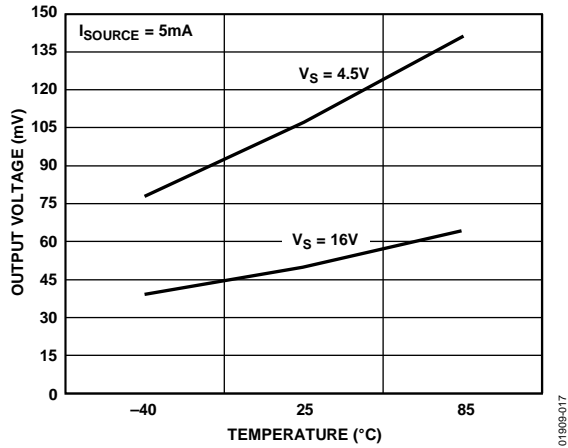

Figure 17. Output Voltage Swing to Rail vs. Temperature

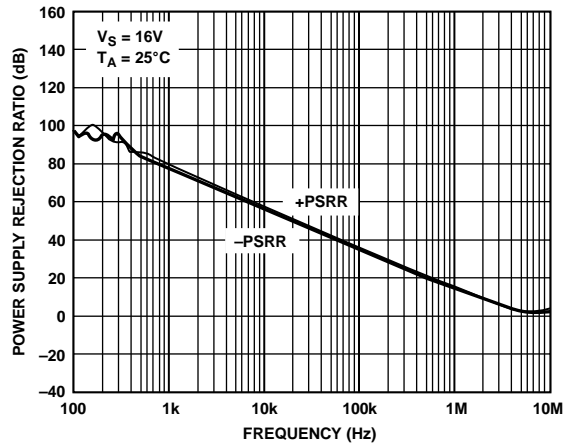

Figure 20. Power Supply Rejection Ratio vs. Frequency

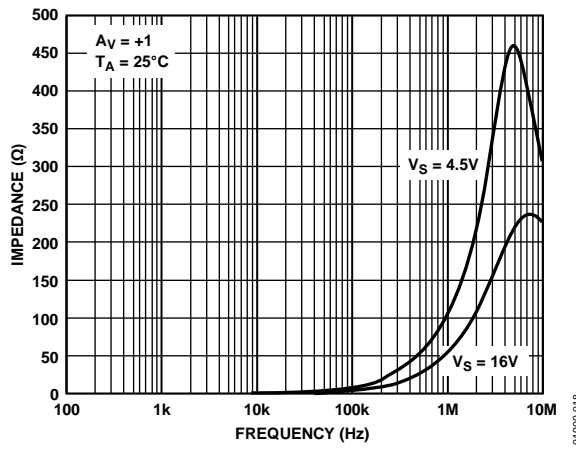

Figure 18. Closed-Loop Output Impedance vs. Frequency

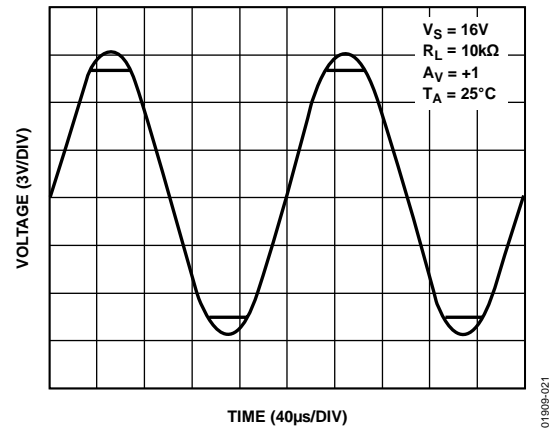

Figure 21. No Phase Reversal

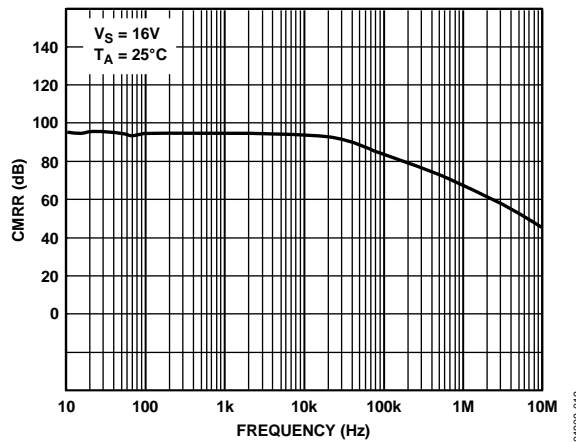

Figure 19. Common-Mode Rejection Ratio (CMRR) vs. Frequency

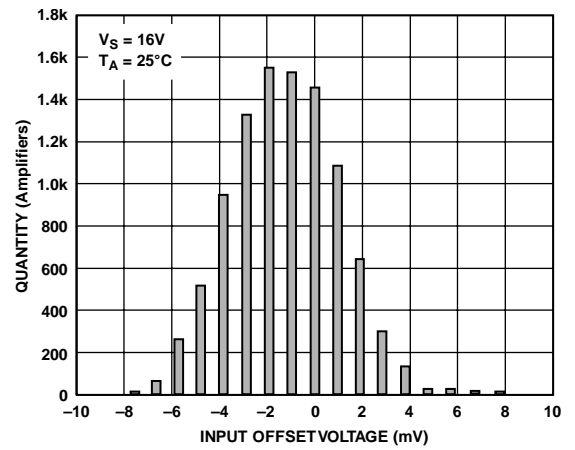

Figure 22. Input Offset Voltage Distribution

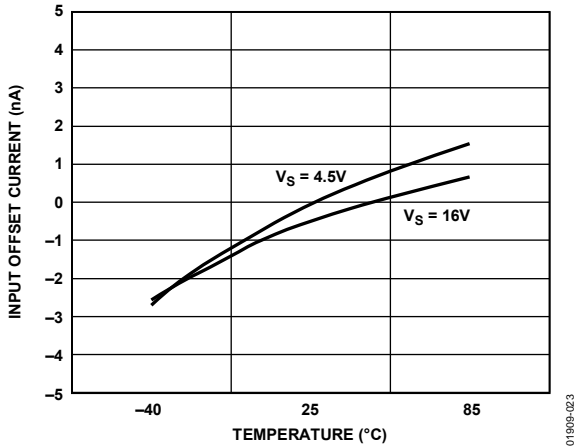

Figure 23. Input Offset Current vs. Temperature

01909-023

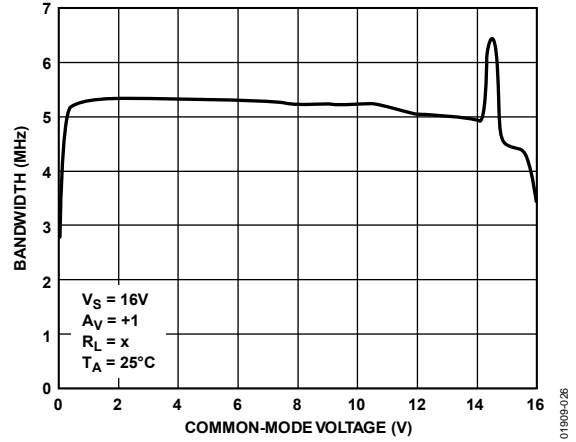

Figure 26. Frequency vs. Common-Mode Voltage ($V_S = 16V$)

01909-026

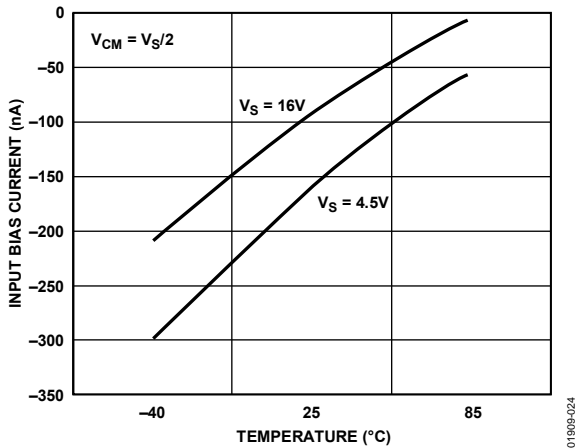

Figure 24. Input Bias Current vs. Temperature

01909-024

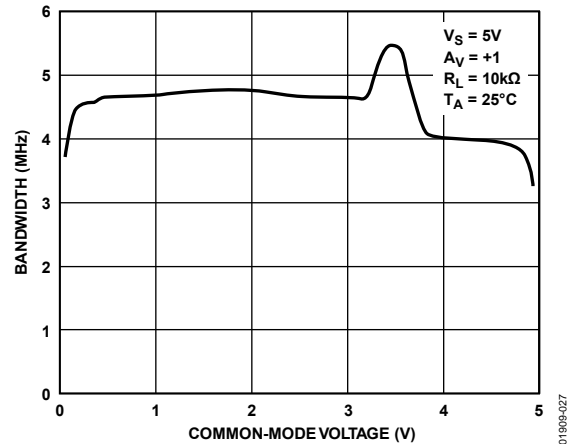

Figure 27. Frequency vs. Common-Mode Voltage ($V_S = 5V$)

01909-027

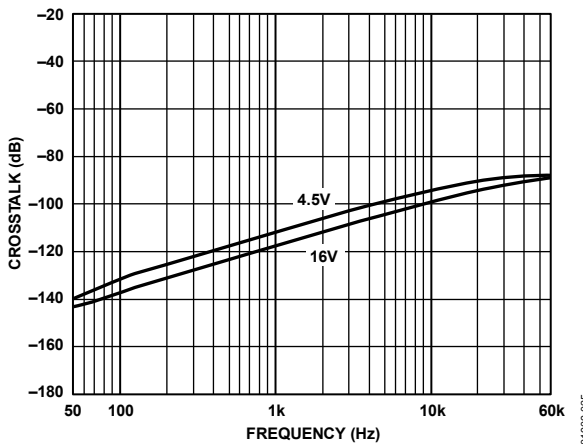

Figure 25. Channel A vs. Channel B Crosstalk

01909-025

THEORY OF OPERATION

The AD8565/AD8566/AD8567 are designed to drive large capacitive loads in LCD applications. They have high output current drive and rail-to-rail input/output operation and are powered from a single 16 V supply. They are also intended for other applications where low distortion and high output current drive are needed.

Figure 28 shows a simplified equivalent circuit for the AD8565/AD8566/AD8567. The rail-to-rail bipolar input stage is composed of two PNP differential pairs, Q4 to Q5 and Q10 to Q11, operating in series with diode protection networks, D1 to D2. Diode network D1 to D2 serves as protection against large transients for Q4 to Q5 to accommodate rail-to-rail input swing. D5 to D6 protect Q10 to Q11 against Zenering. In normal operation, Q10 to Q11 are off, and their input stage is buffered from the operational amplifier inputs by Q6 to D3 and Q8 to D4.

Operation of the input stage is best understood as a function of applied common-mode voltage: when the inputs of the AD8565/AD8566/AD8567 are biased midway between the supplies, the differential signal path gain is controlled by resistive loads Q4 to Q5 (via R9, R10). As the input common-mode level is reduced toward the negative supply (V_{NEG} or GND), the input transistor current sources, I1 and I2, are forced into saturation, thereby forcing the Q6 to D3 and Q8 to D4 networks into cutoff. However, Q4 to Q5 remain active, providing input stage gain.

Inversely, when common-mode input voltage is increased toward the positive supply, Q4 to Q5 are driven into cutoff, Q3 is driven into saturation, and Q4 becomes active, providing bias to the Q10 to Q11 differential pair. The point at which the Q10 to Q11 differential pair becomes active is approximately equal to ($V_{POS} - 1$ V).

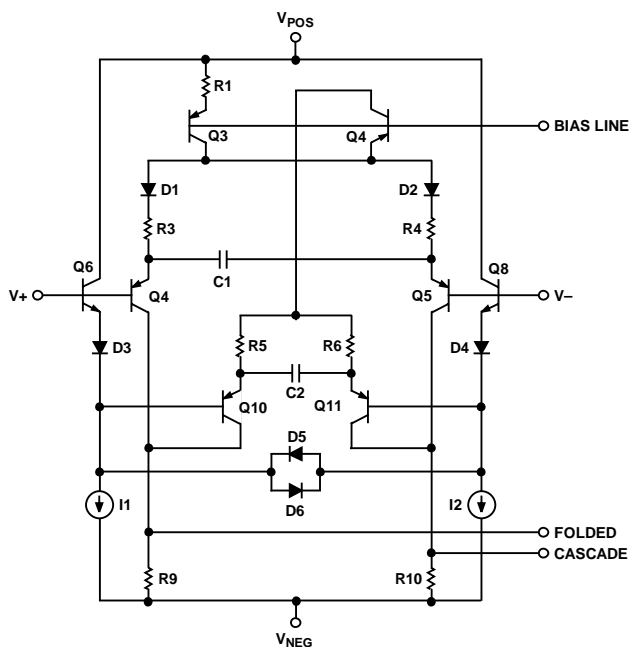

Figure 28. AD8565/AD8566/AD8567 Equivalent Input Circuit

The benefit of this type of input stage is low bias current. The input bias current is the sum of base currents of Q4 to Q5 and Q6 to Q8 over the range from ($V_{NEG} + 1$ V) to ($V_{POS} - 1$ V). Outside this range, the input bias current is dominated by the sum of base currents of Q10 to Q11 for input signals close to V_{NEG} and of Q6 to Q8 (Q10 to Q11) for signals close to V_{POS} . From this type of design, the input bias current of the AD8565/AD8566/AD8567 not only exhibits different amplitude but also exhibits different polarities. Figure 29 provides the characteristics of the input bias current vs. the common-mode voltage. It is important to keep in mind that the source impedances driving the inputs are balanced for optimum dc and ac performance.

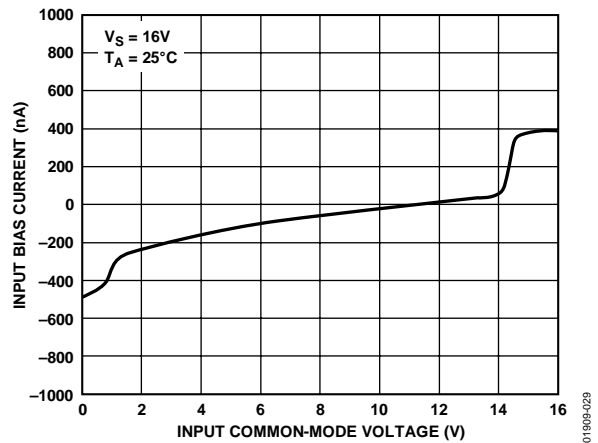

Figure 29. AD8565/AD8566/AD8567 Input Bias Current vs. Common-Mode Voltage

To achieve rail-to-rail output performance, the AD8565/AD8566/AD8567 design uses a complementary common-source (or gmRL) output. This configuration allows output voltages to approach the power supply rails, particularly if the output transistors are allowed to enter the triode region on extremes of signal swing, which are limited by V_{GS} , the transistor sizes, and output load current. In addition, this type of output stage exhibits voltage gain in an open-loop gain configuration. The amount of gain depends on the total load resistance at the output of the AD8565/AD8566/AD8567.

INPUT OVERVOLTAGE PROTECTION

As with any semiconductor device, whenever the input exceeds either supply voltages, attention needs to be paid to the input overvoltage characteristics. As an overvoltage occurs, the amplifier could be damaged, depending on the voltage level and the magnitude of the fault current. When the input voltage exceeds either supply by more than 0.6 V, internal positive-negative (pn) junctions allow current to flow from the input to the supplies.

This input current is not inherently damaging to the device as long as it is limited to 5 mA or less. If a condition exists using the AD8565/AD8566/AD8567 where the input exceeds the supply more than 0.6 V, an external series resistor must be added. The size of the resistor can be calculated by using the maximum over-voltage divided by 5 mA. This resistance must be placed in series with either input exposed to an overvoltage.

OUTPUT PHASE REVERSAL

The AD8565/AD8566/AD8567 are immune to phase reversal. Although device output does not change phase, large currents due to input overvoltage could damage the device. In applications where the possibility of an input voltage exceeding the supply voltage exists, overvoltage protection must be used as described in the Input Overvoltage Protection section.

POWER DISSIPATION

The maximum allowable internal junction temperature of 150°C limits the maximum power dissipation of AD8565/AD8566/AD8567 devices. As the ambient temperature increases, the maximum power dissipated by AD8565/AD8566/AD8567 devices must decrease linearly to maintain maximum junction temperature. If this maximum junction temperature is exceeded momentarily, the device still operates properly once the junction temperature is reduced below 150°C. If the maximum junction temperature is exceeded for an extended period, overheating could lead to permanent damage of the device.

The maximum safe junction temperature, T_{JMAX} , is 150°C. Using the following formula, the maximum power that an AD8565/AD8566/AD8567 device can safely dissipate as a function of temperature can be obtained:

$$P_{DISS} = T_{JMAX} - T_A / \theta_{JA}$$

where:

P_{DISS} is the AD8565/AD8566/AD8567 power dissipation.

T_{JMAX} is the AD8565/AD8566/AD8567 maximum allowable junction temperature (150°C).

T_A is the ambient temperature of the circuit.

θ_{JA} is the AD8565/AD8566/AD8567 package thermal resistance, junction-to-ambient.

The power dissipated by the device can be calculated as

$$P_{DISS} = (V_S - V_{OUT}) \times I_{LOAD}$$

where:

V_S is the supply voltage.

V_{OUT} is the output voltage.

I_{LOAD} is the output load current.

Figure 30 shows the maximum power dissipation vs. temperature. To achieve proper operation, use the previous equation to calculate P_{DISS} for a specific package at any given temperature or use Figure 30.

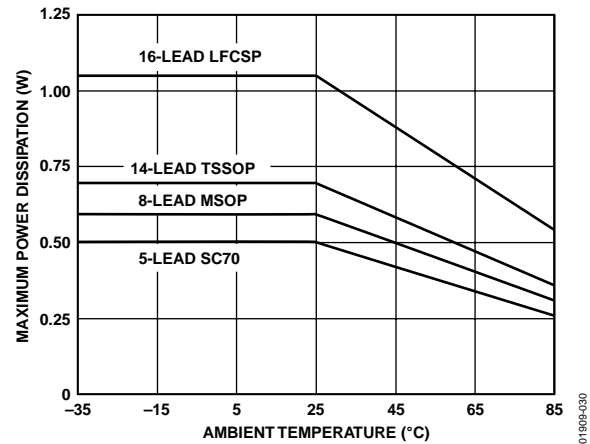

Figure 30. Maximum Power Dissipation vs. Temperature for 5-Lead SC70, 8-Lead MSOP, 14-Lead TSSOP, and 16-Lead LFCSP Packages

THERMAL PAD—AD8567

The AD8567 LFCSP comes with a thermal pad that is attached to the substrate. This substrate is connected to the most positive supply, that is, Pin 3 in the LFCSP package and Pin 4 in the TSSOP package. To be electrically safe, the thermal pad must be soldered to an area on the board that is electrically isolated or connected to V_{DD} . Attaching the thermal pad to ground adversely affects the performance of the part.

Soldering down this thermal pad dramatically improves the heat dissipation of the package. It is necessary to attach vias that connect the soldered thermal pad to another layer on the board. This provides an avenue to dissipate the heat away from the part. Without vias, the heat is isolated directly under the part.

TOTAL HARMONIC DISTORTION + NOISE (THD + N)

The AD8565/AD8566/AD8567 feature low total harmonic distortion. Figure 31 shows THD + N vs. frequency. The THD + N over the entire supply range is below 0.008%. When the device is powered from a 16 V supply, the THD + N stays below 0.003%. Figure 31 shows the AD8566 in a unity noninverting configuration.

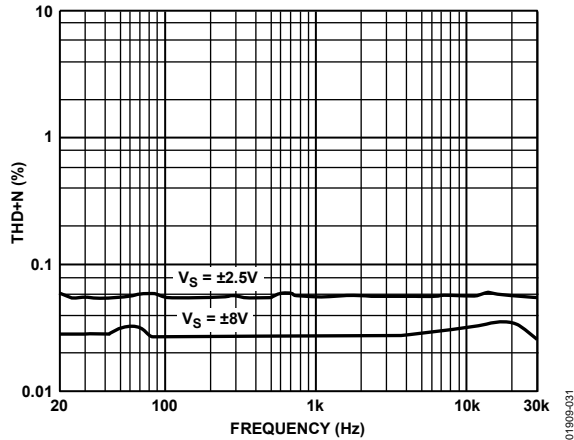

Figure 31. THD + N vs. Frequency

SHORT-CIRCUIT OUTPUT CONDITIONS

The AD8565/AD8566/AD8567 do not have internal short-circuit protection circuitry. As a precautionary measure, it is recommended not to short the output directly to the positive power supply or to ground.

It is not recommended to operate the AD8565/AD8566/AD8567 with more than 35 mA of continuous output current. The output current can be limited by placing a series resistor at the output of the amplifier whose value can be derived using

$$R_x \geq \frac{V_s}{35 \text{ mA}}$$

For a 5 V single-supply operation, R_x must have a minimum value of 143 Ω .

LCD PANEL APPLICATIONS

The AD8565/AD8566/AD8567 amplifier is designed for LCD panel applications or applications where large capacitive load drive is required. It can instantaneously source/sink greater than 250 mA of current. At unity gain, it can drive 1 μF without compensation. This makes the AD8565/AD8566/AD8567 ideal for LCD V_{COM} driver applications.

To evaluate the performance of the AD8565/AD8566/AD8567, a test circuit was developed to simulate the V_{COM} driver application for an LCD panel. Figure 32 shows the test circuit. Series capacitors and resistors connected to the output of the op amp represent the load of the LCD panel. The 300 Ω and 3 k Ω feedback resistors are used to improve settling time. This test circuit simulates the worst-case scenario for a V_{COM} . It drives a represented load that is connected to a signal switched symmetrically around V_{COM} .

Figure 33 shows a scope photo of the instantaneous output peak current capability of the AD8565/AD8566/AD8567.

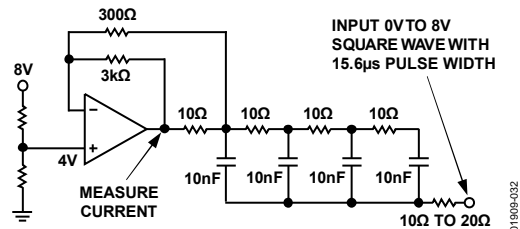

Figure 32. V_{COM} Test Circuit with Supply Voltage at 16 V

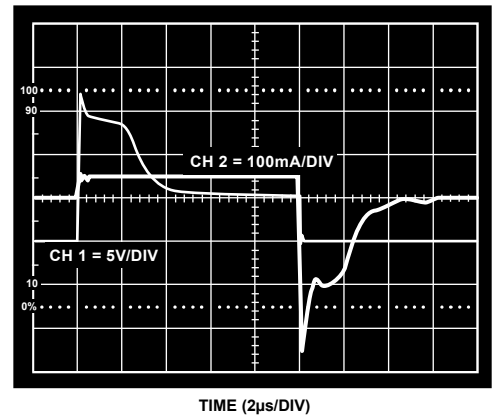
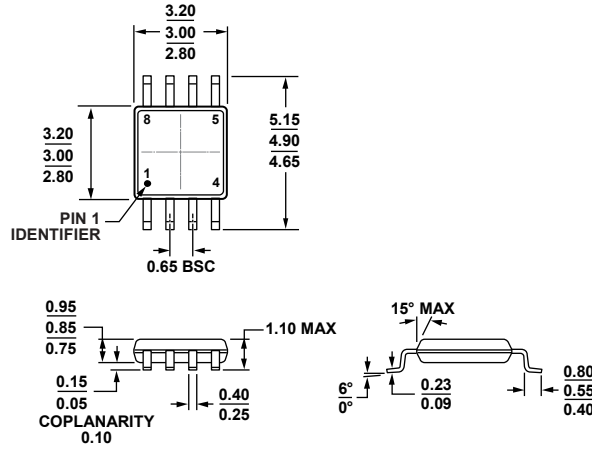

Figure 33. Scope Photo of the V_{COM} Instantaneous Peak Current

OUTLINE DIMENSIONS



COMPLIANT TO JEDEC STANDARDS MO-187-AA
 Figure 34. 8-Lead Mini Small Outline Package [MSOP]
 (RM-8)

Dimensions shown in millimeters

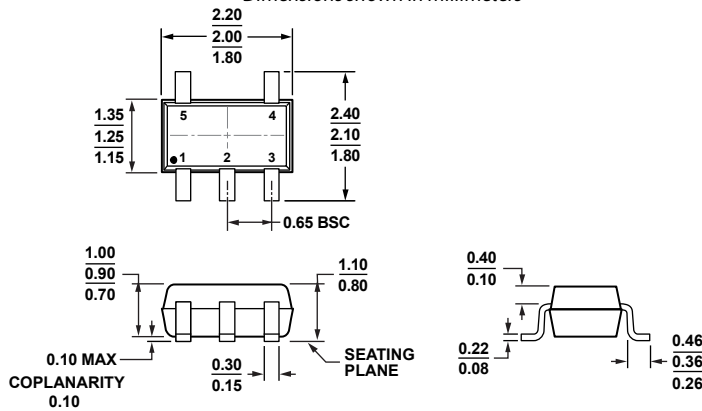

COMPLIANT TO JEDEC STANDARDS MO-203-AA
 Figure 35. 5-Lead Thin Shrink Small Outline Transistor Package [SC70]
 (KS-5)

Dimensions shown in millimeters

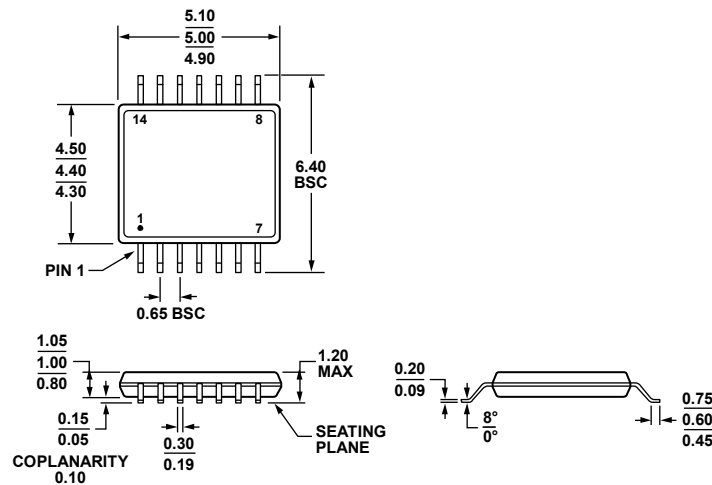

COMPLIANT TO JEDEC STANDARDS MO-153-AB-1
 Figure 36. 14-Lead Thin Shrink Small Outline Package [TSSOP]
 (RU-14)

Dimensions shown in millimeters

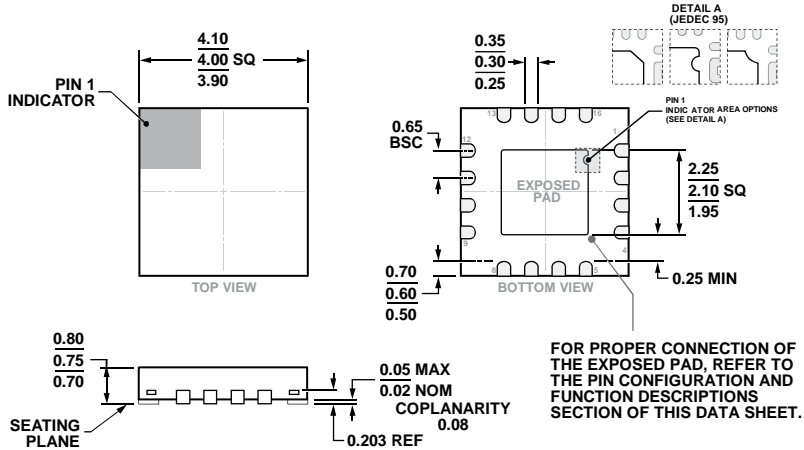

COMPLIANT TO JEDEC STANDARDS MO-220-WGGC.
 Figure 37. 16-Lead Lead Frame Chip Scale Package [LFCSP]
 4 mm x 4 mm Body and 0.75 mm Package Height
 (CP-16-23)
 Dimensions shown in millimeters

ORDERING GUIDE

Model ^{1, 2}	Absolute Maximum (V)	Temperature Range	Package Description	Package Option	Branding
AD8565AKSZ-REEL7	18	-40°C to +85°C	5-Lead SC70	KS-5	A0N
AD8566ARMZ-R2	18	-40°C to +85°C	8-Lead MSOP	RM-8	ATA#
AD8566ARMZ-REEL	18	-40°C to +85°C	8-Lead MSOP	RM-8	ATA#
AD8566WARMZ-REEL	18	-40°C to +85°C	8-Lead MSOP	RM-8	LG3
AD8567ARUZ	18	-40°C to +85°C	14-Lead TSSOP	RU-14	
AD8567ARUZ-REEL	18	-40°C to +85°C	14-Lead TSSOP	RU-14	
AD8567ACPZ-R2	18	-40°C to +85°C	16-Lead LFCSP	CP-16-23	
AD8567ACPZ-REEL	18	-40°C to +85°C	16-Lead LFCSP	CP-16-23	
AD8567ACPZ-REEL7	18	-40°C to +85°C	16-Lead LFCSP	CP-16-23	

¹ Z = RoHS Compliant Part, # denotes RoHS compliant product, may be top or bottom marked.
² Qualified for automotive applications.

Looking for pricing, stock, or lifecycle information?

Click below to explore more details on WIN SOURCE:

- ⊖ [View AD8566ARMZ-REEL on WIN SOURCE](#)
- ⊖ [Analog Devices Inc. Information](#)

Optimize Your Supply Chain with WIN SOURCE Solutions

- ✓ Global Sourcing Solution
- ✓ Obsolete Management
- ✓ Cost Control Management
- ✓ Shortage Management
- ✓ Alternative Solution
- ✓ Excess Inventory Management