

R2A20112ASP

R03DS0047EJ0201

Rev.2.01

Jan 08, 2016

Critical Conduction Mode Interleaved PFC Control IC

Description

The R2A20112A controls a boost converter to provide an active power factor correction.

The R2A20112A adopts critical conduction mode for power factor correction and realizes high efficiency and a low switching noise by zero current switching.

Interleaving function improves ripple current on input or output capacitor by 180 degrees phase shift.

Soft-star, the feedback loop short detection, two mode over-voltage-protection, over-current-protection, Over current ON/OFF timer protection for boost Diode short and slave ZCD open detection are built in the R2A20112A, and can constitute a power supply system of high reliability with few external parts.

Features

- Absolute Maximum Ratings
 - Supply voltage V_{cc} : 24 V
 - Junction temperature T_j : -40 to +150°C
- Electrical Characteristics
 - VREF output voltage V_{ref} : 5.0 V \pm 1.5%
 - UVLO operation start voltage V_{uvlh} : 10.5 V \pm 0.7 V
 - UVLO operation shutdown voltage V_{uvll} : 9.3 V \pm 0.5 V
 - UVLO hysteresis voltage H_{ysuvl} : 1.2 V \pm 0.5 V
- Functions
 - Boost converter control with critical conduction mode
 - Interleaving control
 - Soft start function for the reference voltage of Error Amp
 - Two mode PFC output Over-voltage-protection
 - Mode1: Dynamic OVP corresponding to a voltage rise by dynamic load change.
 - Mode2: Static OVP corresponding to over-voltage in stable.
 - PFC output Dynamic-under-voltage-protection (DUVP)
 - Feedback loop open/short detection
 - Master and Slave independence over-current-protection
 - 280 μ s restart timer
 - Slave ZCD signal open detection
 - Over current ON/OFF timer protection for boost Diode short
- Package
 - Pb-free SOP-16

Ordering Information

Part No.	Package Name	Package Code	Package Abbreviation	Taping Abbreviation (Quantity)
R2A20112ASPW0	FP-16DAV	PRSP0016DH-B	SP	W (2,000 pcs/reel)

Pin Arrangement

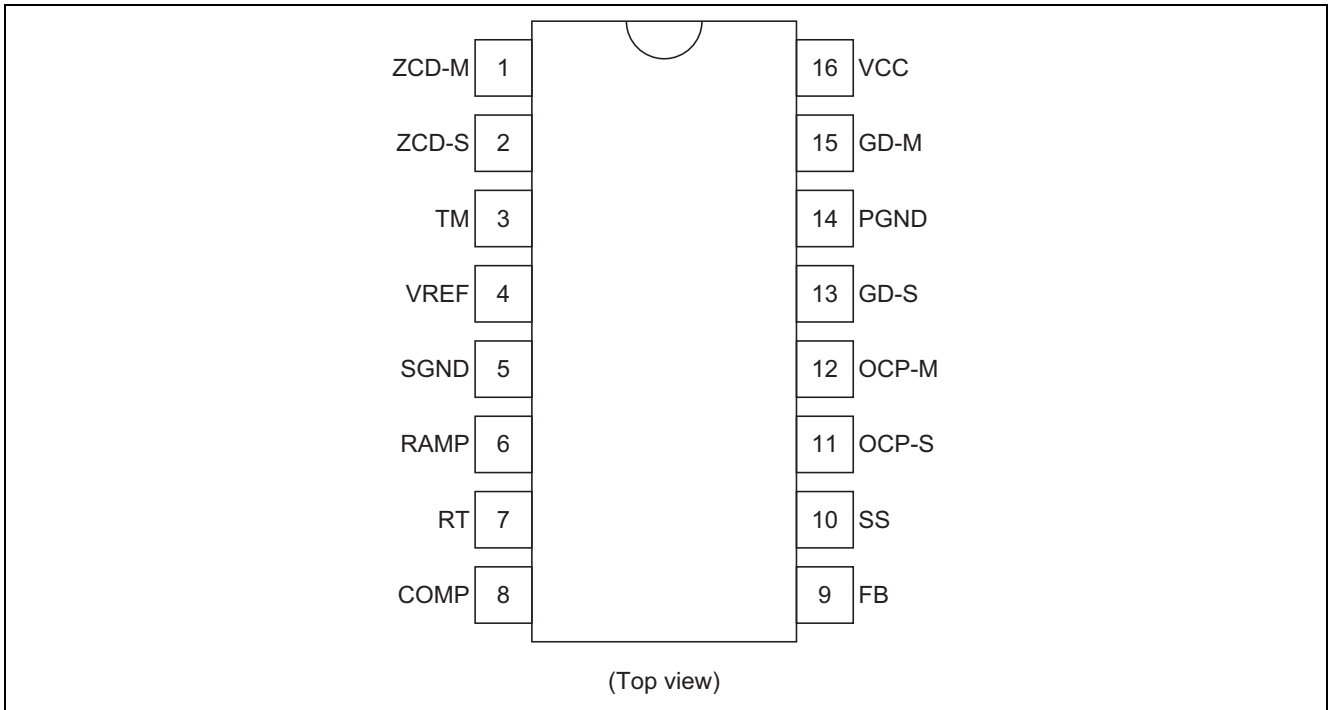

Pin Functions

Pin No.	Pin Name	Function
1	ZCD-M	Master converter zero current detection input terminal
2	ZCD-S	Slave converter zero current detection input terminal
3	TM	Over current ON/OFF timer protection terminal
4	VREF	Reference voltage output terminal
5	SGND	Signal Ground
6	RAMP	Ramp waveform setting terminal
7	RT	Oscillator frequency setting terminal
8	COMP	Error amplifier output terminal
9	FB	Error amplifier input terminal
10	SS	Soft start time setting terminal
11	OCP-S	Slave converter overcurrent detection terminal
12	OCP-M	Master converter overcurrent detection terminal
13	GD-S	Slave converter Power MOSFET drive terminal
14	PGND	Power Ground
15	GD-M	Master converter Power MOSFET drive terminal
16	VCC	Supply voltage terminal

Block Diagram

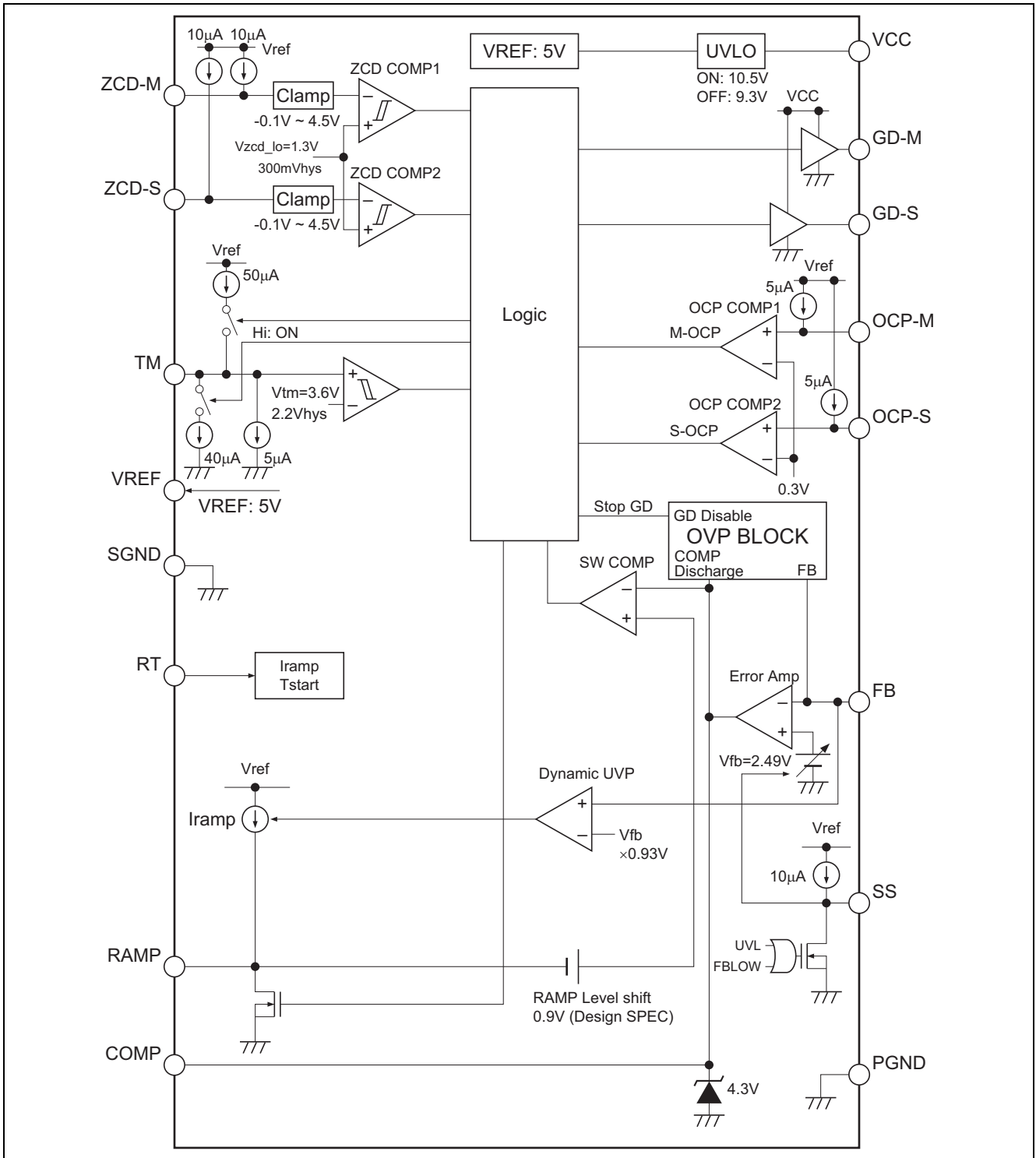

Absolute Maximum Ratings

(Ta = 25°C)

Item	Symbol	Ratings	Unit	Notes
Supply voltage	VCC	-0.3 to +24	V	
GD terminal peak current	Ipk-gd	-300 +1200	mA	3
GD terminal DC current	I _{dc-gd}	-15 +60	mA	
ZCD terminal current	I _{zcd}	+3 -3	mA	
RT terminal current	I _{rt}	-200	μA	4
Vref terminal current	I _{ref}	-5	mA	
Vref terminal load capacitor	C _{ref min}	1000	pF	
	C _{ref max}	1	μF	
COMP terminal current	I _{comp}	±1	mA	
Terminal voltage	Vt-group1	-0.3 to V _{cc}	V	5
	Vt-group2	-0.3 to V _{ref}	V	6
Vref terminal voltage	Vt-ref	-0.3 to V _{ref} + 0.3	V	
OCP terminal voltage	Vt-ocp	*-1 to V _{ref}	V	7
Power dissipation	P _t	1	W	8
Operating ambient temperature	T _{a-opr}	-40 to +125	°C	
Junction temperature	T _j	-40 to +150	°C	9
Storage temperature	T _{stg}	-55 to +150	°C	

- Notes:
- Rated voltages are with reference to the PGND terminal.
 - For rated currents, inflow to the IC is indicated by (+), and outflow by (-).
 - Shows the transient current when driving a capacitive load.
 - RT terminal's resistor is fixed 33 kΩ to GND.
 - This is the rated voltage for the following pins:
Nothing
 - This is the rated voltage for the following pins:
FB, SS, RAMP, TM
 - Minus value is peak voltage. Do not impress the DC voltage of the minus.
 - $\theta_{ja} = 120^{\circ}\text{C/W}$
This value is a thing mounting on 40 × 40 (thickness: 1.6 mm) [mm²],
a glass epoxy board of wiring density 10%.
 - Stresses exceeding the absolute maximum ratings may damage the device.
These are stress ratings only. Functional operation above the recommended operating ambient temperature range is not implied.
Extended exposure to stresses above the absolute maximum ratings may affect device reliability.

Electrical Characteristics

(Ta = 25°C, VCC = 12 V, RT = 33 kΩ, RAMP = 820 pF, TM = 2.2 μF, SS = 1.0 μF, OCP = GND)

Item		Symbol	Min	Typ	Max	Unit	Test Conditions
Supply	UVLO turn-on threshold	Vuvlh	9.8	10.5	11.2	V	
	UVLO turn-off threshold	Vuvll	8.8	9.3	9.8	V	
	UVLO hysteresis	Hysuvl	0.7	1.2	1.7	V	
	Standby current	Istby	—	85	170	μA	VCC = 8.9 V
	Operating current	Icc	—	4.2	6.3	mA	
VREF	Output voltage	Vref	4.925	5.00	5.075	V	Isource = -1 mA
	Line regulation	Vref-line	—	5	20	mV	Isource = -1 mA Vcc = 10 V to 24 V
	Load regulation	Vref-load	—	5	20	mV	Isource = -1 mA to -5 mA
	Temperature stability	dVref	—	±80	—	ppm/°C	Ta = -40 to +125°C *1
Error amplifier	Feedback voltage	Vfb	2.452	2.490	2.528	V	FB-COMP short
	Input bias current	Ifb	-0.5	-0.3	-0.1	μA	Measured pin: FB FB = 3 V *1
	Open loop gain	Av	—	60	—	dB	*1
	Upper clamp voltage	Vclamp-comp	4.2	4.3	4.4	V	FB = 2.0 V
	Low voltage	VI-comp	—	0.1	0.3	V	FB = 3.0 V
	Source current	Isrc-comp	—	-120	—	μA	FB = 1.5 V COMP = 2.5 V *1
	Sink current	Isnk-comp	—	330	—	μA	FB = 3.5 V COMP = 2.5 V
Ramp	RAMP charge current at DUVP disable condition	Ic-ramp1	-60	-50	-40	μA	FB = 2.4 V
	RAMP charge current at DUVP enable condition	Ic-ramp2	-32	-25	-18	μA	FB = 2 V
	RAMP discharge current	Id-ramp	7	15	29	mA	RAMP = 1 V
	Low voltage	VI-ramp	—	17	200	mV	Isink = 100 μA
Slave control	Phase delay	Phase	160	180	200	deg	FB = 2.5 V, COMP = 2 V
	On time ratio	Ton-ratio	0	—	5	%	*1, 2

Notes: *1 Design spec

*2

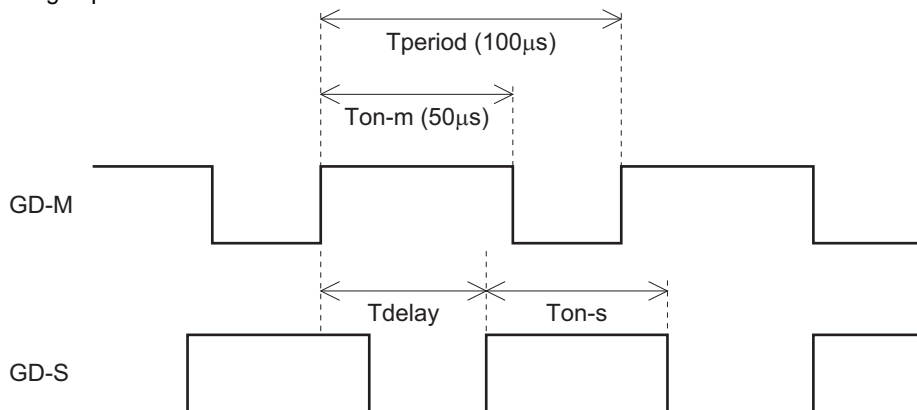

$$\text{Phase} = \frac{T_{\text{delay}}}{T_{\text{period}}} \times 360 \text{ [deg]}$$

$$\text{Ton-ratio} = \left(1 - \frac{T_{\text{on-s}}}{T_{\text{on-m}}}\right) \times 100 \text{ [%]}$$

Electrical Characteristics (cont.)

($T_a = 25^\circ\text{C}$, $V_{CC} = 12\text{ V}$, $R_T = 33\text{ k}\Omega$, $R_{AMP} = 820\text{ pF}$, $T_M = 2.2\text{ }\mu\text{F}$, $SS = 1.0\text{ }\mu\text{F}$, $OCP = GND$)

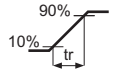
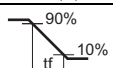
Item		Symbol	Min	Typ	Max	Unit	Test Conditions
Gate drive (GD-M & GD-S)	Gate drive rise time	tr-gd	—	20	100	ns	FB-COMP short CL = 100 pF 
	Gate drive fall time	tf-gd	—	5	30	ns	FB-COMP short CL = 100 pF 
	Gate drive low voltage	Vol1-gd	—	0.02	0.1	V	Isink = 2 mA
		Vol2-gd	—	0.01	0.2	V	Isink = 1 mA, VCC = 5 V
Gate drive high voltage	Voh-gd	11.5	11.9	—	V	Isource = -2 mA *1	
Over current protection (OCP-M & OCP-S)	OCP threshold voltage	Vocp	0.27	0.30	0.33	V	
	OCP source current	Iocp	-10	-5	-2.5	μA	OCP = 0 V
ON/OFF timer protection for Boost diode short	ON/OFF timer threshold voltage	Vtm	3.52	3.6	3.68	V	
	ON/OFF timer hysteresis	Hys-tm	2.1	2.2	2.3	V	
	Charge current	Isrc-tm	-54	-45	-36	μA	TM = 2 V, OCP-M = 1 V
	Discharge current at TM disable condition	I _{snk-tm1}	36	45	54	μA	TM = 2 V
	Discharge current at TM enable condition	I _{snk-tm2}	4.2	5	5.8	μA	TM = 5 V to 2 V
PFC output abnormality protection	Dynamic OVP threshold voltage	Vdovp	Vfb \times 1.035	Vfb \times 1.050	Vfb \times 1.065	V	COMP = 2.5 V
	Static OVP threshold voltage	Vsovp	Vfb \times 1.075	Vfb \times 1.090	Vfb \times 1.105	V	COMP = 2.5 V
	Static OVP hysteresis	Hys-sovp	50	100	150	mV	COMP = 2.5 V
	Dynamic UVP threshold voltage	Vduvp	—	Vfb \times 0.930	Vfb \times 0.950	V	COMP = 2.5 V *1
	FB low detect threshold voltage	Vfblow	0.45	0.50	0.55	V	COMP = 2.5 V
	FB low detect hysteresis	Hysfblow	0.16	0.20	0.24	V	COMP = 2.5 V
Zero current detector (ZCD-M & ZCD-S)	Upper clamp voltage	Vzcdh	4.0	4.5	5.0	V	Isource = -3 mA
	Lower clamp voltage	Vzcdl	-0.5	-0.1	0.4	V	Isink = 3 mA
	ZCD low threshold voltage	Vzcd-lo	0.9	1.3	1.6	V	*1
	ZCD hysteresis	Hyszcd	130	300	410	mV	*1
	Input bias current	Izcd	-14	-10	-6	μA	1.2 V < Vzcd < 2.5 V
ZCD-S open detector	Slave ZCD open detect delay time	tzcds	—	100	—	ms	ZCD-S: OPEN Gate drive 10 kHz *1
Soft start	Charge current	Ic-ss	-14	-10	-6	μA	SS = 3 V, FB = 1 V
Restart	Restart time delay	Tstart	210	280	350	μs	ZCD-M = 10 k Ω to GND ZCD-S = 10 k Ω to GND *2

Notes: *1 Design spec

*2

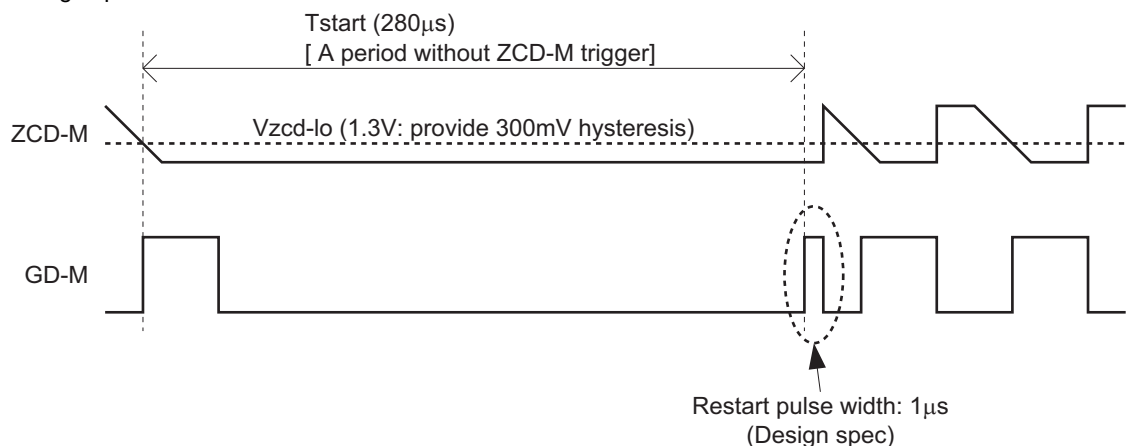

System Diagram

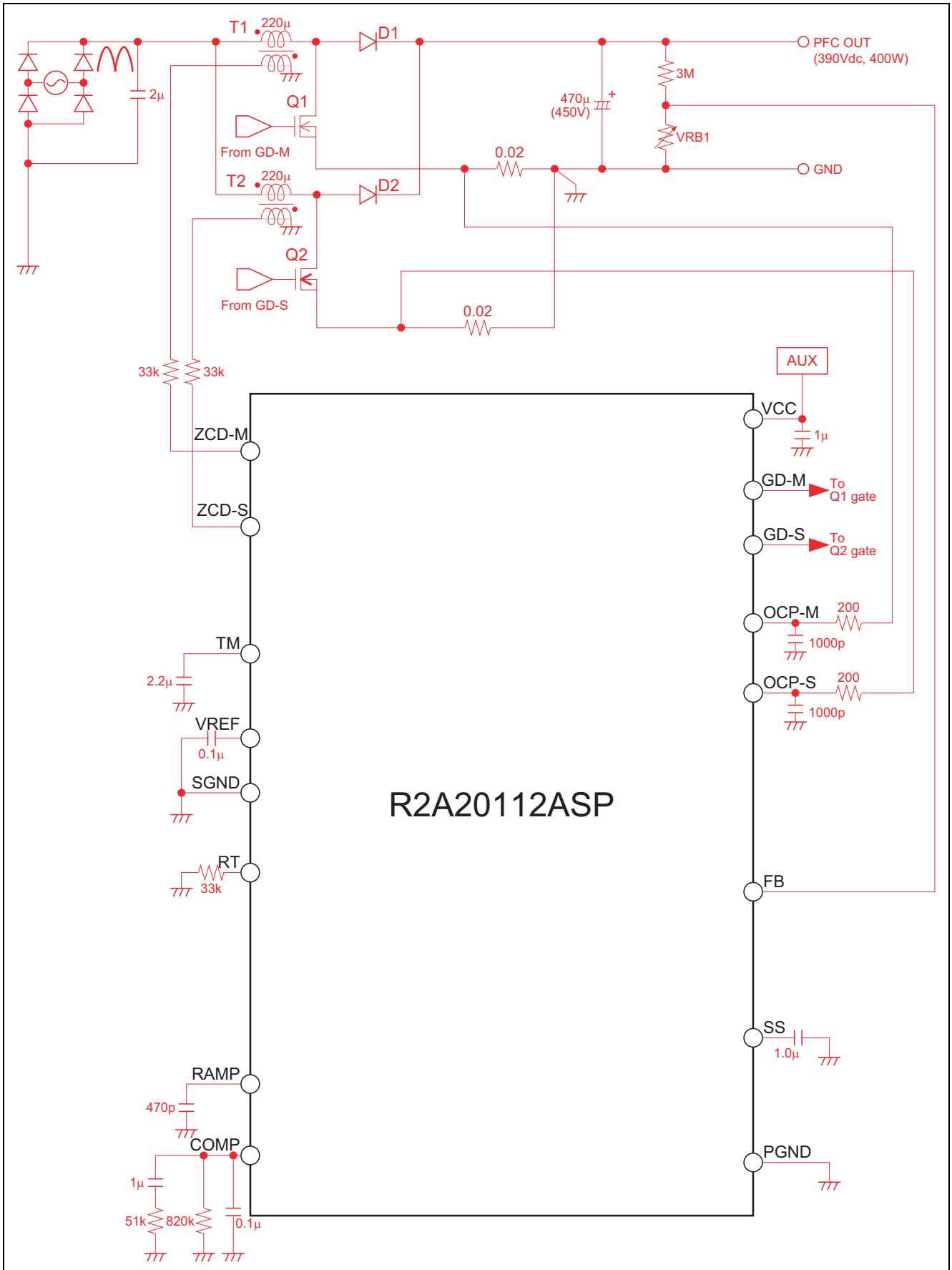

Package Dimensions

JEITA Package Code	RENESAS Code	Previous Code	MASS[Typ.]
P-SOP16-5.5x10.06-1.27	PRSP0016DH-B	FP-16DAV	0.24g

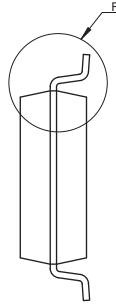
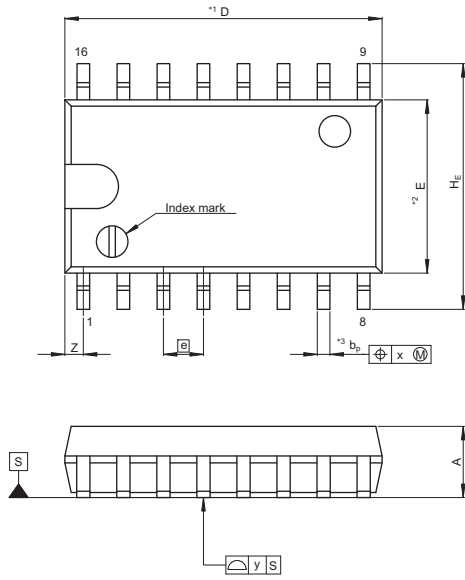

Terminal cross section
(Ni/Pd/Au plating)

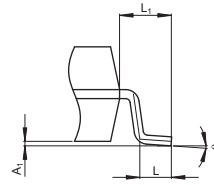
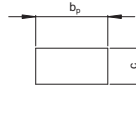

Detail F

NOTE)
1. DIMENSIONS**1 (Nom)*AND**2*
DO NOT INCLUDE MOLD FLASH.
2. DIMENSION**3*DOES NOT
INCLUDE TRIM OFFSET.

Reference Symbol	Dimension in Millimeters		
	Min	Nom	Max
D	—	10.06	10.5
E	—	5.50	—
A ₂	—	—	—
A ₁	0.00	0.10	0.20
A	—	—	2.20
b _p	0.34	0.40	0.46
b ₁	—	—	—
c	0.15	0.20	0.25
c ₁	—	—	—
θ	0°	—	8°
H _E	7.50	7.80	8.00
[e]	—	1.27	—
x	—	—	0.12
y	—	—	0.15
Z	—	—	0.80
L	0.50	0.70	0.90
L ₁	—	1.15	—

Notice

1. Descriptions of circuits, software and other related information in this document are provided only to illustrate the operation of semiconductor products and application examples. You are fully responsible for the incorporation of these circuits, software, and information in the design of your equipment. Renesas Electronics assumes no responsibility for any losses incurred by you or third parties arising from the use of these circuits, software, or information.
2. Renesas Electronics has used reasonable care in preparing the information included in this document, but Renesas Electronics does not warrant that such information is error free. Renesas Electronics assumes no liability whatsoever for any damages incurred by you resulting from errors in or omissions from the information included herein.
3. Renesas Electronics does not assume any liability for infringement of patents, copyrights, or other intellectual property rights of third parties by or arising from the use of Renesas Electronics products or technical information described in this document. No license, express, implied or otherwise, is granted hereby under any patents, copyrights or other intellectual property rights of Renesas Electronics or others.
4. You should not alter, modify, copy, or otherwise misappropriate any Renesas Electronics product, whether in whole or in part. Renesas Electronics assumes no responsibility for any losses incurred by you or third parties arising from such alteration, modification, copy or otherwise misappropriation of Renesas Electronics product.
5. Renesas Electronics products are classified according to the following two quality grades: "Standard" and "High Quality". The recommended applications for each Renesas Electronics product depends on the product's quality grade, as indicated below.
"Standard": Computers; office equipment; communications equipment; test and measurement equipment; audio and visual equipment; home electronic appliances; machine tools; personal electronic equipment; and industrial robots etc.
"High Quality": Transportation equipment (automobiles, trains, ships, etc.); traffic control systems; anti-disaster systems; anti-crime systems; and safety equipment etc.
Renesas Electronics products are neither intended nor authorized for use in products or systems that may pose a direct threat to human life or bodily injury (artificial life support devices or systems, surgical implantations etc.), or may cause serious property damages (nuclear reactor control systems, military equipment etc.). You must check the quality grade of each Renesas Electronics product before using it in a particular application. You may not use any Renesas Electronics product for any application for which it is not intended. Renesas Electronics shall not be in any way liable for any damages or losses incurred by you or third parties arising from the use of any Renesas Electronics product for which the product is not intended by Renesas Electronics.
6. You should use the Renesas Electronics products described in this document within the range specified by Renesas Electronics, especially with respect to the maximum rating, operating supply voltage range, movement power voltage range, heat radiation characteristics, installation and other product characteristics. Renesas Electronics shall have no liability for malfunctions or damages arising out of the use of Renesas Electronics products beyond such specified ranges.
7. Although Renesas Electronics endeavors to improve the quality and reliability of its products, semiconductor products have specific characteristics such as the occurrence of failure at a certain rate and malfunctions under certain use conditions. Further, Renesas Electronics products are not subject to radiation resistance design. Please be sure to implement safety measures to guard them against the possibility of physical injury, and injury or damage caused by fire in the event of the failure of a Renesas Electronics product, such as safety design for hardware and software including but not limited to redundancy, fire control and malfunction prevention, appropriate treatment for aging degradation or any other appropriate measures. Because the evaluation of microcomputer software alone is very difficult, please evaluate the safety of the final products or systems manufactured by you.
8. Please contact a Renesas Electronics sales office for details as to environmental matters such as the environmental compatibility of each Renesas Electronics product. Please use Renesas Electronics products in compliance with all applicable laws and regulations that regulate the inclusion or use of controlled substances, including without limitation, the EU RoHS Directive. Renesas Electronics assumes no liability for damages or losses occurring as a result of your noncompliance with applicable laws and regulations.
9. Renesas Electronics products and technology may not be used for or incorporated into any products or systems whose manufacture, use, or sale is prohibited under any applicable domestic or foreign laws or regulations. You should not use Renesas Electronics products or technology described in this document for any purpose relating to military applications or use by the military, including but not limited to the development of weapons of mass destruction. When exporting the Renesas Electronics products or technology described in this document, you should comply with the applicable export control laws and regulations and follow the procedures required by such laws and regulations.
10. It is the responsibility of the buyer or distributor of Renesas Electronics products, who distributes, disposes of, or otherwise places the product with a third party, to notify such third party in advance of the contents and conditions set forth in this document, Renesas Electronics assumes no responsibility for any losses incurred by you or third parties as a result of unauthorized use of Renesas Electronics products.
11. This document may not be reproduced or duplicated in any form, in whole or in part, without prior written consent of Renesas Electronics.
12. Please contact a Renesas Electronics sales office if you have any questions regarding the information contained in this document or Renesas Electronics products, or if you have any other inquiries.

(Note 1) "Renesas Electronics" as used in this document means Renesas Electronics Corporation and also includes its majority-owned subsidiaries.

(Note 2) "Renesas Electronics product(s)" means any product developed or manufactured by or for Renesas Electronics.



SALES OFFICES

Renesas Electronics Corporation

<http://www.renesas.com>

Refer to "<http://www.renesas.com/>" for the latest and detailed information.

Renesas Electronics America Inc.

2801 Scott Boulevard Santa Clara, CA 95050-2549, U.S.A.
Tel: +1-408-588-6000, Fax: +1-408-588-6130

Renesas Electronics Canada Limited

9251 Yonge Street, Suite 8309 Richmond Hill, Ontario Canada L4C 9T3
Tel: +1-905-237-2004

Renesas Electronics Europe Limited

Dukes Meadow, Millboard Road, Bourne End, Buckinghamshire, SL8 5FH, U.K.
Tel: +44-1628-585-100, Fax: +44-1628-585-900

Renesas Electronics Europe GmbH

Arcadiastrasse 10, 40472 Düsseldorf, Germany
Tel: +49-211-6503-0, Fax: +49-211-6503-1327

Renesas Electronics (China) Co., Ltd.

Room 1709, Quantum Plaza, No.27 ZhiChunLu Haidian District, Beijing 100191, P.R.China
Tel: +86-10-8235-1155, Fax: +86-10-8235-7679

Renesas Electronics (Shanghai) Co., Ltd.

Unit 301, Tower A, Central Towers, 555 Langao Road, Putuo District, Shanghai, P. R. China 200333
Tel: +86-21-2226-0888, Fax: +86-21-2226-0999

Renesas Electronics Hong Kong Limited

Unit 1601-1611, 16/F., Tower 2, Grand Century Place, 193 Prince Edward Road West, Mongkok, Kowloon, Hong Kong
Tel: +852-2265-6688, Fax: +852 2886-9022

Renesas Electronics Taiwan Co., Ltd.

13F, No. 363, Fu Shing North Road, Taipei 10543, Taiwan
Tel: +886-2-8175-9600, Fax: +886 2-8175-9670

Renesas Electronics Singapore Pte. Ltd.

80 Bendemeer Road, Unit #06-02 Hyflux Innovation Centre, Singapore 339949
Tel: +65-6213-0200, Fax: +65-6213-0300

Renesas Electronics Malaysia Sdn.Bhd.

Unit 1207, Block B, Menara Amcorp, Amcorp Trade Centre, No. 18, Jln Persiaran Barat, 46050 Petaling Jaya, Selangor Darul Ehsan, Malaysia
Tel: +60-3-7955-9390, Fax: +60-3-7955-9510

Renesas Electronics India Pvt. Ltd.



No.77C, 100 Feet Road, HAL II Stage, Indiranagar, Bangalore, India
Tel: +91-80-67208700, Fax: +91-80-67208777

Renesas Electronics Korea Co., Ltd.





12F., 234 Teheran-ro, Gangnam-Gu, Seoul, 135-080, Korea
Tel: +82-2-558-3737, Fax: +82-2-558-5141

Looking for pricing, stock, or lifecycle information?

Click below to explore more details on WIN SOURCE:

-  [View R2A20112ASP#W0 on WIN SOURCE](#)
-  [Renesas Electronics America Information](#)

Optimize Your Supply Chain with WIN SOURCE Solutions

-  Global Sourcing Solution
-  Obsolete Management
-  Cost Control Management
-  Shortage Management
-  Alternative Solution
-  Excess Inventory Management