



**THE DATASHEET OF
CDCS501PWR**



SSC Clock Generator/Buffer

FEATURES

- Part of a Family of Easy to use Clock Generator Devices With Optional SSC
- SSC Capable Clock Generator / Buffer
- SSC Controllable via 3 External Pins
 - $\pm 0\%$ to $\pm 1.5\%$ Center Spread
- 1 External Control Pin for SSC ON / OFF Selection
- 40 MHz to 108 MHz Single-Ended LVCMOS Input
- Single 3.3V Device Power Supply
- Wide Temperature Range – 40°C to 85°C
- Low Space Consumption by 8 Pin TSSOP Package

APPLICATIONS

- Consumer and Industrial Applications Requiring EMI Reduction through Spread Spectrum Clocking

PACKAGE

IN	1	8	VDD
SSC_SEL 0	2	7	SSC_SEL 2
SSC_SEL 1	3	6	OUT
GND	4	5	SSC_ON

BLOCK DIAGRAM

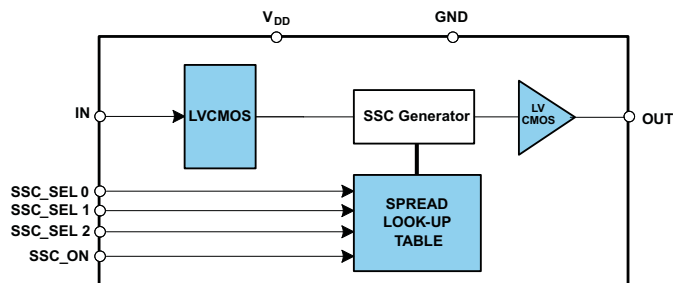

DESCRIPTION

The CDCS501 is a spread spectrum capable, LVCMOS Input Clock Buffer for EMI reduction.

The device is designed to counter common EMI problems in modern electronic designs.

It accepts a 3.3V LVCMOS signal at the input and spread this signal by a small amount, centered around the input frequency. The amount of spread can be selected via 3 control pins. The Functional Table contains detailed information on the amount of spread. A 4th control pin can be used to activate or deactivate the Spread Spectrum Clock Generator.

Selecting SSC_ON = off will turn the Spread Spectrum Clock Generator off only. The device will still pass the LVCMOS signal that's presented at its input through to its output. This pin is low active.

The wide operating frequency range covers most commonly used midrange Audio and Video frequencies. The CDCS501 operates in 3.3V environment.

It is characterized for operation from –40°C to 85°C, and available in an 8-pin TSSOP package.



Please be aware that an important notice concerning availability, standard warranty, and use in critical applications of Texas Instruments semiconductor products and disclaimers thereto appears at the end of this data sheet.



These devices have limited built-in ESD protection. The leads should be shorted together or the device placed in conductive foam during storage or handling to prevent electrostatic damage to the MOS gates.

FUNCTION TABLE

SSC_ON	SSC_SEL 0	SSC_SEL 1	SSC_SEL 2	SPREAD AMOUNT
1	x	x	X	0.00%
0	0	0	0	1.00%
0	0	0	1	1.50%
0	0	1	0	1.00%
0	0	1	1	1.50%
0	1	0	0	0.50%
0	1	0	1	0.75%
0	1	1	0	0.00%
0	1	1	1	0.50%

DEVICE INFORMATION

PACKAGE

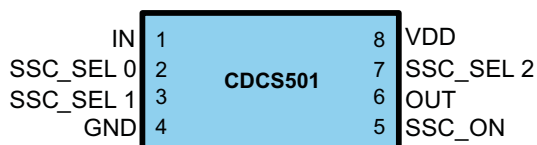

PIN FUNCTIONS

PIN			
NAME	NO.	Type	Description
IN	1	I	LVC MOS Clock Input
OUT	6	O	LVC MOS Clock Output
SSC_SEL 0, 1, 2	2, 3, 7	I	Spread Selection Pins, internal Pull-up
SSC_ON	5	I	SSC on/off Pin, active low; internal Pull-down
VDD	8	Power	3.3V Power Supply
GND	4	Ground	Ground

PACKAGE THERMAL RESISTANCE FOR TSSOP (PW) PACKAGE⁽¹⁾

CDCS501PW 8-PIN TSSOP			THERMAL AIRFLOW (CFM)				UNIT
			0	150	250	500	
R _{θJA}	High K		149	142	138	132	°C / W
	Low K		230	185	170	150	
R _{θJc}	High K	65					°C / W
	Low K	69					

(1) The package thermal impedance is calculated in accordance with JESD 51 and JEDEC2S2P (high-k board).

ABSOLUTE MAXIMUM RATINGS⁽¹⁾

over operating free-air temperature range (unless otherwise noted)

		VALUE	UNIT
V_{DD}	Supply voltage range	–0.5 to 4.6	V
V_{IN}	Input voltage range	–0.5 to 4.6	V
V_{out}	Output voltage range	–0.5 to 4.6	V
I_{IN}	Input current ($V_I < 0$, $V_I > V_{DD}$)	20	mA
I_{out}	Continuous output current	50	mA
T_{ST}	Storage temperature range	–65 to 150	°C
T_J	Maximum junction temperature	125	°C

(1) Stresses beyond those listed under *absolute maximum ratings* may cause permanent damage to the device. These are stress ratings only and functional operation of the device at these or any other conditions beyond those indicated under *recommended operating conditions* is not implied. Exposure to absolute-maximum-rated conditions for extended periods may affect device reliability.

RECOMMENDED OPERATING CONDITIONS

		MIN	NOM	MAX	UNIT
V_{DD}	Supply voltage	3.0		3.6	V
f_{IN}	Input Frequency	40		108	MHz
V_{IL}	Low level input voltage LVCMOS			0.3 V_{DD}	V
V_{IH}	High level input voltage LVCMOS	0.7 V_{DD}			V
V_I	Input Voltage threshold LVCMOS		0.5 V_{DD}		V
C_L	Output Load Test LVCMOS			15	pF
I_{OH}/I_{OL}	Output Current			12	mA
T_A	Operating free-air temperature	–40		85	°C

DEVICE CHARACTERISTICS

over recommended operating free-air temperature range (unless otherwise noted)

PARAMETER		TEST CONDITIONS	MIN	TYP	MAX	UNIT
I_{DD}	Device supply current	$f_{IN} = 80 \text{ MHz}$		26		mA
f_{OUT}	Output frequency		40		108	MHz
I_{IH}	LVC MOS input current	$V_I = V_{DD}; V_{DD} = 3.6V$			10	μA
I_{IL}	LVC MOS input current	$V_I = 0 \text{ V}; V_{DD} = 3.6V$			-10	μA
V_{OH}	LVC MOS high-level output voltage	$I_{OH} = -0.1mA$	2.9			V
		$I_{OH} = -8mA$	2.4			
		$I_{OH} = -12mA$	2.2			
V_{OL}	LVC MOS low-level output voltage	$I_{OL} = 0.1mA$			0.1	V
		$I_{OL} = 8mA$			0.5	
		$I_{OL} = 12mA$			0.8	
$t_{JIT(C-C)}$	Cycle to cycle jitter cycles	$f_{out} = 80 \text{ MHz}; SSC = 1\%, 10000 \text{ cycles}$		110		ps
t_r/t_f	Rise and fall time	20%–80%		0.75		ns
O_{dc}	Output duty cycle		45%		55%	
f_{MOD}	Modulation frequency			30		kHz

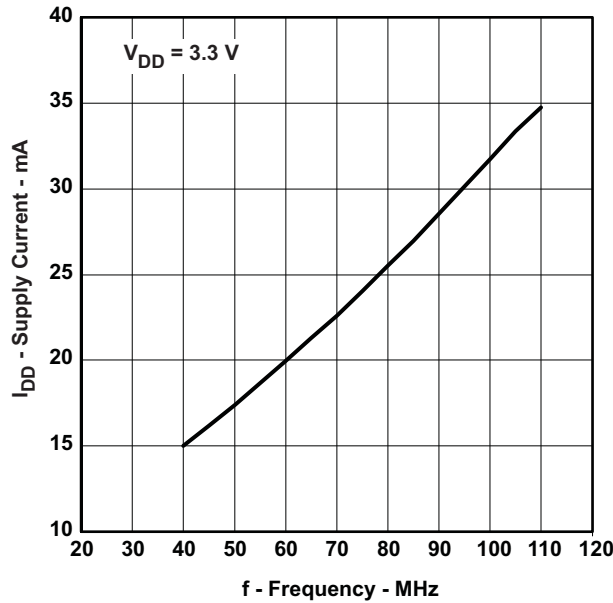

Figure 1. I_{DD} vs. Input Frequency, $V_{DD} = 3.3V$

APPLICATION INFORMATION

SSC MODULATION

The exact implementation of the SSC modulation plays a vital role for the EMI reduction. The CDCS501 uses a triangular modulation scheme implemented in a way that the modulation frequency depends on the VCO frequency of the internal PLL and the spread amount is independent from the VCO frequency.

The modulation frequency can be calculated by using the below formula.

$$f_{\text{mod}} = f_{\text{IN}} / 2480$$

PARAMETER MEASUREMENT INFORMATION

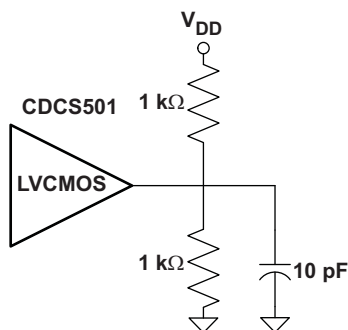

Figure 2. Test Load

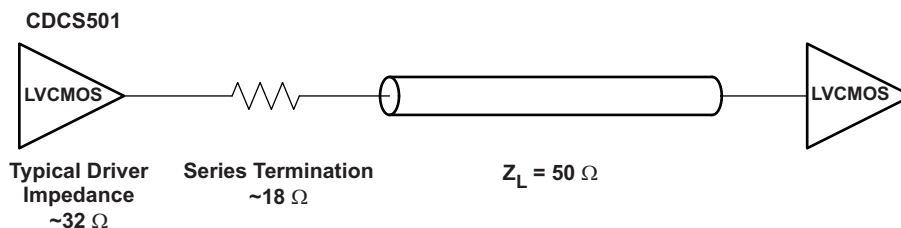

Figure 3. Test Load for 50-Ω Board Environment

PACKAGING INFORMATION

Orderable Device	Status (1)	Package Type	Package Drawing	Pins	Package Qty	Eco Plan (2)	Lead/Ball Finish (6)	MSL Peak Temp (3)	Op Temp (°C)	Device Marking (4/5)	Samples
CDCS501PW	ACTIVE	TSSOP	PW	8	150	Green (RoHS & no Sb/Br)	CU NIPDAU	Level-1-260C-UNLIM	-40 to 85	CS501	Samples
CDCS501PWR	ACTIVE	TSSOP	PW	8	2000	Green (RoHS & no Sb/Br)	CU NIPDAU	Level-1-260C-UNLIM	-40 to 85	CS501	Samples

(1) The marketing status values are defined as follows:

ACTIVE: Product device recommended for new designs.

LIFEBUY: TI has announced that the device will be discontinued, and a lifetime-buy period is in effect.

NRND: Not recommended for new designs. Device is in production to support existing customers, but TI does not recommend using this part in a new design.

PREVIEW: Device has been announced but is not in production. Samples may or may not be available.

OBsolete: TI has discontinued the production of the device.

(2) Eco Plan - The planned eco-friendly classification: Pb-Free (RoHS), Pb-Free (RoHS Exempt), or Green (RoHS & no Sb/Br) - please check <http://www.ti.com/productcontent> for the latest availability information and additional product content details.

TBD: The Pb-Free/Green conversion plan has not been defined.

Pb-Free (RoHS): TI's terms "Lead-Free" or "Pb-Free" mean semiconductor products that are compatible with the current RoHS requirements for all 6 substances, including the requirement that lead not exceed 0.1% by weight in homogeneous materials. Where designed to be soldered at high temperatures, TI Pb-Free products are suitable for use in specified lead-free processes.

Pb-Free (RoHS Exempt): This component has a RoHS exemption for either 1) lead-based flip-chip solder bumps used between the die and package, or 2) lead-based die adhesive used between the die and leadframe. The component is otherwise considered Pb-Free (RoHS compatible) as defined above.

Green (RoHS & no Sb/Br): TI defines "Green" to mean Pb-Free (RoHS compatible), and free of Bromine (Br) and Antimony (Sb) based flame retardants (Br or Sb do not exceed 0.1% by weight in homogeneous material)

(3) MSL, Peak Temp. - The Moisture Sensitivity Level rating according to the JEDEC industry standard classifications, and peak solder temperature.

(4) There may be additional marking, which relates to the logo, the lot trace code information, or the environmental category on the device.

(5) Multiple Device Markings will be inside parentheses. Only one Device Marking contained in parentheses and separated by a "~" will appear on a device. If a line is indented then it is a continuation of the previous line and the two combined represent the entire Device Marking for that device.

(6) Lead/Ball Finish - Orderable Devices may have multiple material finish options. Finish options are separated by a vertical ruled line. Lead/Ball Finish values may wrap to two lines if the finish value exceeds the maximum column width.

Important Information and Disclaimer: The information provided on this page represents TI's knowledge and belief as of the date that it is provided. TI bases its knowledge and belief on information provided by third parties, and makes no representation or warranty as to the accuracy of such information. Efforts are underway to better integrate information from third parties. TI has taken and continues to take reasonable steps to provide representative and accurate information but may not have conducted destructive testing or chemical analysis on incoming materials and chemicals. TI and TI suppliers consider certain information to be proprietary, and thus CAS numbers and other limited information may not be available for release.

In no event shall TI's liability arising out of such information exceed the total purchase price of the TI part(s) at issue in this document sold by TI to Customer on an annual basis.

TAPE AND REEL INFORMATION



QUADRANT ASSIGNMENTS FOR PIN 1 ORIENTATION IN TAPE



*All dimensions are nominal

Device	Package Type	Package Drawing	Pins	SPQ	Reel Diameter (mm)	Reel Width W1 (mm)	A0 (mm)	B0 (mm)	K0 (mm)	P1 (mm)	W (mm)	Pin1 Quadrant
CDCS501PWR	TSSOP	PW	8	2000	330.0	12.4	7.0	3.6	1.6	8.0	12.0	Q1

TAPE AND REEL BOX DIMENSIONS



*All dimensions are nominal

Device	Package Type	Package Drawing	Pins	SPQ	Length (mm)	Width (mm)	Height (mm)
CDCS501PWR	TSSOP	PW	8	2000	367.0	367.0	35.0

PW0008A



PACKAGE OUTLINE

TSSOP - 1.2 mm max height

SMALL OUTLINE PACKAGE

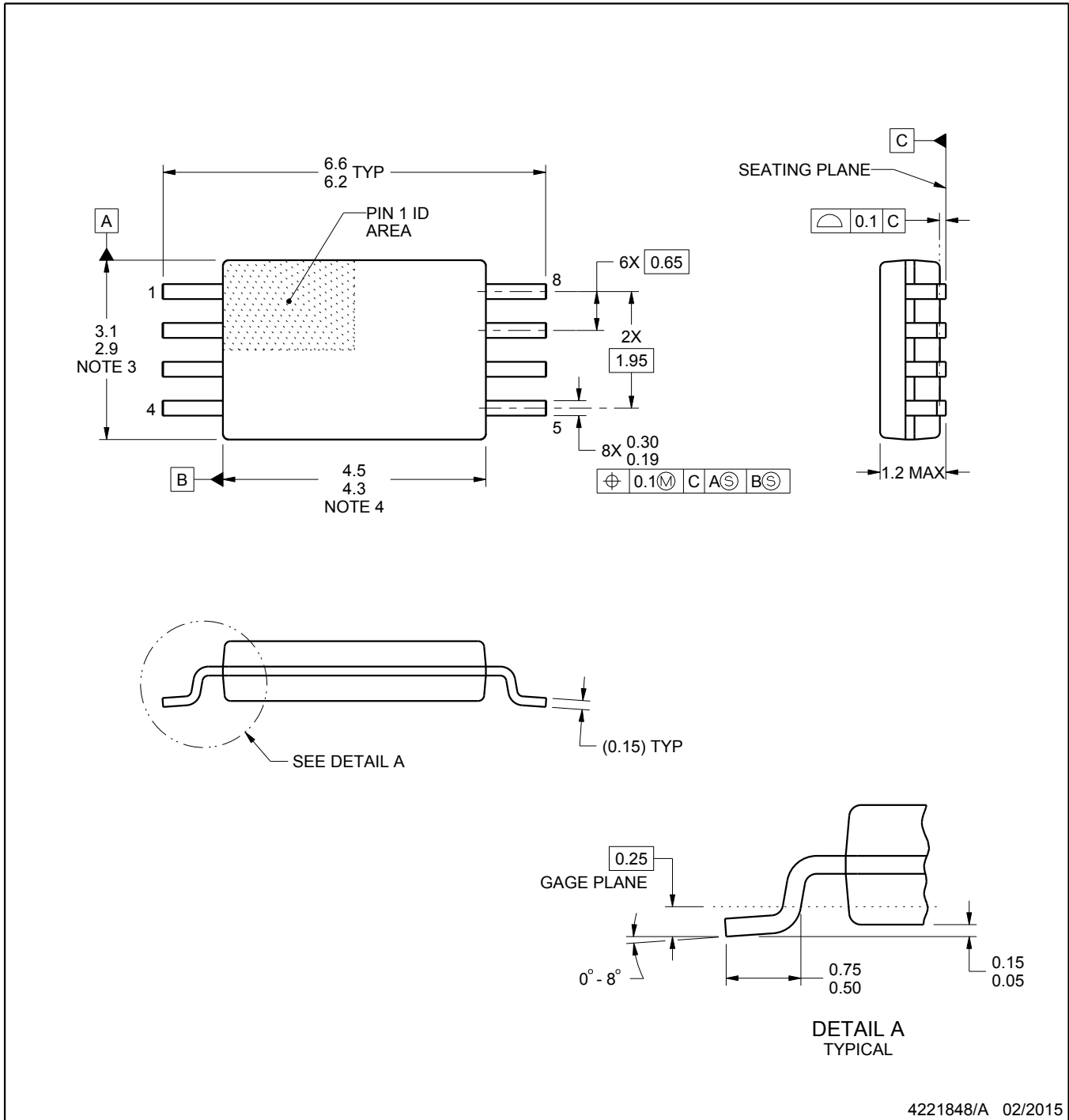

4221848/A 02/2015

NOTES:

1. All linear dimensions are in millimeters. Any dimensions in parenthesis are for reference only. Dimensioning and tolerancing per ASME Y14.5M.
2. This drawing is subject to change without notice.
3. This dimension does not include mold flash, protrusions, or gate burrs. Mold flash, protrusions, or gate burrs shall not exceed 0.15 mm per side.
4. This dimension does not include interlead flash. Interlead flash shall not exceed 0.25 mm per side.
5. Reference JEDEC registration MO-153, variation AA.

EXAMPLE BOARD LAYOUT

PW0008A

TSSOP - 1.2 mm max height

SMALL OUTLINE PACKAGE

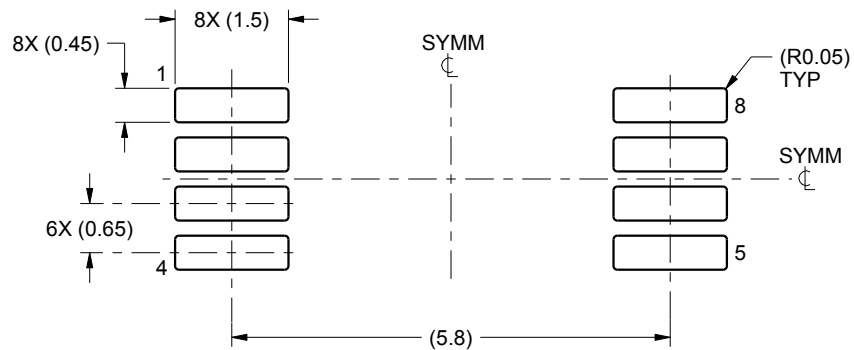

LAND PATTERN EXAMPLE
SCALE:10X

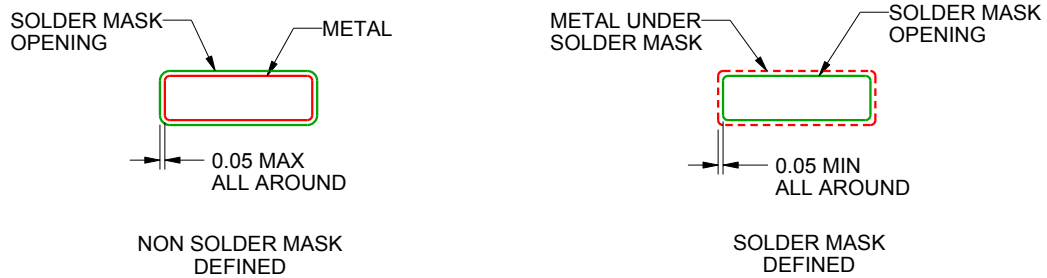

SOLDER MASK DETAILS
NOT TO SCALE

4221848/A 02/2015

NOTES: (continued)

- 6. Publication IPC-7351 may have alternate designs.
- 7. Solder mask tolerances between and around signal pads can vary based on board fabrication site.

EXAMPLE STENCIL DESIGN

PW0008A

TSSOP - 1.2 mm max height

SMALL OUTLINE PACKAGE

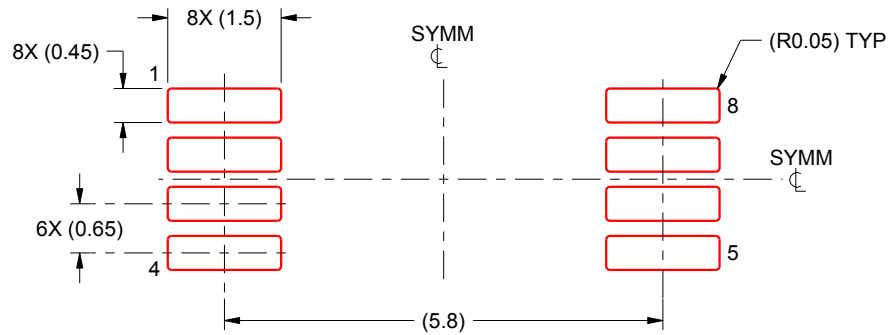

SOLDER PASTE EXAMPLE
BASED ON 0.125 mm THICK STENCIL
SCALE:10X

4221848/A 02/2015

NOTES: (continued)

8. Laser cutting apertures with trapezoidal walls and rounded corners may offer better paste release. IPC-7525 may have alternate design recommendations.
9. Board assembly site may have different recommendations for stencil design.

IMPORTANT NOTICE

Texas Instruments Incorporated and its subsidiaries (TI) reserve the right to make corrections, enhancements, improvements and other changes to its semiconductor products and services per JESD46, latest issue, and to discontinue any product or service per JESD48, latest issue. Buyers should obtain the latest relevant information before placing orders and should verify that such information is current and complete. All semiconductor products (also referred to herein as "components") are sold subject to TI's terms and conditions of sale supplied at the time of order acknowledgment.

TI warrants performance of its components to the specifications applicable at the time of sale, in accordance with the warranty in TI's terms and conditions of sale of semiconductor products. Testing and other quality control techniques are used to the extent TI deems necessary to support this warranty. Except where mandated by applicable law, testing of all parameters of each component is not necessarily performed.

TI assumes no liability for applications assistance or the design of Buyers' products. Buyers are responsible for their products and applications using TI components. To minimize the risks associated with Buyers' products and applications, Buyers should provide adequate design and operating safeguards.

TI does not warrant or represent that any license, either express or implied, is granted under any patent right, copyright, mask work right, or other intellectual property right relating to any combination, machine, or process in which TI components or services are used. Information published by TI regarding third-party products or services does not constitute a license to use such products or services or a warranty or endorsement thereof. Use of such information may require a license from a third party under the patents or other intellectual property of the third party, or a license from TI under the patents or other intellectual property of TI.

Reproduction of significant portions of TI information in TI data books or data sheets is permissible only if reproduction is without alteration and is accompanied by all associated warranties, conditions, limitations, and notices. TI is not responsible or liable for such altered documentation. Information of third parties may be subject to additional restrictions.

Resale of TI components or services with statements different from or beyond the parameters stated by TI for that component or service voids all express and any implied warranties for the associated TI component or service and is an unfair and deceptive business practice. TI is not responsible or liable for any such statements.

Buyer acknowledges and agrees that it is solely responsible for compliance with all legal, regulatory and safety-related requirements concerning its products, and any use of TI components in its applications, notwithstanding any applications-related information or support that may be provided by TI. Buyer represents and agrees that it has all the necessary expertise to create and implement safeguards which anticipate dangerous consequences of failures, monitor failures and their consequences, lessen the likelihood of failures that might cause harm and take appropriate remedial actions. Buyer will fully indemnify TI and its representatives against any damages arising out of the use of any TI components in safety-critical applications.

In some cases, TI components may be promoted specifically to facilitate safety-related applications. With such components, TI's goal is to help enable customers to design and create their own end-product solutions that meet applicable functional safety standards and requirements. Nonetheless, such components are subject to these terms.

No TI components are authorized for use in FDA Class III (or similar life-critical medical equipment) unless authorized officers of the parties have executed a special agreement specifically governing such use.

Only those TI components which TI has specifically designated as military grade or "enhanced plastic" are designed and intended for use in military/aerospace applications or environments. Buyer acknowledges and agrees that any military or aerospace use of TI components which have **not** been so designated is solely at the Buyer's risk, and that Buyer is solely responsible for compliance with all legal and regulatory requirements in connection with such use.

TI has specifically designated certain components as meeting ISO/TS16949 requirements, mainly for automotive use. In any case of use of non-designated products, TI will not be responsible for any failure to meet ISO/TS16949.

Products

Audio	www.ti.com/audio
Amplifiers	amplifier.ti.com
Data Converters	dataconverter.ti.com
DLP® Products	www.dlp.com
DSP	dsp.ti.com
Clocks and Timers	www.ti.com/clocks
Interface	interface.ti.com
Logic	logic.ti.com
Power Mgmt	power.ti.com
Microcontrollers	microcontroller.ti.com
RFID	www.ti-rfid.com
OMAP Applications Processors	www.ti.com/omap
Wireless Connectivity	www.ti.com/wirelessconnectivity

Applications

Automotive and Transportation	www.ti.com/automotive
Communications and Telecom	www.ti.com/communications
Computers and Peripherals	www.ti.com/computers
Consumer Electronics	www.ti.com/consumer-apps
Energy and Lighting	www.ti.com/energy
Industrial	www.ti.com/industrial
Medical	www.ti.com/medical
Security	www.ti.com/security
Space, Avionics and Defense	www.ti.com/space-avionics-defense
Video and Imaging	www.ti.com/video

TI E2E Community

e2e.ti.com

Looking for pricing, stock, or lifecycle information?

Click below to explore more details on WIN SOURCE:

 [View CDCS501PWR on WIN SOURCE](#)

 [Texas Instruments](#) Information

Optimize Your Supply Chain with WIN SOURCE Solutions

-  Global Sourcing Solution
-  Obsolete Management
-  Cost Control Management
-  Shortage Management
-  Alternative Solution
-  Excess Inventory Management