



**THE DATASHEET OF  
LMV1032URX-15/NOPB**



## LMV1032-06/LMV1032-15/LMV1032-25 Amplifiers for 3-Wire Analog Electret Microphones

Check for Samples: [LMV1032](#)

### FEATURES

- (Typical LMV1032-15, 1.7V Supply; Unless Otherwise Noted)
- Output Voltage Noise (A-weighted) –89 dBV
- Low Supply Current 60  $\mu$ A
- Supply Voltage 1.7V to 5V
- PSRR 70 dB
- Signal to Noise Ratio 61 dB
- Input Capacitance 2 pF
- Input Impedance >100 M $\Omega$
- Output Impedance <200 $\Omega$
- Max Input Signal 170 mV<sub>PP</sub>
- Temperature Range –40°C to 85°C
- Large Dome 4-Bump DSBGA Package with Improved Adhesion Technology.

### APPLICATIONS

- Mobile Communications - Bluetooth
- Automotive Accessories
- Cellular Phones
- PDAs
- Accessory Microphone Products

### Block Diagram

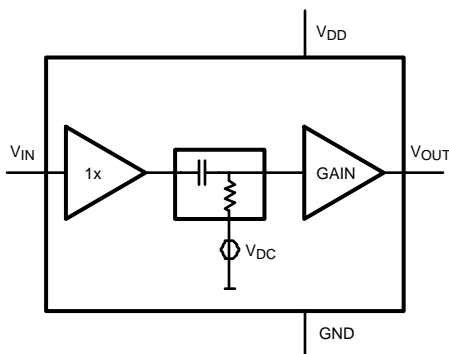

### DESCRIPTION

The LMV1032s are an audio amplifier series for small form factor electret microphones. They are designed to replace the JFET preamp currently being used. The LMV1032 series is ideal for extended battery life applications, such as a Bluetooth communication link. The addition of a third pin to an electret microphone that incorporates an LMV1032 allows for a dramatic reduction in supply current as compared to the JFET equipped electret microphone. Microphone supply current is thus reduced to 60  $\mu$ A, assuring longer battery life. The LMV1032 series is specified for supply voltages from 1.7V to 5V, and has fixed voltage gains of 6 dB, 15 dB and 25 dB.

The LMV1032 series offers low output impedance over the voice bandwidth, excellent power supply rejection (PSRR), and stability over temperature.

The devices are offered in space saving 4-bump ultra thin DSBGA lead free packages and are thus ideally suited for the form factor of miniature electret microphone packages. These extremely miniature packages have the Large Dome Bump (LDB) technology. This DSBGA technology is designed for microphone PCBs requiring 1 kg adhesion criteria.

### Electret Microphone

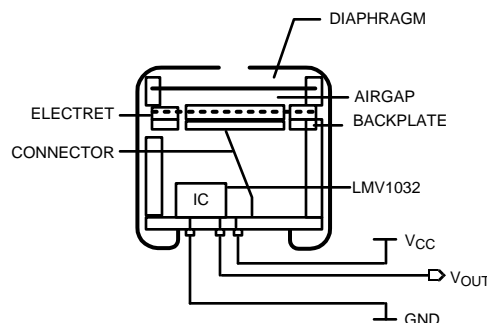

These devices have limited built-in ESD protection. The leads should be shorted together or the device placed in conductive foam during storage or handling to prevent electrostatic damage to the MOS gates.



Please be aware that an important notice concerning availability, standard warranty, and use in critical applications of Texas Instruments semiconductor products and disclaimers thereto appears at the end of this data sheet.

All trademarks are the property of their respective owners.

### Absolute Maximum Ratings<sup>(1)(2)</sup>

ESD Tolerance <sup>(3)</sup>	Human Body Model	2500V
	Machine Model	250V
Supply Voltage	V <sub>DD</sub> - GND	5.5V
Storage Temperature Range		-65°C to 150°C
Junction Temperature <sup>(4)</sup>		150°C max
Mounting Temperature	Infrared or Convection (20 sec.)	235°C

- (1) Absolute Maximum Ratings indicate limits beyond which damage to the device may occur. Operating Ratings indicate conditions for which the device is intended to be functional, but specific performance is not ensured. For ensured specifications and the test conditions, see the Electrical Characteristics.
- (2) If Military/Aerospace specified devices are required, please contact the Texas Instruments Sales Office/ Distributors for availability and specifications.
- (3) The Human Body Model (HBM) is 1.5 kΩ in series with 100 pF. The Machine Model is 0Ω in series with 200 pF.
- (4) The maximum power dissipation is a function of T<sub>J(MAX)</sub>, θ<sub>JA</sub> and T<sub>A</sub>. The maximum allowable power dissipation at any ambient temperature is P<sub>D</sub> = (T<sub>J(MAX)</sub> - T<sub>A</sub>)/θ<sub>JA</sub>. All numbers apply for packages soldered directly onto a PC board.

### Operating Ratings<sup>(1)</sup>

Supply Voltage	1.7V to 5V
Temperature Range	-40°C to +85°C

- (1) Absolute Maximum Ratings indicate limits beyond which damage to the device may occur. Operating Ratings indicate conditions for which the device is intended to be functional, but specific performance is not ensured. For ensured specifications and the test conditions, see the Electrical Characteristics.

### 1.7V and 5V Electrical Characteristics<sup>(1)</sup>

Unless otherwise specified, all limits ensured for T<sub>J</sub> = 25°C and V<sub>DD</sub> = 1.7V and 5V. **Boldface** limits apply at the temperature extremes.

Symbol	Parameter	Conditions	Min <sup>(2)</sup>	Typ <sup>(3)</sup>	Max <sup>(2)</sup>	Units
I <sub>DD</sub>	Supply Current	V <sub>IN</sub> = GND		60	<b>85</b> <b>100</b>	μA
SNR	Signal to Noise Ratio	V <sub>DD</sub> = 1.7V V <sub>IN</sub> = 18 mV <sub>PP</sub> f = 1 kHz	LMV1032-06	58		dB
			LMV1032-15	61		
			LMV1032-25	61		
		V <sub>DD</sub> = 5V V <sub>IN</sub> = 18 mV <sub>PP</sub> f = 1 kHz	LMV1032-06	59		
			LMV1036-15	61		
			LMV1032-25	62		
PSRR	Power Supply Rejection Ratio	1.7V < V <sub>DD</sub> < 5V	LMV1032-06	<b>65</b> <b>60</b>	75	dB
			LMV1032-15	<b>60</b> <b>55</b>	70	
			LMV1032-25	<b>55</b> <b>50</b>	65	
V <sub>IN</sub>	Max Input Signal	f = 1 kHz and THD+N < 1%	LMV1032-06	300		mV <sub>PP</sub>
			LMV1032-15	170		
			LMV1032-25	60		
f <sub>LOW</sub>	Lower -3 dB Roll Off Frequency	R <sub>SOURCE</sub> = 50Ω V <sub>IN</sub> = 18 mV <sub>PP</sub>		70		Hz
f <sub>HIGH</sub>	Upper -3 dB Roll Off Frequency	R <sub>SOURCE</sub> = 50Ω V <sub>IN</sub> = 18 mV <sub>PP</sub>	LMV1032-06	120		kHz
			LMV1032-15	75		
			LMV1032-25	21		

- (1) Electrical Table values apply only for factory testing conditions at the temperature indicated. Factory testing conditions result in very limited self-heating of the device such that T<sub>J</sub> = T<sub>A</sub>. No specification of parametric performance is indicated in the electrical tables under conditions of internal self-heating where T<sub>J</sub> > T<sub>A</sub>.
- (2) All limits are specified by design or statistical analysis.
- (3) Typical values represent the most likely parametric norm.

### 1.7V and 5V Electrical Characteristics<sup>(1)</sup> (continued)

Unless otherwise specified, all limits ensured for  $T_J = 25^\circ\text{C}$  and  $V_{DD} = 1.7\text{V}$  and  $5\text{V}$ . **Boldface** limits apply at the temperature extremes.

Symbol	Parameter	Conditions		Min <sup>(2)</sup>	Typ <sup>(3)</sup>	Max <sup>(2)</sup>	Units
$e_n$	Output Noise	A-Weighted	LMV1032-06		-97		dBV
			LMV1032-15		-89		
			LMV1032-25		-80		
$V_{OUT}$	Output Voltage	$V_{IN} = \text{GND}$	LMV1032-06	<b>100</b>	300	<b>500</b>	mV
			LMV1032-15	<b>250</b>	500	<b>750</b>	
			LMV1032-25	<b>300</b>	600	<b>1000</b>	
$R_O$	Output Impedance	$f = 1 \text{ kHz}$			<200		$\Omega$
$I_O$	Output Current	$V_{DD} = 1.7\text{V}, V_{OUT} = 1.7\text{V}, \text{Sinking}$		0.9 <b>0.5</b>	2.3		mA
		$V_{DD} = 1.7\text{V}, V_{OUT} = 0\text{V}, \text{Sourcing}$		0.3 <b>0.2</b>	0.64		
		$V_{DD} = 5\text{V}, V_{OUT} = 1.7\text{V}, \text{Sinking}$		0.9 <b>0.5</b>	2.4		
		$V_{DD} = 5\text{V}, V_{OUT} = 0\text{V}, \text{Sourcing}$		0.4 <b>0.1</b>	1.46		
THD	Total Harmonic Distortion	$f = 1 \text{ kHz}$ $V_{IN} = 18 \text{ mV}_{PP}$	LMV1032-06		0.11		%
			LMV1032-15		0.13		
			LMV1032-25		0.35		
$C_{IN}$	Input Capacitance				2		pF
$Z_{IN}$	Input Impedance				>100		M $\Omega$
$A_V$	Gain	$f = 1 \text{ kHz}$ $V_{IN} = 18 \text{ mV}_{PP}$	LMV1032-06	5.5 <b>4.5</b>	6.2	6.7 <b>7.7</b>	dB
			LMV1032-15	14.8 <b>14</b>	15.4	16 <b>17</b>	
			LMV1032-25	24.8 <b>24</b>	25.5	26.2 <b>27</b>	

### Connection Diagram

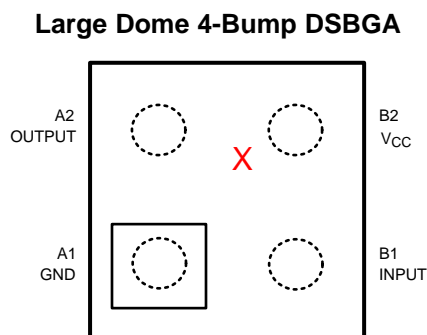

Figure 1. Top View

**Note:**

- Pin numbers are referenced to package marking text orientation.
- The actual physical placement of the package marking will vary slightly from part to part. The package will designate the date code and will vary considerably. Package marking does not correlate to device type in any way.

### Typical Performance Characteristics

Unless otherwise specified,  $V_S = 1.7V$ , single supply,  $T_A = 25^\circ C$

Supply Current vs. Supply Voltage (LMV1032-06)

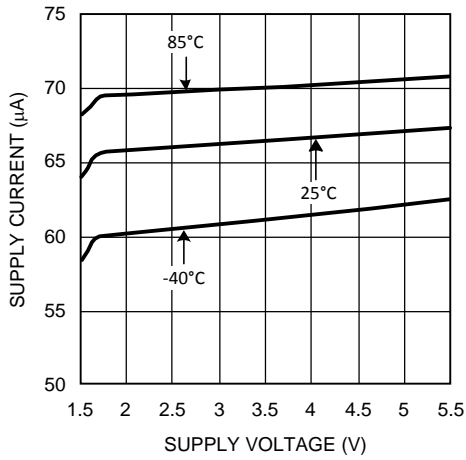

Figure 2.

Supply Current vs. Supply Voltage (LMV1032-15)

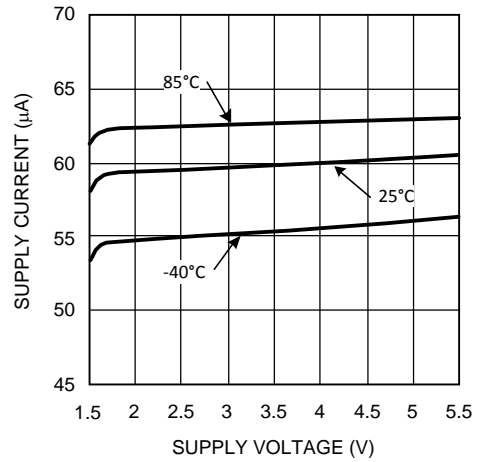

Figure 3.

Supply Current vs. Supply Voltage (LMV1032-25)

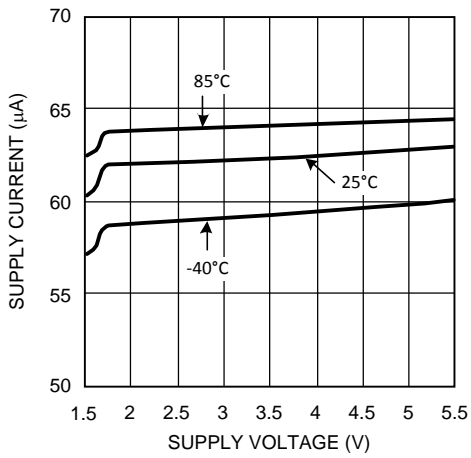

Figure 4.

Closed Loop Gain and Phase vs. Frequency (LMV1032-06)

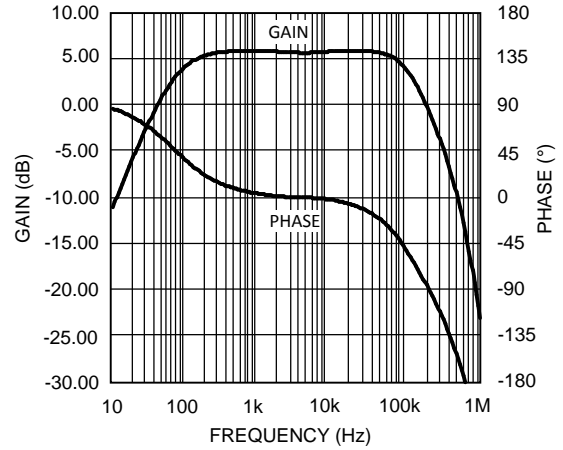

Figure 5.

Closed Loop Gain and Phase vs. Frequency (LMV1032-15)

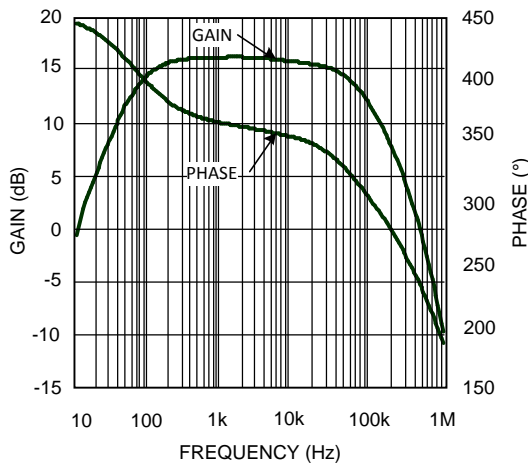

Figure 6.

Closed Loop Gain and Phase vs. Frequency (LMV1032-25)

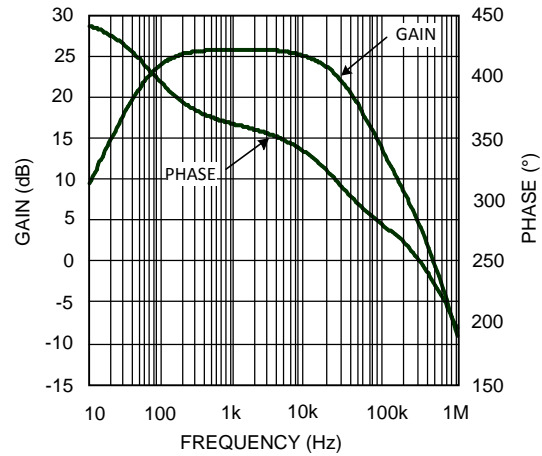

Figure 7.

Typical Performance Characteristics (continued)

Unless otherwise specified,  $V_S = 1.7V$ , single supply,  $T_A = 25^\circ C$

Power Supply Rejection Ratio vs. Frequency (LMV1032-06)

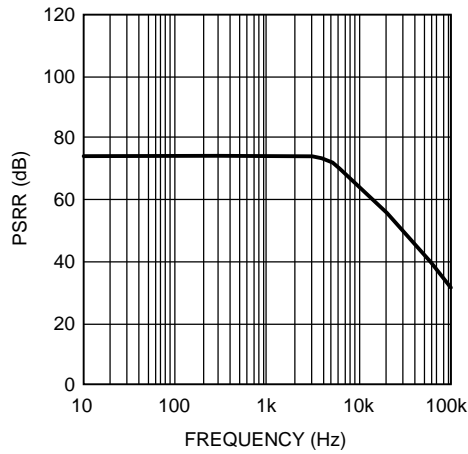

Figure 8.

Power Supply Rejection Ratio vs. Frequency (LMV1032-15)

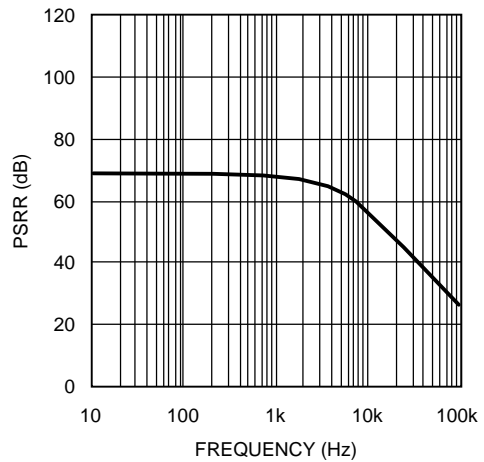

Figure 9.

Power Supply Rejection Ratio vs. Frequency (LMV1032-25)

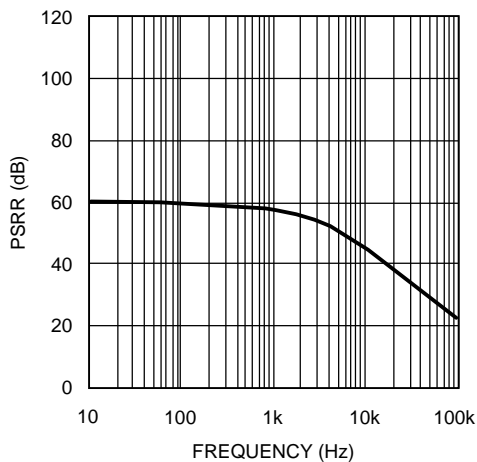

Figure 10.

Total Harmonic Distortion vs. Frequency (LMV1032-06)

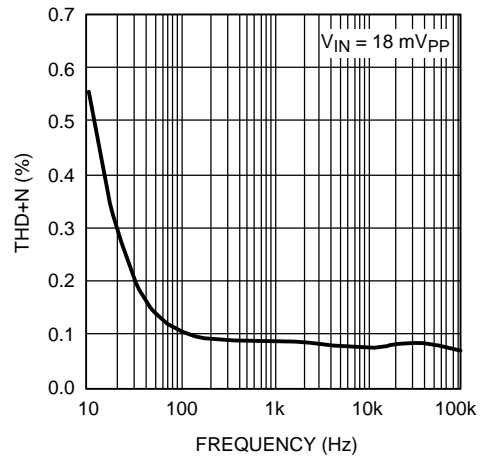

Figure 11.

Total Harmonic Distortion vs. Frequency (LMV1032-15)

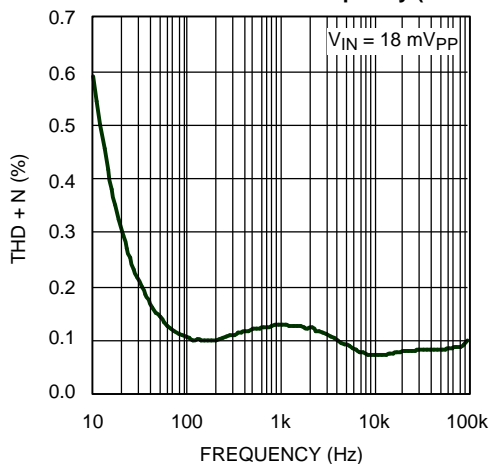

Figure 12.

Total Harmonic Distortion vs. Frequency (LMV1032-25)

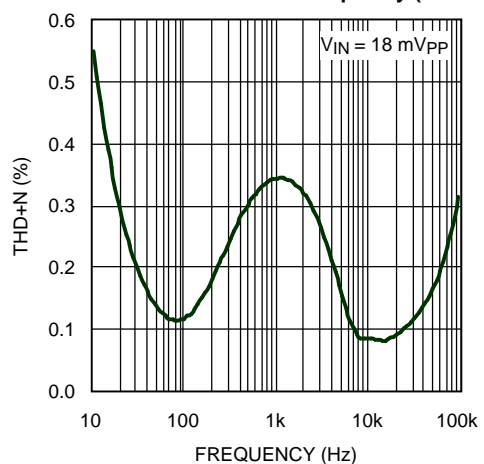

Figure 13.

**Typical Performance Characteristics (continued)**

Unless otherwise specified,  $V_S = 1.7V$ , single supply,  $T_A = 25^\circ C$

**Total Harmonic Distortion vs. Input Voltage (LMV1032-06)**

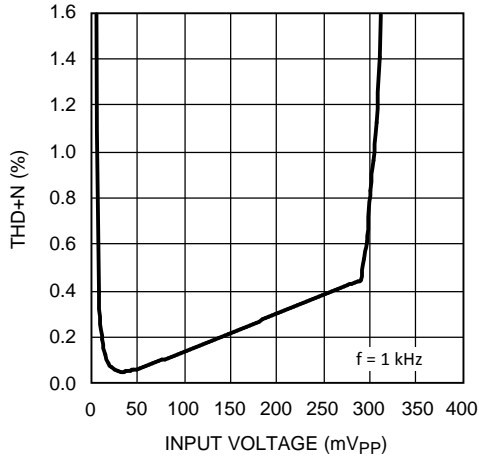

Figure 14.

**Total Harmonic Distortion vs. Input Voltage (LMV1032-15)**

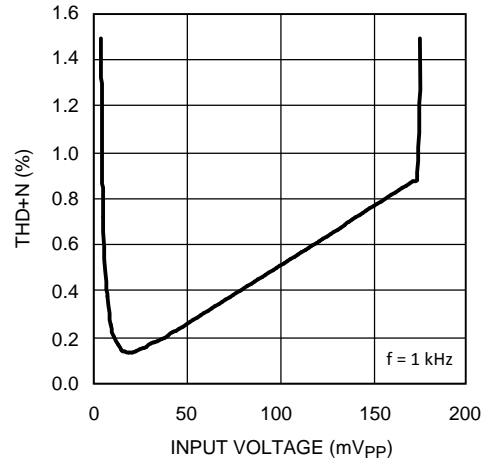

Figure 15.

**Total Harmonic Distortion vs. Input Voltage (LMV1032-25)**

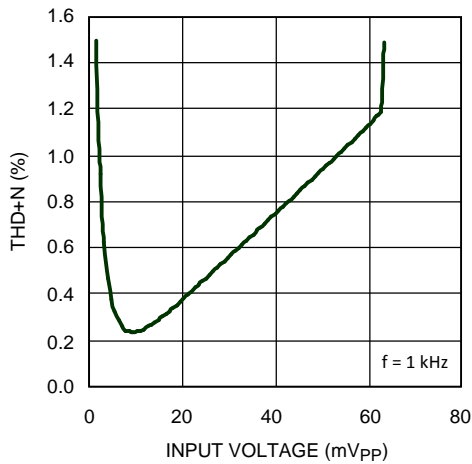

Figure 16.

**Output Voltage Noise vs. Frequency (LMV1032-06)**

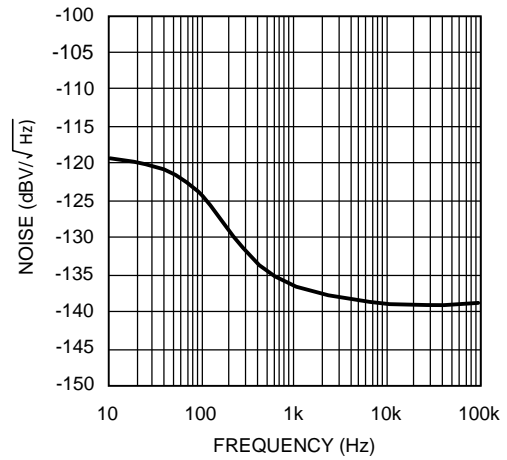

Figure 17.

**Output Voltage Noise vs. Frequency (LMV1032-15)**

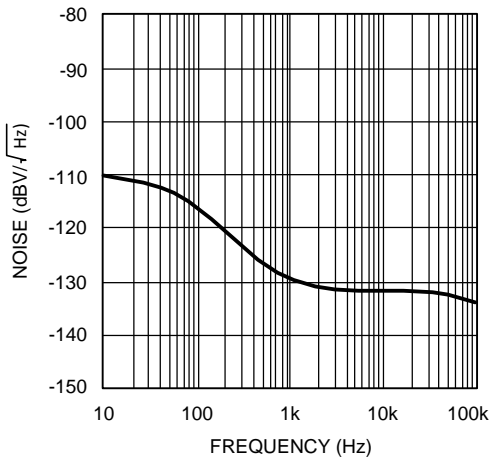

Figure 18.

**Output Voltage Noise vs. Frequency (LMV1032-25)**

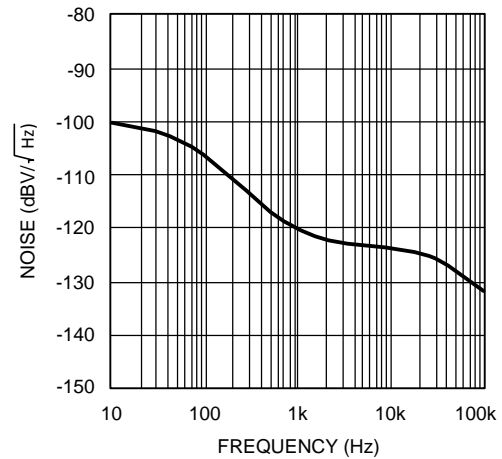

Figure 19.

## APPLICATION SECTION

### LOW CURRENT

The LMV1032 has a low supply current which allows for a longer battery life. The low supply current of 60µA makes this amplifier optimal for microphone applications which need to be always on.

### BUILT-IN GAIN

The LMV1032 is offered in the space saving small DSBGA package which fits perfectly into the metal can of a microphone. This allows the LMV1032 to be placed on the PCB inside the microphone.

The bottom side of the PCB has the pins that connect the supply voltage to the amplifier and make the output available. The input of the amplifier is connected to the microphone via the PCB.

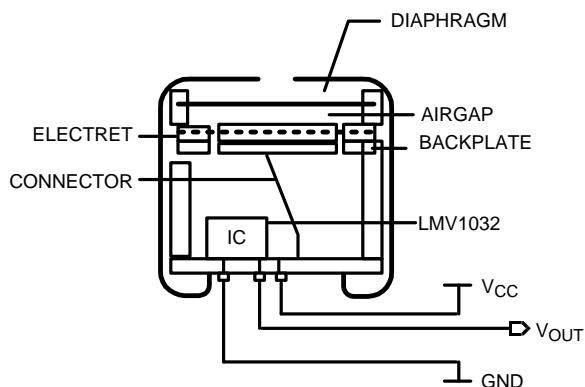

Figure 20. Built-in Gain

### A-WEIGHTED FILTER

The human ear has a frequency range from 20 Hz to about 20 kHz. Within this range the sensitivity of the human ear is not equal for each frequency. To approach the hearing response weighting filters are introduced. One of those filters is the A-weighted filter.

The A-weighted filter is usually used in signal-to-noise ratio measurements, where sound is compared to device noise. It improves the correlation of the measured data to the signal-to-noise ratio perceived by the human ear.

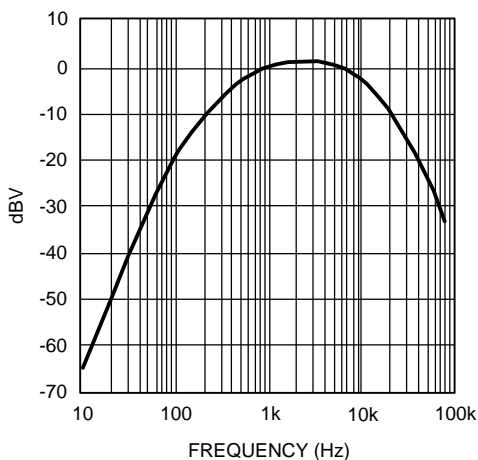
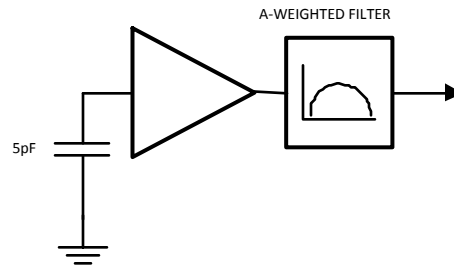

Figure 21. A-Weighted Filter

## MEASURING NOISE AND SNR

The overall noise of the LMV1032 is measured within the frequency band from 10 Hz to 22 kHz using an A-weighted filter. The input of the LMV1032 is connected to ground with a 5 pF capacitor.



**Figure 22. Noise Measurement Setup**

The signal-to-noise ratio (SNR) is measured with a 1 kHz input signal of 18 mV<sub>PP</sub> using an A-weighted filter. This represents a sound pressure level of 94 dB SPL. No input capacitor is connected.

## SOUND PRESSURE LEVEL

The volume of sound applied to a microphone is usually stated as the pressure level with respect to the threshold of hearing of the human ear. The sound pressure level (SPL) in decibels is defined by:

$$\text{Sound pressure level (dB)} = 20 \log P_m/P_o$$

Where,

$P_m$  is the measured sound pressure

$P_o$  is the threshold of hearing (20 μPa)

In order to be able to calculate the resulting output voltage of the microphone for a given SPL, the sound pressure in dB SPL needs to be converted to the absolute sound pressure in dBPa. This is the sound pressure level in decibels which is referred to as 1 Pascal (Pa).

The conversion is given by:

$$\text{dBPa} = \text{dB SPL} + 20 \cdot \log 20 \mu\text{Pa}$$

$$\text{dBPa} = \text{dB SPL} - 94 \text{ dB}$$

Translation from absolute sound pressure level to a voltage is specified by the sensitivity of the microphone. A conventional microphone has a sensitivity of -44 dBV/Pa.

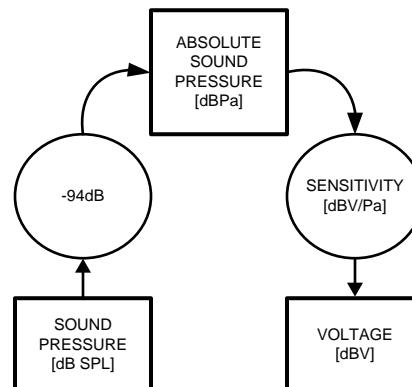

**Figure 23. dB SPL to dBV Conversion**

Example: Busy traffic is 70 dB SPL

$$V_{OUT} = 70 - 94 - 44 = -68 \text{ dBV}$$

This is equivalent to 1.13 mV<sub>PP</sub>

Since the LMV1032-15 has a gain of 5.6 (15 dB) over the JFET, the output voltage of the microphone is 6.35 mV<sub>PP</sub>. By replacing the JFET with the LMV1032-15, the sensitivity of the microphone is -29 dBV/Pa (-44 + 15).

### LOW FREQUENCY CUT OFF FILTER

To reduce noise on the output of the microphone a low cut filter has been implemented in the LMV1032. This filter reduces the effect of wind and handling noise.

It's also helpful to reduce the proximity effect in directional microphones. This effect occurs when the sound source is very close to the microphone. The lower frequencies are amplified which gives a bass sound. This amplification can cause an overload, which results in a distortion of the signal.

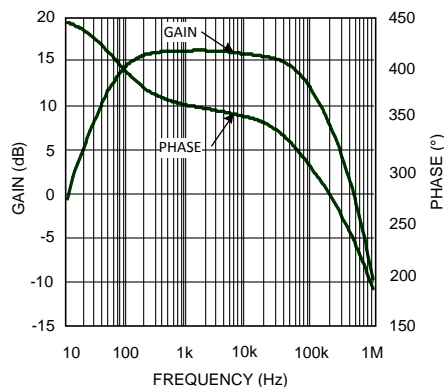

Figure 24. Gain vs. Frequency

The LMV1032 is optimized to be used in audio band applications. The LMV1032 provides a flat gain response within the audio band and offers linearity and excellent temperature stability.

### ADVANTAGE OF THREE PINS

The LMV1032 ECM solution has three pins instead of the two pins provided in the case of a JFET solution. The third pin provides the advantage of a low supply current, high PSRR and eliminates the need for additional components.

Noise pick-up by a microphone in a cell phone is a well-known problem. A conventional JFET circuit is sensitive for noise pick-up because of its high output impedance. The output impedance is usually around 2.2 kΩ. By providing separate output and supply pins a much lower output impedance is achieved and therefore is less sensitive to noise pick-up.

RF noise is among other caused by non-linear behavior. The non-linear behavior of the amplifier at high frequencies, well above the usable bandwidth of the device, causes AM demodulation of high frequency signals. The AM modulation contained in such signals folds back into the audio band, thereby disturbing the intended microphone signal. The GSM signal of a cell phone is such an AM-modulated signal. The modulation frequency of 216 Hz and its harmonics can be observed in the audio band. This type of noise is called bumblebee noise.

### EXTERNAL PRE-AMPLIFIER APPLICATION

The LMV1032 can also be used outside of an ECM as a space saving external pre-amplifier. In this application, the LMV1032 follows a phantom biased JFET microphone in the circuit. This is shown in Figure 25. The input of the LMV1032 is connected to the microphone via the 2.2 μF capacitor. The advantage of this circuit over one with only a JFET microphone are the additional gain and the high pass filter supplied by the LMV1032. The high pass filter makes the output signal more robust and less sensitive to low frequency disturbances. In this configuration the LMV1032 should be placed as close as possible to the microphone.

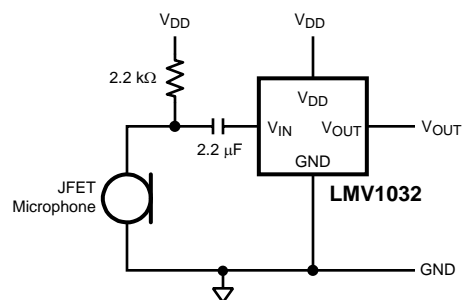

Figure 25. LMV1032 as External Pre-Amplifier

---

**REVISION HISTORY**

<b>Changes from Revision F (May 2013) to Revision G</b>	<b>Page</b>
• Changed layout of National Data Sheet to TI format .....	<a href="#">10</a>

---

**PACKAGING INFORMATION**

Orderable Device	Status (1)	Package Type	Package Drawing	Pins	Package Qty	Eco Plan (2)	Lead/Ball Finish (6)	MSL Peak Temp (3)	Op Temp (°C)	Device Marking (4/5)	Samples
LMV1032UP-06/NOPB	ACTIVE	DSBGA	YPC	4	250	Green (RoHS & no Sb/Br)	SNAGCU	Level-1-260C-UNLIM			<a href="#">Samples</a>
LMV1032UP-15/NOPB	ACTIVE	DSBGA	YPC	4	250	Green (RoHS & no Sb/Br)	SNAGCU	Level-1-260C-UNLIM			<a href="#">Samples</a>
LMV1032UP-25/NOPB	ACTIVE	DSBGA	YPC	4	250	Green (RoHS & no Sb/Br)	SNAGCU	Level-1-260C-UNLIM			<a href="#">Samples</a>
LMV1032UPX-06/NOPB	ACTIVE	DSBGA	YPC	4	3000	Green (RoHS & no Sb/Br)	SNAGCU	Level-1-260C-UNLIM	-40 to 85		<a href="#">Samples</a>
LMV1032UR-15/NOPB	ACTIVE	DSBGA	YPD	4	250	Green (RoHS & no Sb/Br)	SNAGCU	Level-1-260C-UNLIM			<a href="#">Samples</a>
LMV1032UR-25/NOPB	ACTIVE	DSBGA	YPD	4	250	Green (RoHS & no Sb/Br)	SNAGCU	Level-1-260C-UNLIM			<a href="#">Samples</a>
LMV1032URX-15/NOPB	ACTIVE	DSBGA	YPD	4	3000	Green (RoHS & no Sb/Br)	SNAGCU	Level-1-260C-UNLIM	-40 to 85		<a href="#">Samples</a>
LMV1032URX-25/NOPB	ACTIVE	DSBGA	YPD	4	3000	Green (RoHS & no Sb/Br)	SNAGCU	Level-1-260C-UNLIM	-40 to 85		<a href="#">Samples</a>

(1) The marketing status values are defined as follows:

**ACTIVE:** Product device recommended for new designs.

**LIFEBUY:** TI has announced that the device will be discontinued, and a lifetime-buy period is in effect.

**NRND:** Not recommended for new designs. Device is in production to support existing customers, but TI does not recommend using this part in a new design.

**PREVIEW:** Device has been announced but is not in production. Samples may or may not be available.

**OBSELETE:** TI has discontinued the production of the device.

(2) **RoHS:** TI defines "RoHS" to mean semiconductor products that are compliant with the current EU RoHS requirements for all 10 RoHS substances, including the requirement that RoHS substance do not exceed 0.1% by weight in homogeneous materials. Where designed to be soldered at high temperatures, "RoHS" products are suitable for use in specified lead-free processes. TI may reference these types of products as "Pb-Free".

**RoHS Exempt:** TI defines "RoHS Exempt" to mean products that contain lead but are compliant with EU RoHS pursuant to a specific EU RoHS exemption.

**Green:** TI defines "Green" to mean the content of Chlorine (Cl) and Bromine (Br) based flame retardants meet JS709B low halogen requirements of <=1000ppm threshold. Antimony trioxide based flame retardants must also meet the <=1000ppm threshold requirement.

(3) MSL, Peak Temp. - The Moisture Sensitivity Level rating according to the JEDEC industry standard classifications, and peak solder temperature.

(4) There may be additional marking, which relates to the logo, the lot trace code information, or the environmental category on the device.

<sup>(5)</sup> Multiple Device Markings will be inside parentheses. Only one Device Marking contained in parentheses and separated by a "-" will appear on a device. If a line is indented then it is a continuation of the previous line and the two combined represent the entire Device Marking for that device.

<sup>(6)</sup> Lead/Ball Finish - Orderable Devices may have multiple material finish options. Finish options are separated by a vertical ruled line. Lead/Ball Finish values may wrap to two lines if the finish value exceeds the maximum column width.

**Important Information and Disclaimer:**The information provided on this page represents TI's knowledge and belief as of the date that it is provided. TI bases its knowledge and belief on information provided by third parties, and makes no representation or warranty as to the accuracy of such information. Efforts are underway to better integrate information from third parties. TI has taken and continues to take reasonable steps to provide representative and accurate information but may not have conducted destructive testing or chemical analysis on incoming materials and chemicals. TI and TI suppliers consider certain information to be proprietary, and thus CAS numbers and other limited information may not be available for release.

In no event shall TI's liability arising out of such information exceed the total purchase price of the TI part(s) at issue in this document sold by TI to Customer on an annual basis.

**TAPE AND REEL INFORMATION**

**QUADRANT ASSIGNMENTS FOR PIN 1 ORIENTATION IN TAPE**

\*All dimensions are nominal

Device	Package Type	Package Drawing	Pins	SPQ	Reel Diameter (mm)	Reel Width W1 (mm)	A0 (mm)	B0 (mm)	K0 (mm)	P1 (mm)	W (mm)	Pin1 Quadrant
LMV1032UP-06/NOPB	DSBGA	YPC	4	250	178.0	8.4	1.22	1.22	0.56	4.0	8.0	Q1
LMV1032UP-15/NOPB	DSBGA	YPC	4	250	178.0	8.4	1.22	1.22	0.56	4.0	8.0	Q1
LMV1032UP-25/NOPB	DSBGA	YPC	4	250	178.0	8.4	1.22	1.22	0.56	4.0	8.0	Q1
LMV1032UPX-06/NOPB	DSBGA	YPC	4	3000	178.0	8.4	1.22	1.22	0.56	4.0	8.0	Q1
LMV1032UR-15/NOPB	DSBGA	YPD	4	250	178.0	8.4	1.22	1.22	0.56	4.0	8.0	Q1
LMV1032UR-25/NOPB	DSBGA	YPD	4	250	178.0	8.4	1.22	1.22	0.56	4.0	8.0	Q1
LMV1032URX-15/NOPB	DSBGA	YPD	4	3000	178.0	8.4	1.22	1.22	0.56	4.0	8.0	Q1
LMV1032URX-25/NOPB	DSBGA	YPD	4	3000	178.0	8.4	1.22	1.22	0.56	4.0	8.0	Q1

**TAPE AND REEL BOX DIMENSIONS**

\*All dimensions are nominal

Device	Package Type	Package Drawing	Pins	SPQ	Length (mm)	Width (mm)	Height (mm)
LMV1032UP-06/NOPB	DSBGA	YPC	4	250	210.0	185.0	35.0
LMV1032UP-15/NOPB	DSBGA	YPC	4	250	210.0	185.0	35.0
LMV1032UP-25/NOPB	DSBGA	YPC	4	250	210.0	185.0	35.0
LMV1032UPX-06/NOPB	DSBGA	YPC	4	3000	210.0	185.0	35.0
LMV1032UR-15/NOPB	DSBGA	YPD	4	250	210.0	185.0	35.0
LMV1032UR-25/NOPB	DSBGA	YPD	4	250	210.0	185.0	35.0
LMV1032URX-15/NOPB	DSBGA	YPD	4	3000	210.0	185.0	35.0
LMV1032URX-25/NOPB	DSBGA	YPD	4	3000	210.0	185.0	35.0

YPC0004

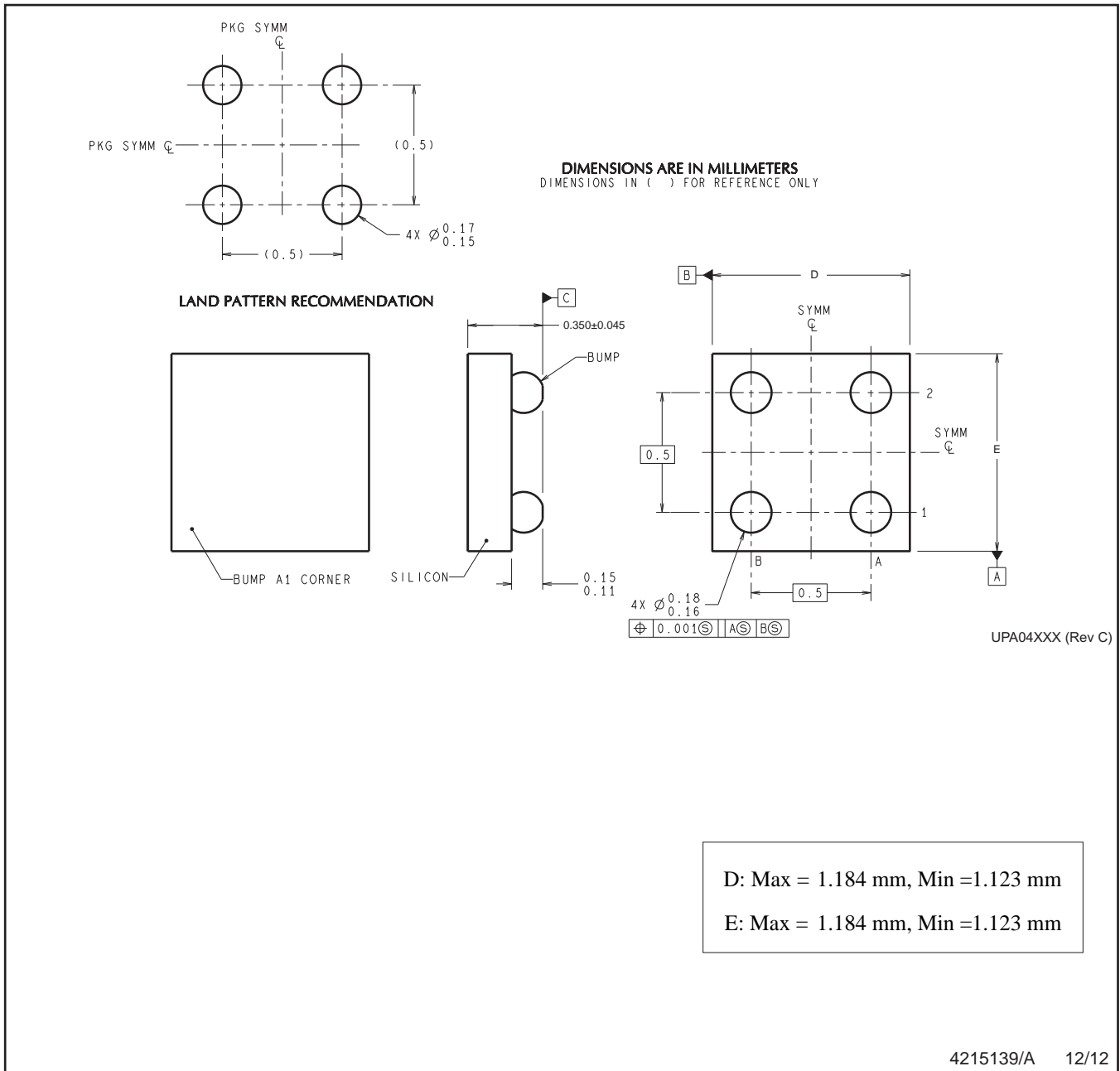

NOTES: A. All linear dimensions are in millimeters. Dimensioning and tolerancing per ASME Y14.5M-1994.  
B. This drawing is subject to change without notice.

YPD0004

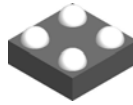

# PACKAGE OUTLINE

DSBGA - 0.395 mm max height

DIE SIZE BALL GRID ARRAY

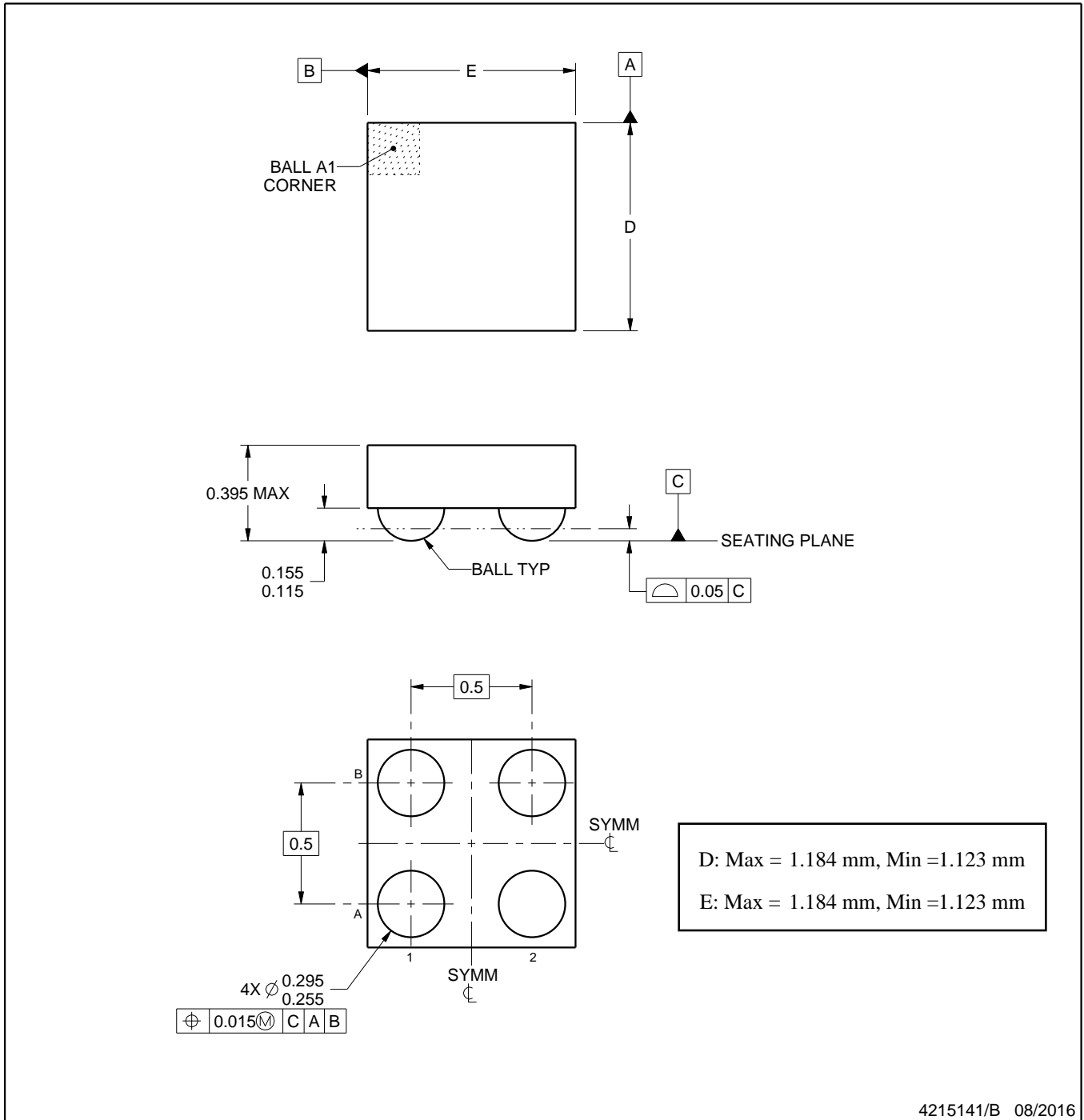

NOTES:

- 1. All linear dimensions are in millimeters. Any dimensions in parenthesis are for reference only. Dimensioning and tolerancing per ASME Y14.5M.
- 2. This drawing is subject to change without notice.

# EXAMPLE BOARD LAYOUT

YPD0004

DSBGA - 0.395 mm max height

DIE SIZE BALL GRID ARRAY

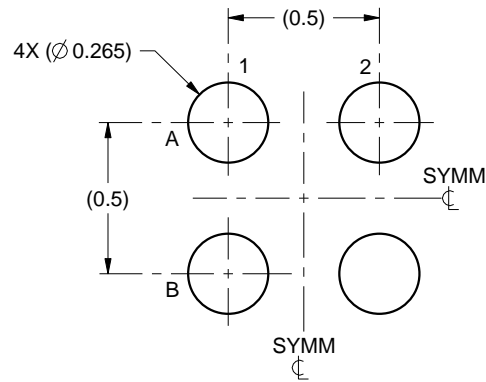

LAND PATTERN EXAMPLE  
SCALE:40X

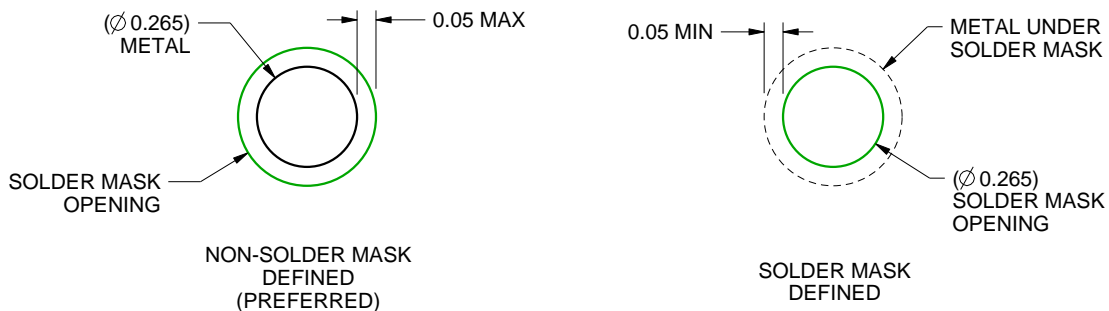

SOLDER MASK DETAILS  
NOT TO SCALE

4215141/B 08/2016

NOTES: (continued)

- 3. Final dimensions may vary due to manufacturing tolerance considerations and also routing constraints. See Texas Instruments Literature No. SNVA009 ([www.ti.com/lit/snva009](http://www.ti.com/lit/snva009)).

# EXAMPLE STENCIL DESIGN

YPD0004

DSBGA - 0.395 mm max height

DIE SIZE BALL GRID ARRAY

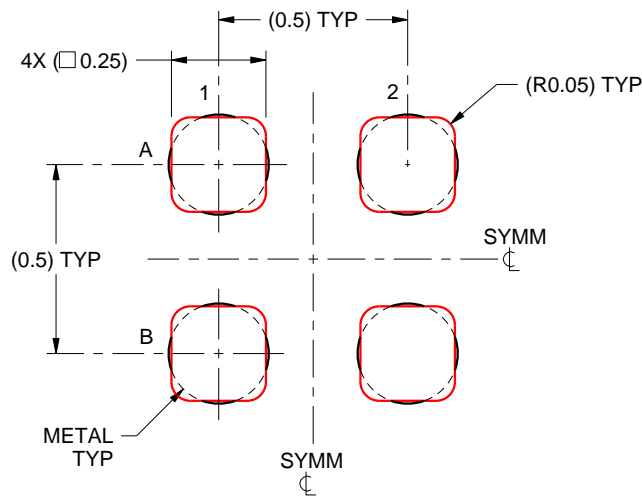

SOLDER PASTE EXAMPLE  
BASED ON 0.1 mm THICK STENCIL  
SCALE:50X

4215141/B 08/2016

NOTES: (continued)

4. Laser cutting apertures with trapezoidal walls and rounded corners may offer better paste release.

## IMPORTANT NOTICE

Texas Instruments Incorporated (TI) reserves the right to make corrections, enhancements, improvements and other changes to its semiconductor products and services per JESD46, latest issue, and to discontinue any product or service per JESD48, latest issue. Buyers should obtain the latest relevant information before placing orders and should verify that such information is current and complete.

TI's published terms of sale for semiconductor products (<http://www.ti.com/sc/docs/stdterms.htm>) apply to the sale of packaged integrated circuit products that TI has qualified and released to market. Additional terms may apply to the use or sale of other types of TI products and services.

Reproduction of significant portions of TI information in TI data sheets is permissible only if reproduction is without alteration and is accompanied by all associated warranties, conditions, limitations, and notices. TI is not responsible or liable for such reproduced documentation. Information of third parties may be subject to additional restrictions. Resale of TI products or services with statements different from or beyond the parameters stated by TI for that product or service voids all express and any implied warranties for the associated TI product or service and is an unfair and deceptive business practice. TI is not responsible or liable for any such statements.

Buyers and others who are developing systems that incorporate TI products (collectively, "Designers") understand and agree that Designers remain responsible for using their independent analysis, evaluation and judgment in designing their applications and that Designers have full and exclusive responsibility to assure the safety of Designers' applications and compliance of their applications (and of all TI products used in or for Designers' applications) with all applicable regulations, laws and other applicable requirements. Designer represents that, with respect to their applications, Designer has all the necessary expertise to create and implement safeguards that (1) anticipate dangerous consequences of failures, (2) monitor failures and their consequences, and (3) lessen the likelihood of failures that might cause harm and take appropriate actions. Designer agrees that prior to using or distributing any applications that include TI products, Designer will thoroughly test such applications and the functionality of such TI products as used in such applications.

TI's provision of technical, application or other design advice, quality characterization, reliability data or other services or information, including, but not limited to, reference designs and materials relating to evaluation modules, (collectively, "TI Resources") are intended to assist designers who are developing applications that incorporate TI products; by downloading, accessing or using TI Resources in any way, Designer (individually or, if Designer is acting on behalf of a company, Designer's company) agrees to use any particular TI Resource solely for this purpose and subject to the terms of this Notice.

TI's provision of TI Resources does not expand or otherwise alter TI's applicable published warranties or warranty disclaimers for TI products, and no additional obligations or liabilities arise from TI providing such TI Resources. TI reserves the right to make corrections, enhancements, improvements and other changes to its TI Resources. TI has not conducted any testing other than that specifically described in the published documentation for a particular TI Resource.

Designer is authorized to use, copy and modify any individual TI Resource only in connection with the development of applications that include the TI product(s) identified in such TI Resource. NO OTHER LICENSE, EXPRESS OR IMPLIED, BY ESTOPPEL OR OTHERWISE TO ANY OTHER TI INTELLECTUAL PROPERTY RIGHT, AND NO LICENSE TO ANY TECHNOLOGY OR INTELLECTUAL PROPERTY RIGHT OF TI OR ANY THIRD PARTY IS GRANTED HEREIN, including but not limited to any patent right, copyright, mask work right, or other intellectual property right relating to any combination, machine, or process in which TI products or services are used. Information regarding or referencing third-party products or services does not constitute a license to use such products or services, or a warranty or endorsement thereof. Use of TI Resources may require a license from a third party under the patents or other intellectual property of the third party, or a license from TI under the patents or other intellectual property of TI.

TI RESOURCES ARE PROVIDED "AS IS" AND WITH ALL FAULTS. TI DISCLAIMS ALL OTHER WARRANTIES OR REPRESENTATIONS, EXPRESS OR IMPLIED, REGARDING RESOURCES OR USE THEREOF, INCLUDING BUT NOT LIMITED TO ACCURACY OR COMPLETENESS, TITLE, ANY EPIDEMIC FAILURE WARRANTY AND ANY IMPLIED WARRANTIES OF MERCHANTABILITY, FITNESS FOR A PARTICULAR PURPOSE, AND NON-INFRINGEMENT OF ANY THIRD PARTY INTELLECTUAL PROPERTY RIGHTS. TI SHALL NOT BE LIABLE FOR AND SHALL NOT DEFEND OR INDEMNIFY DESIGNER AGAINST ANY CLAIM, INCLUDING BUT NOT LIMITED TO ANY INFRINGEMENT CLAIM THAT RELATES TO OR IS BASED ON ANY COMBINATION OF PRODUCTS EVEN IF DESCRIBED IN TI RESOURCES OR OTHERWISE. IN NO EVENT SHALL TI BE LIABLE FOR ANY ACTUAL, DIRECT, SPECIAL, COLLATERAL, INDIRECT, PUNITIVE, INCIDENTAL, CONSEQUENTIAL OR EXEMPLARY DAMAGES IN CONNECTION WITH OR ARISING OUT OF TI RESOURCES OR USE THEREOF, AND REGARDLESS OF WHETHER TI HAS BEEN ADVISED OF THE POSSIBILITY OF SUCH DAMAGES.

Unless TI has explicitly designated an individual product as meeting the requirements of a particular industry standard (e.g., ISO/TS 16949 and ISO 26262), TI is not responsible for any failure to meet such industry standard requirements.

Where TI specifically promotes products as facilitating functional safety or as compliant with industry functional safety standards, such products are intended to help enable customers to design and create their own applications that meet applicable functional safety standards and requirements. Using products in an application does not by itself establish any safety features in the application. Designers must ensure compliance with safety-related requirements and standards applicable to their applications. Designer may not use any TI products in life-critical medical equipment unless authorized officers of the parties have executed a special contract specifically governing such use. Life-critical medical equipment is medical equipment where failure of such equipment would cause serious bodily injury or death (e.g., life support, pacemakers, defibrillators, heart pumps, neurostimulators, and implantables). Such equipment includes, without limitation, all medical devices identified by the U.S. Food and Drug Administration as Class III devices and equivalent classifications outside the U.S.

TI may expressly designate certain products as completing a particular qualification (e.g., Q100, Military Grade, or Enhanced Product). Designers agree that it has the necessary expertise to select the product with the appropriate qualification designation for their applications and that proper product selection is at Designers' own risk. Designers are solely responsible for compliance with all legal and regulatory requirements in connection with such selection.

Designer will fully indemnify TI and its representatives against any damages, costs, losses, and/or liabilities arising out of Designer's non-compliance with the terms and provisions of this Notice.

## Looking for pricing, stock, or lifecycle information?

Click below to explore more details on WIN SOURCE:

 [View LMV1032URX-15/NOPB on WIN SOURCE](#)

 [Texas Instruments](#) Information

## Optimize Your Supply Chain with WIN SOURCE Solutions

-  Global Sourcing Solution
-  Obsolete Management
-  Cost Control Management
-  Shortage Management
-  Alternative Solution
-  Excess Inventory Management