



**THE DATASHEET OF
AD8018ARZ-REEL7**



FEATURES

Ideal xDSL Line Drive Amplifier for USB, PCMCIA, or PCI-Based Customer Premise Equipment (CPE). The AD8018 provides maximum reach on 5 V supply, driving 16 dBm of power into a back-terminated, transformer-coupled 100 Ω while maintaining -82 dBc of out-of-band SFDR.

Rail-to-Rail Output Voltage and High Output Current Drive

400 mA Output Current into Differential Load of 10 Ω @ 8 V p-p

Low Single-Tone Distortion

-86 dBc Worst Harmonic, 6 V p-p into Differential 10 Ω @ 100 kHz

Low Noise

4.5 nV/ $\sqrt{\text{Hz}}$ Voltage Noise Density, 100 kHz

Out-of-Band SFDR = -82 dBc, 144 kHz to 500 kHz,

$R_{\text{LOAD}} = 12.5 \Omega$, $P_{\text{LINE}} = 13$ dBm

Low-Power Operation

3.3 V to 8 V Power Supply Range

Two Logic Bits for Standby and Shutdown

Low Supply Current of 9 mA/Amplifier (Typ)

Current Feedback Amplifiers

High Speed

130 MHz Bandwidth (-3 dB)

300 V/ μs Slew Rate

APPLICATIONS

xDSL USB, PCI, PCMCIA Cards

Consumer DSL Modems

Twisted Pair Line Driver

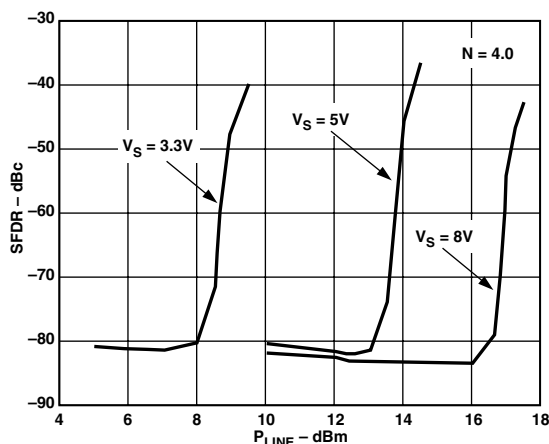
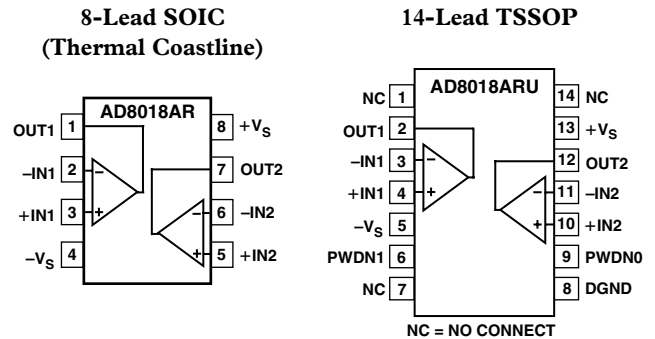

Figure 1. Out-of-Band SFDR vs. ADSL Upstream Line Power; $V_S = 5$ V, $N = 4$ Turns, 144 kHz to 500 kHz. See Evaluation Board Schematics in Figure 11.

REV. A

Information furnished by Analog Devices is believed to be accurate and reliable. However, no responsibility is assumed by Analog Devices for its use, nor for any infringements of patents or other rights of third parties which may result from its use. No license is granted by implication or otherwise under any patent or patent rights of Analog Devices.

PIN CONFIGURATIONS



PRODUCT DESCRIPTION

The AD8018 is intended for use in single-supply (5 V) xDSL modems where high-output current and low distortion are essential to achieve maximum reach. The dual high-speed amplifiers are capable of driving low distortion signals to within 0.5 V of the power supply rail. Each amplifier can drive 400 mA of current into 10 Ω (differential) while maintaining -82 dBc out-of-band SFDR. The AD8018 is available with flexible standby and shutdown modes. Two digital logic bits (PWDN1 and PWDN0) may be used to put the AD8018 into one of three modes: full power, standby (outputs low impedance), and shutdown (outputs high impedance).

Fabricated with ADI's high-speed XFCB (eXtra Fast Complementary Bipolar) process, the high bandwidth and fast slew rate of the AD8018 keep distortion to a minimum, while dissipating a minimum of power. The quiescent current of the AD8018 is a low 9 mA/amplifier. The AD8018 drive capability comes in compact 8-lead Thermal Coastline SOIC and 14-lead TSSOP packages. Low-distortion, rail-to-rail output voltage, and high-current drive in small packages make the AD8018 ideal for use in low-cost USB, PCMCIA, and PCI Customer Premise Equipment for ADSL, SDSL, VDSL, and proprietary xDSL systems. Both models will operate over the temperature range -40°C to $+85^\circ\text{C}$.

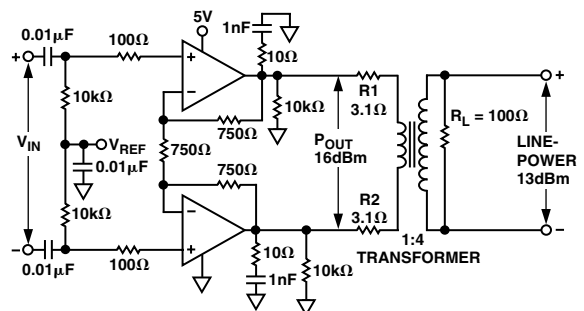

Figure 2. Single-Supply Voltage Differential Drive Circuit for xDSL Applications

AD8018—SPECIFICATIONS (@ 25°C, V_S = 5 V, R_L = 100 Ω, R_F = R_G = 750 Ω unless otherwise noted.)

Parameter	Conditions	Min	Typ	Max	Unit
DYNAMIC PERFORMANCE					
–3 dB Bandwidth	G = 1, V _{OUT} < 0.4 V p-p, R _L = 5 Ω	40	50		MHz
	G = 1, V _{OUT} < 0.4 V p-p, R _L = 100 Ω	100	130		MHz
	G = 2, V _{OUT} < 0.4 V p-p, R _L = 5 Ω	35	40		MHz
	G = 2, V _{OUT} < 0.4 V p-p, R _L = 100 Ω	80	100		MHz
0.1 dB Bandwidth	V _{OUT} < 0.4 V p-p, R _L = 100 Ω		10		MHz
Large Signal Bandwidth	V _{OUT} = 4 V p-p, G = +2		80		MHz
Slew Rate	Noninverting, V _{OUT} = 4 V p-p		300		V/μs
Rise and Fall Time	Noninverting, V _{OUT} = 2 V p-p		5.5		ns
Settling Time	0.1%, V _{OUT} = 2 V p-p, R _L = 100 Ω		25		ns
NOISE/HARMONIC PERFORMANCE					
Distortion, Second Harmonic	V _{OUT} = 6 V p-p (Differential)				
	100 kHz, R _L = 10 Ω	–89	–94		dBc
Third Harmonic	500 kHz, R _L = 10 Ω	–61	–63		dBc
	100 kHz, R _L = 10 Ω	–86	–89		dBc
MTPR (In-Band)	500 kHz, R _L = 10 Ω	–74	–77		dBc
	25 kHz to 138 kHz, R _L = 12.5 Ω, P _{LINE} = +13 dBm		–70		dBc
SFDR (Out-of-Band)	144 kHz to 500 kHz, R _L = 12.5 Ω, P _{LINE} = +13 dBm		–82		dBc
Input Noise Voltage	f = 100 kHz		4.5	5	nV√Hz
Input Noise Current	f = 100 kHz (+Inputs)		1		pA√Hz
	f = 100 kHz (–Inputs)		10		pA√Hz
Crosstalk	f = 1 MHz, G = +2		–74		dB
DC PERFORMANCE					
Input Offset Voltage	T _{MIN} to T _{MAX}		1	15	mV
				17	mV
Input Offset Voltage Match			0.1	2.6	mV
Transimpedance	V _{OUT} = 2 V p-p, R _L = 5 Ω	830	2000		kΩ
	T _{MIN} to T _{MAX}	700			kΩ
INPUT CHARACTERISTICS					
Input Resistance	+Input		10		MΩ
		–Input	125		Ω
Input Capacitance	+Input		1		pF
Input Bias Current (–)	T _{MIN} to T _{MAX}		0.3	8	μA
				14	μA
Input Bias Current (–) Match	T _{MIN} to T _{MAX}		0.1	5.5	μA
				8	μA
Input Bias Current (+)	T _{MIN} to T _{MAX}		1	1.5	μA
				2.5	μA
Input Bias Current (+) Match	T _{MIN} to T _{MAX}		0.1	0.5	μA
				1	μA
CMRR	T _{MIN} to T _{MAX}	51	54		dB
Input CM Voltage Range	V _{IN} 2 V to 4 V	1.2		3.8	V
OUTPUT CHARACTERISTICS					
Cap Load	30% Overshoot		1000		pF
Output Resistance	Frequency = 100 kHz, PWDN1, PWDN0 = 1		0.2		Ω
Output Voltage Swing	R _L = 100 Ω		0.16 to 4.87		V
	R _L = 5 Ω		0.5 to 4.5		V
Linear Output Current	SFDR < –85 dBc, f = 100 kHz, R _L = 10 Ω, Differential	350	400		mA
Short-Circuit Current			1000		mA
POWER SUPPLY					
Supply Current/Amp	PWDN1 = 1, PWDN0 = 1		9	10	mA
	T _{MIN} to T _{MAX}			11.4	mA
STBY Supply Current/Amp	PWDN1 = 0, PWDN0 = 1 or		4.5	5.1	mA
	PWDN1 = 1, PWDN0 = 0		4.5	5.1	mA
SHUTDOWN Supply Current/Amp	PWDN1 = 0, PWDN0 = 0		0.3	0.55	mA
Operating Range	Single Supply	3.3		8	V
+Power Supply Rejection Ratio	ΔV _S = ±1 V	60	66		dB
	T _{MIN} to T _{MAX}	56			dB
–Power Supply Rejection Ratio	ΔV _S = ±1 V	52	55		dB
	T _{MIN} to T _{MAX}	50			dB

Parameter	Conditions	Min	Typ	Max	Unit
LOGIC INPUTS (PWDN1, 0)					
Logic "1" Voltage		2.0			V
Logic "0" Voltage				0.8	V
Logic Input Bias Current			240		μ A
Standby Recovery Time	$R_L = 10 \Omega$, $G = +2$, $I_S = 90\%$ of Typical		500		ns

Specifications subject to change without notice.

ABSOLUTE MAXIMUM RATINGS¹

Supply Voltage	8 V
Internal Power Dissipation ²	
Small Outline Package (R)	650 mW
TSSOP Package (RU)	565 mW
Input Voltage (Common-Mode)	$\pm V_S$
Logic Voltage, PWDN0, 1	$\pm V_S$
Differential Input Voltage	± 1.6 V
Output Short Circuit Duration	Observe Power Derating Curves
Storage Temperature Range RU, R	-65°C to +150°C
Operating Temperature Range	-40°C to +85°C
Lead Temperature Range (Soldering 10 sec)	300°C

NOTES

¹Stresses above those listed under Absolute Maximum Ratings may cause permanent damage to the device. This is a stress rating only; functional operation of the device at these or any other conditions above those indicated in the operational section of this specification is not implied. Exposure to absolute maximum rating conditions for extended periods may affect device reliability.

²Specification is for the device on a 4-layer board in free air at 85°C:

8-Lead SOIC Package: $\theta_{JA} = 100^\circ\text{C/W}$.

14-Lead TSSOP Package: $\theta_{JA} = 115^\circ\text{C/W}$.

ORDERING GUIDE

Model	Temperature Range	Package Description	Package Option
AD8018AR	-40°C to +85°C	8-Lead Plastic SOIC	SO-8
AD8018AR-REEL	-40°C to +85°C	8-Lead SOIC	SO-8
AD8018AR-REEL7	-40°C to +85°C	8-Lead SOIC	SO-8
AD8018ARU	-40°C to +85°C	14-Lead Plastic TSSOP	RU-14
AD8018ARU-REEL	-40°C to +85°C	14-Lead Plastic TSSOP	RU-14
AD8018ARU-REEL7	-40°C to +85°C	14-Lead Plastic TSSOP	RU-14
AD8018ARU-EVAL		Evaluation Board	RU-14

CAUTION

ESD (electrostatic discharge) sensitive device. Electrostatic charges as high as 4000 V readily accumulate on the human body and test equipment and can discharge without detection. Although the AD8018 features proprietary ESD protection circuitry, permanent damage may occur on devices subjected to high-energy electrostatic discharges. Therefore, proper ESD precautions are recommended to avoid performance degradation or loss of functionality.

MAXIMUM POWER DISSIPATION

The maximum power that can be safely dissipated by the AD8018 is limited by the associated rise in junction temperature. The maximum safe junction temperature for plastic encapsulated devices is determined by the glass transition temperature of the plastic, approximately 150°C. Temporarily exceeding this limit may cause a shift in parametric performance due to a change in the stresses exerted on the die by the package. Exceeding a junction temperature of 175°C for an extended period can result in device failure.

While the AD8018 is internally short circuit protected, this may not be sufficient to guarantee that the maximum junction temperature (150°C) is not exceeded under all conditions. To ensure proper operation, it is necessary to observe the maximum power derating curves.

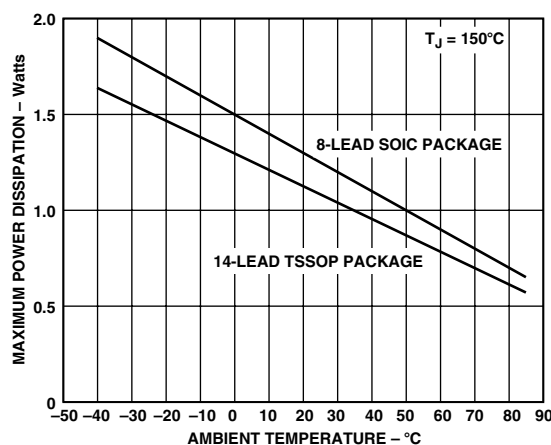
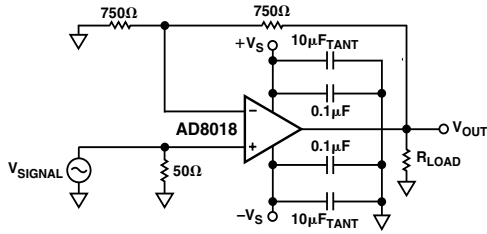

Figure 3. Plot of Maximum Power Dissipation vs. Temperature



AD8018—Typical Performance Characteristics



TPC 1. Single-Ended Test Circuit

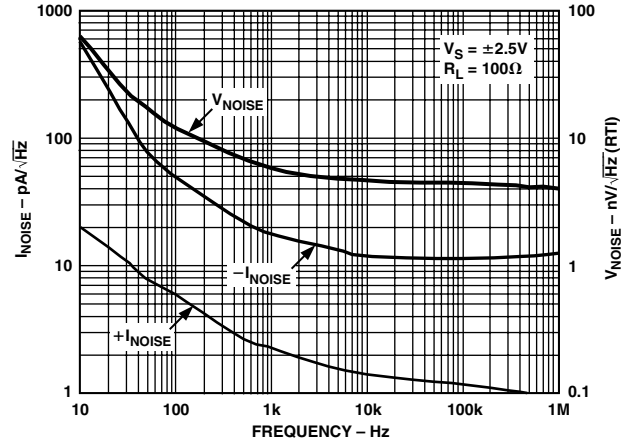

TPC 4. I_{NOISE} and V_{NOISE} vs. Frequency

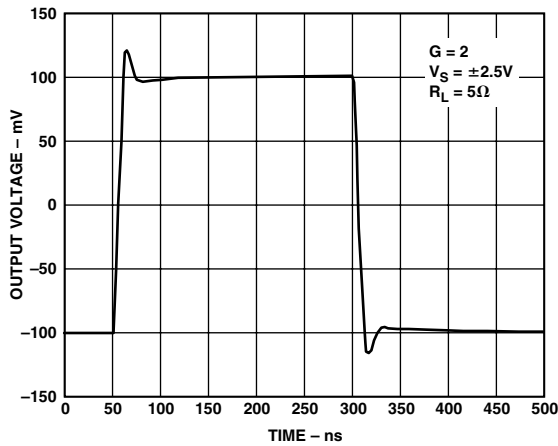

TPC 2. Small Signal Step Response

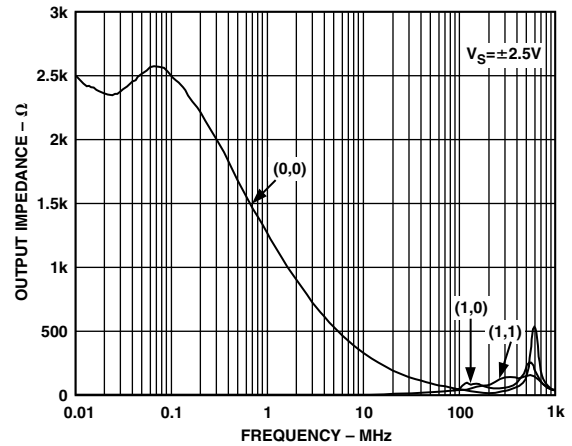

TPC 5. Output Impedance vs. Frequency, for Full Power, Standby, and Shutdown Modes

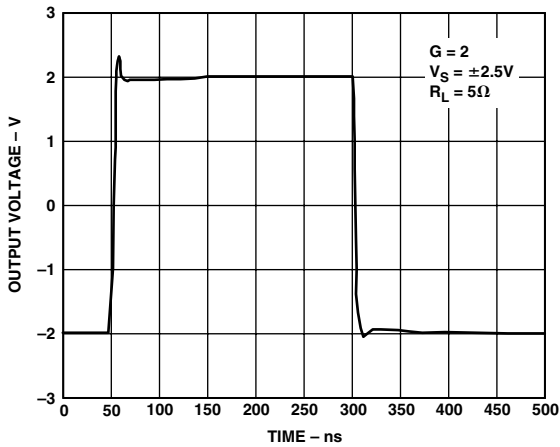

TPC 3. Large Signal Step Response

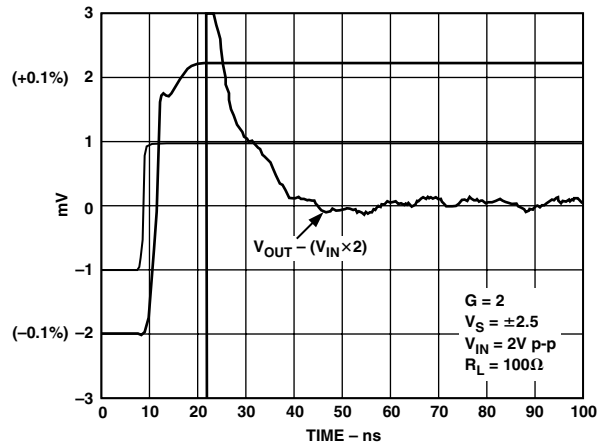

TPC 6. 0.1% Settling Time

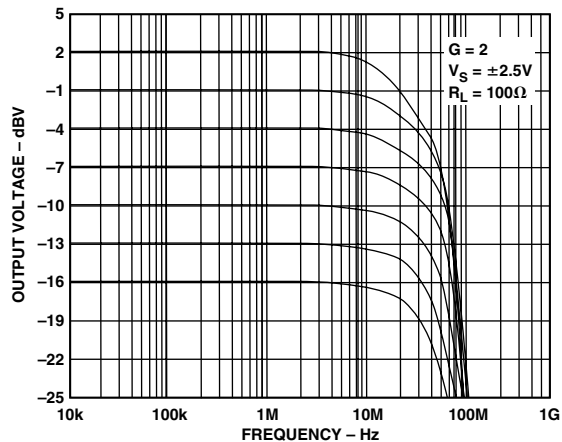

TPC 7. Output Voltage vs. Frequency

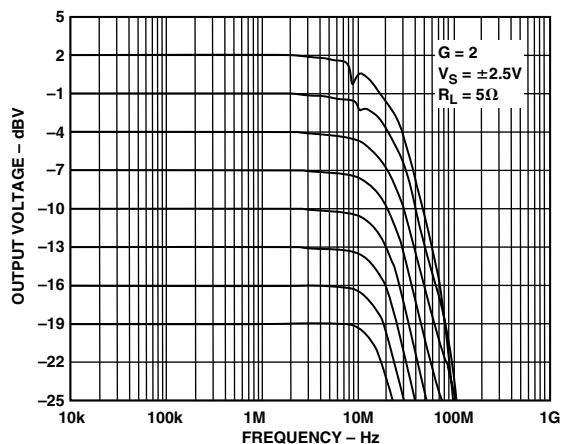

TPC 10. Output Voltage vs. Frequency

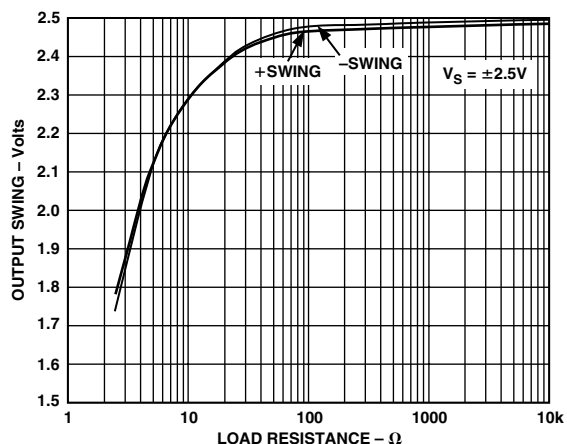

TPC 8. Output Swing vs. R_{LOAD}

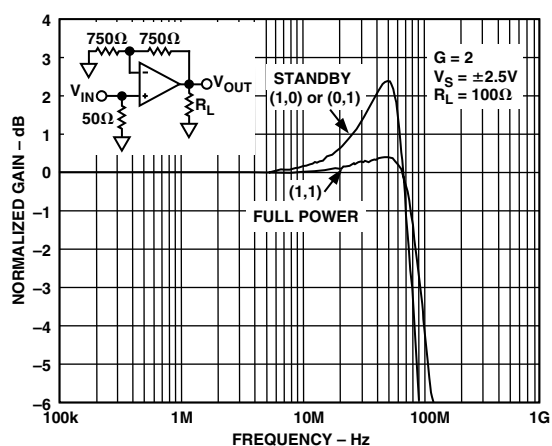

TPC 11. Small Signal Frequency Response

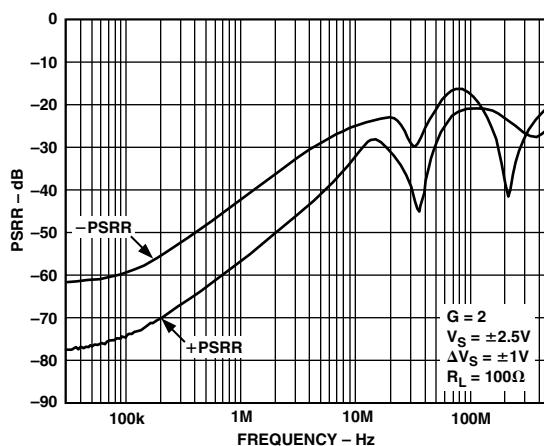

TPC 9. PSRR vs. Frequency

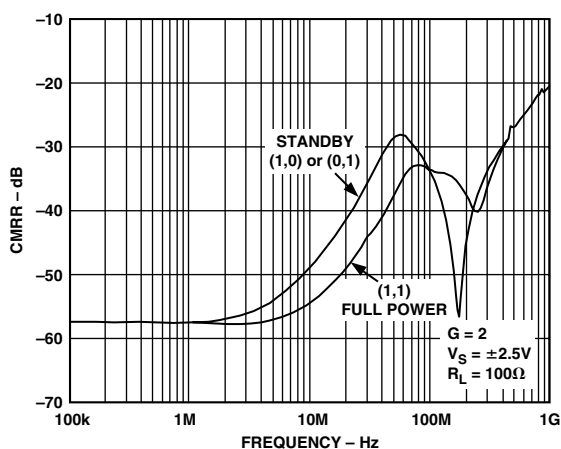

TPC 12. CMRR vs. Frequency, Full Power, and Standby Mode

AD8018

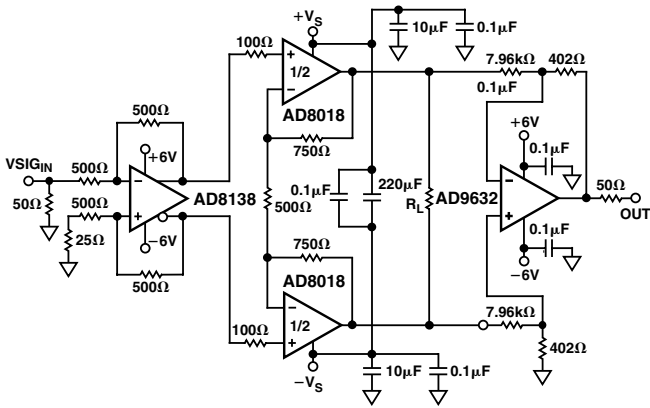

TPC 13. Differential Test Circuit

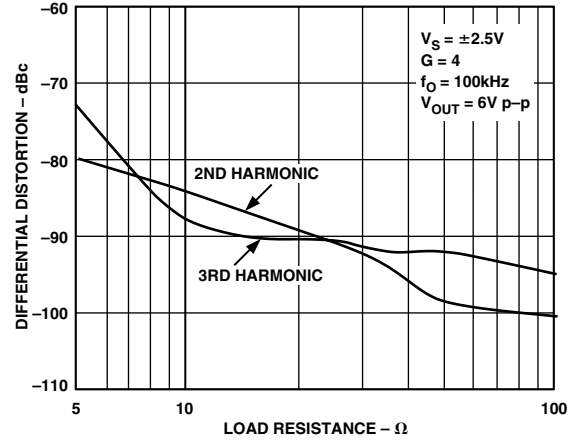

TPC 16. Differential Distortion vs. R_{LOAD}

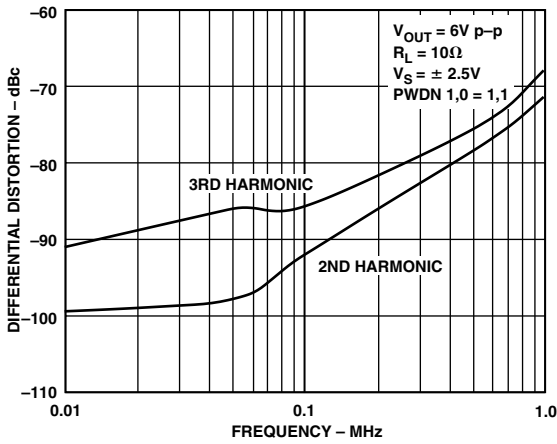

TPC 14. Differential Distortion vs. Frequency

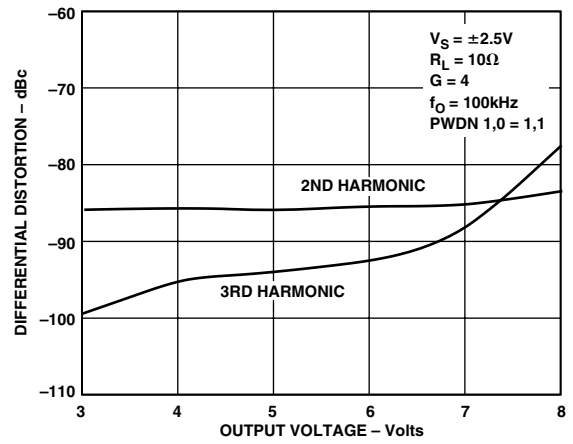

TPC 17. Differential Distortion vs. Peak-to-Peak Output Voltage

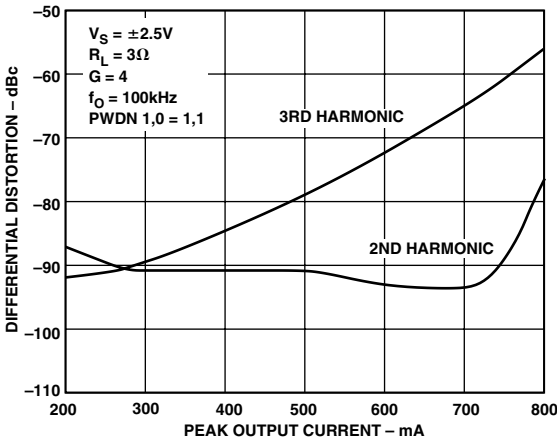

TPC 15. Differential Distortion vs. Peak Output Current

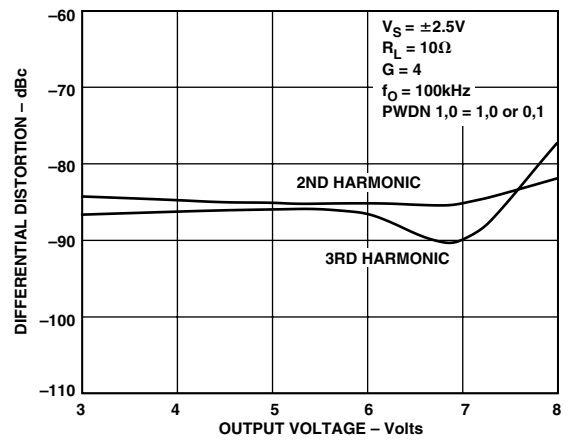

TPC 18. Differential Distortion vs. Peak-to-Peak Output Voltage

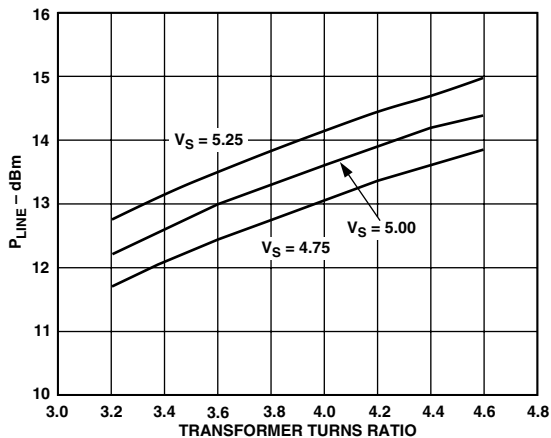

TPC 19. Line Power vs. Turns Ratio; MTPR = -65 dBc, f = 43 kHz

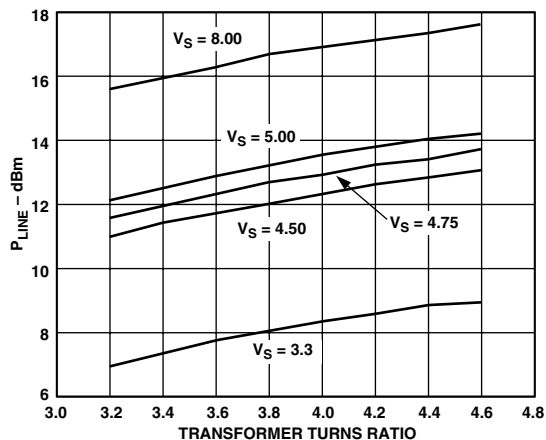

TPC 22. Line Power vs. Turns Ratio; -75 dBc Out-of-Band SFDR, f = 361 kHz

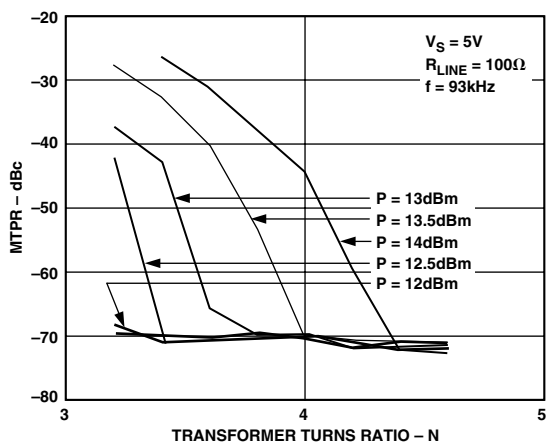

TPC 20. MTPR vs. Turns Ratio

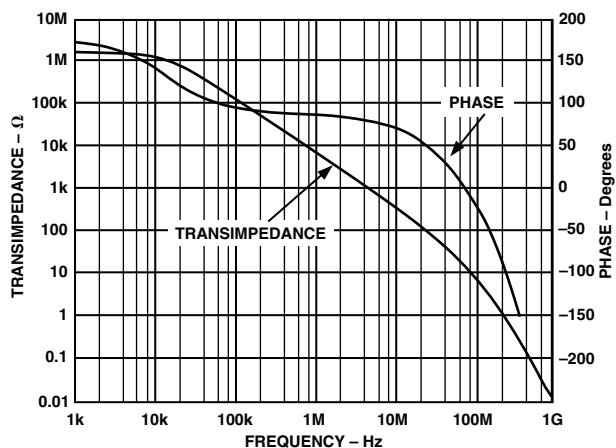

TPC 23. Open Loop Transimpedance and Phase

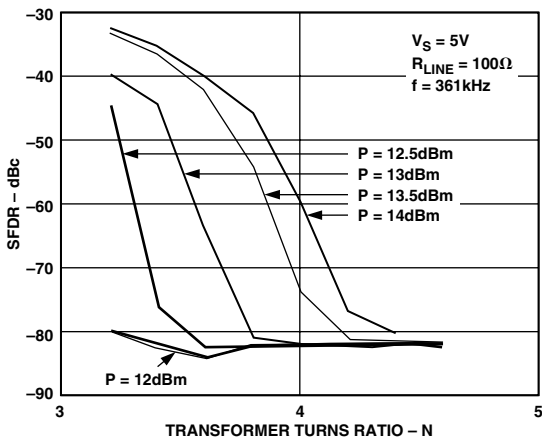

TPC 21. Out-of-Band SFDR vs. Turns Ratio for Various Line Power

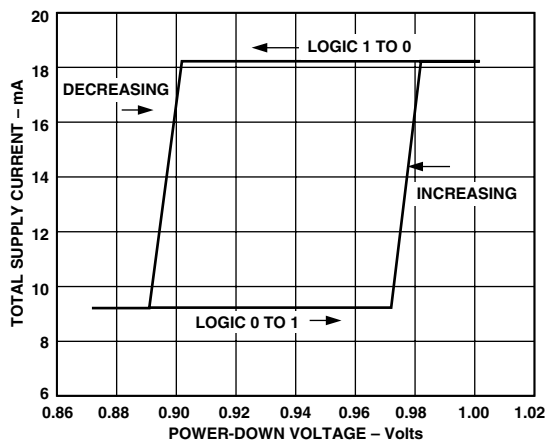

TPC 24. Power-Up/Down Threshold Voltage

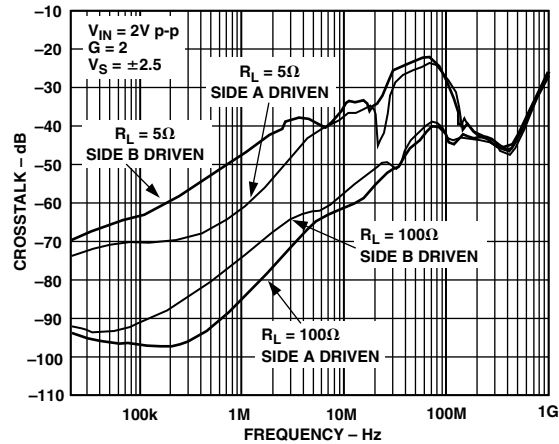

TPC 25. Crosstalk vs. Frequency

THEORY OF OPERATION

The AD8018 is composed of two current feedback amplifiers capable of delivering 400 mA of output current while swinging to within 0.5 V of either power supply, and maintaining low distortion. A differential line driver using the AD8018 can provide CPE performance on a single 5 V supply. This performance is enabled by Analog Device's XFCB process and a novel, two-stage current feedback architecture featuring a patent-pending rail-to-rail output stage.

A simplified schematic is shown in Figure 4. Emitter followers buffer the positive input, V_P , to provide low input current and current noise. The low impedance current feedback summing junction is at the negative input, V_N . The output stage is another high-gain amplifier used as an integrator to provide frequency compensation. The complementary common-emitter output provides the extended output swing.

A current feedback amplifier's dynamic and distortion performance is relatively insensitive to its closed-loop signal gain, which is a distinct advantage over a voltage-feedback architecture. Figure 5 shows a simplified model of a current feedback amplifier. The feedback signal is a current into the inverting node. R_{IN} is inversely proportional to the transconductance of the amplifier's input stage, g_{mi} . Circuit analysis of the pictured follower with gain yields:

$$V_{OUT}/V_{IN} = G \times \frac{T_{Z(S)}}{T_{Z(S)} + R_F + G \times R_{IN}}$$

where:

$$G = 1 + R_F/R_G$$

$$T_{Z(S)} = \frac{R_T}{1 + sC_T(R_T)}$$

$$R_{IN} = 1/g_{mi} \cong 125 \Omega$$

Recognizing that $G \times R_{IN} < R_F$, and that the -3 dB point is set when $T_{Z(S)} = R_F$, one can see that the amplifier's bandwidth depends primarily on the feedback resistor. There is a value of R_F below which the amplifier will be unstable, as an actual amplifier will have additional poles that will contribute excess phase shift. The optimum value for R_F depends on the gain and the amount of peaking tolerable in the application.

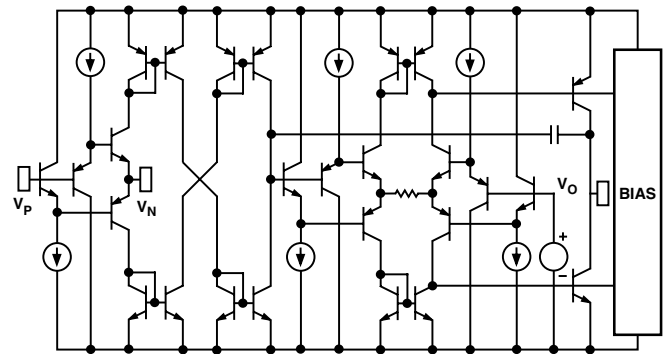

Figure 4. Simplified Schematic

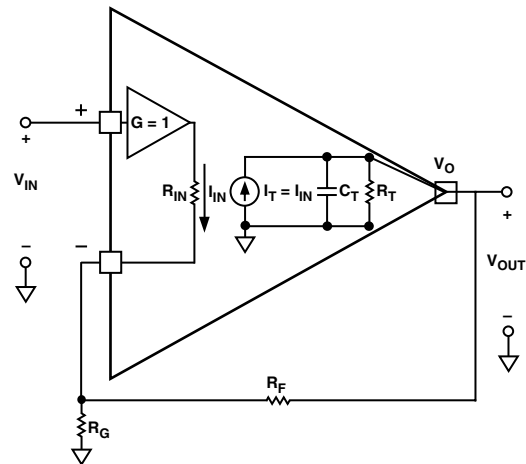

Figure 5. Model of Current Feedback Amplifier

FEEDBACK RESISTOR SELECTION

In current feedback amplifiers, selection of the feedback and gain resistors will impact the MTPR performance, bandwidth, noise, and gain flatness. Care should be exercised in the selection of these resistors so that the optimum performance is achieved. Table I shows the recommended resistor values for use in a variety of gain settings for the test circuit in TPC 1. These values are intended to be a starting point when designing for any application.

Table I. Resistor Selection Guide

Gain	R_F (Ω)	R_G (Ω)
-1	681	681
+1	1 k	∞
+2	750	750
+3	511	256
+4	340	113
+5	230	59

POWER-DOWN FEATURES

Two digitally programmable logic pins, PWDN1 and PWDN0, are available on the TSSOP-14 package to select among three different modes of operation, full power, standby and shutdown. The DGND pin is the logic ground reference. The logic threshold voltage is established 1 V above DGND. In a typical 5 V single-supply application, the DGND pin is connected to analog ground. If PWDN1, PWDN0, and DGND are left unconnected, the AD8018 will operate at full power.

Table II. Power-Down Features and Truth Table

PWDN0	PWDN1	State	Supply Current	Output Impedance
High	High	Full Power	18 mA	Low
Low	High	Standby	9 mA	Low
High	Low	Standby	9 mA	Low
Low	Low	Disabled	300 μ A	High

POWER SUPPLY AND DECOUPLING

The AD8018 can be powered with a good quality (i.e., low-noise) supply anywhere in the range from 3.3 V to 8 V. However, in order to optimize the ADSL upstream drive capability to +13 dBm and maintain the best Spurious Free Dynamic Range (SFDR), the AD8018 circuit should be supplied with a well regulated 5 V supply. The 5 V supplied at the Universal Serial Bus (USB) port may be poorly regulated. Improving the quality of the 5 V supply will optimize the performance of the AD8018 in a Universal Serial Bus-supplied CPE ADSL modem. This can be accomplished through the use of a step-up dc-to-dc converter or switching power supply followed by a low dropout (LDO) regulator such as the ADP3331 (see Figure 6). Setting R_1 to be 953 k Ω and R_2 to be 301 k Ω will result in a V_{OUT} of 5 V.

Careful attention must be paid to decoupling the power supply pins at the output of the dc-to-dc converter, the output of the LDO regulator and the supply pins of the AD8018. High-quality capacitors with low equivalent series resistance (ESR) such as multilayer ceramic capacitors (MLCCs) should be used to minimize supply voltage ripple and power dissipation. A large, usually tantalum, 10 μ F to 47 μ F capacitor located in proximity to the AD8018 is required to provide good decoupling for lower frequency signals. In addition, 0.1 μ F MLCC decoupling capacitors should be located as close to each of the power supply pins as is physically possible, no more than 1/8 inch away. An additional large (4.7 μ F to 10 μ F) tantalum capacitor should be placed on the board near the supply terminals to supply current for fast, large-signal changes at the AD8018 outputs.

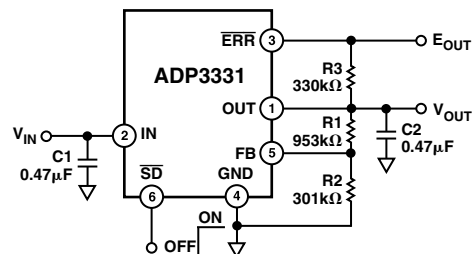

Figure 6. ADP3331 LDO

METHOD FOR GENERATING A MIDSUPPLY VOLTAGE

To operate an amplifier on a single voltage supply, a voltage midway between the supply and ground must be generated to properly bias the inputs and the outputs.

A voltage divider can be created with two equal value resistors (Figure 7). There is a trade-off between the power consumed by the divider and the voltage drop across these resistors due to the positive input bias currents. Selecting 2.5 k Ω for R_1 and R_2 will create a voltage divider that draws only 1 mA from a 5 V supply. The voltage generated with this topology can vary due to the temperature coefficient (TC) of resistance. Resistors that are closely matched and have a low TC will minimize variations in the voltage reference due to temperature. One should also be sure to use a decoupling capacitor (0.1 μ F) at the node where V_{REF} is generated.

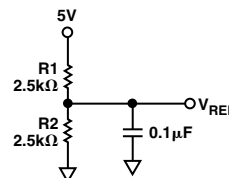

Figure 7. Midsupply Reference

DIFFERENTIAL TESTING

The test circuit shown in TPC 13 is used for measuring the differential distortion of the AD8018. A single-ended test signal is applied to the inverting input of the AD8138 differential driver with the noninverting input grounded. Applying the differential output of the AD8138 through 100 Ω resistors serves to isolate the inputs of the AD8018 differential driver and provide a well-balanced low-distortion input signal. The differential load (R_L) of the AD8018 can be set to the equivalent of the line impedance reflected through a transformer. The AD9632 converts the differential output voltage back to a single-ended signal. The differential-to-single-ended converter using the AD9632 has an attenuation of -26 dB and is wired with precision resistors to optimize the balance of differential input signal. The resulting smaller output signal can be easily measured using a 50 Ω spectrum analyzer.

AD8018

This circuit requires significant power supply bypassing. The AD8018 operates on a split supply in this circuit. The bypassing technique shown in TPC 13 utilizes a 220 μF tantalum capacitor and a 0.1 μF ceramic chip capacitor in parallel, connected from the positive to negative supply, and a 10 μF tantalum and 0.1 μF ceramic chip capacitor in parallel, connected from each supply to ground. The capacitors connected between the power supplies serve to minimize any voltage ripples that might appear at the supplies while sourcing or sinking any large differential current. The large capacitor has a pool of charge instantly available for the AD8018 to draw from, thus preventing any erroneous distortion results.

POWER DISSIPATION

It is important to consider the total power dissipation of the AD8018 in order to properly size the heat sink area of an application. Figure 8 is a simple representation of a differential driver. With some simplifying assumptions we can estimate the total power dissipated in this circuit. If the output current is large compared to the quiescent current, computing the dissipation in the output devices and adding it to the quiescent power dissipation will give a close approximation of the total power dissipation in the package. A factor α (~ 0.6 - 1) corrects for the slight error due to the Class A/B operation of the output stage. It can be estimated by subtracting the quiescent current in the output stage from the total quiescent current and ratioing that to the total quiescent current. For the AD8018, $\alpha = 0.833$.

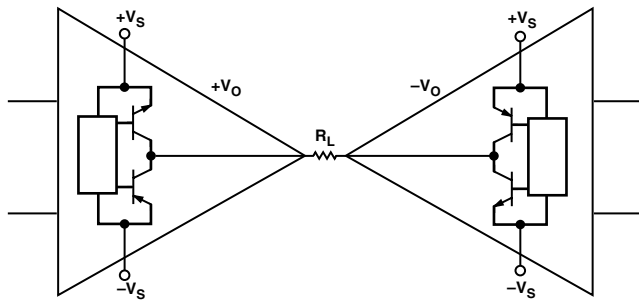

Figure 8. Simplified Differential Driver

Remembering that each output device dissipates for only half the time gives a simple integral that computes the power for each device:

$$\frac{1}{2} \int \left[(V_S - V_O) \times \frac{2V_O}{R_L} \right]$$

The total supply power can then be computed as:

$$P_{TOT} = 4 \left(V_S \int |V_O| - \int V_O^2 \right) \times \frac{1}{R_L} + 2 \alpha I_Q V_S + P_{OUT}$$

In this differential driver, V_O is the voltage at the output of one amplifier, so $2 V_O$ is the voltage across R_L , which is the total impedance seen by the differential driver, including back termination. Now, with two observations, the integrals are easily evaluated. First, the integral of V_O^2 is simply the square of the rms value of V_O . Second, the integral of $|V_O|$ is equal to the average rectified value of V_O , sometimes called the Mean Average Deviation, or MAD. It can be shown that for a Discrete MultiTone (DMT) signal, the MAD value is equal to 0.8 times the rms value.

$$P_{TOT} = 4 (0.8 V_O \text{ rms } V_S - V_O \text{ rms}^2) \times \frac{1}{R_L} + 2 \alpha I_Q V_S + P_{OUT}$$

For the AD8018, operating on a single 5 V supply and delivering a total of 16 dBm (13 dBm to the line and 3 dBm to the matching network) into 12.5 Ω (100 Ω reflected back through a 1:4.0 transformer plus back termination), the power is:

$$\begin{aligned} &= 261 \text{ mW} + 40 \text{ mW} \\ &= 301 \text{ mW} \end{aligned}$$

Using these calculations, and a θ_{JA} of 115°C/W for the TSSOP package and 100°C/W for the SOIC, Tables III and IV show junction temperature versus power delivered to the line for several supply voltages.

Table III. Junction Temperature vs. Line Power and Operating Voltage for TSSOP, $T_{AMB} = 85^\circ\text{C}$

P _{LINE} , dBm	V _{SUPPLY}			
	5	6	7	8
13	115	122	129	136
14	117	125	132	140
15	119	127	136	144
16	121	130	139	148
17	123	133	143	153
18	125	136	147	158

Table IV. Junction Temperature vs. Line Power and Operating Voltage for SOIC, $T_{AMB} = 85^\circ\text{C}$

P _{LINE} , dBm	V _{SUPPLY}			
	5	6	7	8
13	111	117	123	129
14	113	119	126	133
15	115	122	129	136
16	116	124	132	140
17	118	127	136	144
18	120	130	139	149

Running the AD8018 at voltages near 8 V can produce junction temperatures that exceed the thermal rating of the TSSOP packages and should be avoided. The shaded areas indicate junction temperatures greater than 150°C.

LAYOUT CONSIDERATIONS

As is the case with all high-speed applications, careful attention to printed circuit board layout details will prevent associated board parasitics from becoming problematic. Proper RF design technique is mandatory. The PCB should have a ground plane covering all unused portions of the component side of the board to provide a low-impedance return path. Removing the ground plane on all layers from the area near the input and output pins will reduce stray capacitance, particularly in the area of the inverting inputs. Signal lines connecting the feedback and gain resistors should be as short as possible to minimize the inductance and stray capacitance associated with these traces. Termination resistors and loads should be located as close as possible to their respective inputs and outputs. Input and output traces should be kept as far apart as possible to minimize coupling (crosstalk) though the board. Adherence to stripline design techniques for long signal traces (greater than about 1 inch) is recommended.

Following these generic guidelines will improve the performance of the AD8018 in all applications.

To optimize the AD8018's performance as an ADSL differential line driver, locate the transformer hybrid near the AD8018 drivers and as close to the RJ11 jack as possible. Maintain differential circuit symmetry into the differential driver and from the output of the drivers through the transformer-coupled output of the bridge circuit as much as possible.

CPE ADSL Application

The low-cost, high-output current dual AD8018 xDSL driver amplifiers have been specifically designed to drive high fidelity xDSL signals to within 0.5 V of the power rails, the performance needed to provide CPE ADSL on a single 5 V supply. The AD8018 may be used in transformer-coupled bridge hybrid circuits to drive modulated signals including Discrete MultiTone (DMT) upstream to the central office.

Evaluation Board

The AD8018ARU-EVAL evaluation board circuit in Figure 12 offers the ability to evaluate the AD8018 in a typical xDSL bridge hybrid circuit.

The receiver circuit on these boards is typically unpopulated. Requesting samples of the AD8022AR with the AD8018ARU-EVAL board will provide the capability to evaluate the AD8018ARU along with other Analog Devices products in a typical transceiver circuit. The evaluation circuits have been designed to replicate the CPE side analog transceiver hybrid circuits.

The circuit mentioned above is designed using a one-transformer transceiver topology including a line receiver, line driver, line matching network, an RJ11 jack for interfacing to line simulators, and transformer-coupled inputs for single-ended-to-differential input conversion.

AC-coupling capacitors of 0.01 μ F, C8, and C10, in combination with 10 k Ω resistors R24 and R25, will form a zero frequency at 1.6 kHz.

Transformer Selection

Customer premise ADSL requires the transmission of a +13 dBm (20 mW) DMT signal. The DMT signal can have a crest factor as high as 5.3, requiring the line driver to provide peak line power of 27.5 dBm (560 mW). 27.5 dBm peak line power translates into a 7.5 V peak voltage on the 100 Ω telephone line. Assuming that the maximum low-distortion output swing available from the AD8018 line driver on a 5 V supply is 4 V and, taking into account the power lost due to the termination resistance, a step-up transformer with turns ratio of 4.0 or greater is needed.

In the simplified differential drive circuit shown in Figure 2, the AD8018 is coupled to the phone line through a step-up transformer with a 1:4 turns ratio. R1 and R2 are back-termination or line-matching resistors, each 3.1 Ω (100 Ω /(2 \times 4²)), where 100 Ω is the approximate phone line impedance. The total differential load for the AD8018, including the termination resistors, is 12.5 Ω . Even under these conditions the AD8018 provides low distortion signals to within 0.5 V of the power rails.

Stability Enhancements

The CPE bridge hybrid circuit presents a complex impedance to the drive amplifiers, particularly when transformer parasitics are factored in. To ensure stable operation under the full range of load conditions, a series R-C network (Zoebel Network) should be connected between each amplifier's output and ground. The recommended values are 10 Ω for the resistor and 1 nF for the capacitor to create a low impedance path to ground at frequencies above 16 MHz (see Figure 2). R33 and R34 are added to improve common-mode stability.

Receive Channel Considerations

A transformer used at the output of the differential line driver to step up the differential output voltage to the line has the inverse effect on signals received from the line. A voltage reduction or attenuation equal to the inverse of the turns ratio is realized in the receive channel of a typical bridge hybrid. The turns ratio of the transformer may also be dictated by the ability of the receive circuitry to resolve low-level signals in the noisy twisted pair telephone plant. Higher turns ratio transformers effectively reduce the received signal-to-noise ratio due to the reduction in the received signal strength.

The AD8022, a dual amplifier with typical RTI voltage noise of only 2.5 nV/ $\sqrt{\text{Hz}}$ and a low supply current of 4 mA/amplifier, is recommended for the receive channel.

DMT Modulation, MultiTone Power Ratio (MTPR), and Out-of-Band SFDR

ADSL systems rely on DMT modulation to carry digital data over phone lines. DMT modulation appears in the frequency domain as power contained in several individual frequency subbands, sometimes referred to as tones or bins, each of which is uniformly separated in frequency. A uniquely encoded, Quadrature Amplitude Modulation (QAM)-like signal occurs at the center frequency of each subband or tone. See Figure 9 for an example of a DMT waveform in the frequency domain, and Figure 10 for a time domain waveform. Difficulties will exist when decoding these subbands if a QAM signal from one subband is corrupted by the QAM signal(s) from other subbands, regardless of whether the corruption comes from an adjacent subband or harmonics of other subbands.

Conventional methods of expressing the output signal integrity of line drivers, such as single-tone harmonic distortion or THD, two-tone InterModulation Distortion (IMD), and third order intercept (IP3), become significantly less meaningful when amplifiers are required to process DMT and other heavily modulated waveforms. A typical ADSL upstream DMT signal can contain as many as 27 carriers (subbands or tones) of QAM signals. MultiTone Power Ratio (MTPR) is the relative difference between the measured power in a typical subband (at one tone or carrier) versus the power at another subband specifically selected to contain no QAM data. In other words, a selected subband (or tone) remains open or void of intentional power (without a QAM signal), yielding an empty frequency bin. MTPR, sometimes referred to as the "empty bin test," is typically expressed in dBc, similar to expressing the relative difference between single-tone fundamentals and second or third harmonic distortion components. Measurements of MTPR are typically made on the line side or secondary side of the transformer.

AD8018

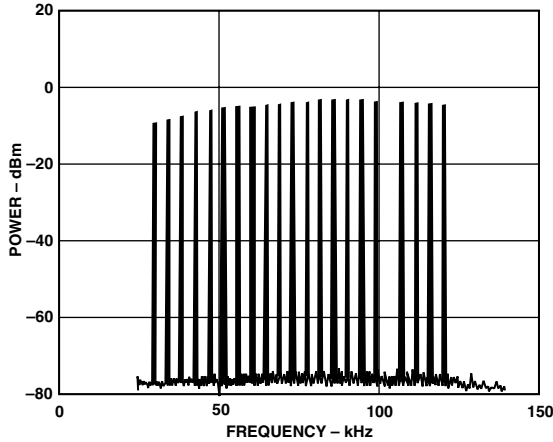

Figure 9. DMT Waveform in the Frequency Domain

MTPR versus transformer turns ratio is depicted in TPC 21 and covers a variety of line power ranging from +12 dBm to +14 dBm. As the turns ratio increases, the driver hybrid can deliver more undistorted power due to higher output current capability. Significant degradation of MTPR will occur if the output of the driver swings to the rails, causing clipping at the DMT voltage peaks. Driving DMT signals to such extremes not only compromises “in-band” MTPR, but will also produce spurs that exist outside of the frequency spectrum containing the desired DMT power. “Out-of-band” spurious free dynamic range (SFDR) can be defined as the relative difference in amplitude between these spurs and a tone in one of the upstream bins. Compromising out-of-band SFDR is equivalent to increasing near end crosstalk (NEXT). Regardless of terminology, maintaining out-of-band SFDR while reducing NEXT will improve the overall performance of the modems connected at either end of the twisted pair.

TPC 21 shows how SFDR varies versus transformer turns ratio for line power ranging from +12 dBm to +14 dBm. As line power increases, or turns ratio decreases, SFDR degrades. The power contained in the spurs can be measured relative to the power contained in a typical upstream carrier and is expressed in dBc as SFDR, similar to MTPR.

The supply voltage of the driver can also affect SFDR. As the supply voltage is increased, voltage swing is increased as well, resulting in the ability to deliver more power to the line without sacrificing performance. This can be seen in TPC 22. Less undistorted power is available when lower turns ratio transformers are used due to voltage clipping of the signal.

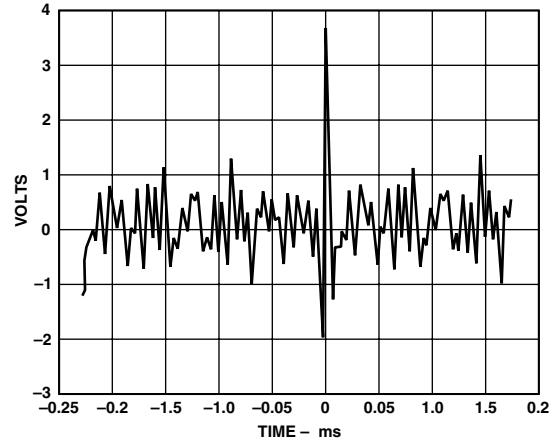

Figure 10. DMT Signal in the Time Domain

Generating DMT Signals

At this time, DMT-modulated waveforms are not typically menu-selectable items contained within AWGs. Even using AWG software to generate DMT signals, AWGs that are available today may not deliver DMT signals sufficient in performance with regard to MTPR due to limitations in the D/A converters and output drivers used by AWG manufacturers. Similar to evaluating single-tone distortion performance of an amplifier, MTPR evaluation requires a DMT signal generator capable of delivering MTPR performance better than that of the driver under evaluation. Generating DMT signals can be accomplished using a Tektronics AWG 2021 equipped with Option 4, (12-/24-bit, TTL Digital Data Out), digitally coupled to Analog Devices’ AD9754, a 14-bit TxDAC®, buffered by an AD8002 amplifier configured as a differential driver. Note that the DMT waveforms (available on the Analog Devices website, <http://www.analog.com>), or similar .WFM files are needed to produce the digital data required to drive the TxDAC from the optional TTL Digital Data output of the TEK AWG2021.

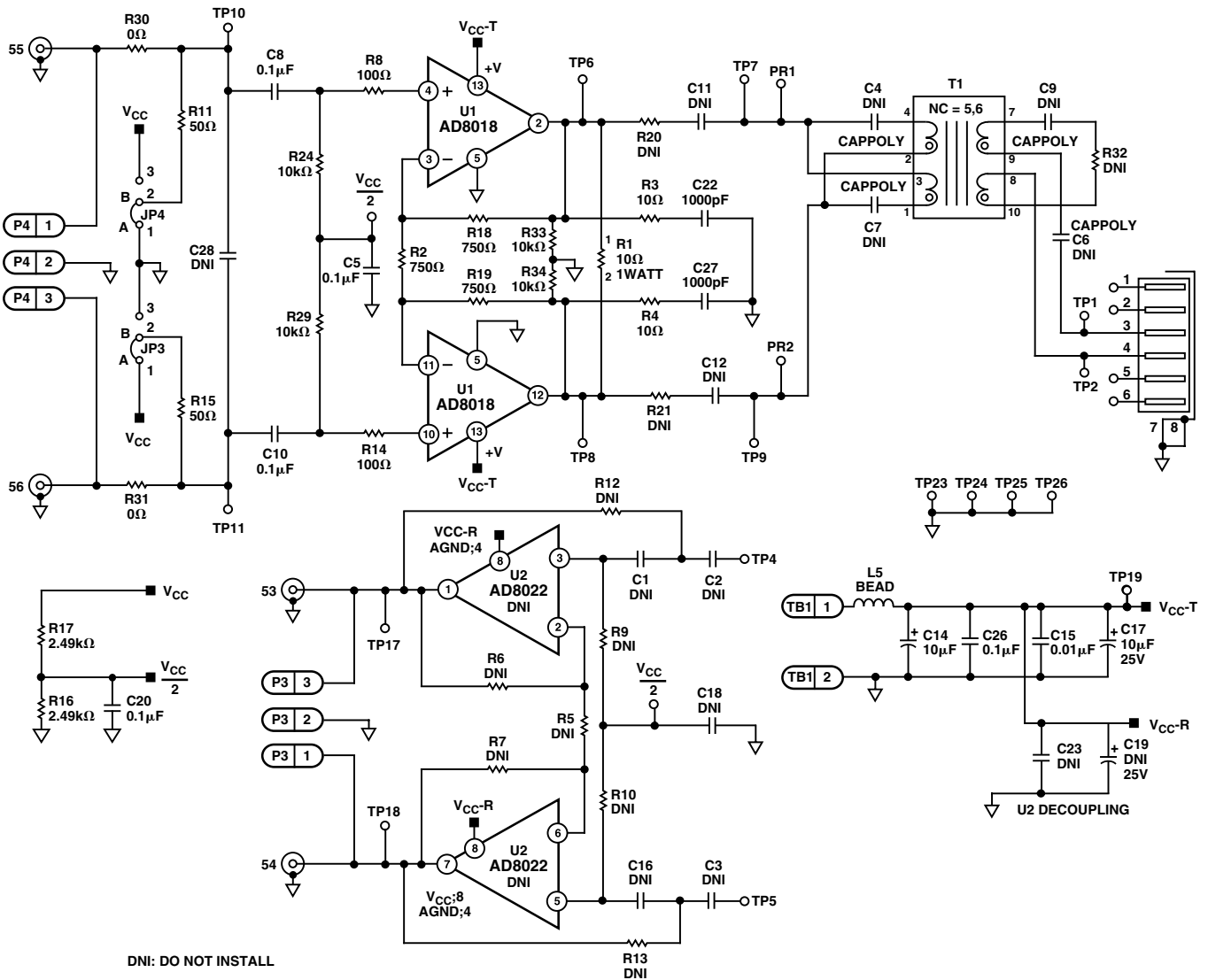

Figure 11. EVAL Board Schematic

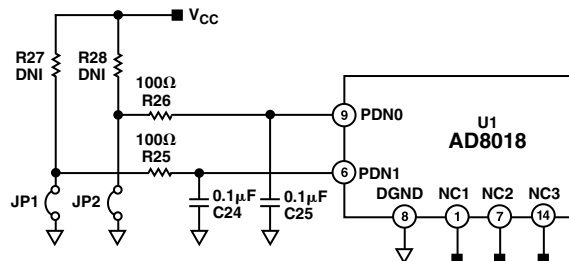

Figure 12. Input Control Circuit

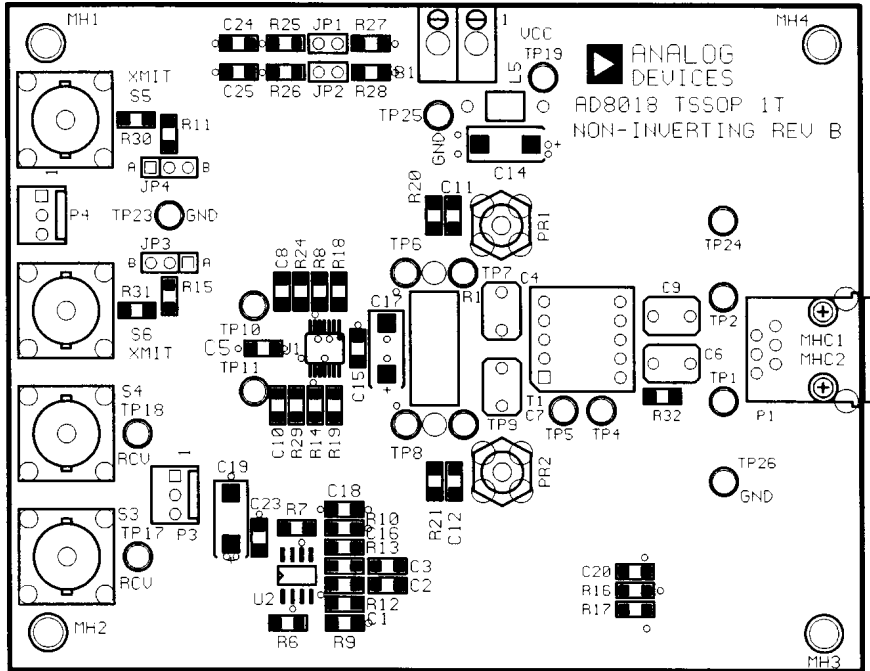

Figure 13. Assembly—Primary Side

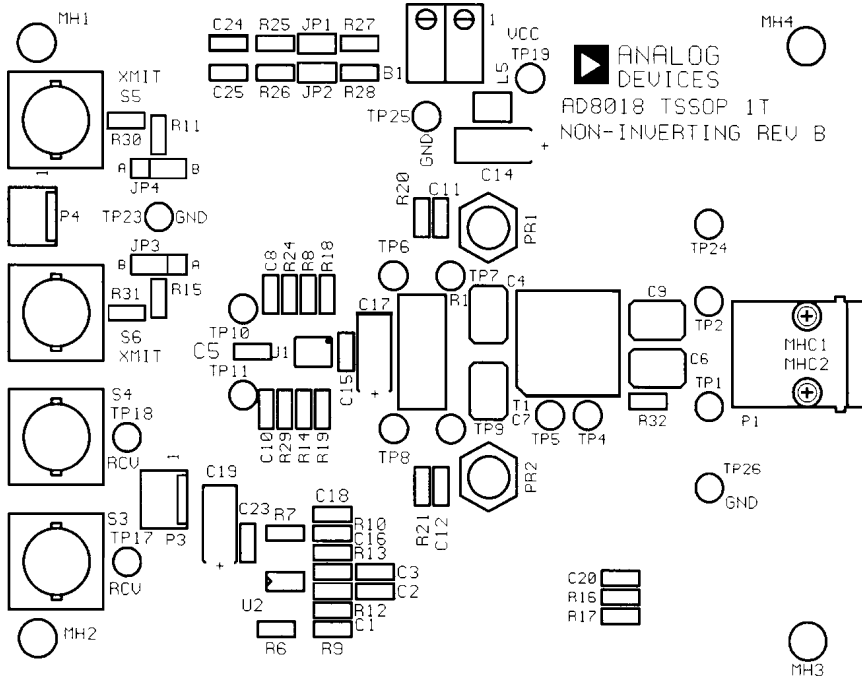

Figure 14. Silk Screen—Primary Side

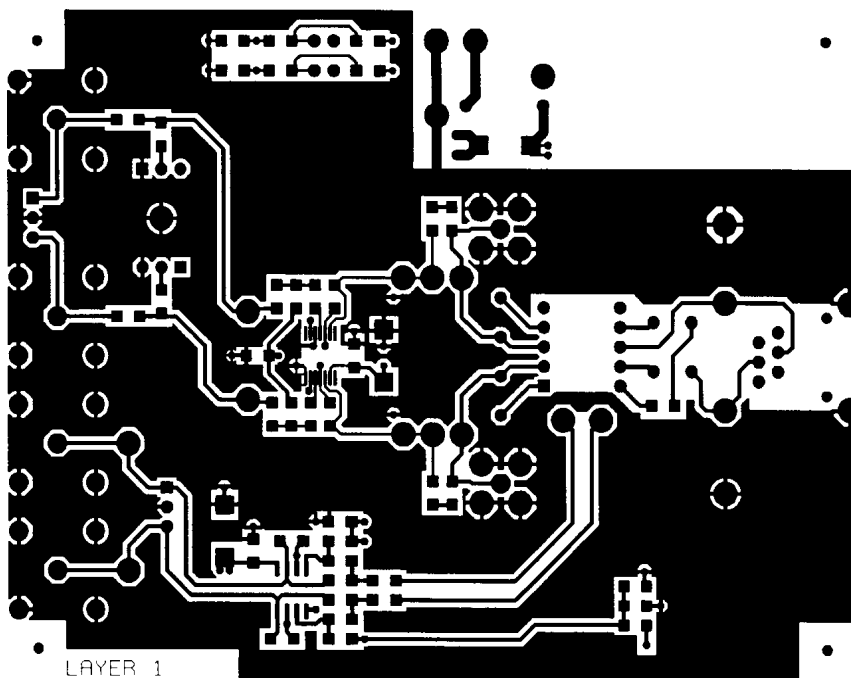

Figure 15. Layer 1—Primary Side

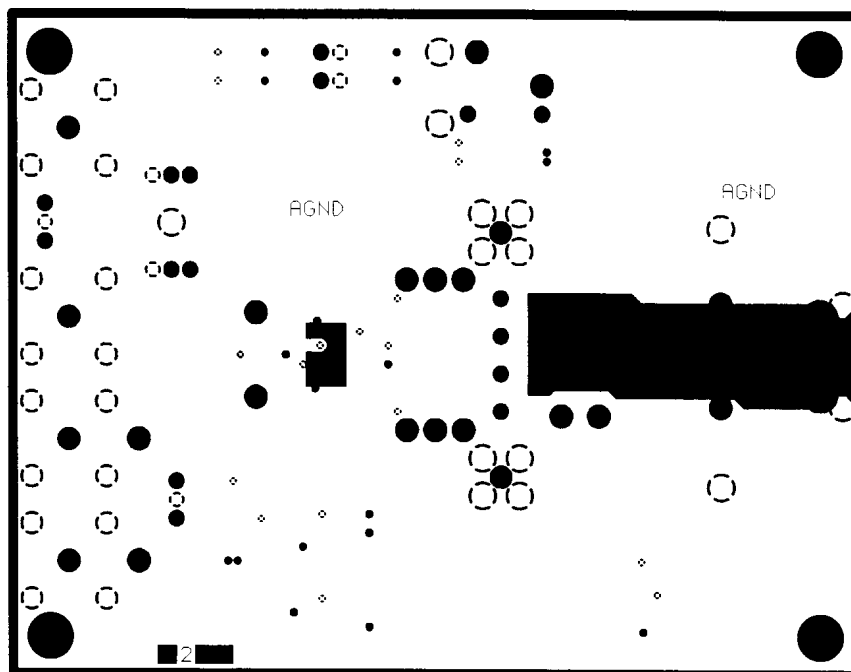

Figure 16. Layer 2—Ground Plane

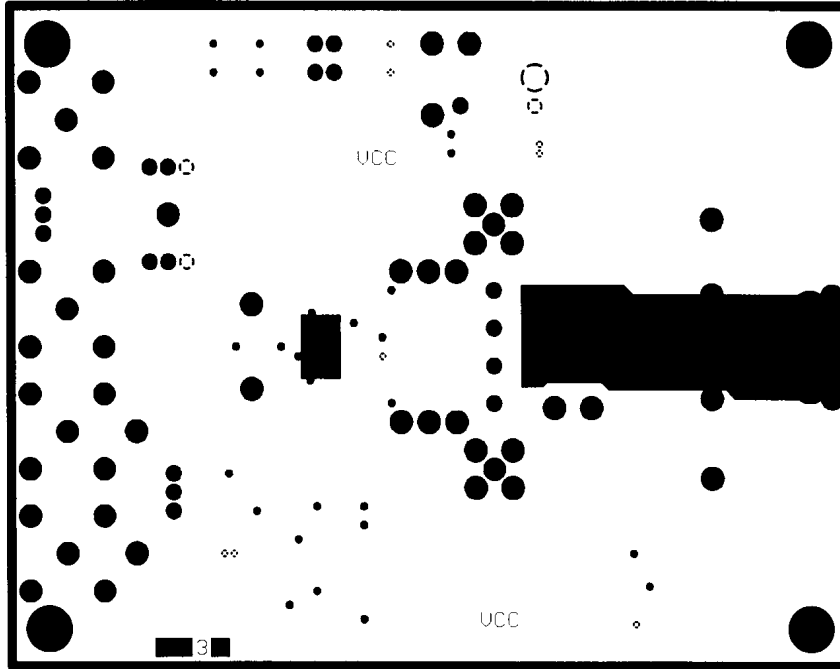

Figure 17. Layer 3—Power Plane

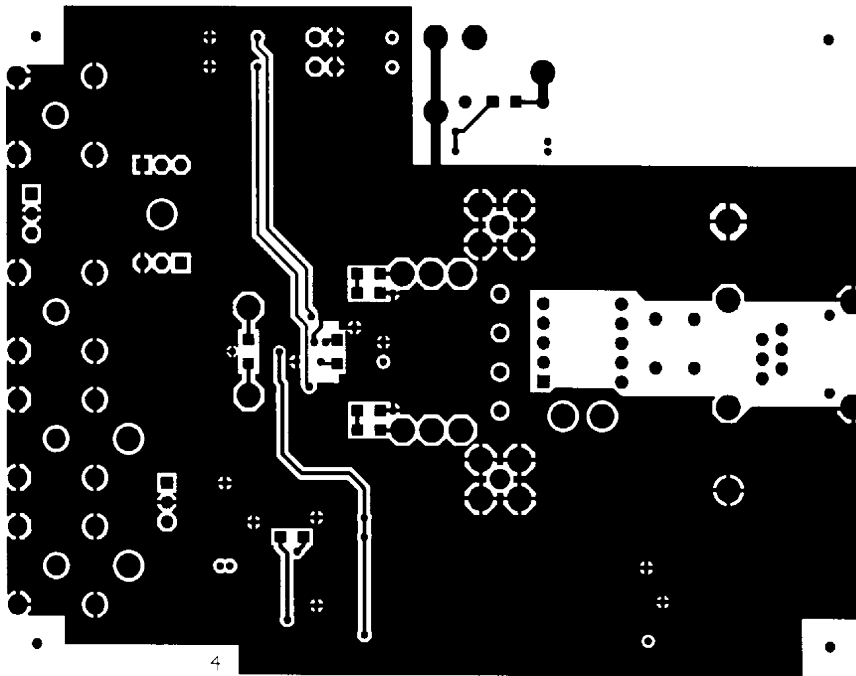

Figure 18. Layer 4—Secondary Side

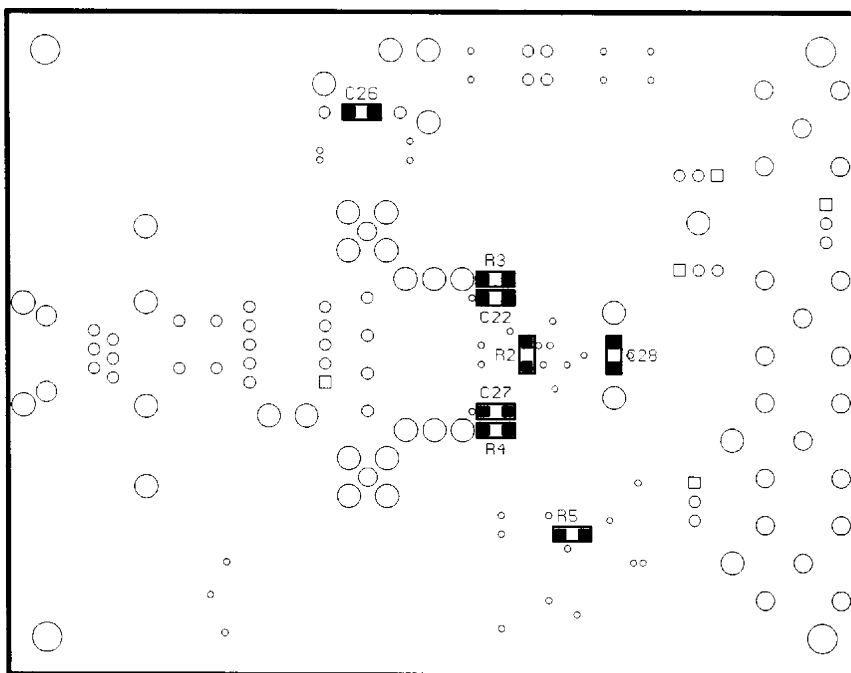

Figure 19. Assembly—Secondary Side

AD8018

EVALUATION BOARD—BILL OF MATERIALS

Qty.	Description	Vendor	Ref Desc.
2	1,000 pF 50 V. 1206 ceramic chip capacitor	ADS # 4-5-20	C22, 27
2	0.01 μ F 50 V. 1206 ceramic chip capacitor	ADS # 4-5-19	C15, 23
5	0.1 μ F 50 V. 1206 size ceramic chip capacitor	ADS # 4-5-18	C5, 20, 24 -26
2	1.0 μ F 16 V. 1206 size ceramic chip capacitor	Newark # 83F6841	C8, 10
4	# 26 red (solid) wire jumper	ADS # 10-14-3	C4, 6, 7, 9
3	10 μ F 16 V. 'C' size Tantalum chip capacitor	ADS # 4-7-6	C14, 17, 19
1	Ferrite bead (with # 22 wire)	ADS # 48-1-1	L5
1	10 Ω 5% 3.0 W. metal oxide power resistor	D-K # P10W-3BK-ND	R1
6	0 Ω 5% 1/8 W. 1206 size chip resistor	ADS # 3-18-88	C11, 12, R20, 21, 30, 31
2	10.0 Ω 1% 1/8 W. 1206 size chip resistor	ADS # 3-18-120	R3, 4
2	49.9 Ω 1% 1/8 W. 1206 size chip resistor	ADS # 3-14-26	R11, 15
5	100 Ω 1% 1/8 W. 1206 size chip resistor	ADS # 3-18-40	R8, 14, 25, 26, 32
2	2.49 k Ω 1% 1/8 W. 1206 size chip resistor	ADS # 3-18-71	R16, 17
3	750 Ω 1% 1/8 W. 1206 size chip resistor	ADS # 3-18-8	R2, 18, 19
2	10.0 k Ω 0.1% 0805 size chip resistor	ADS # 3-36-5	R33, 34
2	10.0 k Ω 1% 1/8 W. 1206 size chip resistor	ADS # 3-18-119	R24 and 29
4	Test Point (Black) [GND]	ADS # 12-18-44	TP23-26 (GND.)
2	Test Point (Brown)	ADS # 12-18-59	TP4, 5
3	Test Point (Red)	ADS # 12-18-43	TP17-19
4	Test Point (Orange)	ADS # 12-18-60	TP1, 2, 10, 11
1	Test Point (Yellow)	ADS # 12-18-32	TP3
2	Test Point (Blue)	ADS # 12-18-62	TP6, 8
2	Test Point (Green)	ADS # 12-18-61	TP7, 9
1	2 \times 5-pin strips (1/4 of a 20-pin Samtek 'SIP' strip socket)	ADS # 11-2-14	(T1)
1	2 Pos. GRAY term. blk. # 25.161.0253 (Newark # 51F4106)	ADS# 12-19-10	TB1, 2
4	0.1 inch ctr. shunt Berg # 65474 -001	ADS # 11-2-38	JP1-4
2	2 pin gold male header 0.1 inch ctr. Berg # 69157 -102	ADS # 11-2-37	JP1, 2
4	50 Ω BNC pc mount Telegartner # J01001A1944	ADS # 12-6-22	S3-6
1	AMP# 555154 -1 MOD. JACK (SHIELDED) 6 -6	ADS # 12-20-5	P1
2	3-pin gold male header Waldom D-K # WM 2723 -ND	ADS # 12-3-80	JP3, 4
2	3-pin gold male locking header Waldom # WM 2701 -ND	ADS # 12-3-79	P3, 4
1	AD8018ARU ADSL Driver hybrid	ADS # AD8018ARU	U1 (D.U.T.)
1	AD8018 TSSOP1T Non-Inverting REV. A Evaluation PC board	D C S	Eval. PC Board
4	# 4 -40 \times 1/4" panhead ss machine screw	ADS # 30-1-1	
4	# 4 -40 \times 1/2" threaded alum. standoffs	ADS # 30-16-2	

OUTLINE DIMENSIONS

Dimensions shown in inches and (mm).

8 Lead SOIC
(SO-8)

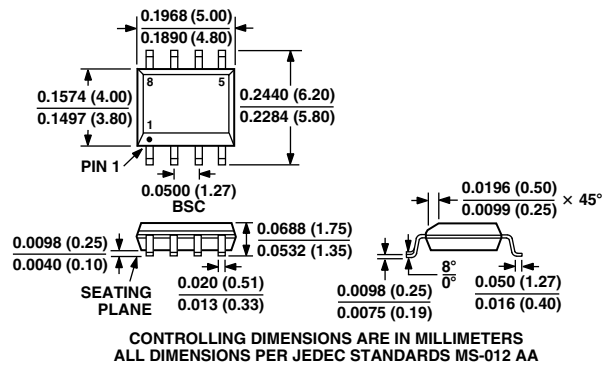

14 Lead TSSOP
(RU-14)

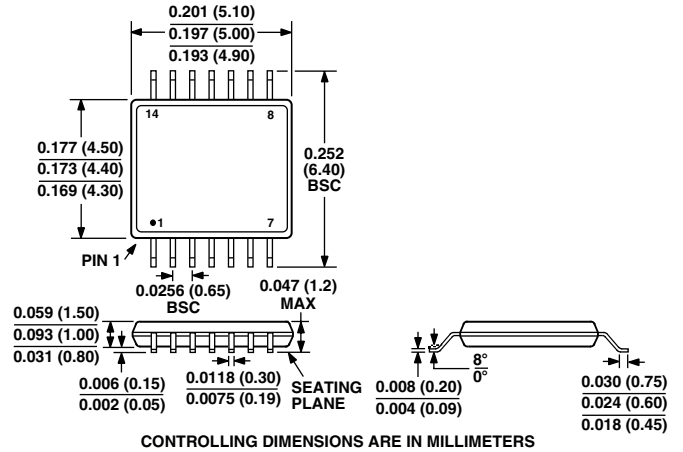

C01519a-5-11/00 (rev. A)

PRINTED IN U.S.A.

Looking for pricing, stock, or lifecycle information?

Click below to explore more details on WIN SOURCE:

 [View AD8018ARZ-REEL7 on WIN SOURCE](#)

 [Analog Devices Inc. Information](#)

Optimize Your Supply Chain with WIN SOURCE Solutions

-  Global Sourcing Solution
-  Obsolete Management
-  Cost Control Management
-  Shortage Management
-  Alternative Solution
-  Excess Inventory Management