

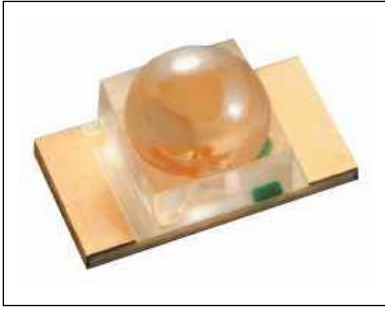

**THE DATASHEET OF
VFR1105W-TR**





**Pb-free
HEAT**



1105W Series

Single Color Dome Lens Type
(High Reliability type, V-Series)

Product features

Package	3216 fixed lens type, Water clear epoxy
Product features	<ul style="list-style-type: none"> • Outer Dimension 3.2 x 1.6 x 1.85mm(L x W x H) • Wide operation temperature range. Storage Temperature : InGaN : -40°C~110°C : AlGaInP : -40°C~120°C Operating Temperature : -40°C~100°C Operation Guarantee • Ramification of luminosity group sorting. It is possible to have a uniform transmission with little irregularities even when several are lined up. • Systematization of luminosity groups and color tone groups. Unified to a simple standard. • Corresponding to a use requiring high reliability in cars etc... • Surface Mount Type and Reverse Mount Type are possible. • Shape resin into a lens to make high luminosity possible. • Lead-free soldering compatible • RoHS compliant
Dominant wavelength	Blue : 470nm (VUB) Green : 530nm (VUG) , 562nm(VYBG) Yellow Green : 572nm (VYPY) Yellow : 590nm (VFY) Orange : 605nm (VFA) Red : 615nm (VFV) , 626nm (VFR)
Spatial distribution	VUB,VUG : 20deg. VYBG,VYPY,VFY,VFA,VFV,VFR : 40 deg.
Die materials	VUB,VUG : InGaN VYBG, VYPY, VFY, VFA, VFV, VFR :AlGaInP
Optical efficiency	VUB : 10.9lm/W VUG : 23.6lm/W VYBG : 1.3lm/W VYPY : 4.8lm/W VFY : 11.8lm/W VFA : 11.8lm/W VFV : 13.2lm/W VFR : 11.8lm/W
Rank grouping parameter	Sorted by luminous intensity and wavelength and taped according to rank.
Assembly methods (customer)	Corresponding to surface mounter.
Soldering methods	Corresponding to reflow soldering and manual soldering.
Taping dimensions	2,000pcs(standard) per reel in a 8mm width tape. Reel diameter : ϕ 180mm
ESD	AlGaInP:2kV (HBM) InGaN:1kV (HBM)

Recommended Applications

SW lighting for car indicators, meter panel, car audio and heater control, etc...

Color Variations and Luminous Intensity

(Ta=25°C)

Part No.	Material	Emitted Color	Lens Color	Dominant Wavelength		Luminous Intensity			Luminous Flux	
				λd (nm)		I_v (mcd)			ϕv (mlm)	
				TYP.	I_F	MIN.	MAX.	I_F	TYP.	I_F
VUB1105W	InGaN	Blue	Water Clear	470	10	120	470	10	350	10
VUG1105W	InGaN	Green		530	10	560	2,200	10	780	10
VYBG1105W	AlGaInP			562	20	39	150	20	55	20
VYPY1105W	AlGaInP	Yellow Green		572	20	100	390	20	200	20
VFY1105W	AlGaInP	Yellow		590	20	330	1,200	20	450	20
VFA1105W	AlGaInP	Orange		605	20	330	1,200	20	450	20
VFV1105W	AlGaInP	Red		615	20	560	820	20	500	20
VFR1105W	AlGaInP			626	20	330	1,200	20	450	20

※Note : The luminous intensity(I_v) and dominant wavelength (λd) above are the setup values of the sorting machine.
 (Tolerance : I_v ... $\pm 10\%$, λd ... ± 1 nm)

Absolute Maximum Ratings

(Ta=25°C)

Item	Symbol	Absolute Maximum Ratings								Unit
		VUB	VUG	VYBG	VYPY	VFY	VFA	VFV	VFR	
Power Dissipation	P_d	84	84	81	81	78	78	78	78	mW
Forward Current	I_F	20	20	30	30	30	30	30	30	mA
Pulse Forward Current ※1	I_{FRM}	48	48	100	100	100	100	100	100	mA
Derating (Ta=75°C or higher)	ΔI_F	0.40※2	0.40※2	1.0	1.0	1.0	1.0	1.0	1.0	mA/°C
	ΔI_{FRM}	0.96※2	0.96※2	3.33	3.33	3.33	3.33	3.33	3.33	mA/°C
Reverse Voltage	V_R	5	5	5	5	5	5	5	5	V
Operating Temperature	T_{opr}	-40~+100								°C
Storage Temperature	T_{stg}	-40~+110		-40~+120						°C

※1 I_{FRM} Measurement condition : Pulse Width \leq 1ms., Duty \leq 1/20.

※2 Temperature Condition: Ta=60°C or higher.

Thermal Characteristics

Item	Symbol	Ratings								Unit
		VUB	VUG	VYBG	VYPY	VFY	VFA	VFV	VFR	
Junction Temperature (MAX.)	T_j	110	110	120	120	120	120	120	120	°C
Thermal Resistance (TYP.) (Junction/ ambient)	$R_{(th\ j-a)}$	600	600	700	650	650	650	650	650	°C/W
Thermal Resistance (TYP.) (Junction/ Solder Point)	$R_{(th\ j-s)}$	400	400	500	450	450	450	450	450	°C/W

※ $R_{(th\ j-a)}$ Measurement Condition / Substrate: FR4(t=1.6mm) Pattern Size: 16mm².

Electro-Optical Characteristics (VUB, VUG)

(Ta=25°C)

Item	Conditions	Symbol	Characteristic Ratings		Unit	
			VUB	VUG		
Forward Voltage	I _F =10mA	V _F	TYP.	3.3	3.3	V
			MAX.	3.8	3.8	
Reverse Current	V _R =5V	I _R	MAX.	100	100	μ A
Peak Wavelength	I _F =10mA	λ _p	TYP.	465	522	nm
Dominant Wavelength	I _F =10mA	λ _d	TYP.	470	530	nm
Spectral Line Half Width	I _F =10mA	Δλ	TYP.	26	35	nm
Half Intensity Angle	I _F =10mA	2θ 1/2	TYP.	20	20	deg.

※Note: The dominant wave length (λ_d) above is the setup value of the sorting machine.
(Tolerance : λ_d...±1nm)

Electro-Optical Characteristics (VYBG, VYPY, VFY, VFA, VFV, VFR)

(Ta=25°C)

Item	Conditions	Symbol	Characteristic Rating						Unit	
			VYBG	VYPY	VFY	VFA	VFV	VFR		
Forward Voltage	I _F =20mA	V _F	TYP.	2.1	2.1	1.9	1.9	1.9	1.9	V
			MAX.	2.5	2.5	2.4	2.4	2.4	2.4	
Reverse Current	V _R =5V	I _R	MAX.	100	100	100	100	100	100	μ A
Peak Wavelength	I _F =20mA	λ _p	TYP.	565	575	592	609	624	635	nm
Dominant Wavelength	I _F =20mA	λ _d	TYP.	562	572	590	605	615	626	nm
Spectral Line Half Width	I _F =20mA	Δλ	TYP.	15	15	15	15	15	15	nm
Half Intensity Angle	I _F =20mA	2θ 1/2	TYP.	40	40	40	40	40	40	deg.

※Note: The dominant wave length (λ_d) above is the setup value of the sorting machine.
(Tolerance : λ_d...±1nm)

Luminous Intensity Rank

(Ta=25°C)

Standard Chart(Unit: mcd)

Rank	I _v (mcd)		VUB	VUG	VYBG	VYPY	VFY	VFA	VFV	VFR
	MIN.	MAX.	I _F =10mA		I _F =20mA					
B5	22	27								
B6	27	33								
B7	33	39								
B8	39	47			B8					
B9	47	56								
BX	56	68								
BY	68	82								
BZ	82	100								
C1	100	120				C1				
C2	120	150	C2		C2					
C3	150	180								
C4	180	220								
C5	220	270								
C6	270	330								
C7	330	390				C7	C7	C7		C7
C8	390	470	C8							
C9	470	560								
CX	560	680		CX					CX	
CY	680	820								
CZ	820	1,000								
D1	1,000	1,200					D1	D1		D1
D2	1,200	1,500								
D3	1,500	1,800							D3	
D4	1,800	2,200		D4						
D5	2,200	2,700								
D6	2,700	3,300								
D7	3,300	3,900								
D8	3,900	4,700								
D9	4,700	5,600								

※Limited width of luminous intensity rank is from Min.4 rank width.

Color Tone Groups (λ d)

(Ta=25°C)

(unit: nm)

Tolerance: +/-1nm

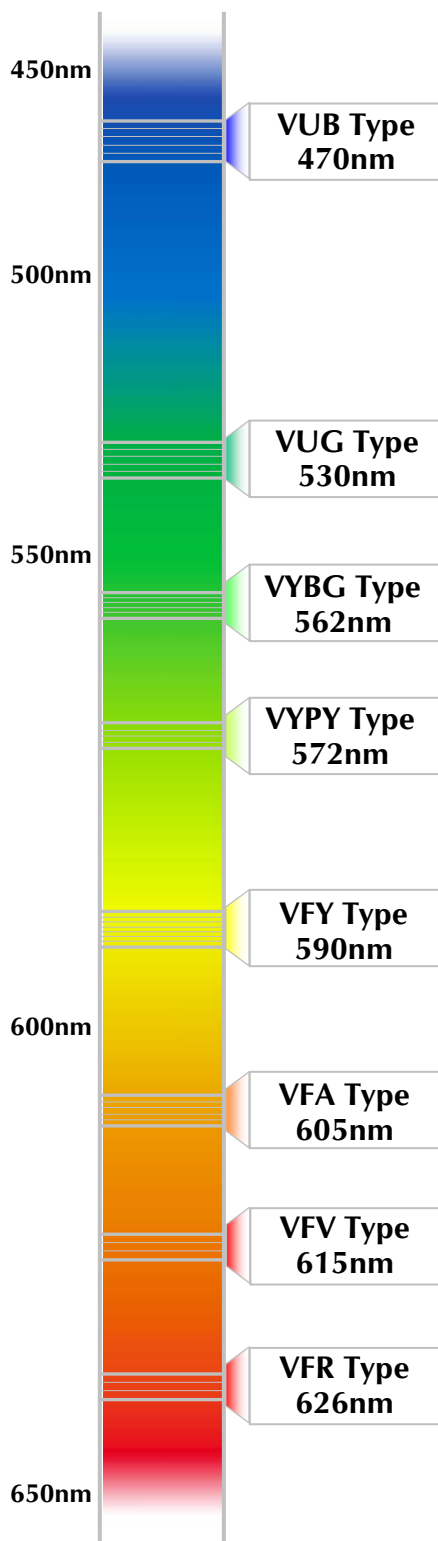

VUB Type (I_F=10mA)

	A	B	C	D
MIN.	460.0	464.0	468.0	472.0
MAX.	464.0	468.0	472.0	476.0

VUG Type (I_F=10mA)

	A	B	C	D
MIN.	515.0	520.0	525.0	530.0
MAX.	520.0	525.0	530.0	535.0

VYBG Type (I_F=20mA)

	B	C	D
MIN.	555.0	558.0	561.0
MAX.	558.0	561.0	564.0

VYPY Type (I_F=20mA)

	A	B	C
MIN.	567.0	570.0	573.0
MAX.	570.0	573.0	576.0

VFY Type (I_F=20mA)

	C	D	E	F
MIN.	583.0	586.0	589.0	592.0
MAX.	586.0	589.0	592.0	595.0

VFA Type (I_F=20mA)

	A	B	C	D
MIN.	597.0	600.0	603.0	606.0
MAX.	600.0	603.0	606.0	609.0

VFV Type (I_F=20mA)

	B	C	D
MIN.	613.0	616.0	619.0
MAX.	616.0	619.0	622.0

VFR Type (I_F=20mA)

	A	B	C
MIN.	620.0	626.0	632.0
MAX.	626.0	632.0	638.0

※Limited width of color tone rank is from Min.3 to Min.4 rank width.
(It changes with product.)

Characteristics Chart (VUB,VUG)

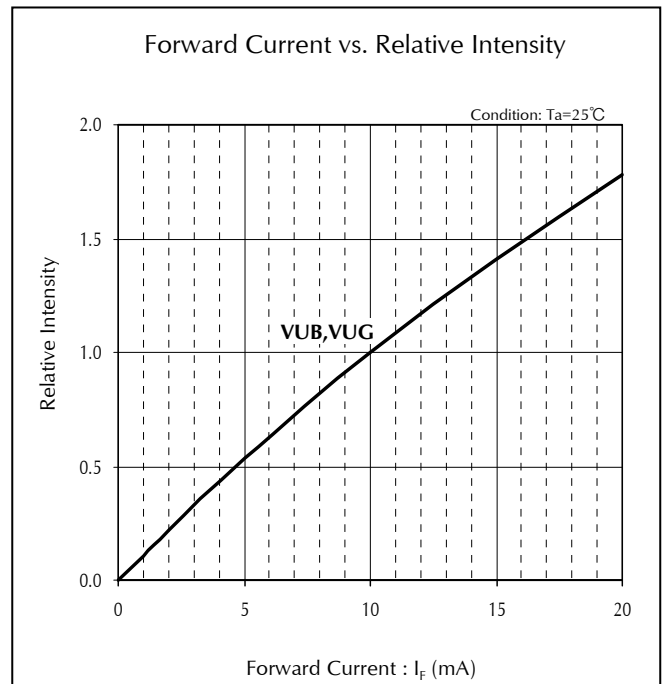
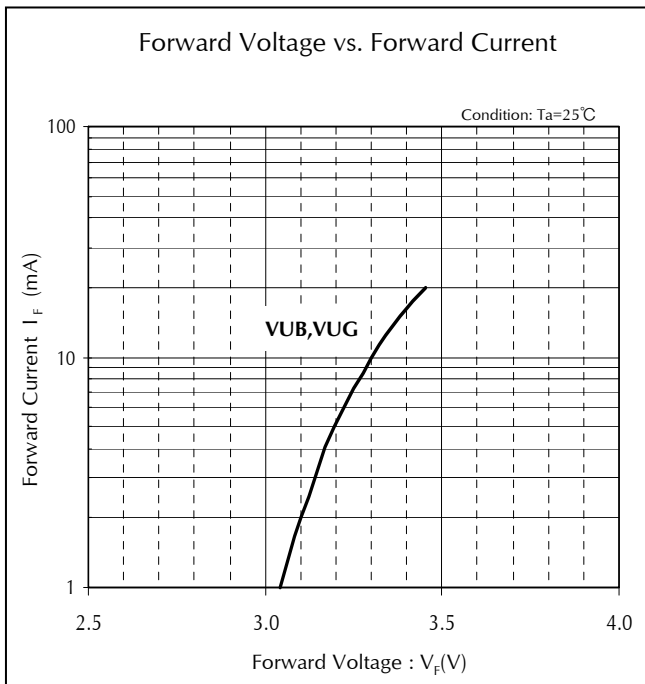
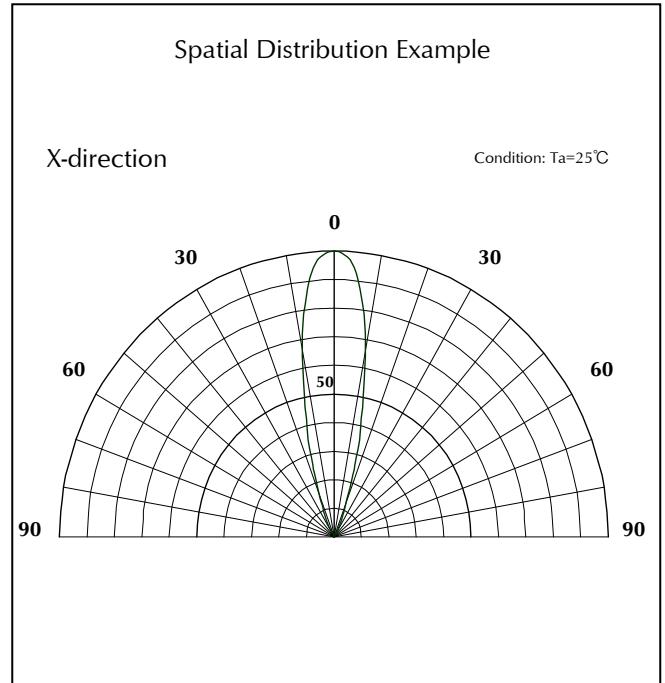
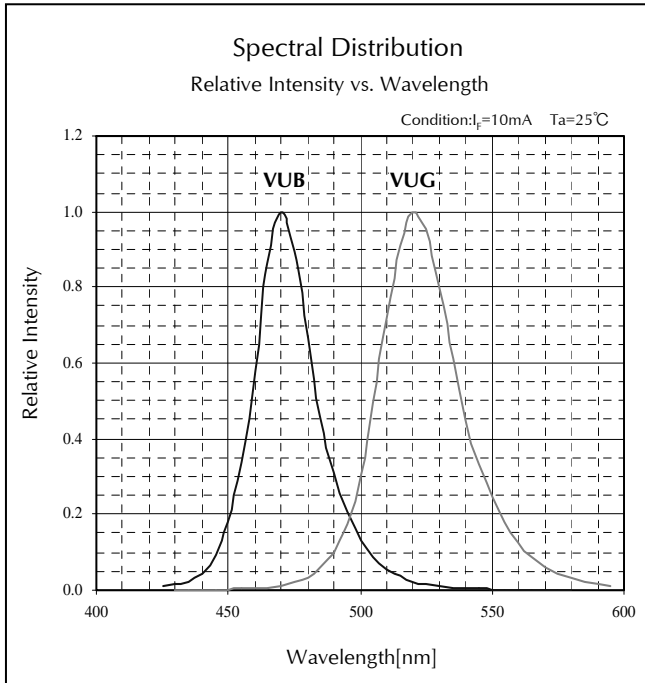

Characteristics Chart (VUB,VUG)

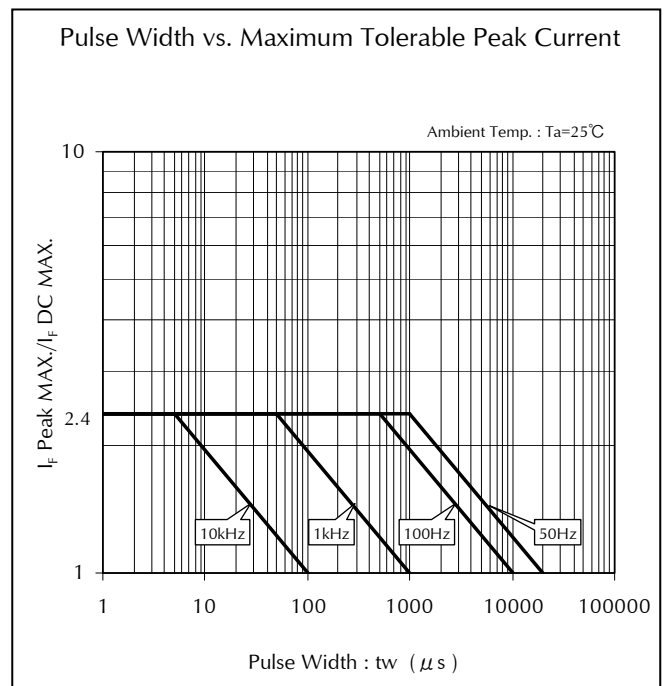
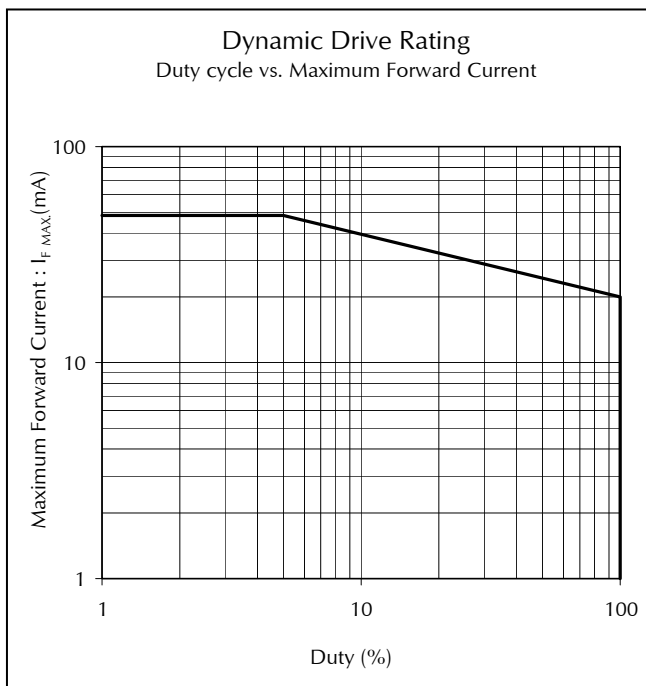
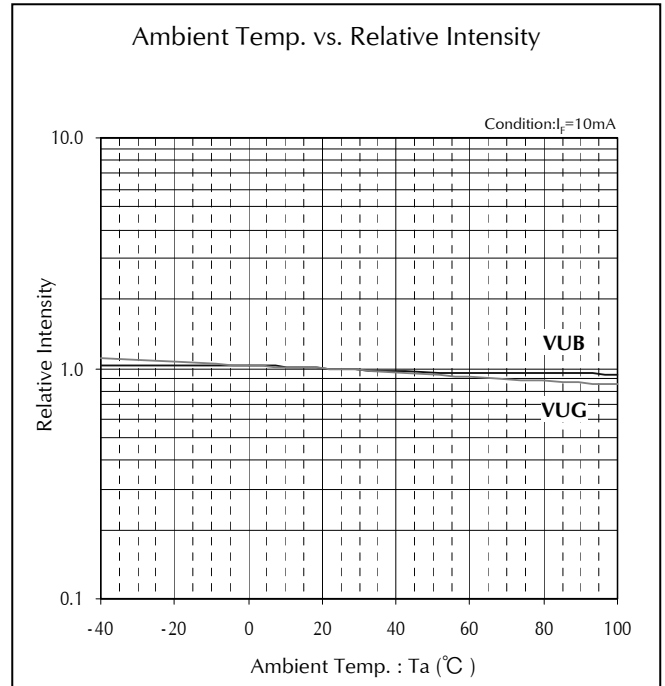
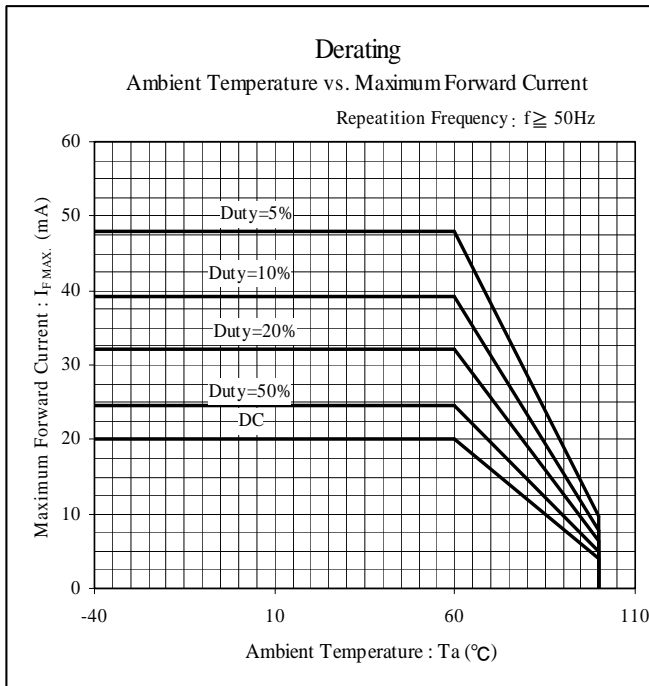

Characteristics Chart (VYBG, VYPY)

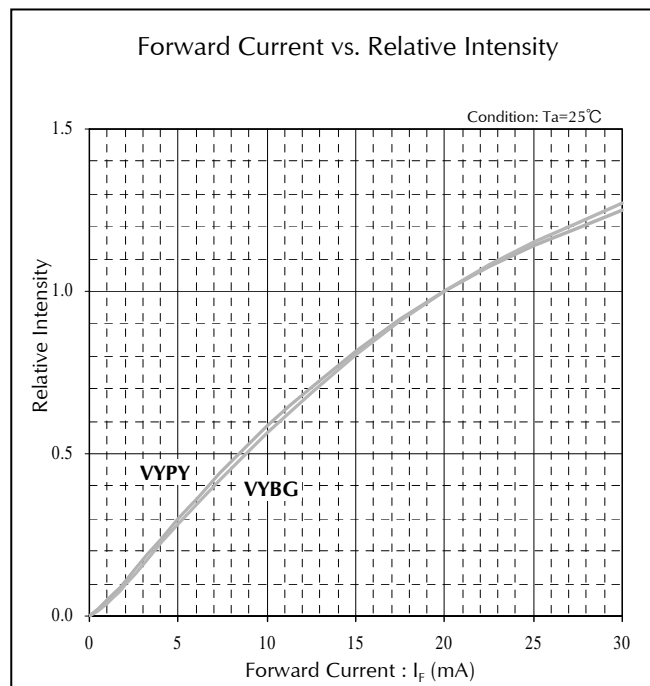
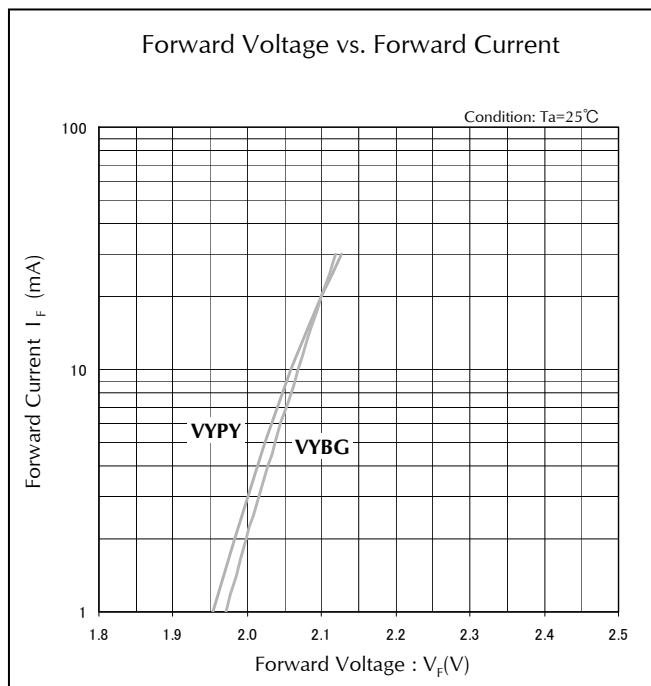
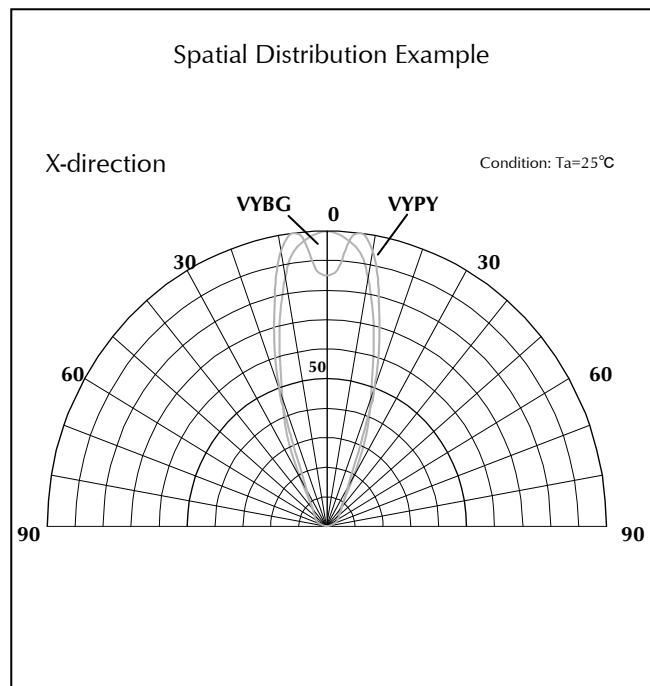
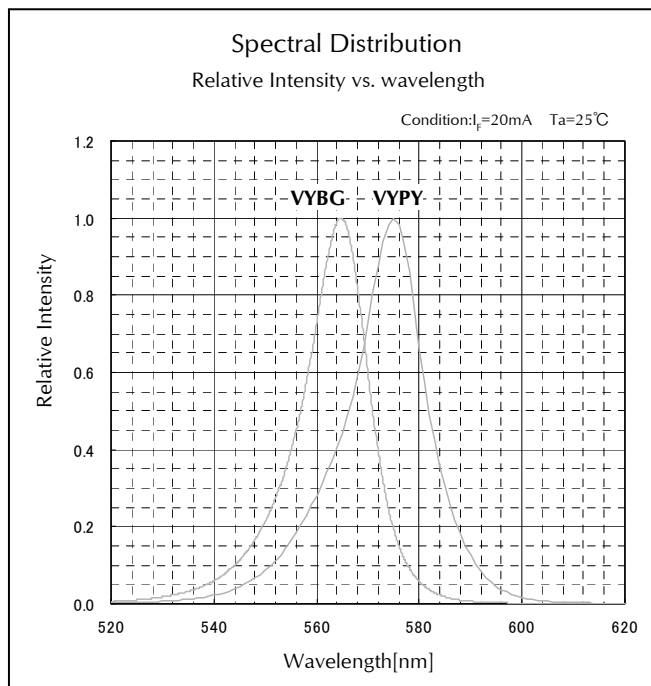

Characteristics Chart (VYBG, VYPY)

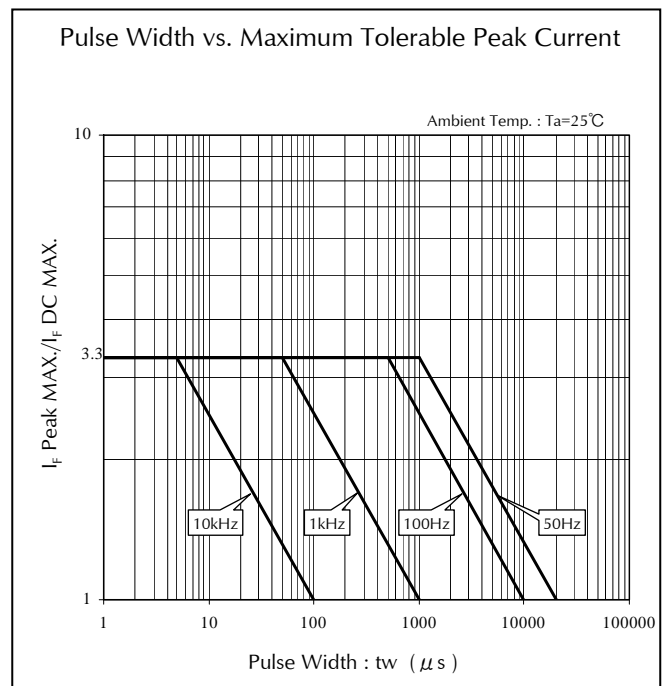
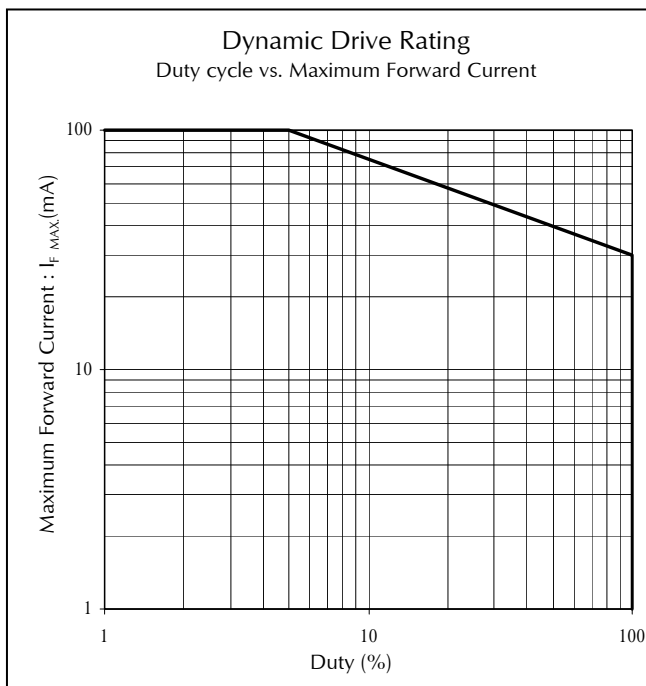
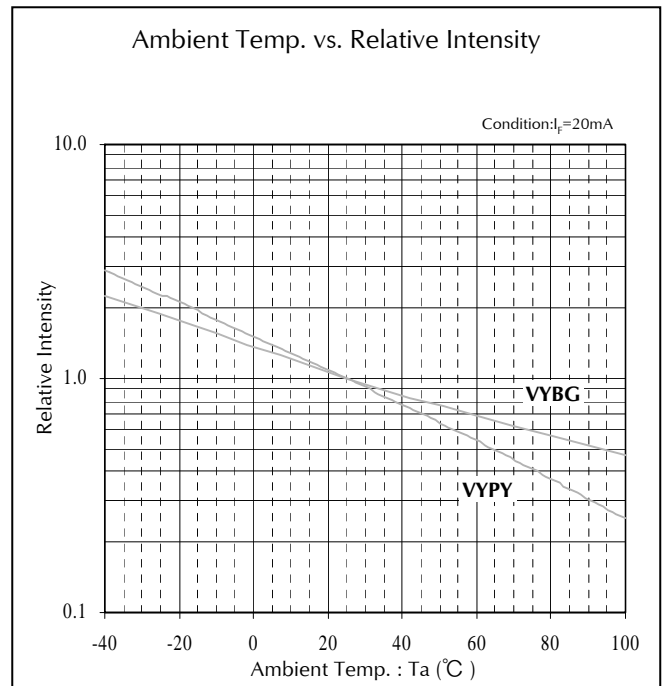
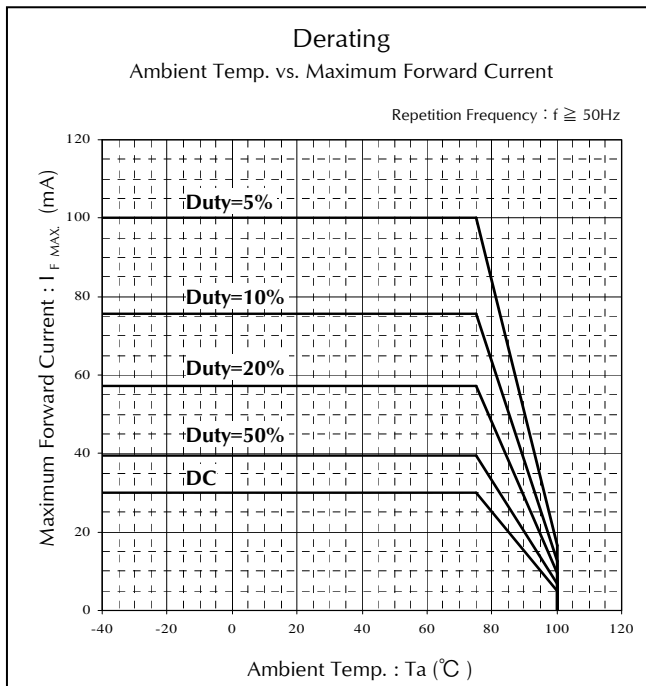

Characteristics Chart (VFY, VFA, VFV, VFR)

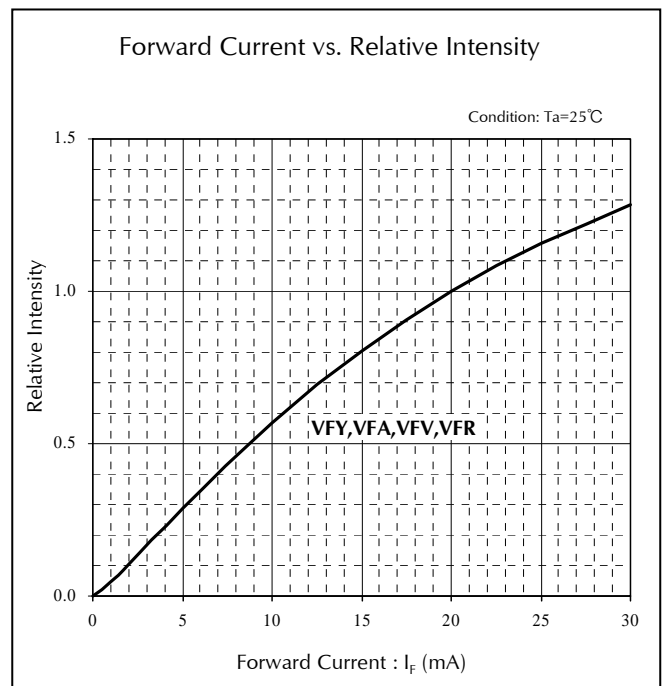
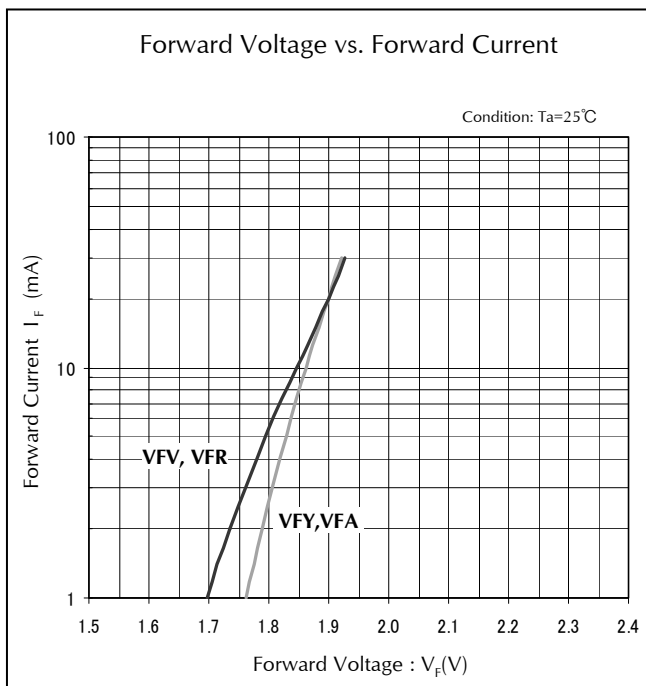
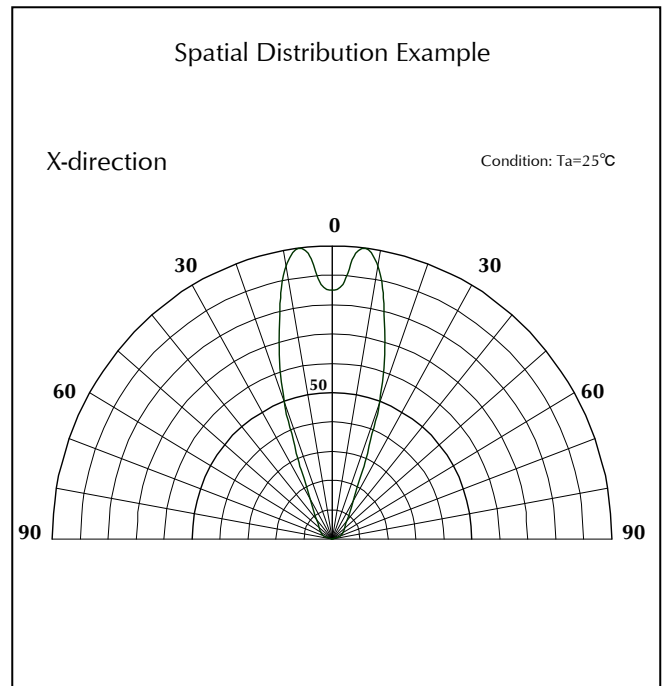
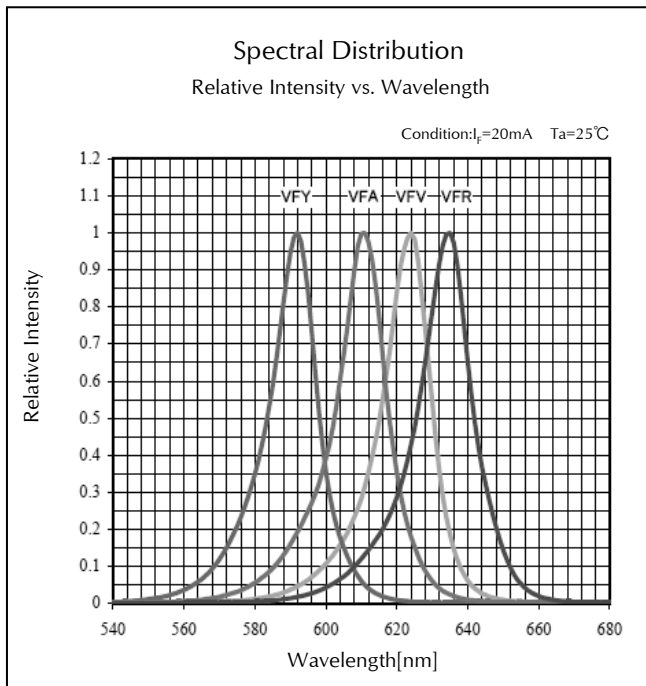

Characteristics Chart (VFY, VFA, VFV, VFR)

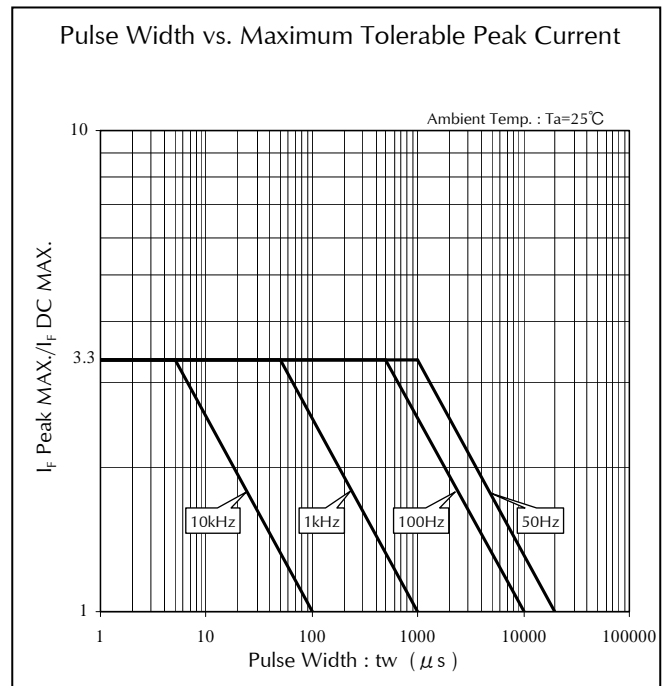
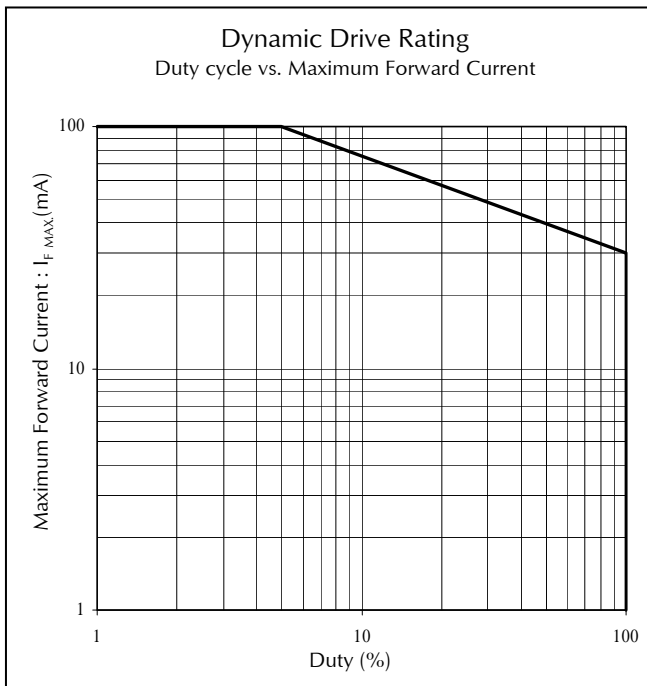
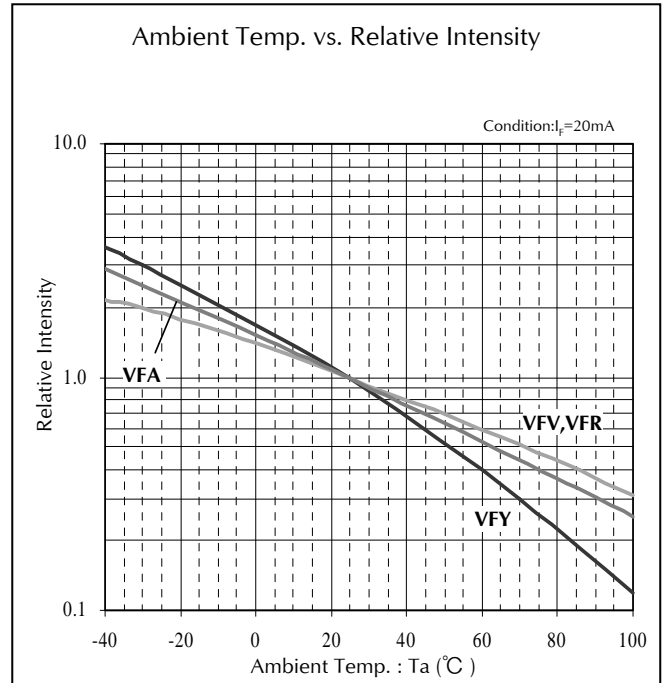
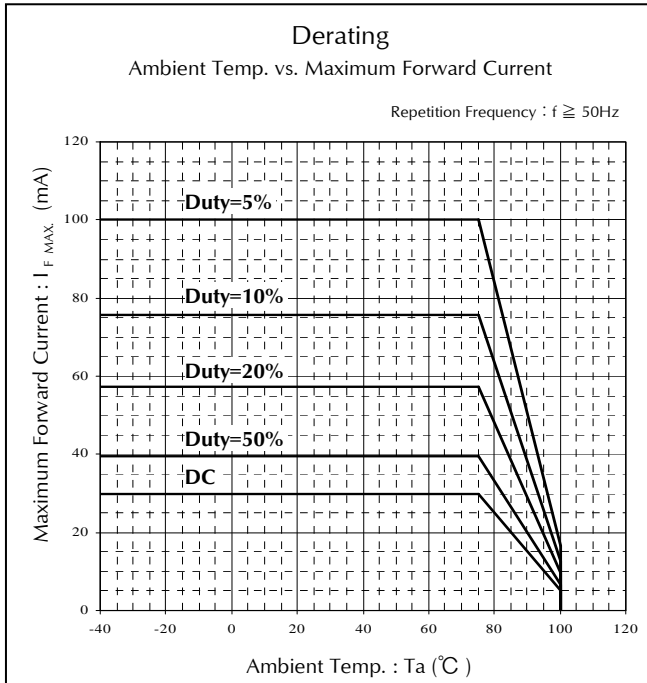

Package Dimensions

(Unit: mm)

Weight: (7.81)mg

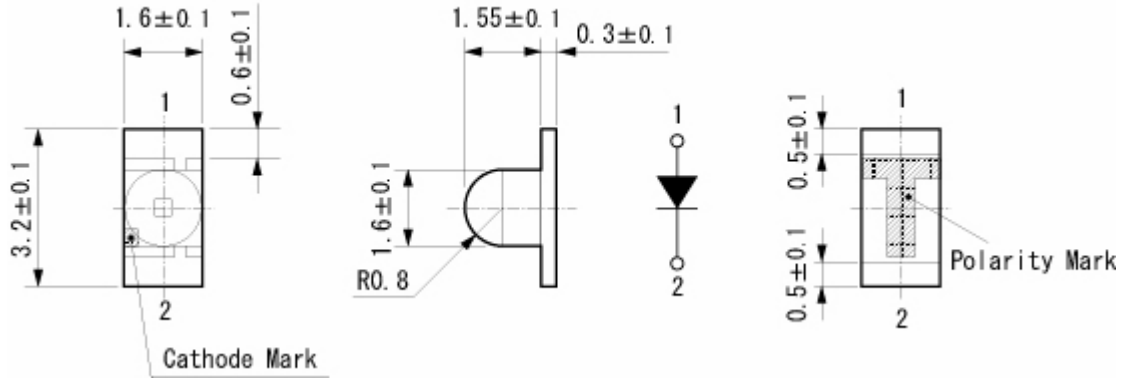

Recommended Soldering Pattern

(Unit: mm)

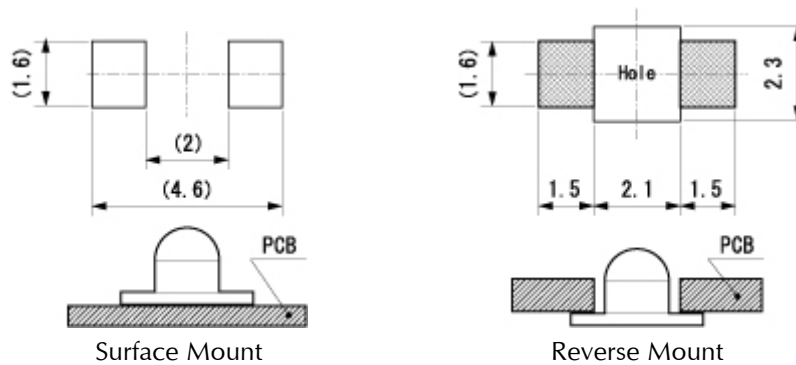

Taping Specification

(Unit: mm)

Part No. : V□□1105W -TR (Surface Mount)
Quantity: 2,000pcs/ reel(standard)

Part No. : V□□1105W -RR (Reverse Mount)
Quantity: 2,000pcs/ reel(standard)

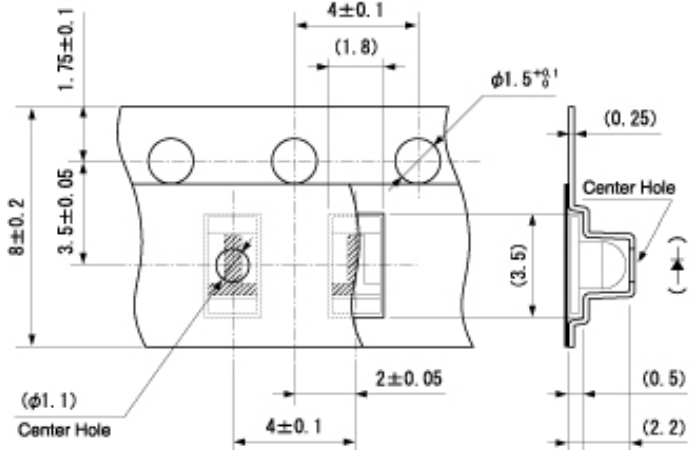
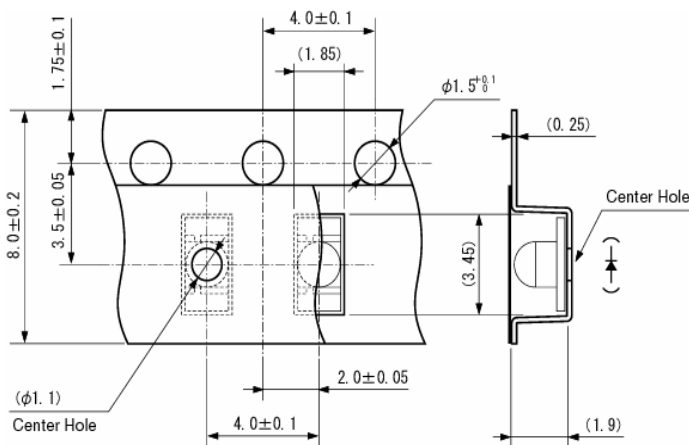

Reflow Soldering Conditions

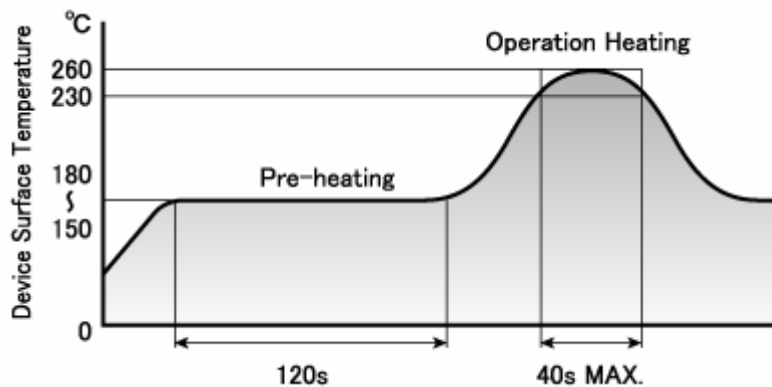

- 1) The above profile temperature gives the maximum temperature of the LED resin surface. Please set the temperature so as to avoid exceeding this range.
- 2) Total times of reflow soldering process shall be no more than 2 times. When the second reflow soldering process is performed, intervals between the first and second reflow should be short as possible (while allowing some time for the component to return to normal temperature after the first reflow) in order to prevent the LED from absorbing moisture.
- 3) Temperature fluctuation to the LED during the pre-heating process shall be minimized.

Manual Soldering Conditions

Iron tip temp.	350 °C	(MAX.)
Soldering time and frequency	3 s	(MAX.)
	1 time	(MAX.)

Reliability Testing Result

Reliability Testing Result	Applicable Standard	Testing Conditions	Duration	Failure
Room Temp. Operating Life	EIAJ ED-4701/100(101)	Ta = 25°C, If = Maximum Rated Current	1,000 h	0/20
High Temp. Operating Life	EIAJ ED-4701/100(101)	Ta = Maximum Rated Operating Temperature, If = Derating Value	1,000 h	0/20
Low Temp. Operating Life	EIAJ ED-4701/100(101)	Ta = -40°C, If = Maximum Rated Current	1,000 h	0/20
Wet High Temp. Operating Life	EIAJ ED-4701/100(102)	Ta = 60°C, 90%, If = Maximum Rated Current	1,000 h	0/20
Wet High Temp. Storage Life	EIAJ ED-4701/100(103)	Ta = 60°C, 90%	1,000 h	0/20
Thermal Shock	EIAJ ED-4701/100(105)	Ta = -40°C ~ Maximum Rated Storage Temperature (each 15min.)	1,000 cycles	0/20
Thermal Shock Operating	EIAJ ED-4701/100(105)	Ta = -40°C(off) ~ 85°C (If = Derating Value on), (each 15min.)	1,000 cycles	0/20
High Temp. Storage Life	EIAJ ED-4701/200(201)	Ta = Maximum Rated Storage Temperature	1,000 h	0/20
Low Temp. Storage Life	EIAJ ED-4701/200(202)	Ta = Minimum Rated Storage Temperature	1,000 h	0/20
Cycled Temp. Humidity Life	EIAJ ED-4701/200(203)	Ta = -30°C(2h) ~ 80°C, 95%(2h), 8h/cycle, If = Derating Value, 5min on-off	30 cycles	0/20
Resistance to Reflow Soldering	EIAJ ED-4701/300(301)	Moisture Soak : 30°C, 70%, 72h Preheat : 150 ~ 180°C(120s Max.) Soldering Temp. : 260°C(5s)	Twice	0/20
Electric Static Discharge (ESD) ^{※1}	EIAJ ED-4701/300(304)	C = 100pF, R2 = 1.5KΩ, ±2,000V	once each polarity	0/10
Vibration, Variable Frequency	EIAJ ED-4701/400(403)	98.1m/s ² (10G), 100 ~ 2KHz, 20min, XYZ each direction	2 h	0/10

※1 Reference test

Failure Criteria

Items	Symbols	Conditions	Failure criteria
Luminous Intensity	Iv	If Value of each product Luminous Intensity	Testing Min. Value < Spec. Min. Value x 0.5
Forward Voltage	V _F	If Value of each product Forward Voltage	Testing Max. Value ≥ Spec. Max. Value x 1.2
Reverse Current	I _R	V _R = Maximum Rated Reverse Voltage V	Testing Max. Value ≥ Spec. Max. Value x 2.5
Cosmetic Appearance	-	-	Occurrence of notable decoloration, deformation and cracking

Special Notice to Customers Using the Products and Technical Information Shown in This Data Sheet

- 1) The technical information shown in the data sheets are limited to the typical characteristics and circuit examples of the referenced products. It does not constitute the warranting of industrial property nor the granting of any license.
- 2) For the purpose of product improvement, the specifications, characteristics and technical data described in the data sheets are subject to change without prior notice. Therefore it is recommended that the most updated specifications be used in your design.
- 3) When using the products described in the data sheets, please adhere to the maximum ratings for operating voltage, heat dissipation characteristics, and other precautions for use. We are not responsible for any damage which may occur if these specifications are exceeded.
- 4) The products that have been described to this catalog are manufactured so that they will be used for the electrical instrument of the benchmark (OA equipment, telecommunications equipment, AV machine, home appliance and measuring instrument).
The application of aircrafts, space borne application, transportation equipment, medical equipment and nuclear power control equipment, etc. needs a high reliability and safety, and the breakdown and the wrong operation might influence the life or the human body. Please consult us beforehand if you plan to use our product for the usages of aircrafts, space borne application, transportation equipment, medical equipment and nuclear power control equipment, etc. except OA equipment, telecommunications equipment, AV machine, home appliance and measuring instrument.
- 5) In order to export the products or technologies described in this data sheet which are under the "Foreign Exchange and Foreign Trade Control Law," it is necessary to first obtain an export permit from the Japanese government.
- 6) No part of this data sheet may be reprinted or reproduced without prior written permission from Stanley Electric Co., Ltd.
- 7) The most updated edition of this data sheet can be obtained from the address below:
<http://www.stanley-components.com>

Looking for pricing, stock, or lifecycle information?

Click below to explore more details on WIN SOURCE:

-  [View VFR1105W-TR on WIN SOURCE](#)
-  [Stanley Electric Co Information](#)

Optimize Your Supply Chain with WIN SOURCE Solutions

-  Global Sourcing Solution
-  Obsolete Management
-  Cost Control Management
-  Shortage Management
-  Alternative Solution
-  Excess Inventory Management