



**THE DATASHEET OF
MBRD330RLG**



MBRD320G, MBRD330G, MBRD340G, MBRD350G, MBRD360G

Switch-mode Power Rectifiers

DPAK Surface Mount Package

These state-of-the-art devices are designed for use as output rectifiers, free wheeling, protection and steering diodes in switching power supplies, inverters and other inductive switching circuits.

Features

- Extremely Fast Switching
- Extremely Low Forward Drop
- Platinum Barrier with Avalanche Guardrings
- NRVBD and SBRD Prefixes for Automotive and Other Applications Requiring Unique Site and Control Change Requirements; AEC-Q101 Qualified and PPAP Capable
- These Devices are Pb-Free, Halogen Free/BFR Free and are RoHS Compliant

Mechanical Characteristics:

- Case: Epoxy, Molded
- Weight: 0.4 Gram (Approximately)
- Finish: All External Surfaces Corrosion Resistant and Terminal Leads are Readily Solderable
- Lead and Mounting Surface Temperature for Soldering Purposes; 260°C Max. for 10 Seconds
- ESD Ratings:
 - ◆ Machine Model = C
 - ◆ Human Body Model = 3B



ON Semiconductor®

www.onsemi.com

SCHOTTKY BARRIER RECTIFIERS 3.0 AMPERES, 20 – 60 VOLTS

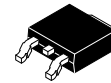

DPAK
CASE 369C

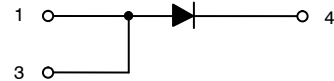

MARKING DIAGRAM

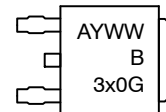

A	= Assembly Location*
Y	= Year
WW	= Work Week
B3x0	= Device Code
x	= 2, 3, 4, 5, or 6
G	= Pb-Free Package

* The Assembly Location Code (A) is front side optional. In cases where the Assembly Location is stamped in the package bottom (molding ejecter pin), the front side assembly code may be blank.

ORDERING INFORMATION

See detailed ordering and shipping information in the package dimensions section on page 3 of this data sheet.

MBRD320G, MBRD330G, MBRD340G, MBRD350G, MBRD360G

MAXIMUM RATINGS

Rating	Symbol	MBRD/SBRD8					Unit
		320	330	340	350	360	
Peak Repetitive Reverse Voltage Working Peak Reverse Voltage DC Blocking Voltage	V_{RRM} V_{RWM} V_R	20	30	40	50	60	V
Average Rectified Forward Current ($T_C = +125^\circ\text{C}$, Rated V_R)	$I_{F(AV)}$	3					A
Peak Repetitive Forward Current, $T_C = +125^\circ\text{C}$ (Rated V_R , Square Wave, 20 kHz)	I_{FRM}	6					A
Nonrepetitive Peak Surge Current (Surge applied at rated load conditions halfwave, single phase, 60 Hz)	I_{FSM}	75					A
Peak Repetitive Reverse Surge Current (2 μs , 1 kHz)	I_{RRM}	1					A
Operating Junction Temperature Range (Note 1)	T_J	-65 to +175					$^\circ\text{C}$
Storage Temperature Range	T_{stg}	-65 to +175					$^\circ\text{C}$
Voltage Rate of Change (Rated V_R)	dv/dt	10,000					$\text{V}/\mu\text{s}$

Stresses exceeding those listed in the Maximum Ratings table may damage the device. If any of these limits are exceeded, device functionality should not be assumed, damage may occur and reliability may be affected.

1. The heat generated must be less than the thermal conductivity from Junction-to-Ambient: $dP_D/dT_J < 1/R_{\theta JA}$.

THERMAL CHARACTERISTICS

Characteristic	Symbol	Value	Unit
Maximum Thermal Resistance, Junction-to-Case	$R_{\theta JC}$	6	$^\circ\text{C}/\text{W}$
Maximum Thermal Resistance, Junction-to-Ambient (Note 2)	$R_{\theta JA}$	80	$^\circ\text{C}/\text{W}$

2. Rating applies when surface mounted on the minimum pad size recommended.

ELECTRICAL CHARACTERISTICS

Characteristic	Symbol	Value	Unit
Maximum Instantaneous Forward Voltage (Note 3) $i_F = 3 \text{ Amps}, T_C = +25^\circ\text{C}$ $i_F = 3 \text{ Amps}, T_C = +125^\circ\text{C}$ $i_F = 6 \text{ Amps}, T_C = +25^\circ\text{C}$ $i_F = 6 \text{ Amps}, T_C = +125^\circ\text{C}$	V_F	0.6 0.45 0.7 0.625	V
Maximum Instantaneous Reverse Current (Note 3) (Rated dc Voltage, $T_C = +25^\circ\text{C}$) (Rated dc Voltage, $T_C = +125^\circ\text{C}$)	i_R	0.2 20	mA

Product parametric performance is indicated in the Electrical Characteristics for the listed test conditions, unless otherwise noted. Product performance may not be indicated by the Electrical Characteristics if operated under different conditions.

3. Pulse Test: Pulse Width = 300 μs , Duty Cycle $\leq 2.0\%$.

MBRD320G, MBRD330G, MBRD340G, MBRD350G, MBRD360G

ORDERING INFORMATION

Device	Package	Shipping†
MBRD320G	DPAK (Pb-Free)	75 Units / Rail
SBRD8320G*		75 Units / Rail
SBRD8320G-VF01*		75 Units / Rail
MBRD320RLG		1,800 Tape & Reel
MBRD320T4G		2,500 Tape & Reel
SBRD8320T4G*		2,500 Tape & Reel
SBRD8320T4G-VF01*		2,500 Tape & Reel
MBRD330G		75 Units / Rail
SBRD8330G*		75 Units / Rail
SBRD8330G-VF01*		75 Units / Rail
MBRD330RLG		1,800 Tape & Reel
MBRD330T4G		2,500 Tape & Reel
SBRD8330T4G*		2,500 Tape & Reel
SBRD8330T4G-VF01*		2,500 Tape & Reel
MBRD340G		75 Units / Rail
SBRD8340G*		75 Units / Rail
SBRD8340G-VF01*		75 Units / Rail
MBRD340RLG		1,800 Tape & Reel
MBRD340T4G		2,500 Tape & Reel
SBRD8340T4G*		2,500 Tape & Reel
SBRD8340T4G-VF01*		2,500 Tape & Reel
MBRD350G		75 Units / Rail
SBRD8350G*		75 Units / Rail
SBRD8350G-VF01*		75 Units / Rail
MBRD350RLG		1,800 Tape & Reel
SBRD8350RLG*		1,800 Tape & Reel
SBRD8350RLG-VF01*		1,800 Tape & Reel
MBRD350T4G		2,500 Tape & Reel
SBRD8350T4G*		2,500 Tape & Reel
SBRD8350T4G-VF01*		2,500 Tape & Reel
MBRD360G		75 Units / Rail
SBRD8360G*		75 Units / Rail
SBRD8360G-VF01*		75 Units / Rail
MBRD360RLG		1,800 Tape & Reel
SBRD8360RLG*		1,800 Tape & Reel
SBRD8360RLG-VF01*		1,800 Tape & Reel
MBRD360T4G		2,500 Tape & Reel
NRVBD360VT4G*		2,500 Tape & Reel
SBRD8360T4G*		2,500 Tape & Reel

†For information on tape and reel specifications, including part orientation and tape sizes, please refer to our Tape and Reel Packaging Specifications Brochure, BRD8011/D.

*NRVBD and SBRD Prefixes for Automotive and Other Applications Requiring Unique Site and Control Change Requirements; AEC-Q101 Qualified and PPAP Capable.

TYPICAL CHARACTERISTICS

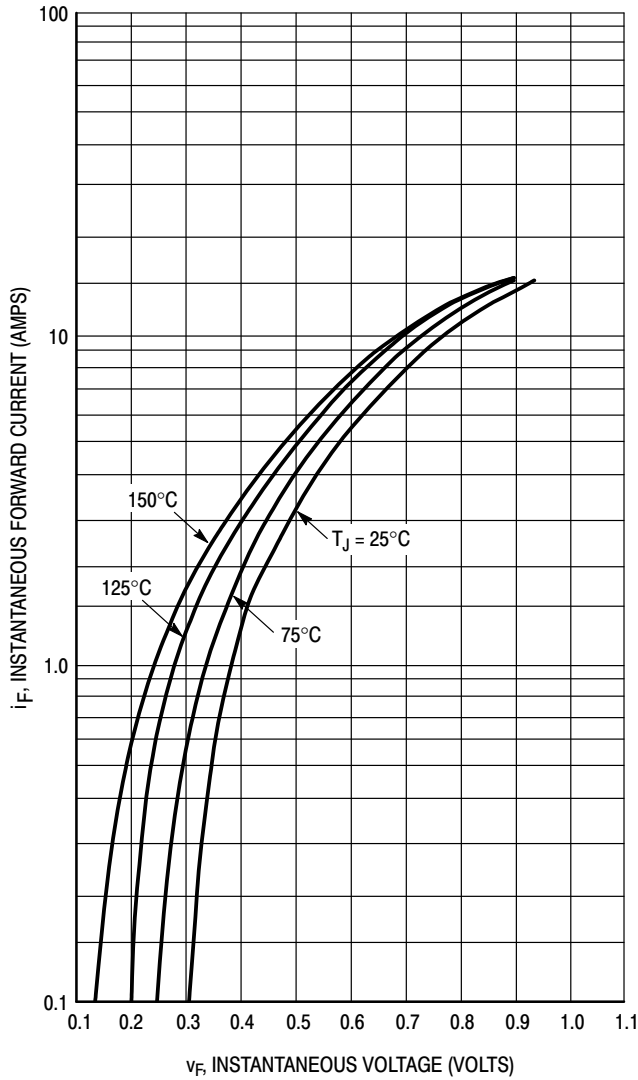
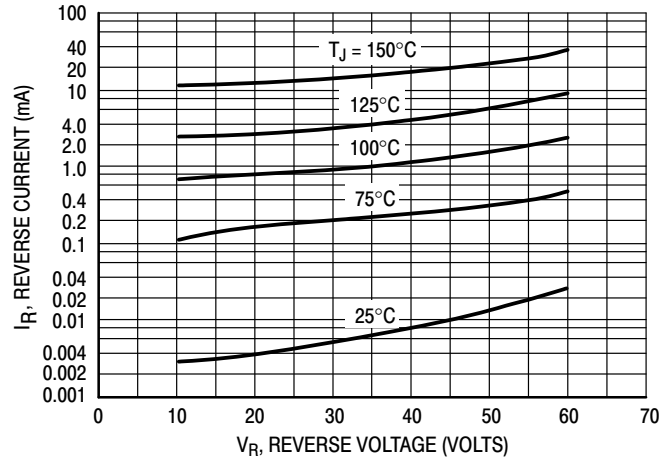

Figure 1. Typical Forward Voltage



*The curves shown are typical for the highest voltage device in the voltage grouping. Typical reverse current for lower voltage selections can be estimated from these curves if V_R is sufficient below rated V_R .

Figure 2. Typical Reverse Current

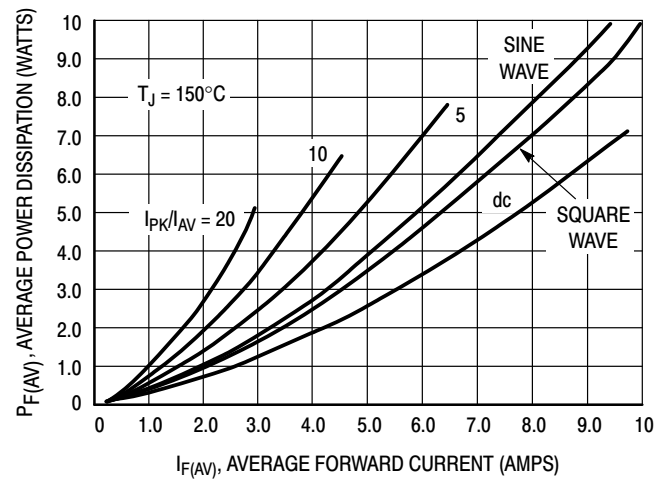

Figure 3. Average Power Dissipation

TYPICAL CHARACTERISTICS

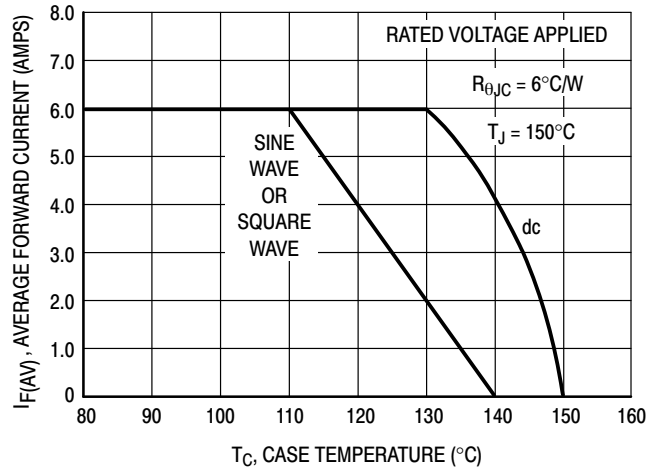

Figure 4. Current Derating, Case

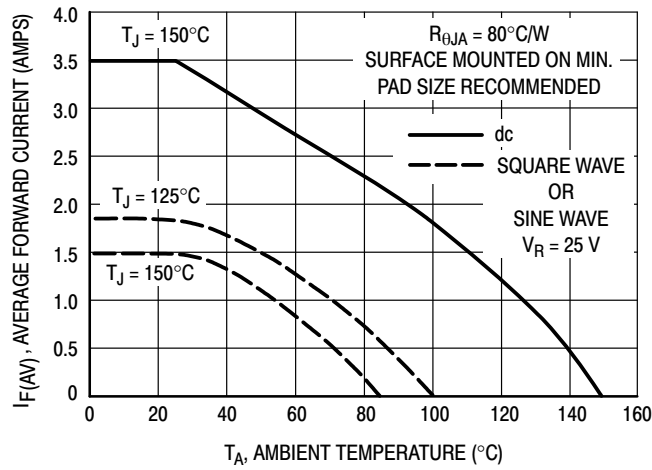

Figure 5. Current Derating, Ambient

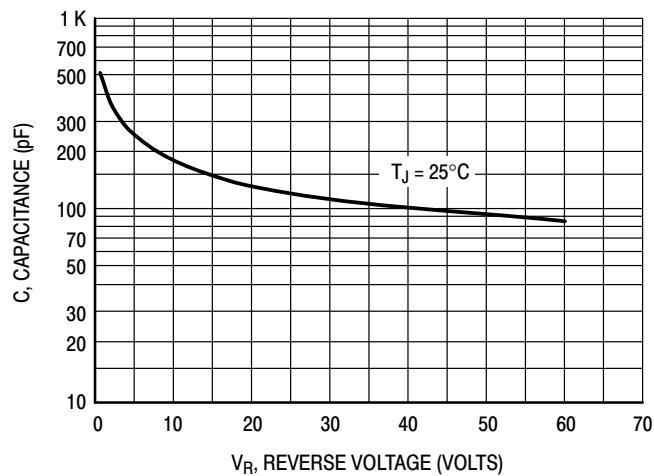
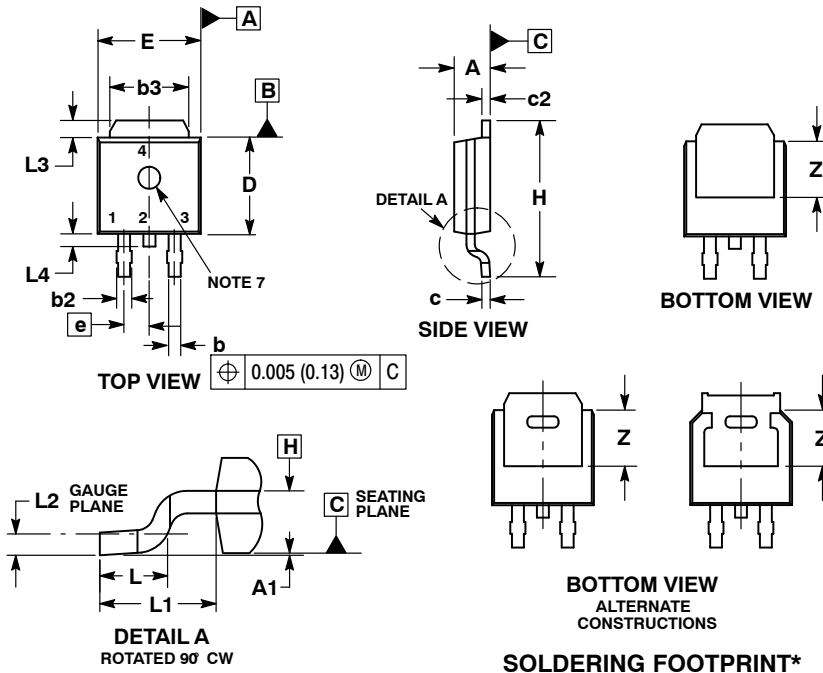

Figure 6. Typical Capacitance

MBRD320G, MBRD330G, MBRD340G, MBRD350G, MBRD360G

PACKAGE DIMENSIONS

DPAK (SINGLE GAUGE) CASE 369C ISSUE F



NOTES:

1. DIMENSIONING AND TOLERANCING PER ASME Y14.5M, 1994.
2. CONTROLLING DIMENSION: INCHES.
3. THERMAL PAD CONTOUR OPTIONAL WITHIN DIMENSIONS b3, L3 and Z.
4. DIMENSIONS D AND E DO NOT INCLUDE MOLD FLASH, PROTRUSIONS, OR BURRS. MOLD FLASH, PROTRUSIONS, OR GATE BURRS SHALL NOT EXCEED 0.006 INCHES PER SIDE.
5. DIMENSIONS D AND E ARE DETERMINED AT THE OUTERMOST EXTREMES OF THE PLASTIC BODY.
6. DATUMS A AND B ARE DETERMINED AT DATUM PLANE H.
7. OPTIONAL MOLD FEATURE.

DIM	INCHES		MILLIMETERS	
	MIN	MAX	MIN	MAX
A	0.086	0.094	2.18	2.38
A1	0.000	0.005	0.00	0.13
b	0.025	0.035	0.63	0.89
b2	0.028	0.045	0.72	1.14
b3	0.180	0.215	4.57	5.46
c	0.018	0.024	0.46	0.61
c2	0.018	0.024	0.46	0.61
D	0.235	0.245	5.97	6.22
E	0.250	0.265	6.35	6.73
e	0.090	BSC	2.29	BSC
H	0.370	0.410	9.40	10.41
L	0.055	0.070	1.40	1.78
L1	0.114	REF	2.90	REF
L2	0.020	BSC	0.51	BSC
L3	0.035	0.050	0.89	1.27
L4	---	0.040	---	1.01
Z	0.155	---	3.93	---

SOLDERING FOOTPRINT*

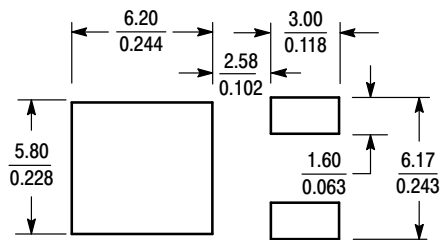

SCALE 3:1 $\left(\frac{\text{mm}}{\text{inches}}\right)$

*For additional information on our Pb-Free strategy and soldering details, please download the ON Semiconductor Soldering and Mounting Techniques Reference Manual, SOLDERRM/D.

ON Semiconductor and are trademarks of Semiconductor Components Industries, LLC dba ON Semiconductor or its subsidiaries in the United States and/or other countries. ON Semiconductor owns the rights to a number of patents, trademarks, copyrights, trade secrets, and other intellectual property. A listing of ON Semiconductor's product/patent coverage may be accessed at www.onsemi.com/site/pdf/Patent-Marking.pdf. ON Semiconductor reserves the right to make changes without further notice to any products herein. ON Semiconductor makes no warranty, representation or guarantee regarding the suitability of its products for any particular purpose, nor does ON Semiconductor assume any liability arising out of the application or use of any product or circuit, and specifically disclaims any and all liability, including without limitation special, consequential or incidental damages. Buyer is responsible for its products and applications using ON Semiconductor products, including compliance with all laws, regulations and safety requirements or standards, regardless of any support or applications information provided by ON Semiconductor. "Typical" parameters which may be provided in ON Semiconductor data sheets and/or specifications can and do vary in different applications and actual performance may vary over time. All operating parameters, including "Typicals" must be validated for each customer application by customer's technical experts. ON Semiconductor does not convey any license under its patent rights nor the rights of others. ON Semiconductor products are not designed, intended, or authorized for use as a critical component in life support systems or any FDA Class 3 medical devices or medical devices with a same or similar classification in a foreign jurisdiction or any devices intended for implantation in the human body. Should Buyer purchase or use ON Semiconductor products for any such unintended or unauthorized application, Buyer shall indemnify and hold ON Semiconductor and its officers, employees, subsidiaries, affiliates, and distributors harmless against all claims, costs, damages, and expenses, and reasonable attorney fees arising out of, directly or indirectly, any claim of personal injury or death associated with such unintended or unauthorized use, even if such claim alleges that ON Semiconductor was negligent regarding the design or manufacture of the part. ON Semiconductor is an Equal Opportunity/Affirmative Action Employer. This literature is subject to all applicable copyright laws and is not for resale in any manner.

PUBLICATION ORDERING INFORMATION

LITERATURE FULFILLMENT:

Literature Distribution Center for ON Semiconductor
19521 E. 32nd Pkwy, Aurora, Colorado 80011 USA
Phone: 303-675-2175 or 800-344-3860 Toll Free USA/Canada
Fax: 303-675-2176 or 800-344-3867 Toll Free USA/Canada
Email: orderlit@onsemi.com

N. American Technical Support: 800-282-9855 Toll Free
USA/Canada
Europe, Middle East and Africa Technical Support:
Phone: 421 33 790 2910
Japan Customer Focus Center
Phone: 81-3-5817-1050

ON Semiconductor Website: www.onsemi.com

Order Literature: <http://www.onsemi.com/orderlit>

For additional information, please contact your local Sales Representative

Looking for pricing, stock, or lifecycle information?

Click below to explore more details on WIN SOURCE:

- ⊖ [View MBRD330RLG on WIN SOURCE](#)
- ⊖ [ON Semiconductor Information](#)

Optimize Your Supply Chain with WIN SOURCE Solutions

- ✓ Global Sourcing Solution
- ✓ Obsolete Management
- ✓ Cost Control Management
- ✓ Shortage Management
- ✓ Alternative Solution
- ✓ Excess Inventory Management