



**THE DATASHEET OF**  
**1-1437540-7**



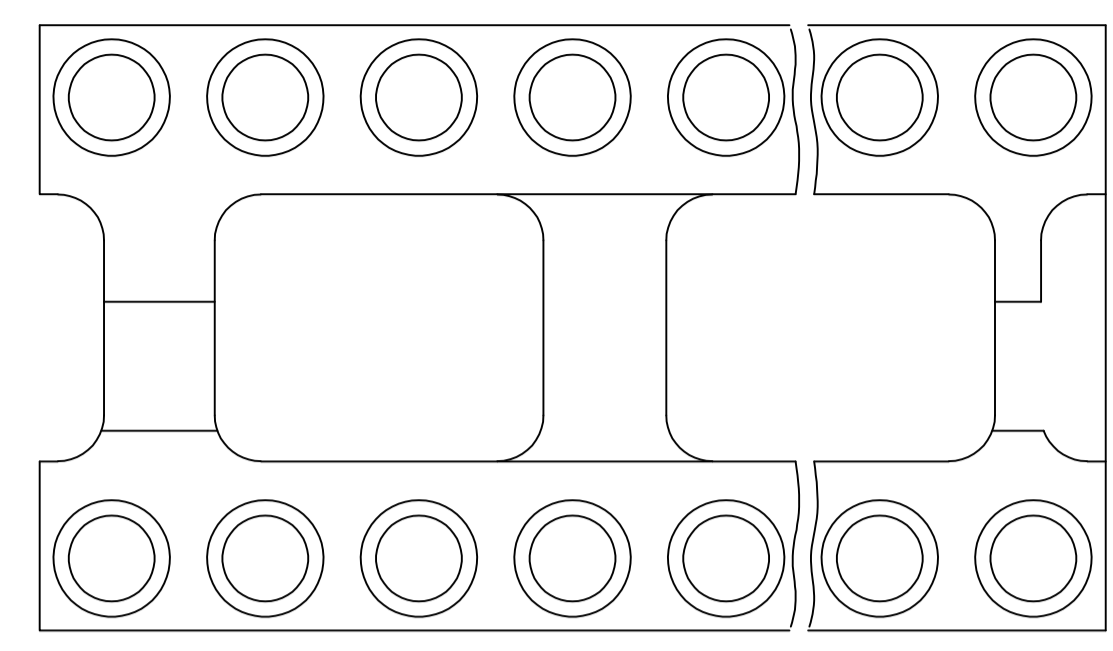

FIG. 1

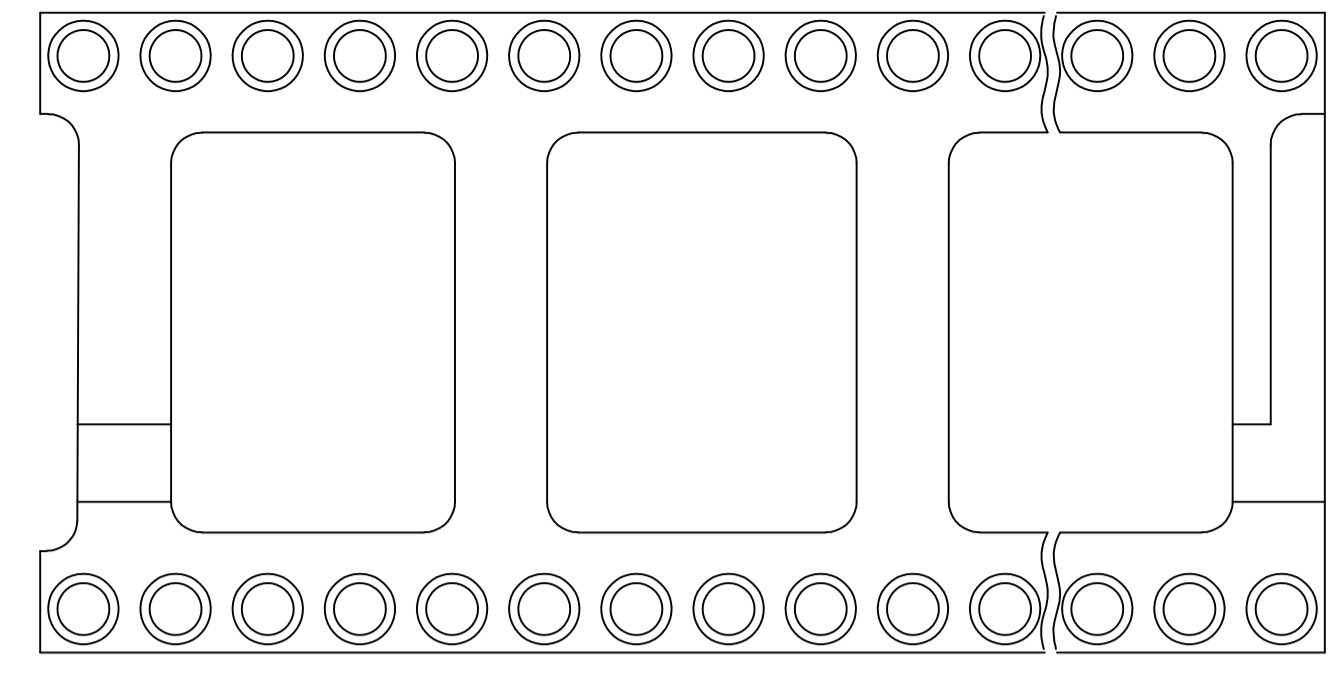

FIG. 2

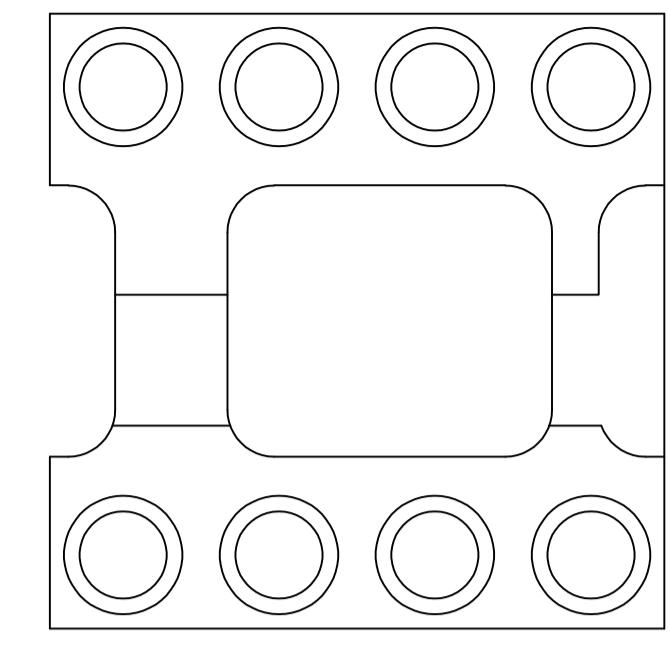
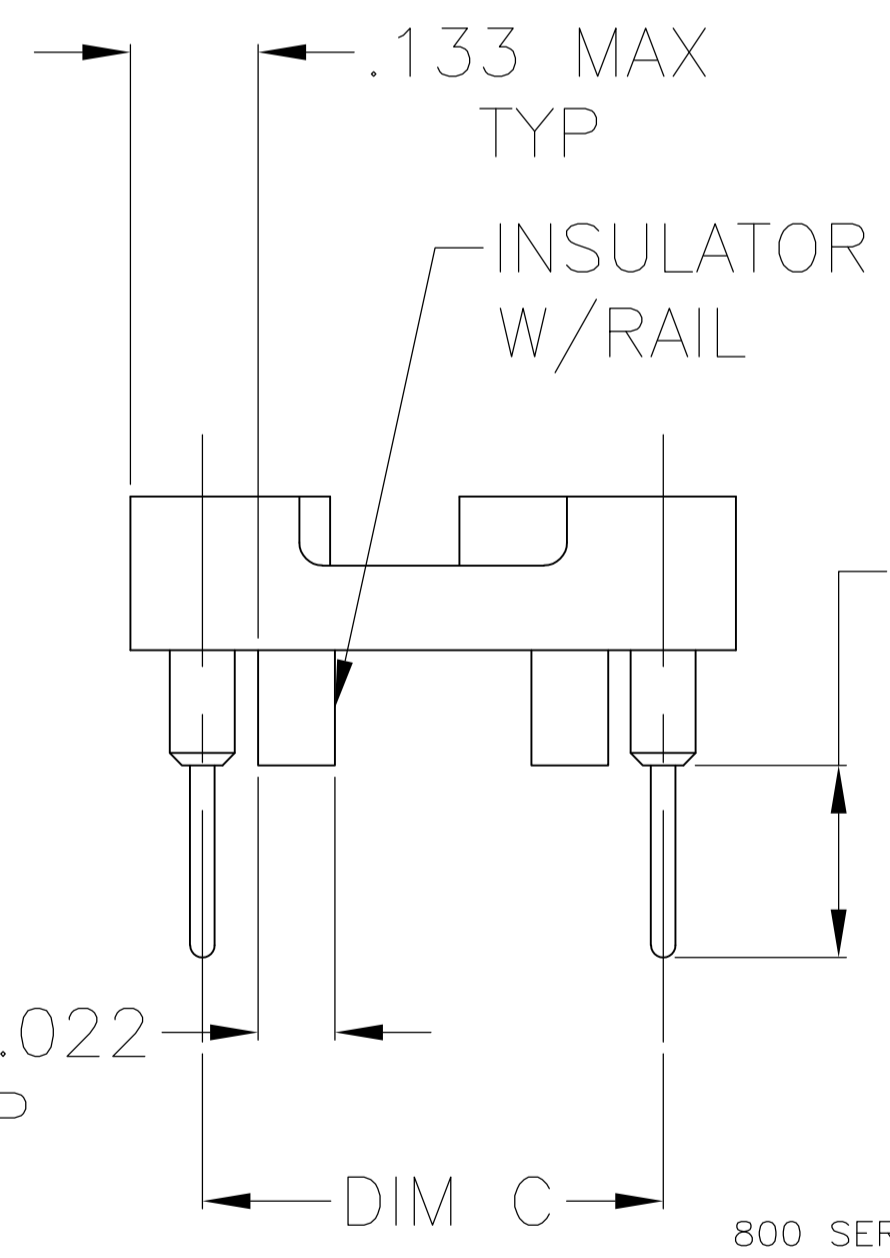
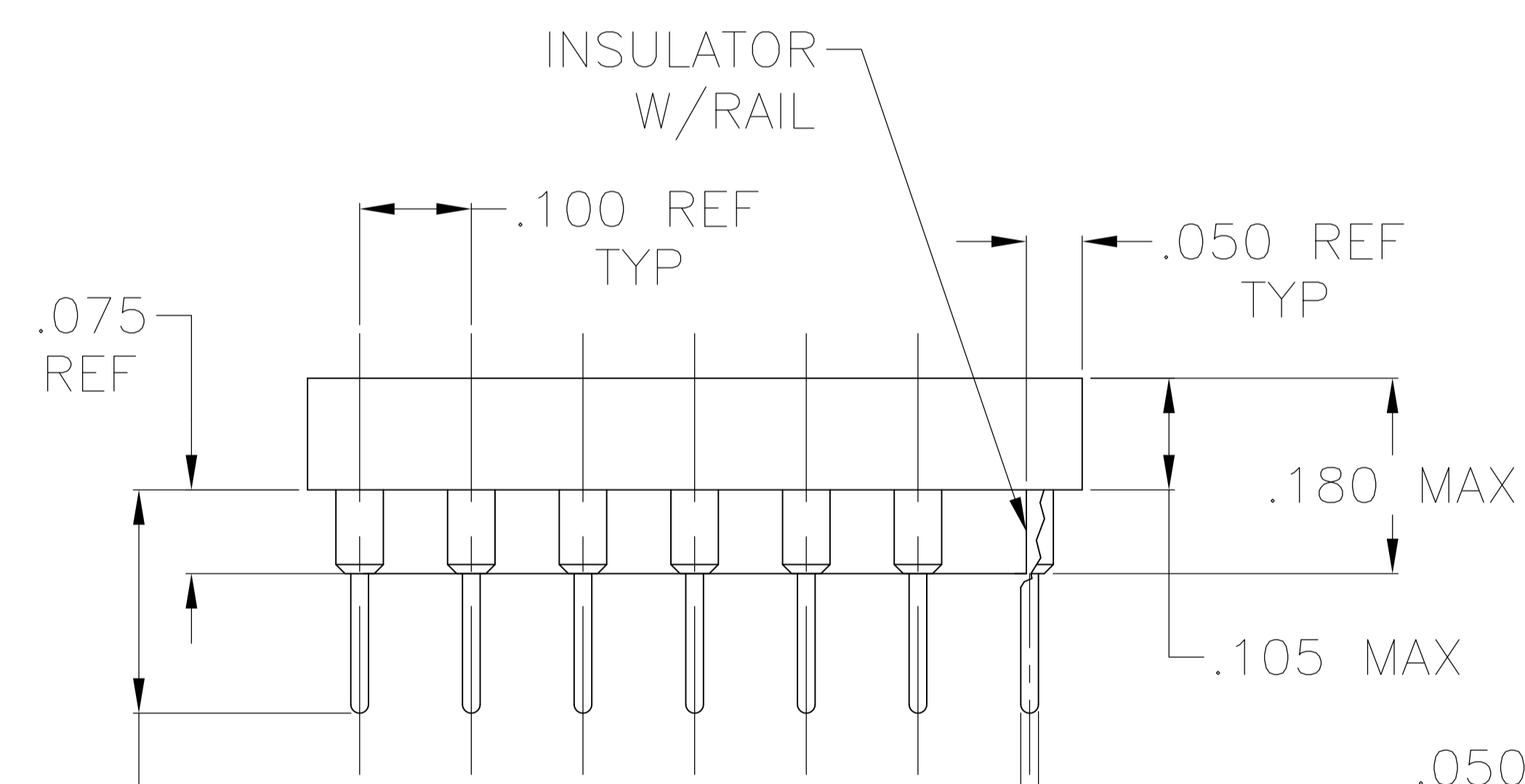
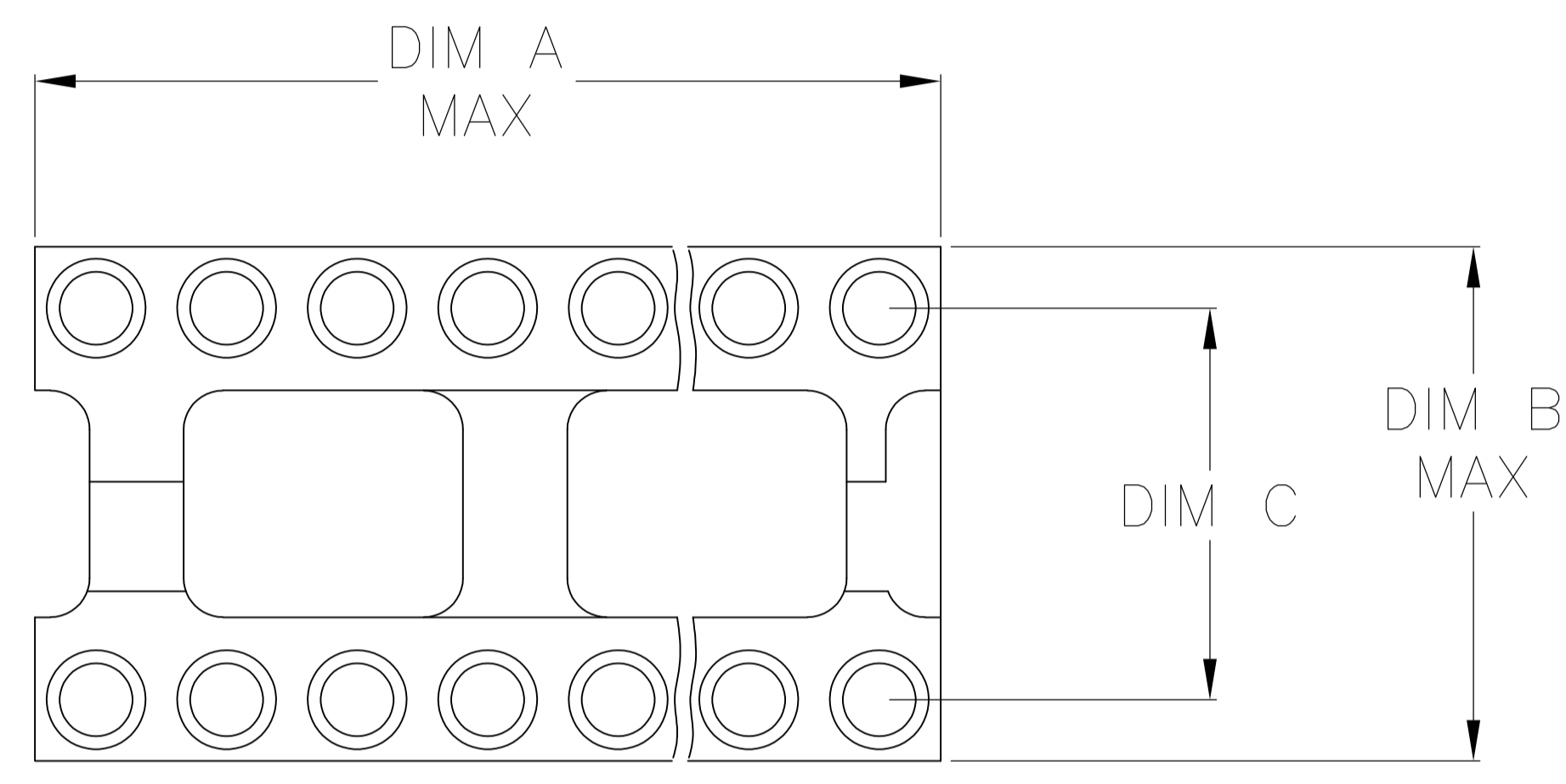
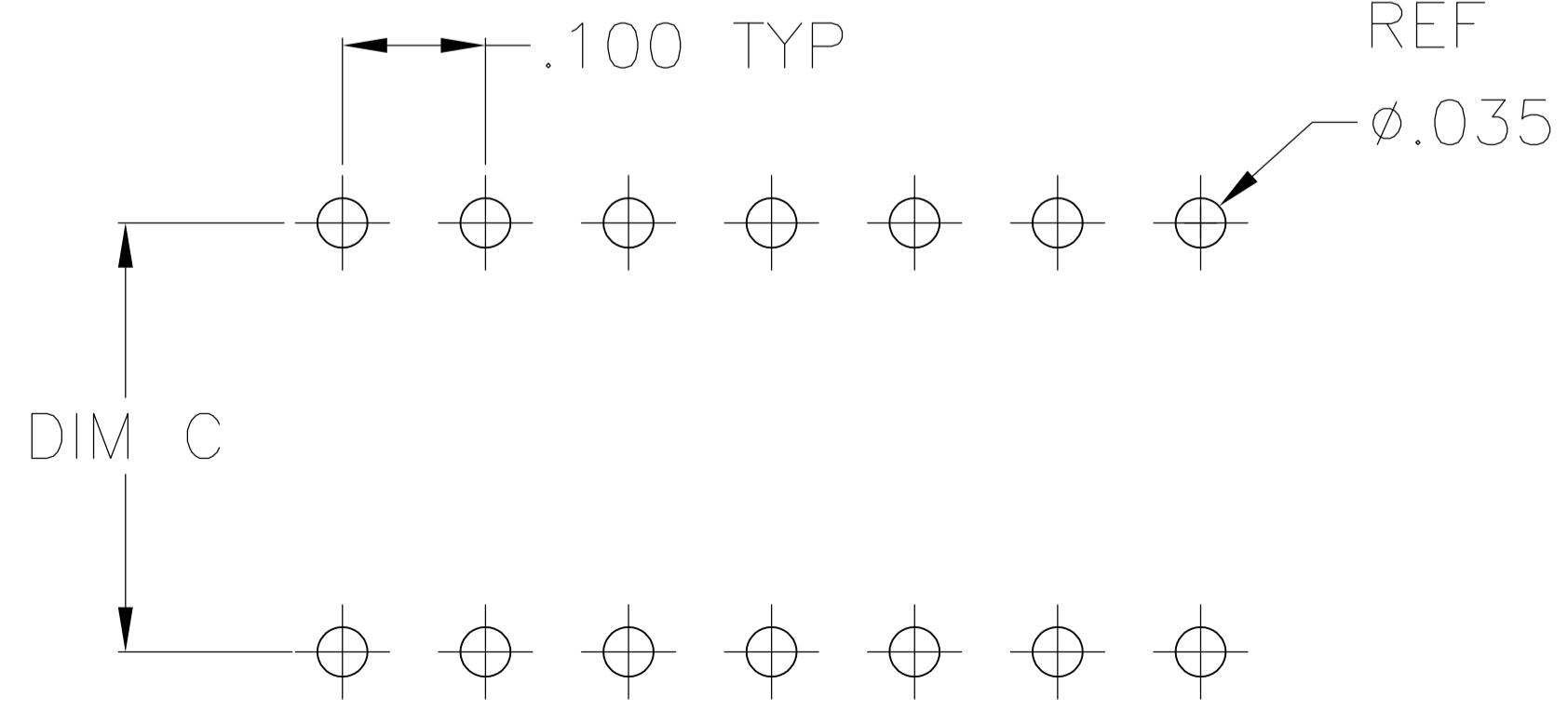

FIG. 3  
(8 POS ONLY)



.210/.180  
(STD .125 PC LEAD)  
.265/.235  
(LONG .180 PC LEAD)



P.C.B. HOLE LAYOUT  
TOLERANCE  $\pm .003$

1 **MATERIALS:**  
INSULATOR: POLYESTER, UL RATED 94V-0  
CONTACT:  
800 & 1800 SERIES CONTACT: 4 BEAM, COPPER ALLOY, MACHINED (PREMIUM VERSION) OR FORMED (ECONOMY VERSION, WITH SUFFIX -ES OR -ESL).  
800 SERIES HIGH RETENTION CONTACT: 4 BEAM, COPPER ALLOY, MACHINED.  
1000 SERIES CONTACT: 6 BEAM, COPPER ALLOY, MACHINED (LOW INSERTION FORCE SERIES)  
SLEEVE- ALL SERIES: COPPER ALLOY, FORMED

2 **ELECTRICAL:**  
CONTACT RESISTANCE: 10 MILLIOHMS MAX  
CONTACT RATING: 3 AMPS  
CAPACITANCE: 1.0 pF PER MIL-STD-202, METHOD 305  
INSULATION RESISTANCE: 5000 OHMS MIN @ 500 VDC PER MIL-STD-1344, METHOD 3003.1  
DIELECTRIC WITHSTANDING VOLTAGE: 1000 VOLTS (RMS) PER MIL-STD-1344, METHOD 3001.1

3 **MECHANICAL:**  
AFTER INSERTION FORCE: 37 GRAMS AVG (6 BEAM CONTACT) 134 GRAMS AVG (4 BEAM PREMIUM) 179 GRAMS AVG (4 BEAM ECONOMY) AND 334 GRAMS AVG (HIGH RETENTION)  
AFTER WITHDRAWAL FORCE: 15 GRAMS AVG (6 BEAM CONTACT) 63 GRAMS AVG (4 BEAM PREMIUM OR ECONOMY) AND 245 GRAMS AVG (HIGH RETENTION)

4 **ENVIRONMENTAL:**  
OPERATING TEMPERATURE: -55°C TO -105°C

5 **PLATING:** 25 $\mu$  MIN GOLD OVER 50 $\mu$  MIN NICKEL CONTACT WITH 5 $\mu$  MIN GOLD OVER 50 $\mu$  MIN NICKEL SLEEVE.

6 **PLATING:** 25 $\mu$  MIN GOLD OVER 50 $\mu$  MIN NICKEL CONTACT WITH 80 $\mu$  MIN TIN-LEAD OVER 50 $\mu$  MIN COPPER SLEEVE.

7 **PLATING:** 80 $\mu$  MIN TIN-LEAD OVER 75 $\mu$  MIN COPPER CONTACT WITH 180 $\mu$  MIN TIN-LEAD OVER 75 $\mu$  MIN NICKEL SLEEVE.

8 **PLATING:** 5 $\mu$  MIN GOLD FLASH OVER 50 $\mu$  MIN NICKEL CONTACT WITH 5 $\mu$  MIN GOLD FLASH OVER 50 $\mu$  MIN NICKEL SLEEVE.

9 **PLATING:** 5 $\mu$  MIN GOLD FLASH OVER 50 $\mu$  MIN NICKEL CONTACT WITH 80 $\mu$  MIN TIN-LEAD OVER 50 $\mu$  MIN COPPER SLEEVE.

10 **PLATING:** 7.5 $\mu$  MIN GOLD OVER 50 $\mu$  MIN NICKEL CONTACT WITH 80 $\mu$  MIN TIN-LEAD OVER 50 $\mu$  MIN COPPER SLEEVE.

11 PRELIMINARY PART - NOT RELEASED FOR PRODUCTION.

12 806-AGXXD-XXX SERIES IS SUPERSEDED BY 506-AGXXD-XXX SERIES (REFER TO CUSTOMER DRAWING 1437532-2)

13 **PLATING:** 25 $\mu$  MIN GOLD OVER 50 $\mu$  MIN NICKEL CONTACT WITH 80 $\mu$  MIN MATTE TIN OVER 50 $\mu$  MIN COPPER SLEEVE.

14 **PLATING:** 80 $\mu$  MIN MATTE TIN OVER 75 $\mu$  MIN COPPER CONTACT WITH 180 $\mu$  MIN MATTE TIN OVER 75 $\mu$  MIN NICKEL SLEEVE.

15 **PLATING:** 5 $\mu$  MIN GOLD FLASH OVER 50 $\mu$  MIN NICKEL CONTACT WITH 80 $\mu$  MIN MATTE TIN OVER 50 $\mu$  MIN COPPER SLEEVE.

16 **PLATING:** 7.5 $\mu$  MIN GOLD OVER 50 $\mu$  MIN NICKEL CONTACT WITH 80 $\mu$  MIN MATTE TIN OVER 50 $\mu$  MIN COPPER SLEEVE.

17 **OBsolete PARTS:** OBSOLETE CIS STREAMLINING PER D.RENAUD/D.SINISI

8 XX - AX XXX D - XXX - LF  
800 SERIES POSITIONS  
LF = LEAD FREE  
BLANK = MACHINED CONTACT  
ES = FORMED CONTACT, GOLD PLATE, NOTE 1  
ESL = FORMED CONTACT, LOW GOLD PLATE, 5 $\mu$ IN MAX  
D = PC TAIL STANDARD  
LSG STYLE AND TAIL CONFIGURATION  
AG = INSULATOR  
AR = INSULATOR WITH RAILS  
(ALMOST RUN THE LENGTH UNDER THE INSULATOR INSIDE THE CONTACT ROWS, .075 REF HIGH & .045 REF WIDE)

THIS DRAWING IS A CONTROLLED DOCUMENT.		DIN R BROWN 06MAY04	Tyco Electronics Tyco Electronics Corporation Harrisburg, Pa 17105-3608
DIMENSIONS: INCHES		CHK K WRIGHT 06MAY04	
TOLERANCES UNLESS OTHERWISE SPECIFIED:		APVD K WRIGHT 06MAY04	NAME
0 PLC	$\pm .005$	PRODUCT SPEC	DIP SOCKET, 800 SERIES
1 PLC	$\pm .005$	APPLICATION SPEC	SIZE CAGE CODE DRAWING NO
2 PLC	$\pm .005$	WEIGHT	A1 00779 ©=1437539-2
3 PLC	$\pm .005$	CUSTOMER DRAWING	SCALE 1:1 SHEET 1 OF 4 REV A3
4 PLC	$\pm .005$		
ANGLES	$\pm .005$		

### 800 SERIES MACHINED PREMIUM CONTACT LEAD FREE PART NUMBER TABLE

COMMENTS	PLATING	C	B	A	FIG	AUGAT PART NO.	TE PART NO.
HIGH RETENTION	13	.895/.905	1.000	3.200	2	864-AG34D-LF	5-6437538-4
HIGH RETENTION	13	.595/.605	.700	2.400	2	848-AG34D-LF	9-1437538-5
OBSOLETE W/RAILS	13					840-AR11D-LF	8-1437538-6
.180 PC LEAD	14	.595/.605	.700	2.000	2	840-AG43D-LF	8-1437538-4
HIGH RETENTION	13					840-AG34D-LF	8-1437538-3
HIGH RETENTION	14	.595/.605	.700	1.600	2	832-AG38D-LF	9-6437533-4
HIGH RETENTION	13					832-AG34D-LF	2-6437538-5
OBSOLETE W/RAILS	14					828-AR12D-LF	6-6437538-9
OBSOLETE W/RAILS	13	.595/.605	.700	1.400	1	828-AR11D-LF	1-6437538-6
.180 PC LEAD	14					828-AG43D-LF	6437538-4
OBSOLETE HIGH RETENTION	13					828-AG34D-LF	1-6437538-3
OBSOLETE W/RAILS	13	.295/.305	.400	1.200	1	824-AR31D-LF	5-6437538-1
OBSOLETE W/RAILS	13	.595/.605	.700	1.200	1	824-AR11D-LF	9-6437537-9
.180 PC LEAD	13	.295/.305	.400	1.200	1	824-AG47D-LF	9-6437537-7
OBSOLETE .180 PC LEAD	14	.395/.405	.500	1.200	1	824-AG446D-LF	9-6437537-6
HIGH RETENTION	13	.595/.605	.700	1.200	1	824-AG34D-LF	9-6437537-5
HIGH RETENTION	14					824-AG338D-LF	9-6437537-4
HIGH RETENTION	13	.295/.305	.400	1.200	1	824-AG334D-LF	9-6437537-3
.180 PC LEAD	14	.295/.305	.400	1.000	1	820-AG43D-LF	7-6437537-3
HIGH RETENTION	13					820-AG34D-LF	7-6437537-2
OBSOLETE .180 PC LEAD W/RAILS	13	.295/.305	.400	.900	1	818-AR44D-LF	4-6437539-9
OBSOLETE W/RAILS	13					818-AR11D-LF	6-6437537-2
OBSOLETE W/RAILS	13					816-AR11D-LF	5-6437537-4
HIGH RETENTION	13	.295/.305	.400	.800	1	816-AG34D-LF	5-6437537-1
OBSOLETE W/RAILS	13					814-AR11D-LF	3-6437537-5
.180 PC LEAD	14	.295/.305	.400	.700	1	814-AG43D-LF	3-6437537-2
HIGH RETENTION	13					814-AG34D-LF	3-6437537-1
OBSOLETE W/RAILS	13	.295/.305	.400	.400	3	808-AR11D-LF	1-6437537-9
.180 PC LEAD	14					808-AG43D-LF	6437537-5
HIGH RETENTION	13					808-AG34D-LF	6437537-4

### 800 SERIES MACHINED PREMIUM CONTACT PART NUMBER TABLE

COMMENTS	PLATING	C	B	A	FIG	AUGAT PART NO.	TE PART NO.
OBSOLETE W/RAILS	6	.295/.305	.400	1.200	1	824-AR31D	0-1437538-1
OBSOLETE W/RAILS	6	.595/.605	.700	1.200	1	824-AR11D	9-1437537-9
-	6	.395/.405	.500	1.200	1	824-AG66D	9-1437537-8
.180 PC LEAD	6	.295/.305	.400	1.200	1	824-AG47D	9-1437537-7
.180 PC LEAD	5	.595/.605	.700	1.200	1	824-AG45D	6-1437538-6
.180 PC LEAD	7	.395/.405	.500	1.200	1	824-AG446D	9-1437537-6
HIGH RETENTION	6	.595/.605	.700	1.200	1	824-AG34D	9-1437537-5
HIGH RETENTION	5					824-AG33D	8-1437539-2
HIGH RETENTION	7					824-AG338D	9-1437537-4
HIGH RETENTION	6					824-AG334D	9-1437537-3
-	7	.295/.305	.400	1.200	1	824-AG32D	9-1437537-2
-	6					824-AG31D	8-1437537-9
-	5					824-AG30D	8-1437537-7
-	7	.395/.405	.500	1.200	1	824-AG14D	8-1437537-6
-	7					824-AG12D	8-1437537-5
-	6	.595/.605	.700	1.200	1	824-AG11D	8-1437537-2
-	5					824-AG10D	8-1437537-1
-	6	.295/.305	.400	1.100	1	822-AG11D	7-1437537-8
-	5					822-AG10D	7-1437537-7
OBSOLETE W/RAILS	6					820-AR11D	7-1437537-6
.180 PC LEAD	5					820-AG45D	7-1437537-5
.180 PC LEAD	6					820-AG44D	7-1437537-4
.180 PC LEAD	7	.295/.305	.400	1.000	1	820-AG43D	7-1437537-3
HIGH RETENTION	6					820-AG34D	7-1437537-2
-	7					820-AG12D	6-1437537-9
-	6					820-AG11D	6-1437537-6
-	5					820-AG10D	6-1437537-4
.180 PC LEAD W/RAILS	6	.295/.305	.400	.900	1	818-AR44D	4-1437539-9
W/RAILS	6					818-AR11D	6-1437537-2
.180 PC LEAD	6					818-AG44D	6-1437537-1
HIGH RETENTION S/B 5-1437537-7	6					818-AG34D	5-1437538-8
-	7					818-AG12D	6-1437537-0
-	6					818-AG11D	5-1437537-7
-	5					818-AG10D	5-1437537-6
W/RAILS	6					816-AR11D	5-1437537-4
.180 PC LEAD	5	.295/.305	.400	.800	1	816-AG45D	5-1437537-3
.180 PC LEAD	6					816-AG44D	5-1437537-2
HIGH RETENTION	6					816-AG34D	5-1437537-1
HIGH RETENTION	5					816-AG33D	5-1437537-0
-	7					816-AG12D	4-1437537-6
-	6					816-AG11D	4-1437537-0
-	5					816-AG10D	3-1437537-7
.180 PC LEAD, W/RAILS S/B 3-1437537-3	6					814-AR44D	5-1437533-2
W/RAILS	6					814-AR11D	3-1437537-5
.180 PC LEAD	5	.295/.305	.400	.700	1	814-AG45D	3-1437537-4
.180 PC LEAD	6					814-AG44D	3-1437537-3
.180 PC LEAD	7					814-AG34D	3-1437537-2
HIGH RETENTION	6					814-AG33D	3-1437537-1
-	7					814-AG12D	2-1437537-9
-	6					814-AG11D	2-1437537-4
-	5					814-AG10D	2-1437537-1
W/RAILS	6					808-AR11D	1-1437537-9
.180 PC LEAD	5	.295/.305	.400	.400	3	808-AG45D	1-1437537-8
.180 PC LEAD	6					808-AG44D	1-1437537-7
.180 PC LEAD	7					808-AG43D	1-1437537-5
HIGH RETENTION	6					808-AG34D	1-1437537-4
-	7					808-AG12D	1-1437537-2
-	6					808-AG11D	0-1437537-8
-	5					808-AG10D	0-1437537-5
S/B 6-1437529-8	6	.295/.305	.400	.300	-	806-AG11D	2-1437533-5
SUPERSEDED BY 6-1437529-5	5					806-AG10D	2-1437533-3

### 800 SERIES MACHINED PREMIUM CONTACT PART NUMBER TABLE

COMMENTS	PLATING	C	B	A	FIG	AUGAT PART NO.	TE PART NO.
OBSOLETE HIGH RETENTION	6	.895/.905	1.000	3.200	2	864-AG34D	5-1437538-4
-	7					864-AG12D	5-1437538-2
-	6					864-AG11D	4-1437538-8
-	5					864-AG10D	3-1437540-1
OBSOLETE W/RAILS	6					848-AR11D	4-1437538-6
OBSOLETE HIGH RETENTION	6	.595/.605	.700	2.400	2	848-AG34D	4-1437538-5
-	7					848-AG12D	4-1437538-4
-	6					848-AG11D	4-1437538-1
OBSOLETE	5	.595/.605	.700	2.100	2	848-AG10D	3-1437538-9
OBSOLETE	7					842-AG12D	3-1437538-8
OBSOLETE	6					842-AG11D	3-1437538-7
OBSOLETE W/RAILS	6					840-AR11D	3-1437538-6
.180 PC LEAD	6	.595/.605	.700	2.000	2	840-AG44D	3-1437538-5
.180 PC LEAD	7					840-AG43D	3-1437538-4
HIGH RETENTION	6					840-AG34D	3-1437538-3
-	7					840-AG12D	3-1437538-2
-	6					840-AG11D	3-1437538-0
-	5	.595/.605	.700	1.800	2	840-AG10D	2-1437538-9
-	6					836-AG11D	2-1437538-7
S/B 2-1437528-4	7					832-AR12D	9-1437533-7
OBSOLETE HIGH RETENTION	7	.595/.605	.700	1.600	2	832-AG38D	9-1437533-4
HIGH RETENTION	6					832-AG34D	2-1437538-5
-	7					832-AG12D	2-1437538-4
-	6					832-AG11D	2-1437538-2
-	5					832-AG10D	2-1437538-1
W/RAILS	7					828-AR12D	6-1437538-9
OBSOLETE W/RAILS	6					828-AR11D	1-1437538-6
OBSOLETE .180 PC LEAD	6	.595/.605	.700	1.400	1	828-AG44D	1-1437538-5
OBSOLETE .180 PC LEAD	7					828-AG43D	1-1437538-4
HIGH RETENTION	6					828-AG34D	1-1437538-3
-	7					828-AG12D	1-1437538-0
-	6					828-AG11D	0-1437538-4
-	5					828-AG10D	0-1437538-3

THIS DRAWING IS A CONTROLLED DOCUMENT.

DIN R BROWN 06MAY04  
 CHK K WRIGHT 06MAY04  
 APVO K WRIGHT 06MAY04

Tyco Electronics Tyco Electronics Corporation  
 Harrisburg, Pa 17105-3608

PRODUCT SPEC  
 APPLICATION SPEC  
 NAME  
 SIZE CASE CODE DRAWING NO  
 WEIGHT  
 A1 00779 1437539-2

DIP SOCKET, 800 SERIES

MATERIAL FINISH  
 WEIGHT  
 CUSTOMER DRAWING SCALE 1:1 SHEET 2 OF 4 REV A3

### 800 SERIES STAMPED ECONOMY CONTACT LEAD FREE PART NUMBER TABLE

OBSOLETE	W/RAILS	PLATING	C	B	A	FIG	AUGAT PART NO.	TE PART NO.
OBSOLETE	W/RAILS	13	.595/.605	.700	2.400	2	848-AR11D-ES-LF	8-1437540-0
OBSOLETE	W/RAILS	14					840-AR12D-ES-LF	6-6447099-8
OBSOLETE	W/RAILS	15					840-AR11D-ESL-LF	7-1437540-2
OBSOLETE	W/RAILS	13	.595/.605	.700	2.000	2	840-AR11D-ES-LF	7-1437540-1
	.180 PC LEAD	15					840-AG44D-ESL-LF	7-1437540-0
OBSOLETE	W/RAILS	15					832-AR11D-ESL-LF	0-6437540-9
OBSOLETE	W/RAILS	13					832-AR11D-ES-LF	0-6437540-8
	.180 PC LEAD	13	.595/.605	.700	1.600	2	832-AG44D-ES-LF	0-6437540-7
	.180 PC LEAD	14					832-AG43D-ES-LF	0-6437540-6
OBSOLETE	.180 PC LEAD W/RAILS	15					828-AR44D-ESL-LF	9-6437539-8
OBSOLETE	W/RAILS	14					828-AR12D-ES-LF	6-6447099-7
OBSOLETE	W/RAILS	13	.595/.605	.700	1.400	1	828-AR11D-ES-LF	9-6437539-6
	.180 PC LEAD	13					828-AG44D-ES-LF	9-6437539-5
OBSOLETE	.180 PC LEAD W/RAILS	15	.295/.305	.400	1.200	1	824-AR47D-ESL-LF	8-6437533-3
OBSOLETE	W/RAILS	13	.295/.305	.400	1.200	1	824-AR31D-ES-LF	8-6437539-7
OBSOLETE	W/RAILS	14	.595/.605	.700	1.200	1	824-AR12D-ES-LF	6-6447099-6
	.180 PC LEAD	13	.595/.605	.700	1.200	1	824-AG44D-ESL-LF	8-6437539-3
	.180 PC LEAD	15	.295/.305	.400	1.100	1	822-AG44D-ES-LF	6-6437539-5
	.180 PC LEAD	13	.295/.305	.400	1.000	1	820-AR11D-ESL-LF	5-6437539-8
OBSOLETE	W/RAILS	15					820-AR11D-ES-LF	5-6437539-7
OBSOLETE	W/RAILS	13					816-AR11D-ESL-LF	3-6437539-5
OBSOLETE	W/RAILS	15					816-AR11D-ES-LF	3-6437539-4
	.180 PC LEAD	13	.295/.305	.400	.800	1	816-AG44D-ESL-LF	3-6437539-2
OBSOLETE	W/RAILS	13	.295/.305	.400	.700	1	814-AR11D-ES-LF	2-6437539-2
OBSOLETE	W/RAILS	14					808-AR11D-ES-LF	1-6437539-0
	.180 PC LEAD	14	.295/.305	.400	.400	1	808-AG43D-ES-LF	6437537-6
	COMMENTS	PLATING	C	B	A	FIG	AUGAT PART NO.	TE PART NO.

### 800 SERIES STAMPED ECONOMY CONTACT PART NUMBER TABLE

OBSOLETE	W/RAILS	PLATING	C	B	A	FIG	AUGAT PART NO.	TE PART NO.
OBSOLETE	W/RAILS	9	.295/.305	.400	1.200	1	824-AR47D-ESL	8-1437533-3
SUPERSEDED	.180 PC LEAD W/RAILS S/B 8-1437539-3	9	.595/.605	.700	1.200	1	824-AR44D-ESL	8-1437533-2
	W/RAILS	9	.295/.305	.400	1.200	1	824-AR31D-ESL	3-1437540-9
	W/RAILS	6					824-AR31D-ES	8-1437539-7
OBSOLETE	W/RAILS	7					824-AR12D-ES	6-1447099-6
OBSOLETE	W/RAILS	9	.595/.605	.700	1.200	1	824-AR11D-ESL	8-1437539-6
OBSOLETE	W/RAILS	6					824-AR11D-ES	8-1437539-5
OBSOLETE	-	9	.395/.405	.500	1.200	1	824-AG66D-ESL	8-1437539-4
	.180 PC LEAD	5					824-AG65D-ES	0-1571180-1
OBSOLETE	.180 PC LEAD	9	.595/.605	.700	1.200	1	824-AG44D-ESL	8-1437539-3
	-	7					824-AG32D-ES	8-1437539-1
	-	9					824-AG31D-ESL	7-1437539-7
	-	6	.295/.305	.400	1.200	1	824-AG31D-ES	7-1437539-6
	-	8					824-AG30D-ESL	7-1437539-4
	-	5					824-AG30D-ES	7-1437539-3
	-	7					824-AG12D-ES	7-1437539-2
	-	9	.595/.605	.700	1.200	1	824-AG11D-ESL	7-1437539-0
	-	6					824-AG11D-ES	6-1437539-9
OBSOLETE	.180 PC LEAD	5					824-AG10D-ES	6-1437539-7
	-	7					822-AG44D-ES	6-1437539-5
	-	9	.295/.305	.400	1.100	1	822-AG12D-ES	6-1437539-4
	-	6					822-AG11D-ESL	6-1437539-3
	-	5					822-AG11D-ES	6-1437539-2
OBSOLETE	.180 PC LEAD W/RAILS S/B 7-1437537-4	9					820-AR44D-ESL	7-1437533-1
OBSOLETE	W/RAILS	9					820-AR11D-ESL	5-1437539-8
OBSOLETE	W/RAILS	6	.295/.305	.400	1.000	1	820-AR11D-ES	5-1437539-7
	.180 PC LEAD S/B 7-1437537-4	9					820-AG44D-ES	7-1437533-0
	-	7					820-AG12D-ES	5-1437539-6
	-	9					820-AG11D-ESL	5-1437539-3
	-	6					820-AG11D-ES	5-1437539-2
	W/RAILS	5					820-AG10D-ES	5-1437539-0
OBSOLETE	.180 PC LEAD W/RAILS S/B 4-1437539-9	9					818-AR44D-ESL	6-1437533-4
OBSOLETE	W/RAILS	9					818-AR11D-ESL	4-1437539-8
OBSOLETE	W/RAILS	6					818-AR11D-ES	4-1437539-7
	.180 PC LEAD S/B 6-1437537-1	9	.295/.305	.400	.900	1	818-AG44D-ESL	6-1437533-3
	-	7					818-AG12D-ES	4-1437539-6
	-	9					818-AG11D-ESL	4-1437539-4
	-	6					818-AG11D-ES	4-1437539-3
OBSOLETE	W/RAILS	5					818-AG10D-ES	4-1437539-1
OBSOLETE	W/RAILS	9					816-AR11D-ESL	3-1437539-5
OBSOLETE	W/RAILS	6					816-AR11D-ES	3-1437539-4
OBSOLETE	.180 PC LEAD	5	.295/.305	.400	.800	1	816-AG45D-ES	3-1437539-3
OBSOLETE	.180 PC LEAD	9					816-AG44D-ESL	3-1437539-2
	-	7					816-AG12D-ES	3-1437539-1
	-	9					816-AG11D-ESL	2-1437539-9
	-	6					816-AG11D-ES	2-1437539-8
	-	5					816-AG10D-ES	2-1437539-6
OBSOLETE	.180 PC LEAD, W/RAILS S/B 3-1437537-3	9					814-AR44D-ESL	5-1437533-3
OBSOLETE	W/RAILS	9					814-AR11D-ESL	2-1437539-3
OBSOLETE	W/RAILS	6					814-AR11D-ES	2-1437539-2
SUPERSEDED	.180 PC LEAD S/B 3-1437537-3	9	.295/.305	.400	.700	1	814-AG45D-ES	2-1437539-1
	-	7					814-AG44D-ESL	4-1437540-5
	-	9					814-AG12D-ES	2-1437539-0
	-	6					814-AG11D-ESL	1-1437539-7
	-	5					814-AG11D-ES	1-1437539-6
	-	9					814-AG10D-ES	1-1437539-4
OBSOLETE	.180 PC W/RAILS, S/B 1437539-9	9					808-AR44D-ESL	3-1437533-1
OBSOLETE	W/RAILS	9					808-AR11D-ESL	1-1437539-1
OBSOLETE	W/RAILS	6					808-AR11D-ES	1-1437539-0
OBSOLETE	.180 PC LEAD	9	.295/.305	.400	.400	1	808-AG44D-ESL	0-1437539-9
OBSOLETE	.180 PC LEAD	7					808-AG43D-ES	1-1437537-6
	-	7					808-AG12D-ES	0-1437539-8
	-	9					808-AG11D-ESL	0-1437539-6
	-	6					808-AG11D-ES	0-1437539-5
	-	5					808-AG10D-ES	0-1437539-2
	S/B 7-1437529-1	7					806-AG12D-ES	2-1437533-8
	S/B 1437535-8	9	.295/.305	.400	.300	1	806-AG11D-ESL	8-1437536-5
	S/B 1437535-7	6					806-AG11D-ES	2-1437533-7
	COMMENTS	PLATING	C	B	A	FIG	AUGAT PART NO.	TE PART NO.

### 800 SERIES STAMPED ECONOMY CONTACT PART NUMBER TABLE

OBSOLETE	W/RAILS	PLATING	C	B	A	FIG	AUGAT PART NO.	TE PART NO.
OBSOLETE	-	7					864-AG12D-ES	5-1437538-3
	-	9	.895/.905	1.000	3.200	2	864-AG11D-ESL	5-1437538-0
	-	6					864-AG11D-ES	4-1437538-9
OBSOLETE	-	5					864-AG10D-ES	3-1437540-2
OBSOLETE	W/RAILS	9					848-AR11D-ESL	6-1437540-2
OBSOLETE	W/RAILS	6					848-AR11D-ES	3-1437540-0
	-	7	.595/.605	.700	2.400	2	848-AG12D-ES	2-1437540-8
	-	9					848-AG11D-ESL	4-1437538-2
OBSOLETE	-	6					848-AG11D-ES	2-1437540-6
	-	9	.595/.605	.700	2.100	2	848-AG10D-ES	2-1437540-5
	-	9					842-AG11D-ESL	2-1437540-4
	.180 PC LEAD W/RAILS S/B 2-1437540-0	6					842-AG11D-ES	2-1437540-3
OBSOLETE	W/RAILS	7					840-AR44D-ESL	0-1437534-7
OBSOLETE	W/RAILS	9					840-AR12D-ES	6-1447099-8
OBSOLETE	W/RAILS	6					840-AR11D-ESL	2-1437540-2
	.180 PC LEAD	9	.595/.605	.700	2.000	2	840-AR11D-ES	2-1437540-1
	-	7					840-AG44D-ESL	2-1437540-0
	-	9					840-AG12D-ES	1-1437540-9
	-	6					840-AG11D-ESL	1-1437540-7
	-	5					840-AG11D-ES	1-1437540-6
OBSOLETE	-	9	.595/.605	.700	1.800	2	840-AG10D-ES	1-1437540-4
	-	7					836-AG12D-ES	1-1437540-2
	-	9					836-AG11D-ESL	1-1437540-1
	-	6					836-AG11D-ES	1-1437540-0
OBSOLETE	W/RAILS	9					832-AR11D-ESL	0-1437540-9
OBSOLETE	W/RAILS	6					832-AR11D-ES	0-1437540-8
	.180 PC LEAD S/B 1437540-1	8					832-AG45D-ESL	6-1437538-0
	.180 PC LEAD S/B 1437540-7	9	.595/.605	.700	1.600	2	832-AG44D-ESL	9-1437533-5
OBSOLETE	.180 PC LEAD	6					832-AG44D-ES	0-1437540-7
	-	7					832-AG43D-ES	0-1437540-6
	-	9					832-AG12D-ES	0-1437540-5
	-	6					832-AG11D-ESL	0-1437540-3
	-	5					832-AG11D-ES	0-1437540-2
OBSOLETE	.180 PC LEAD W/RAILS	9					832-AG10D-ES	0-1437540-1
OBSOLETE	W/RAILS	7					828-AR44D-ESL	9-1437539-8
OBSOLETE	W/RAILS	9					828-AR12D-ES	6-1447099-7
OBSOLETE	W/RAILS	6					828-AR11D-ESL	9-1437539-7
OBSOLETE	W/RAILS	9					828-AR11D-ES	9-1437539-6
OBSOLETE	.180 PC LEAD	6	.595/.605	.700	1.400	1	828-AG44D-ES	9-1437539-5
	-	7					828-AG12D-ES	9-1437539-4
	-	9					828-AG11D-ESL	9-1437539-2
	-	6					828-AG11D-ES	9-1437539-1
	-	5					828-AG10D-ES	8-1437539-9
	COMMENTS	PLATING	C	B	A	FIG	AUGAT PART NO.	TE PART NO.

THIS DRAWING IS A CONTROLLED DOCUMENT.

DIN R BROWN 06MAY04  
 CHK K WRIGHT 06MAY04  
 NAME K WRIGHT 06MAY04

Tyco Electronics  
 Tyco Electronics Corporation  
 Harrisburg, Pa 17105-3608

DIP SOCKET, 800 SERIES

APPROVED: K WRIGHT  
 PRODUCT SPEC

APPLICATION SPEC

SIZE: A1 CASE CODE: 00779 DRAWING NO: 1437539-2  
 WEIGHT: -

MATERIAL: - FINISH: -

CUSTOMER DRAWING SCALE: 1:1 SHEET: 3 OF 4 REV: A3

### 1000 SERIES MACHINED PREMIUM CONTACT, LOW INSERTION FORCE PART NUMBER TABLE

COMMENTS	PLATING	C	B	A	FIG	AUGAT PART NO.	TE PART NO.
S/B 4-1437538-8	6	.895/.905	1.000	3.200	2	1064-AG11D	2-1437529-4
S/B 3-1437540-1	5	.895/.905	1.000	3.200	2	1064-AG10D	2-1437529-3
S/B 3-1437538-0	6	.595/.605	.700	2.000	2	1040-AG11D	2-1437529-2
S/B 2-1437538-2	6	.595/.605	.700	1.600	2	1032-AG11D	2-1437529-1
S/B 1437538-4	6	.595/.605	.700	1.400	1	1028-AG11D	1-1437529-9
S/B 8-1437537-9	6	.295/.305	.400	1.200	1	1024-AG31D	1-1437529-8
S/B 8-1437537-2	6	.595/.605	.700	1.200	1	1024-AG11D	1-1437529-6
S/B 8-1437537-1	5	.595/.605	.700	1.200	1	1024-AG10D	1-1437529-5
S/B 6-1437537-6	6	.295/.305	.400	1.000	1	1020-AG11D	1-1437529-4
S/B 6-1437537-4	5	.295/.305	.400	1.000	1	1020-AG10D	1-1437529-3
S/B 5-1437537-7	6	.295/.305	.400	.900	1	1018-AG11D	1-1437529-2
S/B 5-1437537-6	5	.295/.305	.400	.900	1	1018-AG10D	1-1437529-1
S/B 4-1437537-0	6	.295/.305	.400	.800	1	1016-AG11D	1-1437529-0
S/B 3-1437537-7	5	.295/.305	.400	.800	1	1016-AG10D	0-1437529-9
S/B 2-1437537-4	6	.295/.305	.400	.700	1	1014-AG11D	0-1437529-7
S/B 2-1437537-1	5	.295/.305	.400	.700	1	1014-AG10D	0-1437529-6
S/B 1437537-8	6	.295/.305	.400	.400	3	1008-AG11D	0-1437529-5
S/B 1437537-5	5	.295/.305	.400	.400	3	1008-AG10D	0-1437529-4

### 1800 SERIES MACHINED PREMIUM CONTACT, LOW GOLD PART NUMBER TABLE

	S/B 5-1437538-0	10	.895/.905	1.000	3.200	2	1864-AG111D	5-1437529-1
	S/B 6-1437540-2 W/RAILS	10	.595/.605	.700	2.400	2	1848-AR111D	5-1437529-0
	S/B 4-1437538-2	10	.595/.605	.700	2.100	2	1848-AG111D	4-1437529-9
	S/B 2-1437540-4	10	.595/.605	.700	2.100	2	1842-AG111D	4-1437529-8
	S/B 2-1437540-2 W/RAILS	10	.595/.605	.700	2.000	2	1840-AR111D	4-1437529-7
	S/B 1-1437540-7	10	.595/.605	.700	2.000	2	1840-AG111D	4-1437529-6
	S/B 1437540-3	10	.595/.605	.700	1.600	2	1832-AG111D	4-1437529-5
	S/B 9-1437539-7 W/RAILS	10	.595/.605	.700	1.400	1	1828-AR111D	4-1437529-4
	S/B 9-1437539-2	10	.595/.605	.700	1.400	1	1828-AG111D	4-1437529-3
	S/B 3-1437540-9 W/RAILS	10	.295/.305	.400	1.200	1	1824-AR131D	4-1437529-2
OBSOLETE	S/B 8-1437539-6 W/RAILS	10	.595/.605	.700	1.200	1	1824-AR111D	4-1437529-1
OBSOLETE	S/B 8-1437539-4	10	.395/.405	.500	1.200	1	1824-AG141D	4-1437529-0
	S/B 7-1437539-7	10	.295/.305	.400	1.200	1	1824-AG131D	3-1437529-9
	S/B 7-1437539-0	10	.595/.605	.700	1.200	1	1824-AG111D	3-1437529-8
	S/B 6-1437539-3	10	.395/.405	.500	1.100	1	1822-AG111D	3-1437529-7
	S/B 5-1437539-8 W/RAILS	10	.295/.305	.400	1.000	1	1820-AR111D	3-1437529-6
SUPERSEDED	S/B 5-1437539-3	10	.295/.305	.400	1.000	1	1820-AG111D	3-1437529-5
	S/B 4-1437539-8 W/RAILS	10	.295/.305	.400	.900	1	1818-AR111D	3-1437529-5
	S/B 4-1437539-4	10	.295/.305	.400	.900	1	1818-AG111D	3-1437529-3
OBSOLETE	S/B 3-1437539-5 W/RAILS	10	.295/.305	.400	.800	1	1816-AR111D	3-1437529-2
	S/B 2-1437539-9	10	.295/.305	.400	.800	1	1816-AG111D	3-1437529-1
	S/B 2-1437539-3 W/RAILS	10	.295/.305	.400	.700	1	1814-AR111D	3-1437529-0
	S/B 1-1437539-7	10	.295/.305	.400	.700	1	1814-AG111D	2-1437529-9
	S/B 1-1437539-1 W/RAILS	10	.295/.305	.400	.400	3	1808-AR111D	2-1437529-6
	S/B 1437539-6	10	.295/.305	.400	.400	3	1808-AG111D	2-1437529-5
OBSOLETE	S/B 1437539-8	10	.295/.305	.400	.300		1806-AG111D	0-1437535-2

THIS DRAWING IS A CONTROLLED DOCUMENT.

DIMENSIONS: INCHES	TOLERANCES UNLESS OTHERWISE SPECIFIED:	DIN R BROWN 06MAY04	Tyco Electronics Corporation Harrisburg, Pa 17105-3608
	0 PLC ± - 1 PLC ± - 2 PLC ± - 3 PLC ± .005 4 PLC ± - ANGLES ± -	CHK K WRIGHT 06MAY04	
MATERIAL	FINISH	APVD K WRIGHT 06MAY04	NAME
		APPLICATION SPEC	DIP SOCKET, 800 SERIES
		WEIGHT	SIZE CASE CODE DRAWING NO
			A1 00779 1437539-2
		CUSTOMER DRAWING	RESTRICTED TO
		SCALE 1:1	SHEET 4 OF 4

## Looking for pricing, stock, or lifecycle information?

Click below to explore more details on WIN SOURCE:

 [View 1-1437540-7 on WIN SOURCE](#)

 [TE Connectivity](#) Information

## Optimize Your Supply Chain with WIN SOURCE Solutions

-  Global Sourcing Solution
-  Obsolete Management
-  Cost Control Management
-  Shortage Management
-  Alternative Solution
-  Excess Inventory Management