



THE DATASHEET OF HMC336MS8GETR



GaAs MMIC SPDT NON-REFLECTIVE POSITIVE CONTROL SWITCH, DC* - 6 GHz



Typical Applications

This switch is suitable for usage in DC - 6.0 GHz 50-Ohm or 75-Ohm systems:

- Broadband
- Fiber Optics
- Switched Filter Banks
- Wireless below 6.0 GHz

Features

- Broadband Performance: DC - 6 GHz
- High Isolation: 42 dB@ 6 GHz
- Low Insertion Loss: 1.6 dB@ 6 GHz
- MSOP8G SMT Package

Functional Diagram

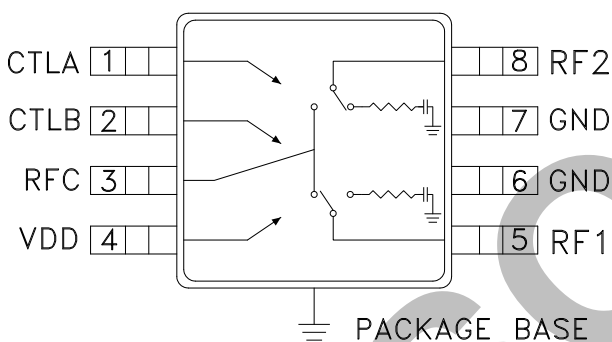

General Description

The HMC336MS8G & HMC336MS8GE are broadband non-reflective GaAs MESFET SPDT switches in low cost 8-lead MSOP8G surface mount packages with an exposed ground paddle. Covering DC to 6 GHz, this switch offers high isolation and low insertion loss. The switch operates using a positive control voltage of 0/+5 Volts, and requires a fixed bias of +5V. This switch is suitable for usage in 50-Ohm or 75-Ohm systems.

10

SWITCHES - SMT

Electrical Specifications, $T_A = +25^\circ \text{C}$, With 0/+5V Control, 50 Ohm System

Parameter	Frequency	Min.	Typ.	Max.	Units
Insertion Loss	DC - 2.0 GHz		1.2	1.6	dB
	DC - 4.0 GHz		1.4	1.8	dB
	DC - 6.0 GHz		1.6	2.0	dB
Isolation	DC - 2.0 GHz	42	47		dB
	DC - 4.0 GHz	39	44		dB
	DC - 6.0 GHz	37	42		dB
Return Loss	"On State"	DC - 2.0 GHz	9	12	dB
		DC - 6.0 GHz	6	9	dB
Return Loss (RF1, RF2)	"Off State"	2.0 - 6.0 GHz	13	18	dB
Input Power for 1 dB Compression	0.5 - 6.0 GHz	20	25		dBm
Input Third Order Intercept (Two-Tone Input Power = +7 dBm Each Tone, 1 MHz Tone Spacing)	0.5 - 6.0 GHz	37	42		dBm
Switching Characteristics	DC - 6.0 GHz	tRISE, tFALL (10/90% RF)	8		ns
		tON, tOFF (50% CTL to 10/90% RF)	20		ns

* DC blocking capacitors are required at ports RFC, RF1 and RF2. Their value will determine the lowest transmission frequency.



Insertion Loss vs. Temperature

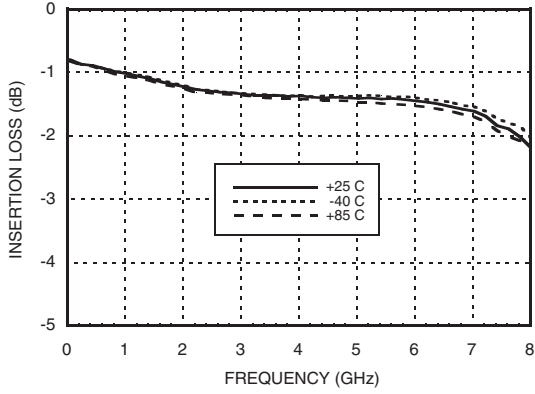

Isolation

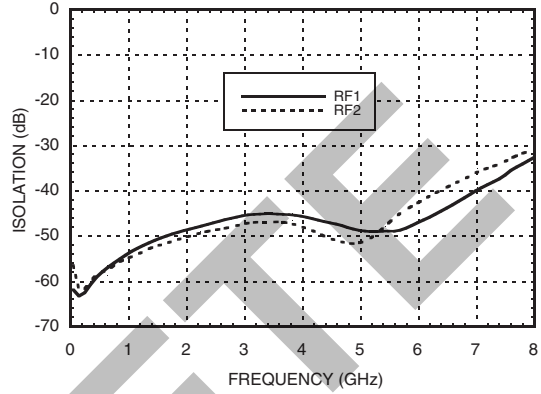

Return Loss

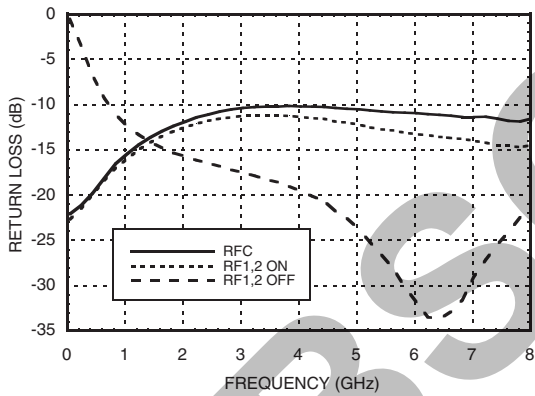

0.1 and 1 dB Input Compression Point

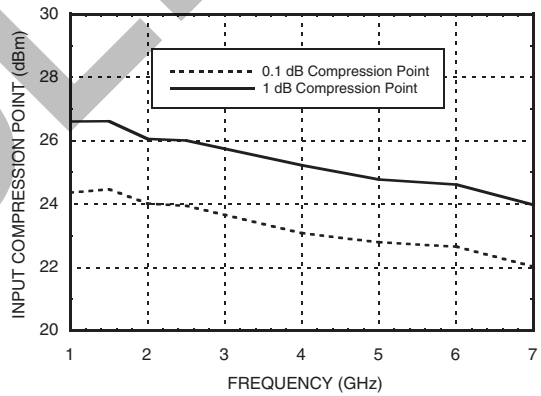

Input Third Order Intercept Point

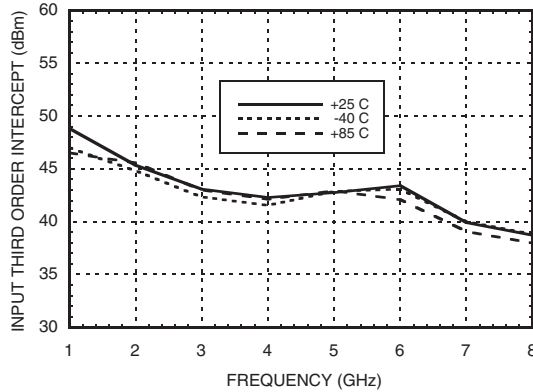

Information furnished by Analog Devices is believed to be accurate and reliable. However, no responsibility is assumed by Analog Devices for its use, nor for any infringements of patents or other rights of third parties that may result from its use. Specifications subject to change without notice. No license is granted by implication or otherwise under any patent or patent rights of Analog Devices. Trademarks and registered trademarks are the property of their respective owners.

For price, delivery, and to place orders: Analog Devices, Inc., One Technology Way, P.O. Box 9106, Norwood, MA 02062-9106 Phone: 781-329-4700 • Order online at www.analog.com Application Support: Phone: 1-800-ANALOG-D

**GaAs MMIC SPDT NON-REFLECTIVE
POSITIVE CONTROL SWITCH, DC* - 6 GHz**

Absolute Maximum Ratings

Bias Voltage Range (Vdd)	+7.0 Vdc
Control Voltage Range (A & B)	-0.5V to Vdd +1.0 Vdc
Storage Temperature	-65 to +150 °C
Operating Temperature	-40 to +85 °C
Maximum Input Power	+28 dBm
ESD Sensitivity (HBM)	Class 1A

Note:

DC blocking capacitors are required at ports RFC and RF1, 2. Their value will determine the lowest transmission frequency.



**ELECTROSTATIC SENSITIVE DEVICE
OBSERVE HANDLING PRECAUTIONS**

Bias Voltage & Current

Vdd (Vdc)	Idd (Typ.) (µA)	Idd (Max.) (µA)
+5.0	35	100

Control Voltages

State	Bias Condition
Low	0 to 0.2 Vdc @ 35 µA Typical
High	+5 Vdc @ 10 µA Typical

Truth Table

Control Input		Signal Path State
A	B	RFCOM to:
Low	High	RF1
High	Low	RF2

OBSOLETE

GaAs MMIC SPDT NON-REFLECTIVE POSITIVE CONTROL SWITCH, DC* - 6 GHz



Outline Drawing

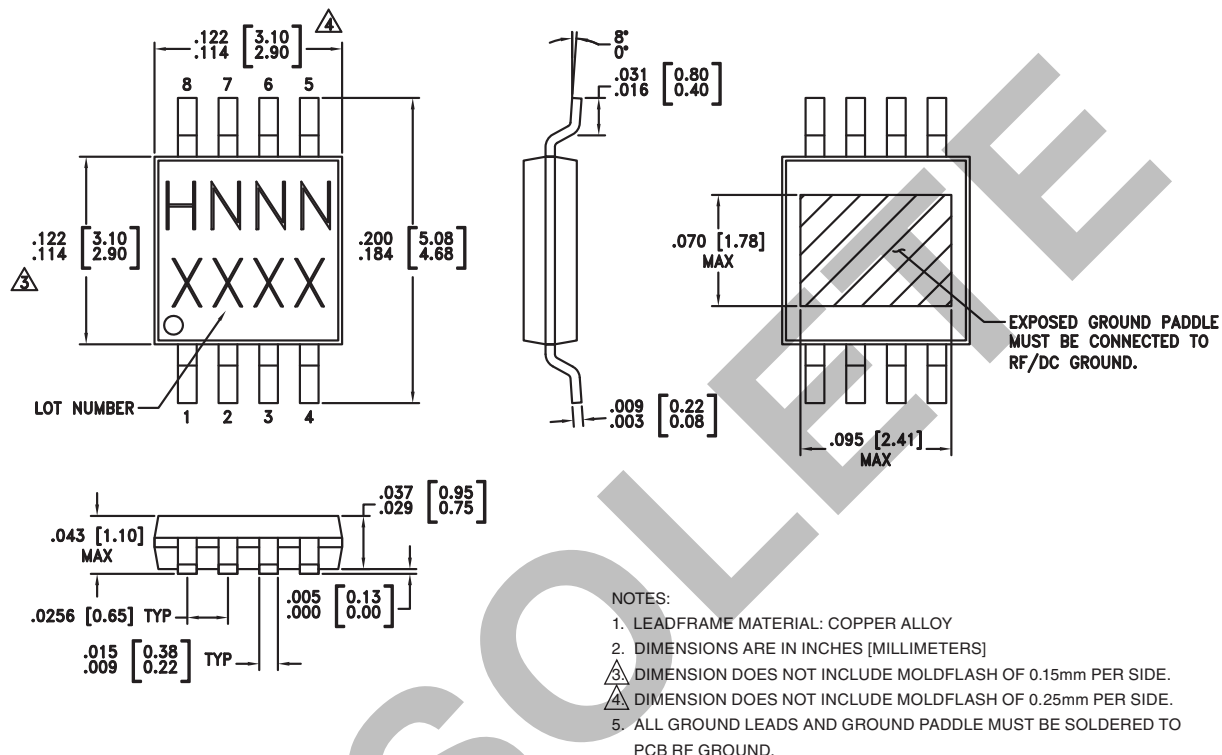

Package Information



Part Number	Package Body Material	Lead Finish	MSL Rating	Package Marking ^[3]
HMC336MS8G	Low Stress Injection Molded Plastic	Sn/Pb Solder	MSL1 ^[1]	H336 XXXX
HMC336MS8GE	RoHS-compliant Low Stress Injection Molded Plastic	100% matte Sn	MSL1 ^[2]	H336 XXXX

[1] Max peak reflow temperature of 235 °C
 [2] Max peak reflow temperature of 260 °C
 [3] 4-Digit lot number XXXX

GaAs MMIC SPDT NON-REFLECTIVE POSITIVE CONTROL SWITCH, DC* - 6 GHz

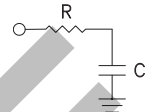
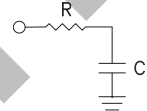

Pin Descriptions

Pin Number	Function	Description	Interface Schematic
1	CTLA	See truth table and control voltage table.	
2	CTLB	See truth table and control voltage table.	
3, 5, 8	RFC, RF1, RF2	This pin is DC coupled and matched to 50 Ohm. Blocking capacitors are required.	
4	VDD	Supply Voltage. This pin may be left floating with degradation of power performance by approximately 1.5 dB.	
6, 7	GND	Package bottom has exposed metal paddle that must also be connected to PCB RF ground.	

OBSOLETE



Evaluation PCB

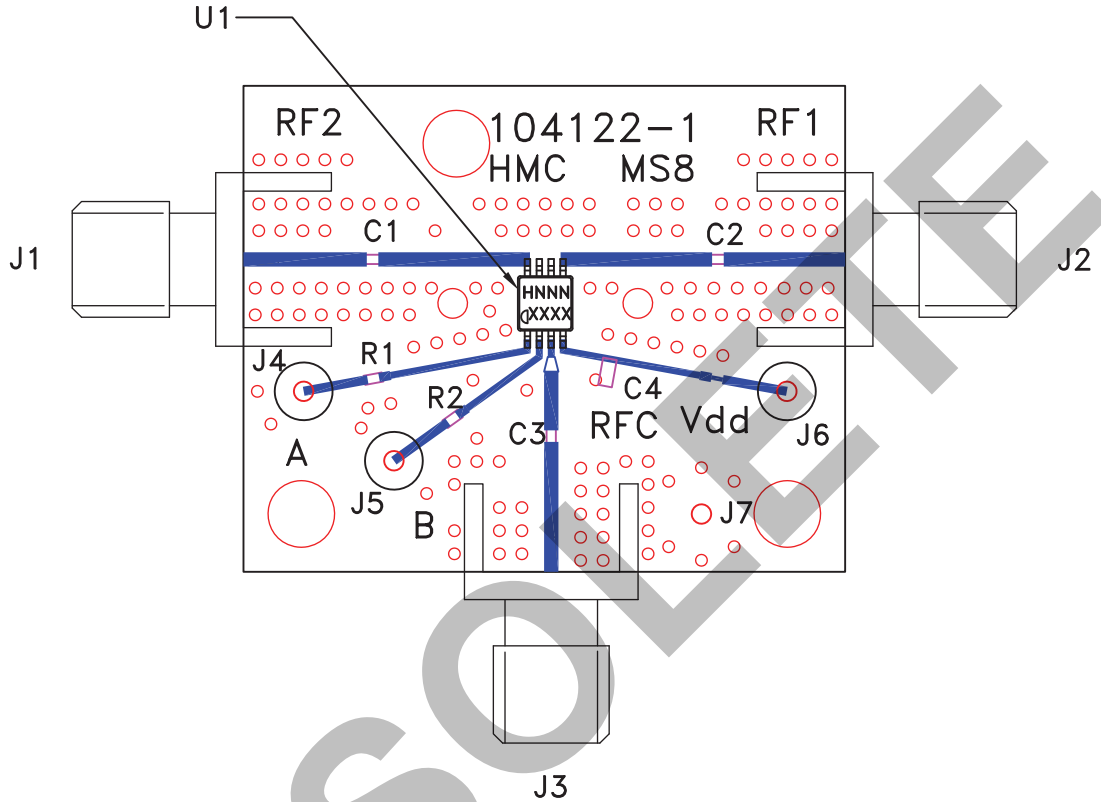

List of Materials for Evaluation PCB 104124 [1]

Item	Description
J1 - J3	PCB Mount SMA RF Connector
J4 - J7	DC Pin
C1 - C3	100 pF Capacitor, 0402 Pkg.
C4	10k pF Capacitor, 0603 Pkg.
R1 - R2	100 Ohm Resistor, 0402 Pkg.
U1	HMC336MS8G / HMC336MS8GE SPDT Switch
PCB [2]	104122 Evaluation PCB 1.05"x1.30"



[1] Reference this number when ordering complete evaluation PCB

[2] Circuit Board Material: Rogers 4350

The circuit board used in the final application should be generated with proper RF circuit design techniques. Signal lines at the RF port should have 50 ohm impedance and the package ground leads and backside ground slug should be connected directly to the ground plane similar to that shown above. The evaluation circuit board shown above is available from Hittite Microwave Corporation upon request.

Looking for pricing, stock, or lifecycle information?

Click below to explore more details on WIN SOURCE:

-  [View HMC336MS8GETR on WIN SOURCE](#)
-  [Analog Devices Inc. Information](#)

Optimize Your Supply Chain with WIN SOURCE Solutions

-  Global Sourcing Solution
-  Obsolete Management
-  Cost Control Management
-  Shortage Management
-  Alternative Solution
-  Excess Inventory Management