



**THE DATASHEET OF  
BGX7101HN/1,118**





# BGX7101

## Transmitter IQ modulator

Rev. 5 — 25 January 2017

Product data sheet

## 1. General description

---

The BGX7101 is, also known as the BTS8001A, a device combines high performance, high linearity I and Q modulation paths for use in radio frequency up-conversion. It supports RF frequency outputs in the range from 400 MHz to 4000 MHz. The BGX7101 IQ modulator is performance independent of the IQ common mode voltage. The modulator provides a typical output power at 1 dB gain compression ( $P_{L(1dB)}$ ) value of 12 dBm and a typical 27 dBm output third-order intercept point ( $IP3_o$ ). Unadjusted sideband suppression and carrier feedthrough are 50 dBc and -45 dBm respectively. A hardware control pin provides a fast power-down/power-up mode functionality which allows significant power saving.

## 2. Features and benefits

---

- 400 MHz to 4000 MHz frequency operating range
- Stable performance across 0.25 V to 3.3 V common-mode voltage input
- Independent low-current power-down hardware control pin
- 12 dBm output -1 dB compression point
- 27 dBm output third-order intercept point (typical)
- Integrated active biasing
- Single 5 V supply
- 100  $\Omega$  differential IQ input impedance
- Matched 50  $\Omega$  single-ended RF output impedance
- ESD protection at all pins

## 3. Applications

---

- Mobile network infrastructure
- Microwave and broadband
- RF and IF applications
- Industrial applications

## 4. Device family

---

The BGX7101 operates in the RF frequency range of 400 MHz to 4000 MHz with modulation bandwidths up to 650 MHz.



## 5. Ordering information

Table 1. Ordering information

Type number	Package		Version
	Name	Description	
BGX7101HN	HVQFN24	plastic thermal enhanced very thin quad flat package; no leads; 24 terminals; body 4 × 4 × 0.85 mm	SOT616-3

## 6. Functional diagram

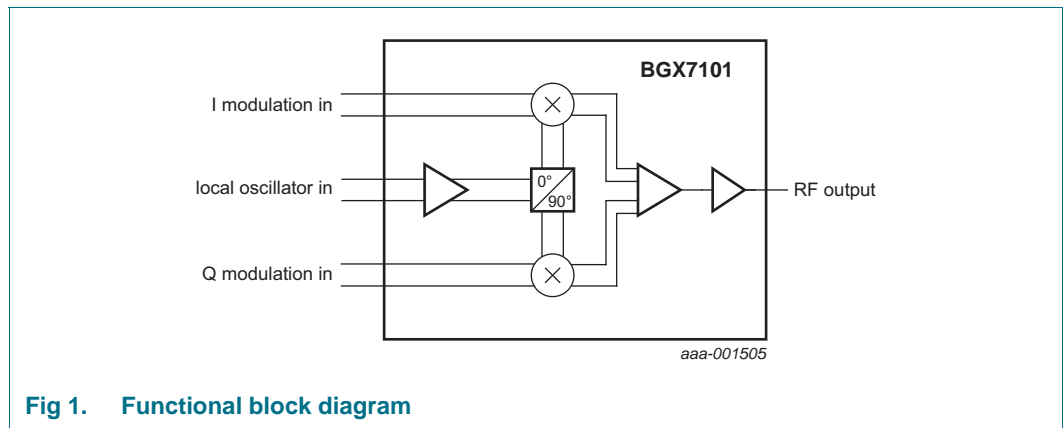

Fig 1. Functional block diagram

Differential I and Q baseband inputs are each fed to an associated upconverter mixer. The Local Oscillator (LO) carrier input is buffered and split into 0 degree and 90 degree signals. The in-phase signal is passed to the I mixer and the 90 degree phase-changed signal is passed to the Q mixer. The outputs of the mixers are summed to produce the resulting RF output signal.

## 7. Pinning information

### 7.1 Pinning

The BGX7101 device pinout is designed to allow easy interfacing when mounted on a Printed-Circuit Board (PCB). When viewing the device from above, the two differential IQ baseband input paths are at the top and bottom. The common LO input is at the left and the RF output at the right. Multiple power and ground pins allow for independent supply domains, improving isolation between blocks. A small package footprint is chosen to reduce bond-wire induced series inductance in the RF ports.

The input and output pin matching is described in [Section 12 “Application information”](#).

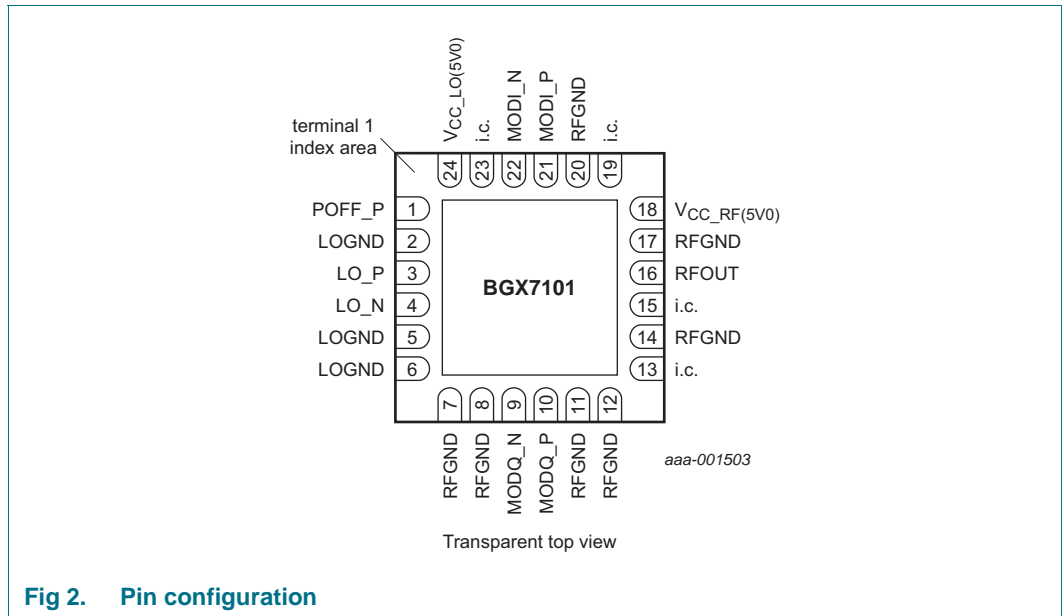

## 7.2 Pin description

**Table 2. Pin description**

Symbol	Pin	Type <sup>[1]</sup>	Description
POFF_P	1	I	active HIGH logic input to power-down modulator
LOGND	2	G	LO ground
LO_P	3	I	LO positive input <sup>[2]</sup>
LO_N	4	I	LO negative input <sup>[2]</sup>
LOGND	5	G	LO ground
LOGND	6	G	LO ground
RFGND	7	G	RF ground
RFGND	8	G	RF ground
MODQ_N	9	I	modulator quadrature negative input
MODQ_P	10	I	modulator quadrature positive input
RFGND	11	G	RF ground
RFGND	12	G	RF ground
i.c.	13	-	internally connected; to be tied to ground
RFGND	14	G	RF ground
i.c.	15	-	internally connected; to be tied to ground
RFOUT	16	O	modulator single-ended RF output <sup>[2]</sup>
RFGND	17	G	RF ground
V <sub>CC_RF(5V0)</sub>	18	P	RF analog power supply 5 V
i.c.	19	-	internally connected; to be tied to ground
RFGND	20	G	RF ground
MODI_P	21	I	modulator in-phase positive input
MODI_N	22	I	modulator in-phase negative input

**Table 2.** Pin description ...continued

Symbol	Pin	Type <sup>[1]</sup>	Description
i.c.	23	-	internally connected; to be tied to ground
V <sub>CC_LO(5V0)</sub>	24	P	LO analog power supply 5 V
Exposed die pad	-	G	exposed die pad; must be connected to RF ground

[1] G = ground; I = input; O = output; P = power.

[2] AC coupling required as shown in [Figure 4 "Typical wideband application diagram"](#).

## 8. Functional description

### 8.1 General

Each IQ baseband input has a 100  $\Omega$  differential input impedance allowing straightforward matching, from the DAC output through the baseband filter. The device allows operation with IQ input common-mode voltages between 0.25 V and 3.3 V allowing direct connection to a broad family of DACs. The LO and RF ports provide broadband 50  $\Omega$  termination to RF source and loads.

The chip can be placed in inactive mode (see [Section 8.2 "Shutdown control"](#)).

### 8.2 Shutdown control

**Table 3.** Shutdown control

Mode	Mode description	Functional description	POFF_P
Idle	modulator fully off; minimal supply current	shutdown enabled	> 1.5 V
Active	modulator active mode	shutdown disabled	< 0.5 V

The modulator can be placed into inactive mode by the voltage level at power-up disable pin (pin 1, POFF\_P). The time required to pass between active and low-current states is less than 1  $\mu$ s.

The shutdown feature of IQ modulator during switching does not induce any unlock of the LO synthesizer in base station application thanks to the low impedance variation of the LO input.

The graph (see [Figure 3](#)) describes the impact on LO impedance variation during the switching time.

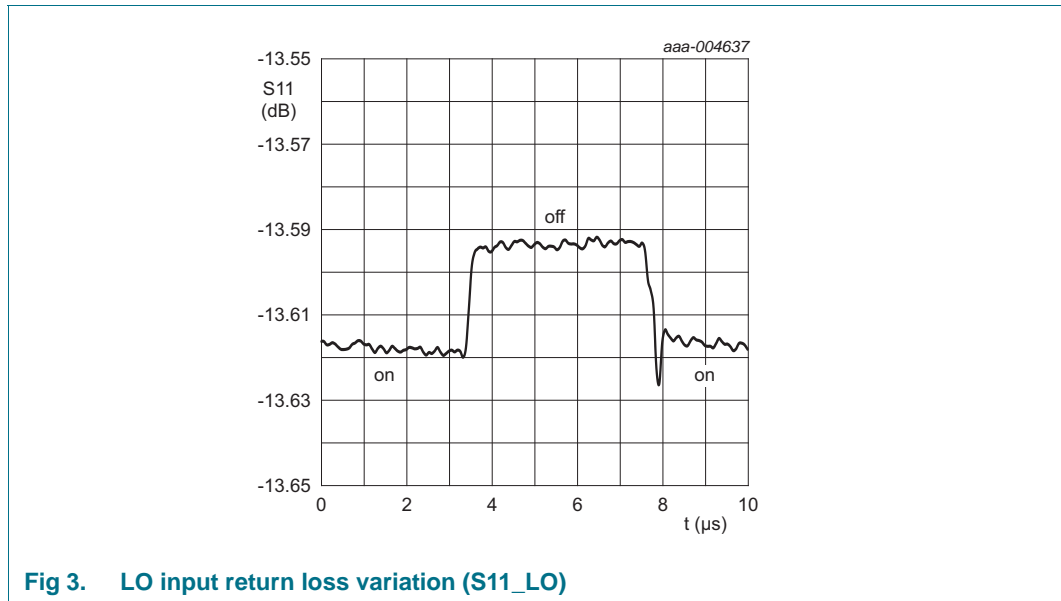

**Fig 3. LO input return loss variation (S11\_LO)**

## 9. Limiting values

**Table 4. Limiting values**

*In accordance with the Absolute Maximum Rating System (IEC 60134).*

Symbol	Parameter	Conditions	Min	Max	Unit
$V_{CC}$	supply voltage		-	5.5	V
$P_{i(lo)}$	local oscillator input power		-	16	dBm
$P_{o(RF)}$	RF output power		-	20	dBm
$T_{mb}$	mounting base temperature		-40	+85	°C
$T_j$	junction temperature		-	+150	°C
$T_{stg}$	storage temperature		-65	+150	°C
$V_{ESD}$	electrostatic discharge voltage	EIA/JESD22-A114 (HBM)	-2500	+2500	V
		EIA/JESD22-C101 (FCDM)	-650	+650	V

**Table 4. Limiting values ...continued**  
*In accordance with the Absolute Maximum Rating System (IEC 60134).*

Symbol	Parameter	Conditions	Min	Max	Unit
<b>Pin POFF_P</b>					
V <sub>i</sub>	input voltage	active HIGH logic input to power-down modulator	-	3.5	V
<b>Pins MODI_N, MODI_P, MODQ_N and MODQ_P</b>					
V <sub>i</sub>	input voltage		0	5	V
V <sub>ID</sub>	differential input voltage	DC	-1	+1	V

## 10. Thermal characteristics

**Table 5. Thermal characteristics**

Symbol	Parameter	Conditions	Typ	Unit
R <sub>th(j-mb)</sub>	thermal resistance from junction to mounting base		10	K/W

## 11. Characteristics

**Table 6. Characteristics**

*Modulation source resistance per pin = 50 Ω; POFF\_P connected to GND (shutdown disabled); V<sub>CC</sub> = 5 V; T<sub>mb</sub> range = -40 °C to +85 °C; P<sub>i(lo)</sub> = 0 dBm; IQ frequency = 5 MHz unless otherwise stated.*

Symbol	Parameter	Conditions	Min	Typ	Max	Unit
V <sub>CC</sub>	supply voltage		4.75	5	5.25	V
I <sub>CC(tot)</sub>	total supply current	modulator in active mode				
		f <sub>lo</sub> = 900 MHz	-	172	-	mA
		f <sub>lo</sub> = 2 GHz	-	180	-	mA
		f <sub>lo</sub> = 2.5 GHz	-	182	-	mA
		f <sub>lo</sub> = 3.5 GHz	-	188	-	mA
		modulator in inactive mode; T <sub>mb</sub> = 25 °C	-	6	-	mA
f <sub>lo</sub>	local oscillator frequency	[1]	400	-	4000	MHz
P <sub>i(lo)</sub>	local oscillator input power	[1]	-9	0	+6	dBm
<b>Pins MODI_x and MODQ_x[2]</b>						
V <sub>i(cm)</sub>	common-mode input voltage		0.25	-	3.3	V
S22_RF	RF output return loss		-	10	-	dB
S11_LO	LO input return loss		-	12	-	dB
<b>MODI and MODQ[3]</b>						
BW <sub>mod</sub>	modulation bandwidth	gain fall off < 1 dB; R <sub>S</sub> = 50 Ω	-	650	-	MHz
R <sub>i(dif)</sub>	differential input resistance		-	100	-	Ω
C <sub>i(dif)</sub>	differential input capacitance		-	1.8	-	pF

[1] Operation outside this range is possible but parameters are not guaranteed.

[2] x = N or P.

[3] MODI = MODI\_P – MODI\_N and MODQ = MODQ\_P – MODQ\_N.

**Table 7. Characteristics at 750 MHz**

Modulation source resistance per pin = 50  $\Omega$ ; POFF\_P connected to GND (shutdown disabled);  $V_{CC} = 5$  V;  
 $T_{mb}$  range = -40 °C to +85 °C;  $P_{i(lo)} = 0$  dBm; IQ frequency = 5 MHz unless otherwise stated.

Symbol	Parameter	Conditions	Min	Typ	Max	Unit
$P_o$	output power	1 V (p-p) differential on MODI and MODQ <sup>[1]</sup>	-	4	-	dBm
$P_{L(1dB)}$	output power at 1 dB gain compression		-	12	-	dBm
$IP3_o$	output third-order intercept point	IQ frequency 1 = 4.5 MHz; IQ frequency 2 = 5.5 MHz; output power per tone = -10 dBm	-	28	-	dBm
$IP2_o$	output second-order intercept point	IQ frequency 1 = 4.5 MHz; IQ frequency 2 = 5.5 MHz; output power per tone = -10 dBm	-	71	-	dBm
$N_{flr(o)}$	output noise floor	no modulation present	-	-159	-	dBm/Hz
		modulation at MODI and MODQ <sup>[1]</sup> ; $P_{o(RF)} = -10$ dBm	-	-158.5	-	dBm/Hz
SBS	sideband suppression	unadjusted	-	63	-	dBc
CF	carrier feedthrough	unadjusted	-	-51	-	dBm
$\alpha_{HD(bb)}$	baseband harmonic distortion level	harmonic distortion at $f_{LO} + 2 \times$ baseband frequency measured with 1 MHz tone at 1 V (p-p) differential	<sup>[2]</sup> -	76	-	dBc
		harmonic distortion at $f_{LO} + 3 \times$ baseband frequency measured with 1 MHz tone at 1 V (p-p) differential	<sup>[2]</sup> -	89	-	dBc

[1] MODI = MODI\_P – MODI\_N and MODQ = MODQ\_P – MODQ\_N.

[2] Measurements done in supradyn mode.

**Table 8. Characteristics at 910 MHz**

Modulation source resistance per pin = 50  $\Omega$ ; POFF\_P connected to GND (shutdown disabled);  $V_{CC} = 5$  V;  
 $T_{mb}$  range = -40 °C to +85 °C;  $P_{i(lo)} = 0$  dBm; IQ frequency = 5 MHz unless otherwise stated.

Symbol	Parameter	Conditions	Min	Typ	Max	Unit
$P_o$	output power	1 V (p-p) differential on MODI and MODQ <sup>[1]</sup>	-	4	-	dBm
$P_{L(1dB)}$	output power at 1 dB gain compression		-	12	-	dBm
$IP3_o$	output third-order intercept point	IQ frequency 1 = 4.5 MHz; IQ frequency 2 = 5.5 MHz; output power per tone = -10 dBm	-	28	-	dBm
$IP2_o$	output second-order intercept point	IQ frequency 1 = 4.5 MHz; IQ frequency 2 = 5.5 MHz; output power per tone = -10 dBm	-	75	-	dBm

**Table 8. Characteristics at 910 MHz ...continued**

Modulation source resistance per pin = 50  $\Omega$ ; POFF\_P connected to GND (shutdown disabled);  $V_{CC} = 5$  V;  
 $T_{mb}$  range =  $-40$  °C to  $+85$  °C;  $P_{i(lo)} = 0$  dBm; IQ frequency = 5 MHz unless otherwise stated.

Symbol	Parameter	Conditions	Min	Typ	Max	Unit
$N_{flr(o)}$	output noise floor	no modulation present	-	-159	-	dBm/Hz
		modulation at MODI and MODQ <sup>[1]</sup> ; $P_{o(RF)} = -10$ dBm	-	-158.5	-	dBm/Hz
SBS	sideband suppression	unadjusted	-	49	-	dBc
CF	carrier feedthrough	unadjusted	-	-57	-	dBm
$\alpha_{HD(bb)}$	baseband harmonic distortion level	harmonic distortion at $f_{LO} + 2 \times$ baseband frequency measured with 1 MHz tone at 1 V (p-p) differential	<sup>[2]</sup> -	77	-	dBc
		harmonic distortion at $f_{LO} + 3 \times$ baseband frequency measured with 1 MHz tone at 1 V (p-p) differential	<sup>[2]</sup> -	92	-	dBc

[1] MODI = MODI\_P – MODI\_N and MODQ = MODQ\_P – MODQ\_N.

[2] Measurements done in supradyn mode.

**Table 9. Characteristics at 1.840 GHz**

Modulation source resistance per pin = 50  $\Omega$ ; POFF\_P connected to GND (shutdown disabled);  $V_{CC} = 5$  V;  
 $T_{mb}$  range =  $-40$  °C to  $+85$  °C;  $P_{i(lo)} = 0$  dBm; IQ frequency = 5 MHz unless otherwise stated.

Symbol	Parameter	Conditions	Min	Typ	Max	Unit
$P_o$	output power	1 V (p-p) differential on MODI and MODQ <sup>[1]</sup>	-	4	-	dBm
$P_{L(1dB)}$	output power at 1 dB gain compression		-	12	-	dBm
$IP3_o$	output third-order intercept point	IQ frequency 1 = 4.5 MHz; IQ frequency 2 = 5.5 MHz; output power per tone = -10 dBm	-	27	-	dBm
$IP2_o$	output second-order intercept point	IQ frequency 1 = 4.5 MHz; IQ frequency 2 = 5.5 MHz; output power per tone = -10 dBm	-	71	-	dBm
$N_{flr(o)}$	output noise floor	no modulation present	-	-158.5	-	dBm/Hz
		modulation at MODI and MODQ <sup>[1]</sup> ; $P_{o(RF)} = -10$ dBm	-	-158	-	dBm/Hz
SBS	sideband suppression	unadjusted	-	55	-	dBc
CF	carrier feedthrough	unadjusted	-	-50	-	dBm
$\alpha_{HD(bb)}$	baseband harmonic distortion level	harmonic distortion at $f_{LO} + 2 \times$ baseband frequency measured with 1 MHz tone at 1 V (p-p) differential	<sup>[2]</sup> -	84	-	dBc
		harmonic distortion at $f_{LO} + 3 \times$ baseband frequency measured with 1 MHz tone at 1 V (p-p) differential	<sup>[2]</sup> -	86	-	dBc

[1]  $MODI = MODI\_P - MODI\_N$  and  $MODQ = MODQ\_P - MODQ\_N$ .

[2] Measurements done in supradyn mode.

**Table 10. Characteristics at 1.960 GHz**

Modulation source resistance per pin = 50  $\Omega$ ;  $POFF\_P$  connected to GND (shutdown disabled);  $V_{CC} = 5$  V;  $T_{mb}$  range =  $-40$  °C to  $+85$  °C;  $P_{i(lo)} = 0$  dBm; IQ frequency = 5 MHz unless otherwise stated.

Symbol	Parameter	Conditions	Min	Typ	Max	Unit	
$P_o$	output power	1 V (p-p) differential on MODI and MODQ[1]	-	4	-	dBm	
$P_{L(1dB)}$	output power at 1 dB gain compression		-	12	-	dBm	
$IP3_o$	output third-order intercept point	IQ frequency 1 = 4.5 MHz; IQ frequency 2 = 5.5 MHz; output power per tone = $-10$ dBm	-	27	-	dBm	
$IP2_o$	output second-order intercept point	IQ frequency 1 = 4.5 MHz; IQ frequency 2 = 5.5 MHz; output power per tone = $-10$ dBm	-	72	-	dBm	
$N_{flr(o)}$	output noise floor	no modulation present	-	$-158.5$	-	dBm/Hz	
		modulation at MODI and MODQ[1]; $P_{o(RF)} = -10$ dBm	-	$-158$	-	dBm/Hz	
SBS	sideband suppression	unadjusted	-	57	-	dBc	
CF	carrier feedthrough	unadjusted	-	$-47$	-	dBm	
$\alpha_{HD(bb)}$	baseband harmonic distortion level	harmonic distortion at $f_{LO} + 2 \times$ baseband frequency measured with 1 MHz tone at 1 V (p-p) differential	[2]	-	72	-	dBc
		harmonic distortion at $f_{LO} + 3 \times$ baseband frequency measured with 1 MHz tone at 1 V (p-p) differential	[2]	-	86	-	dBc

[1]  $MODI = MODI\_P - MODI\_N$  and  $MODQ = MODQ\_P - MODQ\_N$ .

[2] Measurements done in supradyn mode.

**Table 11. Characteristics at 2.140 GHz**

Modulation source resistance per pin = 50  $\Omega$ ;  $POFF\_P$  connected to GND (shutdown disabled);  $V_{CC} = 5$  V;  $T_{mb}$  range =  $-40$  °C to  $+85$  °C;  $P_{i(lo)} = 0$  dBm; IQ frequency = 5 MHz unless otherwise stated.

Symbol	Parameter	Conditions	Min	Typ	Max	Unit
$P_o$	output power	1 V (p-p) differential on MODI and MODQ[1]	-	4	-	dBm
$P_{L(1dB)}$	output power at 1 dB gain compression		-	12	-	dBm
$IP3_o$	output third-order intercept point	IQ frequency 1 = 4.5 MHz; IQ frequency 2 = 5.5 MHz; output power per tone = $-10$ dBm	-	27	-	dBm

**Table 11. Characteristics at 2.140 GHz ...continued**

Modulation source resistance per pin = 50  $\Omega$ ; POFF\_P connected to GND (shutdown disabled);  $V_{CC} = 5$  V;  
 $T_{mb}$  range =  $-40$  °C to  $+85$  °C;  $P_{i(lo)} = 0$  dBm; IQ frequency = 5 MHz unless otherwise stated.

Symbol	Parameter	Conditions	Min	Typ	Max	Unit	
IP2 <sub>o</sub>	output second-order intercept point	IQ frequency 1 = 4.5 MHz; IQ frequency 2 = 5.5 MHz; output power per tone = $-10$ dBm	-	75	-	dBm	
N <sub>flr(o)</sub>	output noise floor	no modulation present	-	$-158.5$	-	dBm/Hz	
		modulation at MODI and MODQ[1]; $P_{o(RF)} = -10$ dBm	-	$-158$	-	dBm/Hz	
SBS	sideband suppression	unadjusted	-	63	-	dBc	
CF	carrier feedthrough	unadjusted	-	$-45$	-	dBm	
$\alpha_{HD(bb)}$	baseband harmonic distortion level	harmonic distortion at $f_{LO} + 2 \times$ baseband frequency measured with 1 MHz tone at 1 V (p-p) differential	[2]	-	68	-	dBc
		harmonic distortion at $f_{LO} + 3 \times$ baseband frequency measured with 1 MHz tone at 1 V (p-p) differential	[2]	-	86	-	dBc

[1] MODI = MODI\_P – MODI\_N and MODQ = MODQ\_P – MODQ\_N.

[2] Measurements done in supradyne mode.

**Table 12. Characteristics at 2.650 GHz**

Modulation source resistance per pin = 50  $\Omega$ ; POFF\_P connected to GND (shutdown disabled);  $V_{CC} = 5$  V;  
 $T_{mb}$  range =  $-40$  °C to  $+85$  °C;  $P_{i(lo)} = 0$  dBm; IQ frequency = 5 MHz unless otherwise stated.

Symbol	Parameter	Conditions	Min	Typ	Max	Unit
P <sub>o</sub>	output power	1 V (p-p) differential on MODI and MODQ[1]	-	4	-	dBm
P <sub>L(1dB)</sub>	output power at 1 dB gain compression		-	12	-	dBm
IP3 <sub>o</sub>	output third-order intercept point	IQ frequency 1 = 4.5 MHz; IQ frequency 2 = 5.5 MHz; output power per tone = $-10$ dBm	-	26	-	dBm
IP2 <sub>o</sub>	output second-order intercept point	IQ frequency 1 = 4.5 MHz; IQ frequency 2 = 5.5 MHz; output power per tone = $-10$ dBm	-	65	-	dBm
N <sub>flr(o)</sub>	output noise floor	no modulation present	-	$-158.5$	-	dBm/Hz
		modulation at MODI and MODQ[1]; $P_{o(RF)} = -10$ dBm	-	$-158$	-	dBm/Hz
SBS	sideband suppression	unadjusted	-	50	-	dBc

**Table 12. Characteristics at 2.650 GHz ...continued**

Modulation source resistance per pin = 50  $\Omega$ ; POFF\_P connected to GND (shutdown disabled);  $V_{CC} = 5$  V;  $T_{mb}$  range =  $-40$  °C to  $+85$  °C;  $P_{i(lo)} = 0$  dBm; IQ frequency = 5 MHz unless otherwise stated.

Symbol	Parameter	Conditions	Min	Typ	Max	Unit	
CF	carrier feedthrough	unadjusted	-	-45	-	dBm	
$\alpha_{HD(bb)}$	baseband harmonic distortion level	harmonic distortion at $f_{LO} + 2 \times$ baseband frequency measured with 1 MHz tone at 1 V (p-p) differential	[2]	-	65	-	dBc
		harmonic distortion at $f_{LO} + 3 \times$ baseband frequency measured with 1 MHz tone at 1 V (p-p) differential	[2]	-	88	-	dBc

[1]  $MODI = MODI\_P - MODI\_N$  and  $MODQ = MODQ\_P - MODQ\_N$ .

[2] Measurements done in supradyn mode.

**Table 13. Characteristics at 3.650 GHz**

Modulation source resistance per pin = 50  $\Omega$ ; POFF\_P connected to GND (shutdown disabled);  $V_{CC} = 5$  V;  $T_{mb}$  range =  $-40$  °C to  $+85$  °C;  $P_{i(lo)} = 0$  dBm; IQ frequency = 5 MHz unless otherwise stated.

Symbol	Parameter	Conditions	Min	Typ	Max	Unit	
$P_o$	output power	1 V (p-p) differential on MODI and MODQ[1]	-	4	-	dBm	
$P_{L(1dB)}$	output power at 1 dB gain compression		-	12	-	dBm	
$IP3_o$	output third-order intercept point	IQ frequency 1 = 4.5 MHz; IQ frequency 2 = 5.5 MHz; output power per tone = $-10$ dBm	-	25	-	dBm	
$IP2_o$	output second-order intercept point	IQ frequency 1 = 4.5 MHz; IQ frequency 2 = 5.5 MHz; output power per tone = $-10$ dBm	-	64	-	dBm	
$N_{flr(o)}$	output noise floor	no modulation present	-	-158	-	dBm/Hz	
		modulation at MODI and MODQ[1]; $P_{o(RF)} = -10$ dBm	-	-158	-	dBm/Hz	
SBS	sideband suppression	unadjusted	-	57	-	dBc	
CF	carrier feedthrough	unadjusted	-	-42	-	dBm	
$\alpha_{HD(bb)}$	baseband harmonic distortion level	harmonic distortion at $f_{LO} + 2 \times$ baseband frequency measured with 1 MHz tone at 1 V (p-p) differential	[2]	-	64	-	dBc
		harmonic distortion at $f_{LO} + 3 \times$ baseband frequency measured with 1 MHz tone at 1 V (p-p) differential	[2]	-	80	-	dBc

[1]  $MODI = MODI\_P - MODI\_N$  and  $MODQ = MODQ\_P - MODQ\_N$ .

[2] Measurements done in supradyn mode.

## 12. Application information

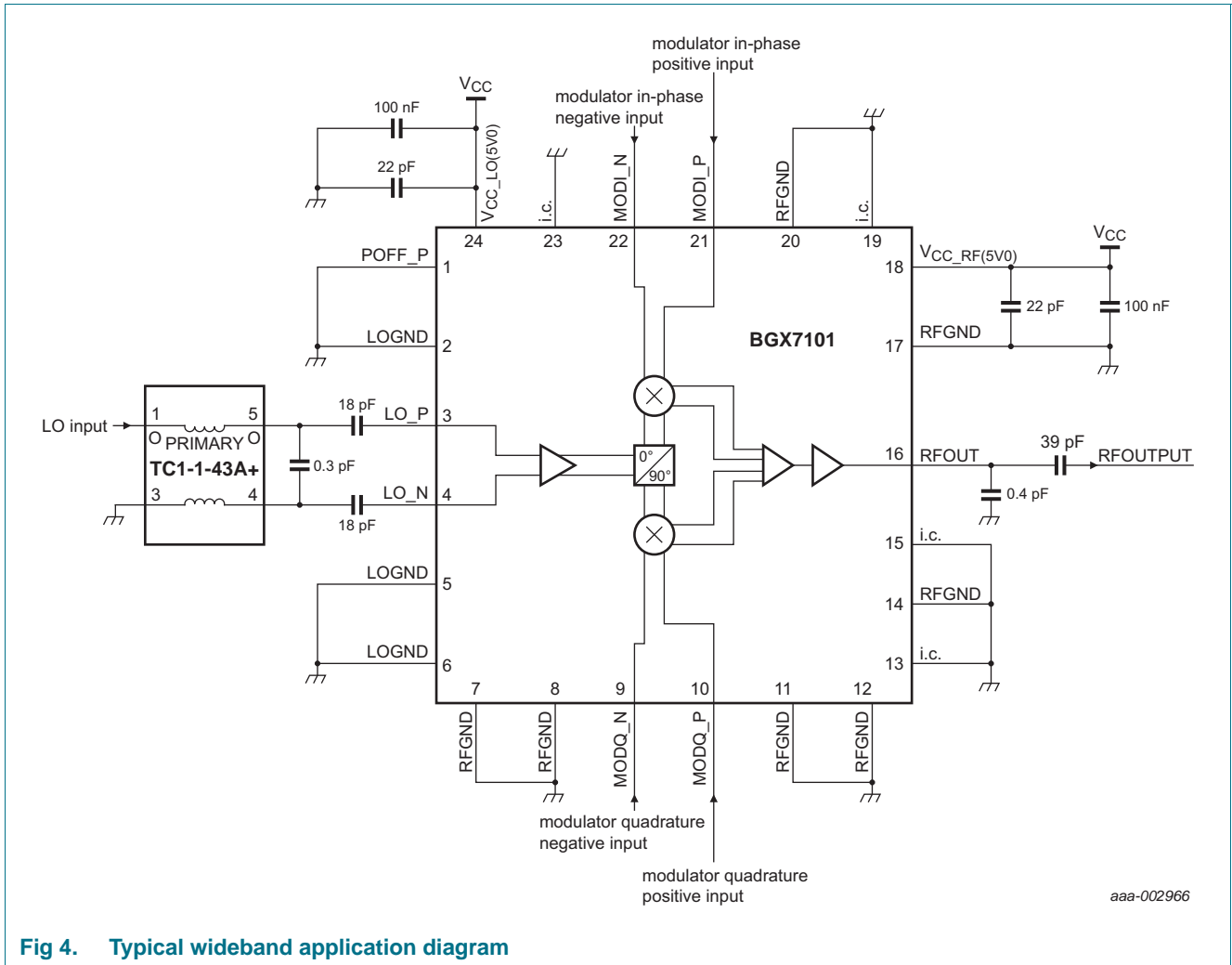

Figure 4 shows a typical wideband (from 0.4 GHz to 4 GHz) application circuit. Refer to the application note for narrowband optimum component values.

### 12.1 External DAC interfacing

Nominal DAC single-ended output currents are between 0 mA to 20 mA. When driving into 25 Ω impedance, this creates 250 mV peak-single signal (1 V (p-p) differential). Half of the impedance is placed at the DAC outputs as 50 Ω load resistors, the other half is provided by the modulator itself. In this way, the differential filter can be properly terminated by 100 Ω at both ends.

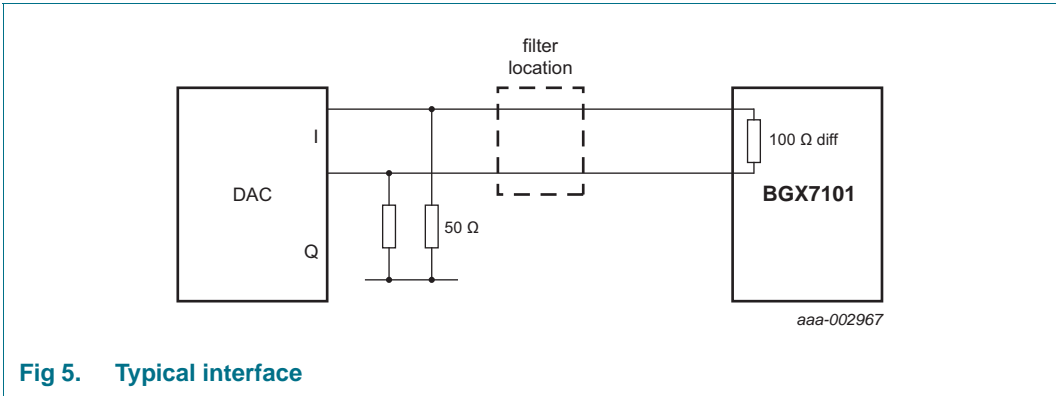

Fig 5. Typical interface

### 12.2 RF

Good RF port matching typically requires some reactive components to tune-out residual inductance or capacitance. As the LO inputs and RF output are internally DC biased, both pins need a series AC-coupling capacitor.

### 13. Test information

Parameters for the following drawings:  $V_{CC} = 5\text{ V}$ ;  $T_{mb} = 25\text{ }^{\circ}\text{C}$ ;  $P_{i(lo)} = 0\text{ dBm}$ ; IQ frequency = 5 MHz; IQ amplitude = 0.42 V (p-p) differential sine wave;  $V_{i(cm)} = 0.5\text{ V}$ ; broadband output match; unless otherwise specified.

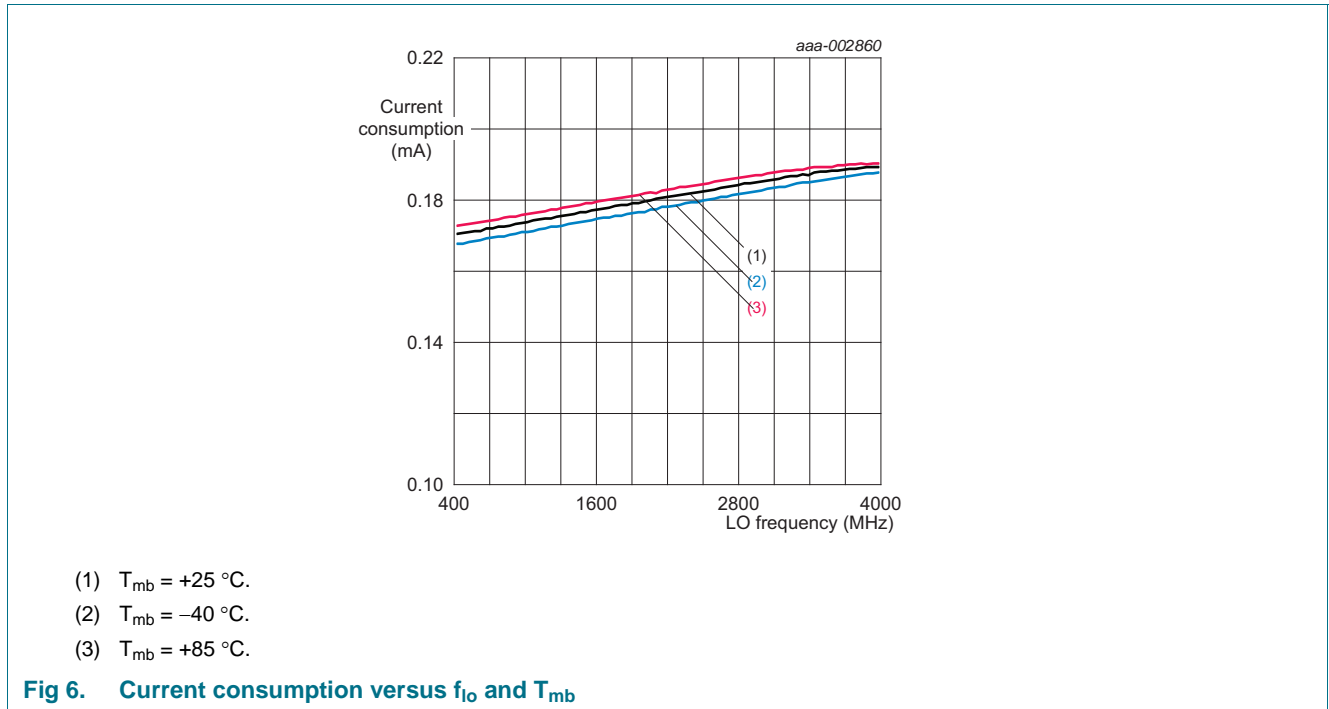

Parameters for the five following drawings:  $V_{CC} = 5\text{ V}$ ;  $T_{mb} = 25\text{ }^\circ\text{C}$ ;  $P_{i(lo)} = 0\text{ dBm}$ ; IQ frequency = 5 MHz; IQ amplitude = 0.42 V (p-p) differential sine wave;  $V_{i(cm)} = 0.5\text{ V}$ ; broadband output match; unless otherwise specified.

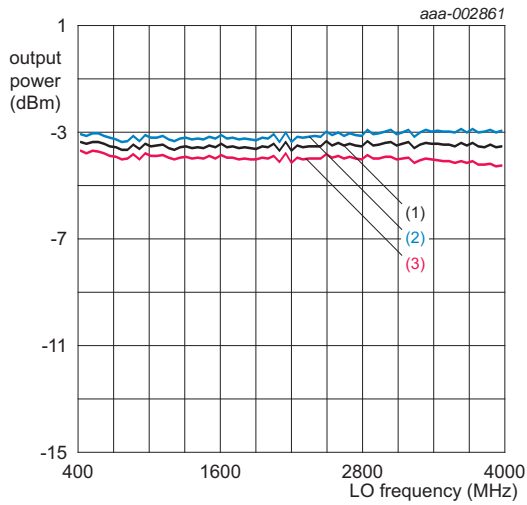

- (1)  $T_{mb} = +25\text{ }^\circ\text{C}$ .
- (2)  $T_{mb} = -40\text{ }^\circ\text{C}$ .
- (3)  $T_{mb} = +85\text{ }^\circ\text{C}$ .

Fig 7.  $P_o$  versus  $f_{lo}$  and  $T_{mb}$

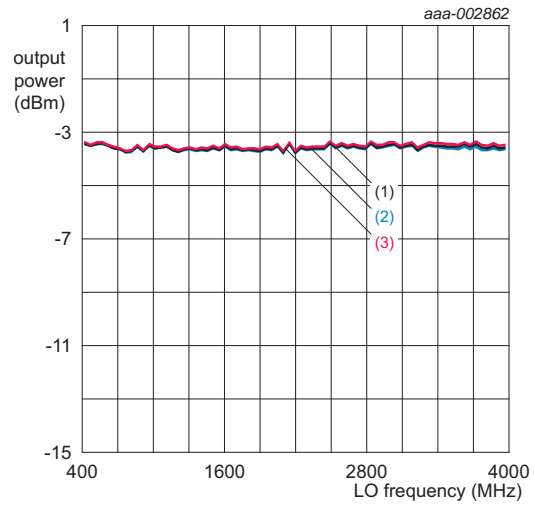

- (1)  $V_{CC} = 5\text{ V}$ .
- (2)  $V_{CC} = 4.75\text{ V}$ .
- (3)  $V_{CC} = 5.25\text{ V}$ .

Fig 8.  $P_o$  versus  $f_{lo}$  and  $V_{CC}$

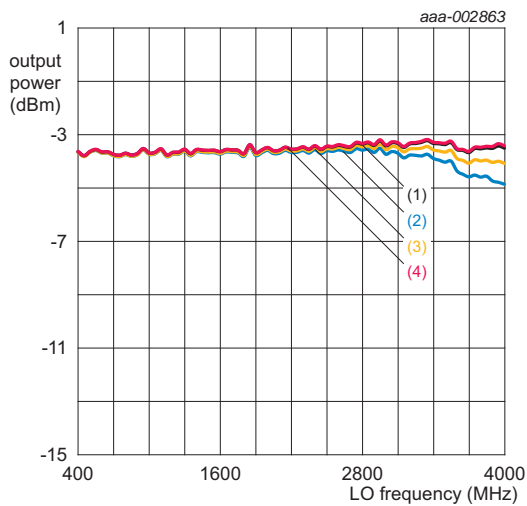

- (1)  $P_{i(lo)} = 0\text{ dBm}$ .
- (2)  $P_{i(lo)} = -9\text{ dBm}$ .
- (3)  $P_{i(lo)} = -6\text{ dBm}$ .
- (4)  $P_{i(lo)} = +6\text{ dBm}$ .

Fig 9.  $P_o$  versus  $f_{lo}$  and  $P_{i(lo)}$

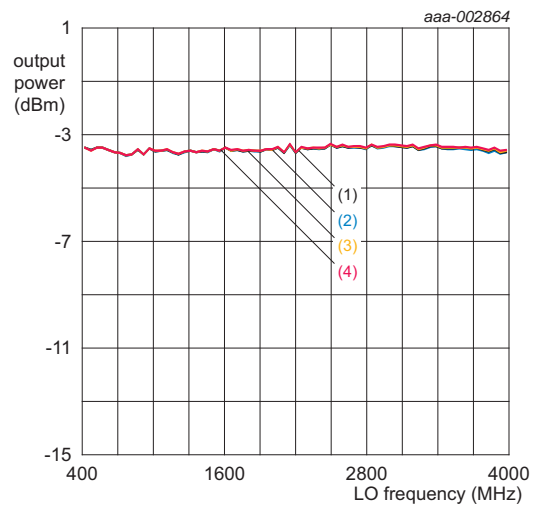

- (1)  $V_{i(cm)} = 0.5\text{ V}$ .
- (2)  $V_{i(cm)} = 0.25\text{ V}$ .
- (3)  $V_{i(cm)} = 1.5\text{ V}$ .
- (4)  $V_{i(cm)} = 2.5\text{ V}$ .

Fig 10.  $P_o$  versus  $f_{lo}$  and  $V_{i(cm)}$

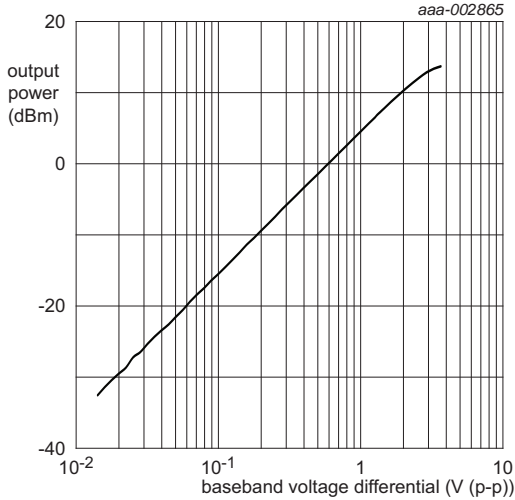

(1)  $f_{io} = 2140$  MHz.

Fig 11.  $P_o$  versus baseband voltage at 2140 MHz

Parameters for the four following drawings:  $V_{CC} = 5\text{ V}$ ;  $T_{mb} = 25\text{ }^\circ\text{C}$ ;  $P_{i(lo)} = 0\text{ dBm}$ ; IQ frequency = 5 MHz; IQ amplitude = 0.42 V (p-p) differential sine wave;  $V_{i(cm)} = 0.5\text{ V}$ ; broadband output match; unless otherwise specified.

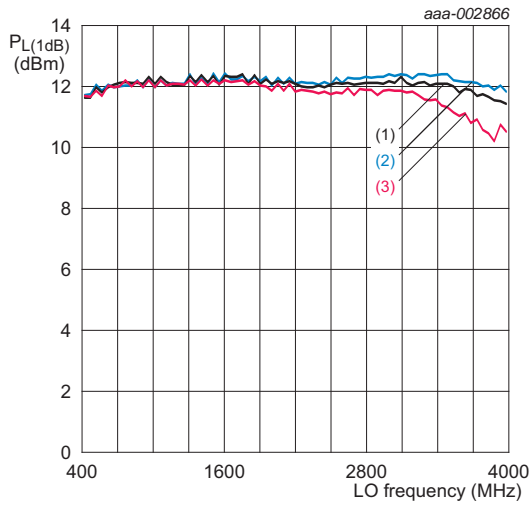

- (1)  $T_{mb} = +25\text{ }^\circ\text{C}$ .
- (2)  $T_{mb} = -40\text{ }^\circ\text{C}$ .
- (3)  $T_{mb} = +85\text{ }^\circ\text{C}$ .

Fig 12.  $P_L(1dB)$  versus  $f_{lo}$  and  $T_{mb}$

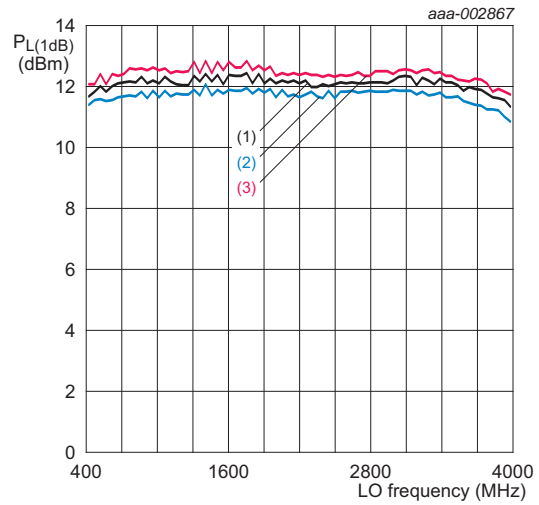

- (1)  $V_{CC} = 5\text{ V}$ .
- (2)  $V_{CC} = 4.75\text{ V}$ .
- (3)  $V_{CC} = 5.25\text{ V}$ .

Fig 13.  $P_L(1dB)$  versus  $f_{lo}$  and  $V_{CC}$

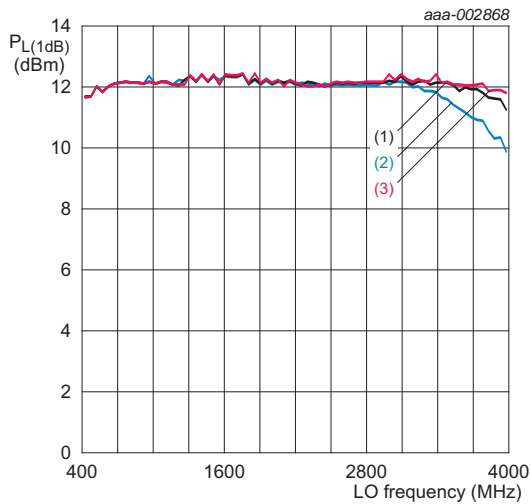

- (1)  $P_{i(lo)} = 0\text{ dBm}$ .
- (2)  $P_{i(lo)} = -3\text{ dBm}$ .
- (3)  $P_{i(lo)} = +3\text{ dBm}$ .

Fig 14.  $P_L(1dB)$  versus  $f_{lo}$  and  $P_{i(lo)}$

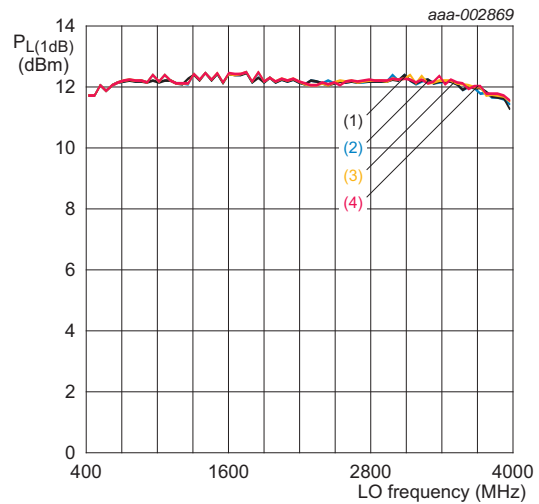

- (1)  $V_{i(cm)} = 0.5\text{ V}$ .
- (2)  $V_{i(cm)} = 0.25\text{ V}$ .
- (3)  $V_{i(cm)} = 1.5\text{ V}$ .
- (4)  $V_{i(cm)} = 2.5\text{ V}$ .

Fig 15.  $P_L(1dB)$  versus  $f_{lo}$  and  $V_{i(cm)}$

Parameters for the four following drawings:  $V_{CC} = 5\text{ V}$ ;  $T_{mb} = 25\text{ }^\circ\text{C}$ ;  $P_{i(lo)} = 0\text{ dBm}$ ; two tones; tone 1: IQ frequency = 4.5 MHz and tone 2: IQ frequency = 5.5 MHz;  $P_o$  per tone =  $-10\text{ dBm}$ ;  $V_{i(cm)} = 0.5\text{ V}$ ; broadband output match; unless otherwise specified.

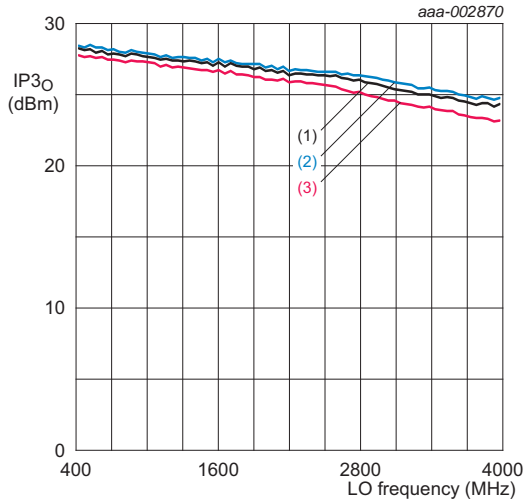

- (1)  $T_{mb} = +25\text{ }^\circ\text{C}$ .
- (2)  $T_{mb} = -40\text{ }^\circ\text{C}$ .
- (3)  $T_{mb} = +85\text{ }^\circ\text{C}$ .

Fig 16.  $IP3_o$  versus  $f_{lo}$  and  $T_{mb}$

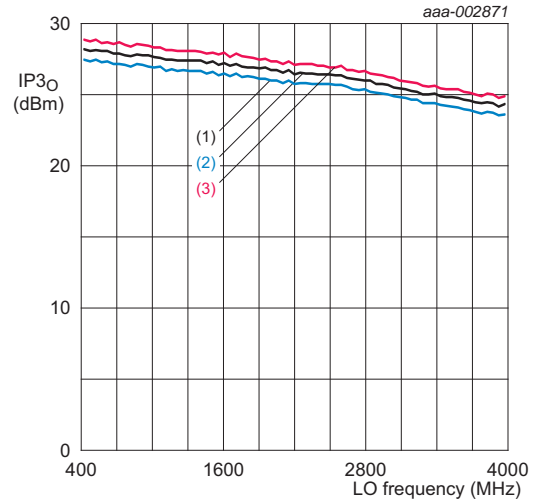

- (1)  $V_{CC} = 5\text{ V}$ .
- (2)  $V_{CC} = 4.75\text{ V}$ .
- (3)  $V_{CC} = 5.25\text{ V}$ .

Fig 17.  $IP3_o$  versus  $f_{lo}$  and  $V_{CC}$

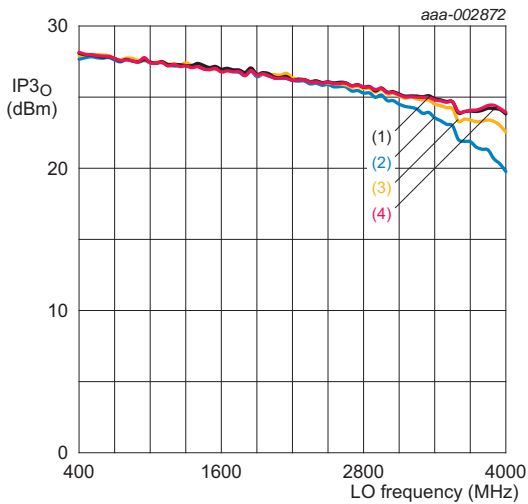

- (1)  $P_{i(lo)} = 0\text{ dBm}$ .
- (2)  $P_{i(lo)} = -9\text{ dBm}$ .
- (3)  $P_{i(lo)} = -6\text{ dBm}$ .
- (4)  $P_{i(lo)} = +6\text{ dBm}$ .

Fig 18.  $IP3_o$  versus  $f_{lo}$  and  $P_{i(lo)}$

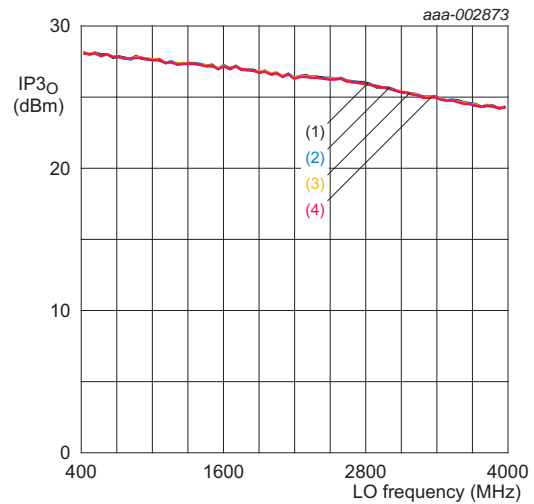

- (1)  $V_{i(cm)} = 0.5\text{ V}$ .
- (2)  $V_{i(cm)} = 0.25\text{ V}$ .
- (3)  $V_{i(cm)} = 1.5\text{ V}$ .
- (4)  $V_{i(cm)} = 2.5\text{ V}$ .

Fig 19.  $IP3_o$  versus  $f_{lo}$  and  $V_{i(cm)}$

Parameters for the four following drawings:  $V_{CC} = 5\text{ V}$ ;  $T_{mb} = 25\text{ }^\circ\text{C}$ ;  $P_{i(lo)} = 0\text{ dBm}$ ; two tones; tone 1: IQ frequency = 4.5 MHz and tone 2: IQ frequency = 5.5 MHz;  $P_o$  per tone =  $-10\text{ dBm}$ ;  $V_{i(cm)} = 0.5\text{ V}$ ; broadband output match; unless otherwise specified.

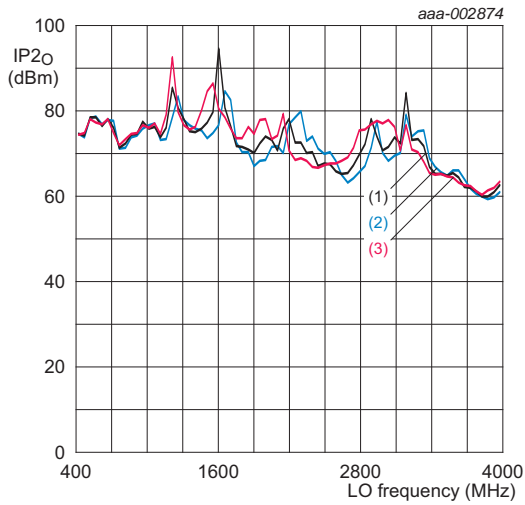

- (1)  $T_{mb} = +25\text{ }^\circ\text{C}$ .
- (2)  $T_{mb} = -40\text{ }^\circ\text{C}$ .
- (3)  $T_{mb} = +85\text{ }^\circ\text{C}$ .

Fig 20.  $IP2_o$  versus  $f_{lo}$  and  $T_{mb}$

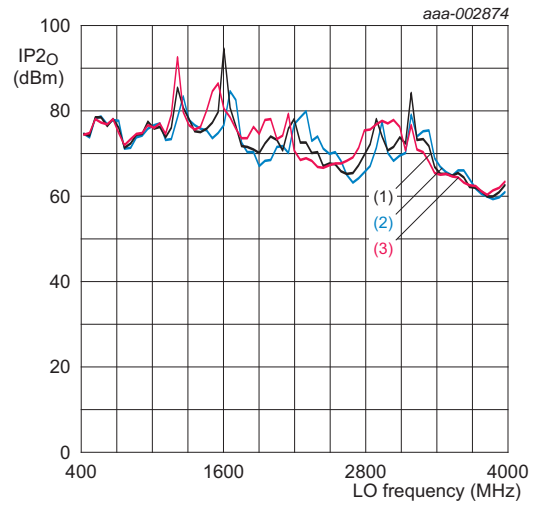

- (1)  $V_{CC} = 5\text{ V}$ .
- (2)  $V_{CC} = 4.75\text{ V}$ .
- (3)  $V_{CC} = 5.25\text{ V}$ .

Fig 21.  $IP2_o$  versus  $f_{lo}$  and  $V_{CC}$

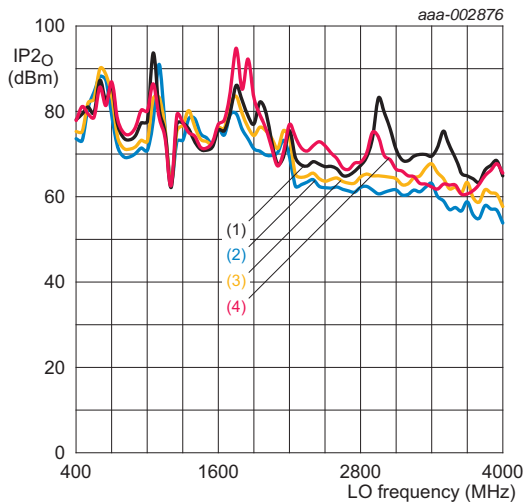

- (1)  $P_{i(lo)} = 0\text{ dBm}$ .
- (2)  $P_{i(lo)} = -9\text{ dBm}$ .
- (3)  $P_{i(lo)} = -6\text{ dBm}$ .
- (4)  $P_{i(lo)} = +6\text{ dBm}$ .

Fig 22.  $IP2_o$  versus  $f_{lo}$  and  $P_{i(lo)}$

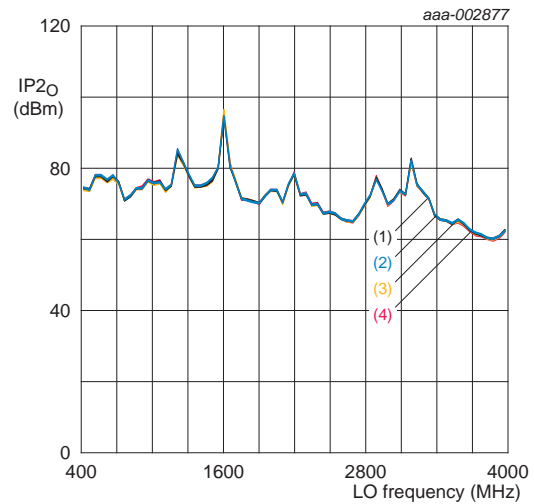

- (1)  $V_{i(cm)} = 0.5\text{ V}$ .
- (2)  $V_{i(cm)} = 0.25\text{ V}$ .
- (3)  $V_{i(cm)} = 1.5\text{ V}$ .
- (4)  $V_{i(cm)} = 2.5\text{ V}$ .

Fig 23.  $IP2_o$  versus  $f_{lo}$  and  $V_{i(cm)}$

Parameters for the five following drawings:  $V_{CC} = 5\text{ V}$ ;  $T_{mb} = 25\text{ }^\circ\text{C}$ ;  $P_{i(lo)} = 0\text{ dBm}$ ; IQ frequency = 5 MHz; IQ amplitude = 0.42 V (p-p) differential sine wave;  $V_{i(cm)} = 0.5\text{ V}$ ; broadband output match; unless otherwise specified.

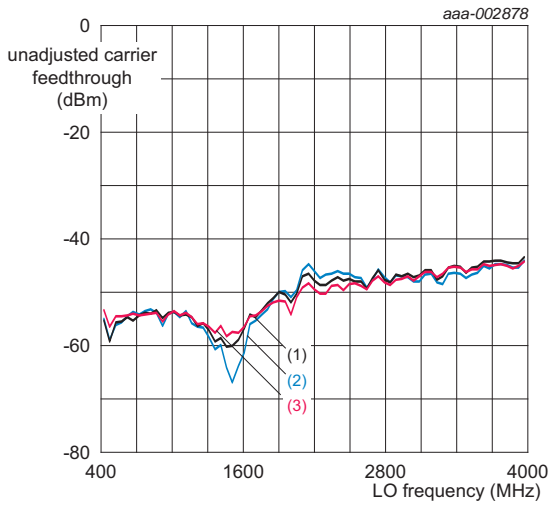

- (1)  $T_{mb} = +25\text{ }^\circ\text{C}$ .
- (2)  $T_{mb} = -40\text{ }^\circ\text{C}$ .
- (3)  $T_{mb} = +85\text{ }^\circ\text{C}$ .

Fig 24. Unadjusted CF versus  $f_{lo}$  and  $T_{mb}$

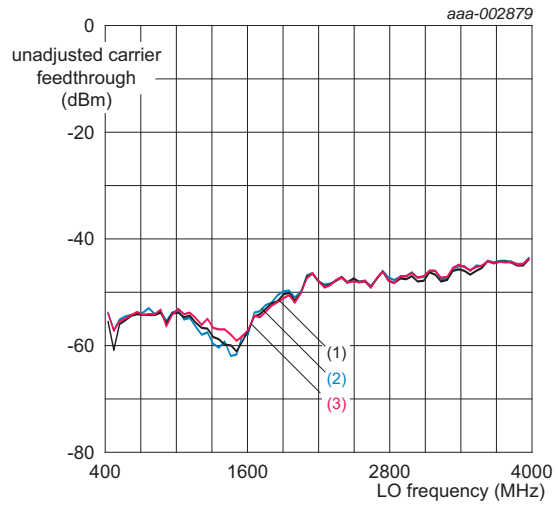

- (1)  $V_{CC} = 5\text{ V}$ .
- (2)  $V_{CC} = 4.75\text{ V}$ .
- (3)  $V_{CC} = 5.25\text{ V}$ .

Fig 25. Unadjusted CF versus  $f_{lo}$  and  $V_{CC}$

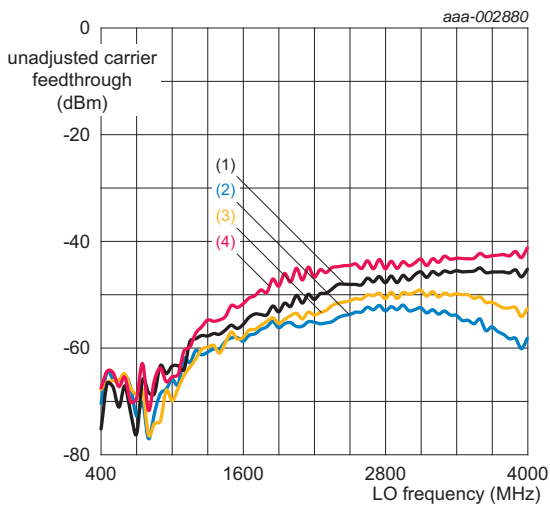

- (1)  $P_{i(lo)} = 0\text{ dBm}$ .
- (2)  $P_{i(lo)} = -9\text{ dBm}$ .
- (3)  $P_{i(lo)} = -6\text{ dBm}$ .
- (4)  $P_{i(lo)} = +6\text{ dBm}$ .

Fig 26. Unadjusted CF versus  $f_{lo}$  and  $P_{i(lo)}$

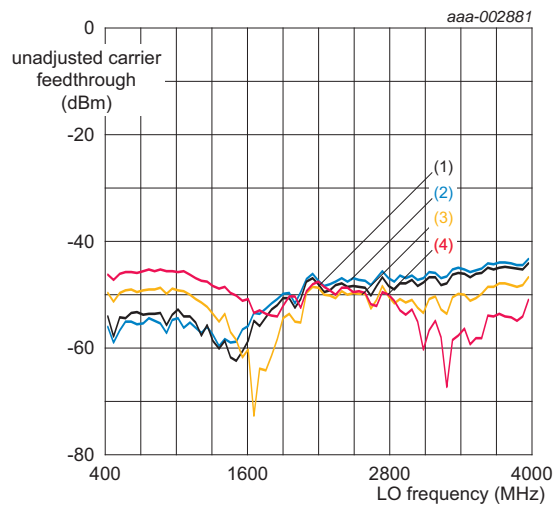

- (1)  $V_{i(cm)} = 0.5\text{ V}$ .
- (2)  $V_{i(cm)} = 0.25\text{ V}$ .
- (3)  $V_{i(cm)} = 1.5\text{ V}$ .
- (4)  $V_{i(cm)} = 2.5\text{ V}$ .

Fig 27. Unadjusted CF versus  $f_{lo}$  and  $V_{i(cm)}$

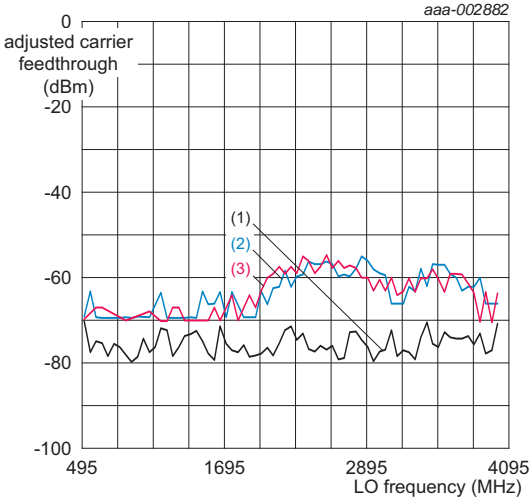

- (1)  $T_{mb} = +25\text{ }^{\circ}\text{C}$ .
- (2)  $T_{mb} = -40\text{ }^{\circ}\text{C}$ .
- (3)  $T_{mb} = +85\text{ }^{\circ}\text{C}$ .

Fig 28. Adjusted CF versus  $f_{lo}$  and  $T_{mb}$  after nulling at 25 °C

Parameters for the five following drawings:  $V_{CC} = 5\text{ V}$ ;  $T_{mb} = 25\text{ }^\circ\text{C}$ ;  $P_{i(lo)} = 0\text{ dBm}$ ; IQ frequency = 5 MHz; IQ amplitude = 0.42 V (p-p) differential sine wave;  $V_{i(cm)} = 0.5\text{ V}$ ; broadband output match; unless otherwise specified.

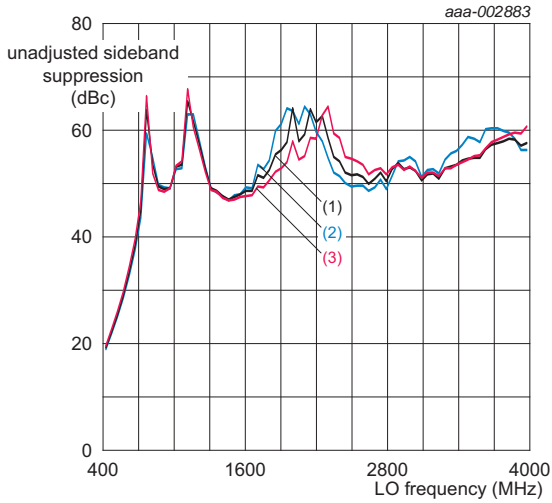

- (1)  $T_{mb} = +25\text{ }^\circ\text{C}$ .
- (2)  $T_{mb} = -40\text{ }^\circ\text{C}$ .
- (3)  $T_{mb} = +85\text{ }^\circ\text{C}$ .

Fig 29. Unadjusted SBS versus  $f_{lo}$  and  $T_{mb}$

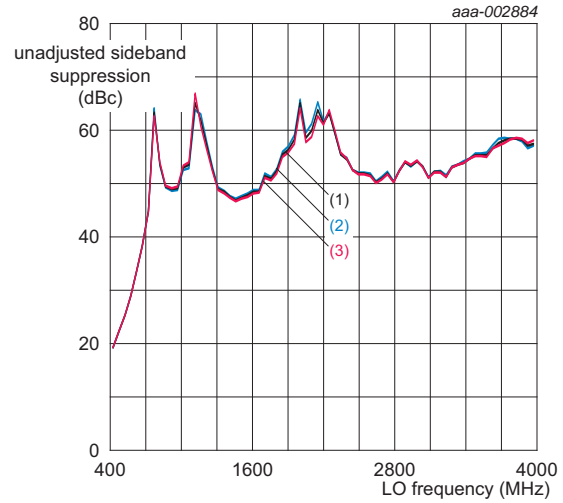

- (1)  $V_{CC} = 5\text{ V}$ .
- (2)  $V_{CC} = 4.75\text{ V}$ .
- (3)  $V_{CC} = 5.25\text{ V}$ .

Fig 30. Unadjusted SBS versus  $f_{lo}$  and  $V_{CC}$

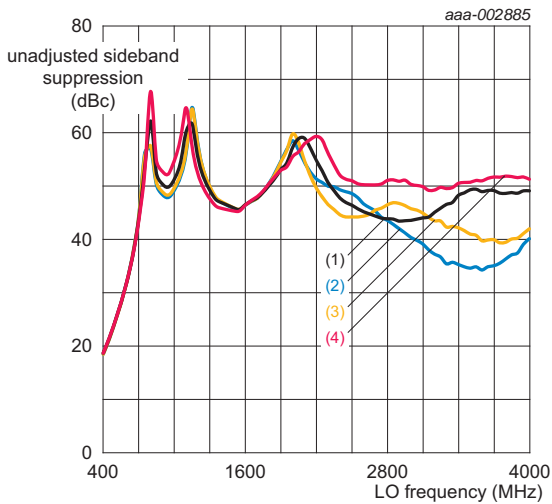

- (1)  $P_{i(lo)} = 0\text{ dBm}$ .
- (2)  $P_{i(lo)} = -9\text{ dBm}$ .
- (3)  $P_{i(lo)} = -6\text{ dBm}$ .
- (4)  $P_{i(lo)} = +6\text{ dBm}$ .

Fig 31. Unadjusted SBS versus  $f_{lo}$  and  $P_{i(lo)}$

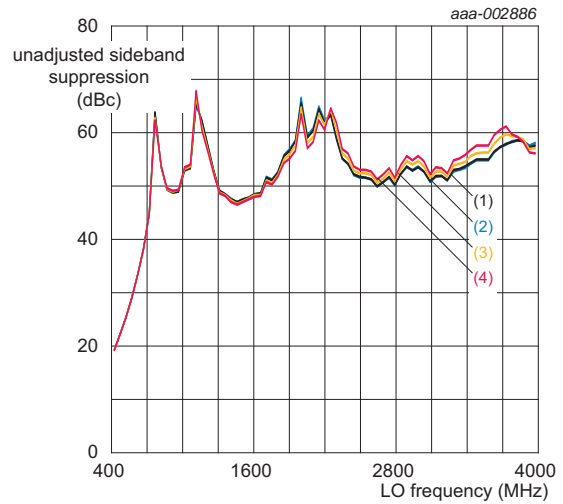

- (1)  $V_{i(cm)} = 0.5\text{ V}$ .
- (2)  $V_{i(cm)} = 0.25\text{ V}$ .
- (3)  $V_{i(cm)} = 1.5\text{ V}$ .
- (4)  $V_{i(cm)} = 2.5\text{ V}$ .

Fig 32. Unadjusted SBS versus  $f_{lo}$  and  $V_{i(cm)}$

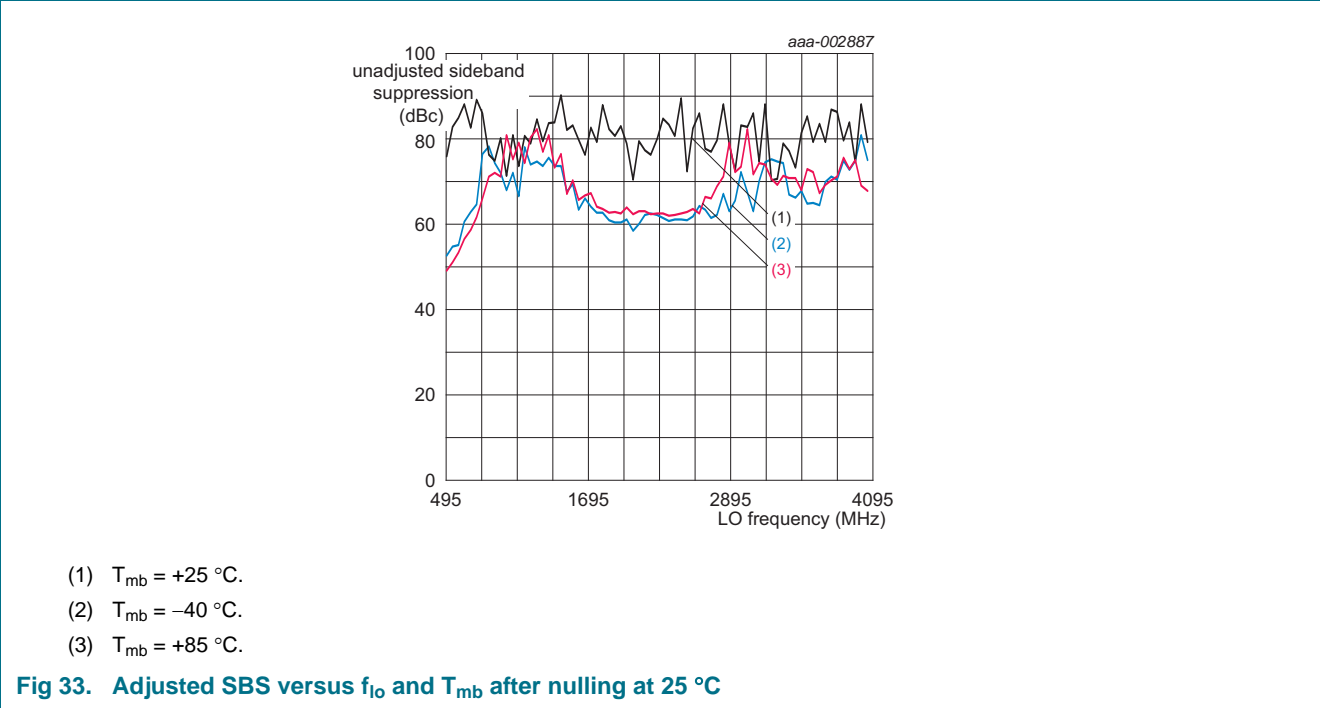

Parameters for the six following drawings:  $V_{CC} = 5\text{ V}$ ;  $T_{mb} = 25\text{ }^{\circ}\text{C}$ ; LO = 0 dBm; IQ frequency = 5 MHz; IQ amplitude = 0.25 V (p-p) single-ended sine wave;  $V_{i(cm)} = 0.5\text{ V}$ ; broadband output match; unless otherwise specified.

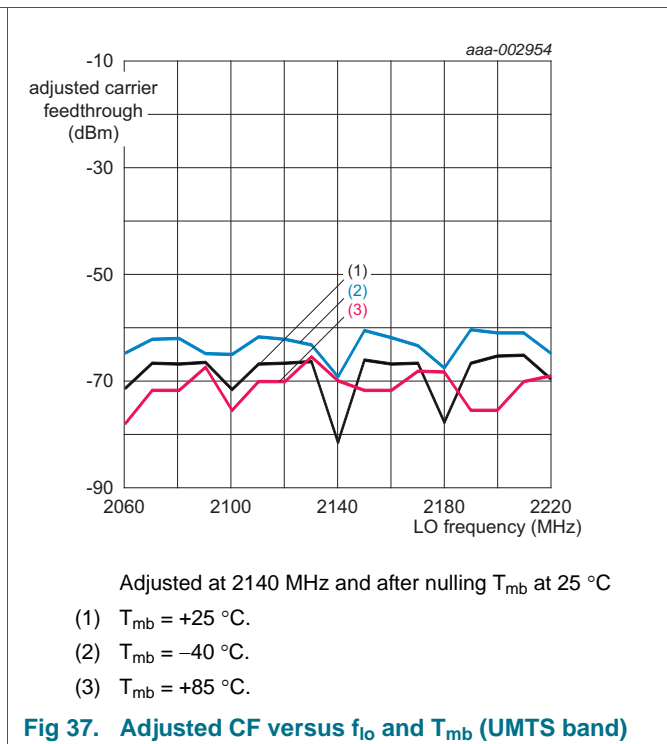
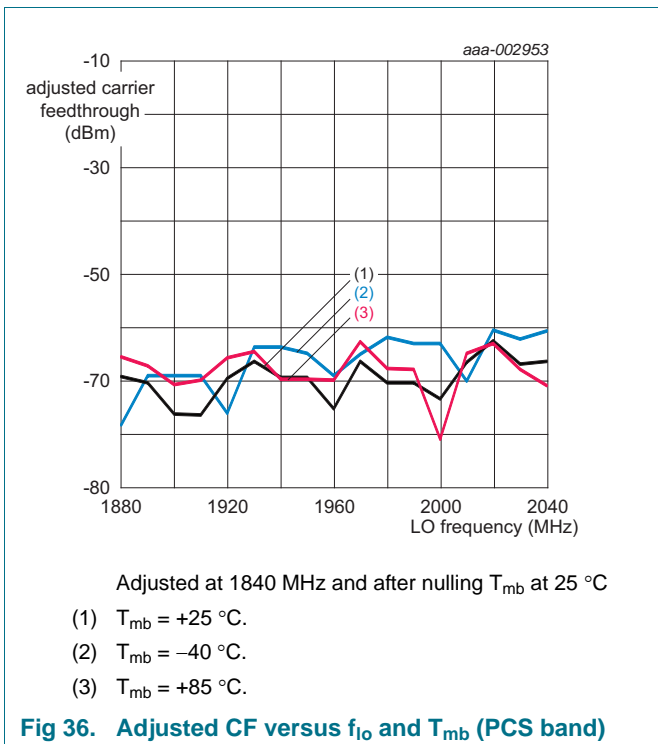
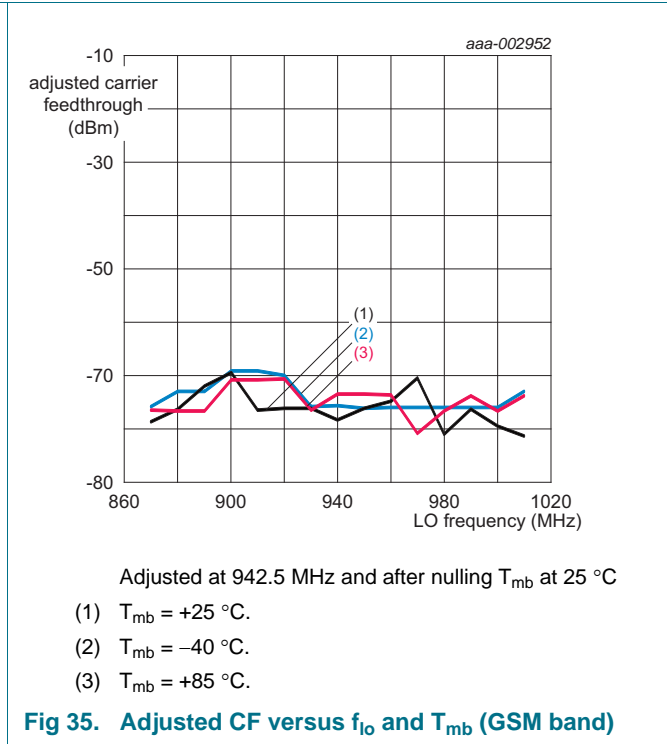
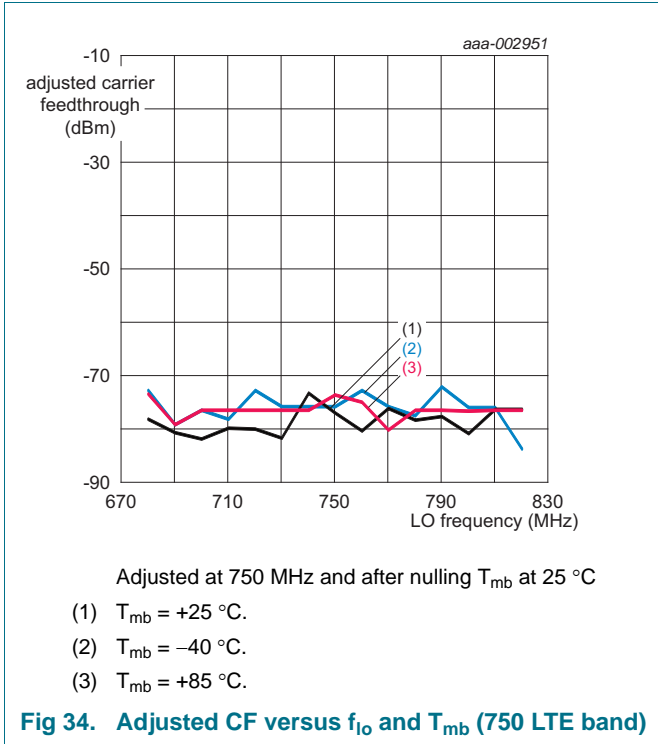

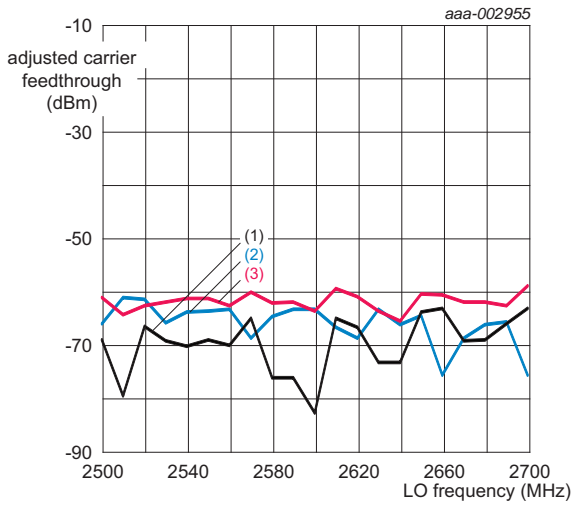

Adjusted at 2600 MHz and after nulling  $T_{mb}$  at 25 °C

- (1)  $T_{mb} = +25$  °C.
- (2)  $T_{mb} = -40$  °C.
- (3)  $T_{mb} = +85$  °C.

**Fig 38. Adjusted CF versus  $f_{lo}$  and  $T_{mb}$  (2.6 GHz LTE band)**

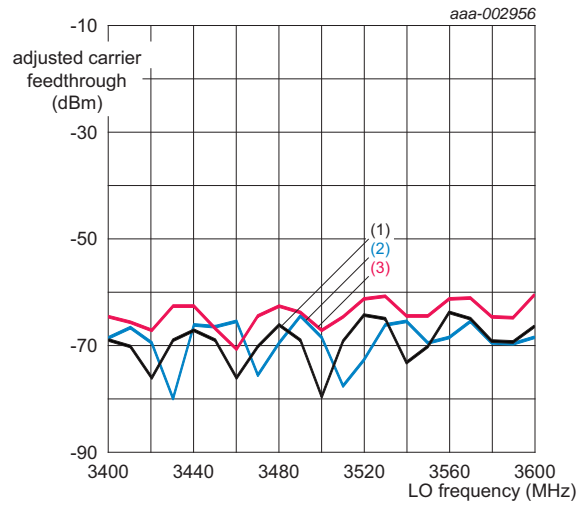

Adjusted at 3500 MHz and after nulling  $T_{mb}$  at 25 °C

- (1)  $T_{mb} = +25$  °C.
- (2)  $T_{mb} = -40$  °C.
- (3)  $T_{mb} = +85$  °C.

**Fig 39. Adjusted CF versus  $f_{lo}$  and  $T_{mb}$  (Wi MAX/LTE band)**

Parameters for the six following drawings:  $V_{CC} = 5\text{ V}$ ;  $T_{mb} = 25\text{ }^{\circ}\text{C}$ ;  $LO = 0\text{ dBm}$ ; IQ frequency = 5 MHz; IQ amplitude = 0.25 V (p-p) single-ended sine wave;  $V_{i(cm)} = 0.5\text{ V}$ ; broadband output match; unless otherwise specified.

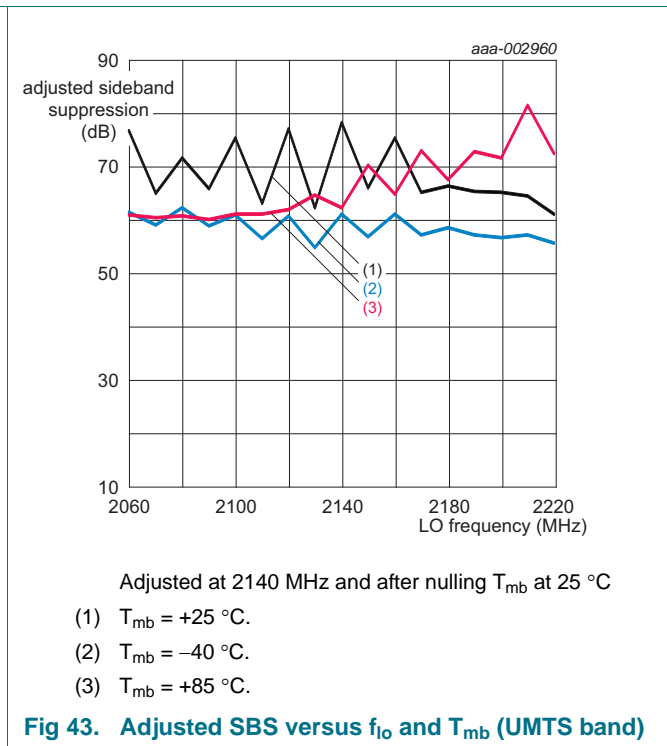
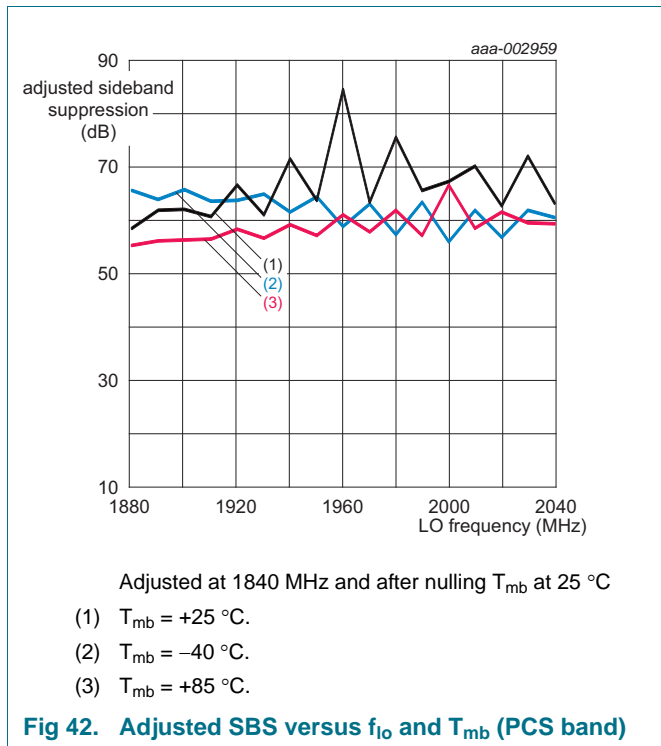
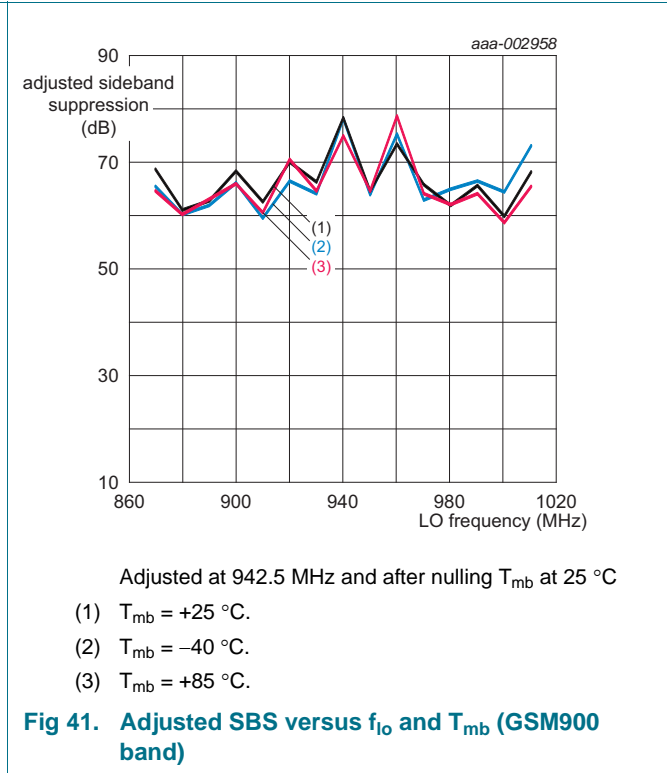
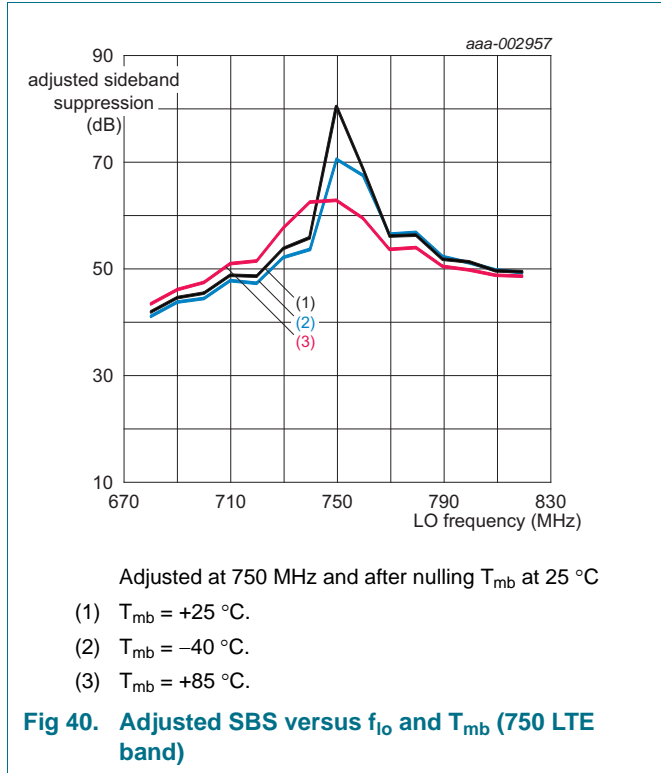

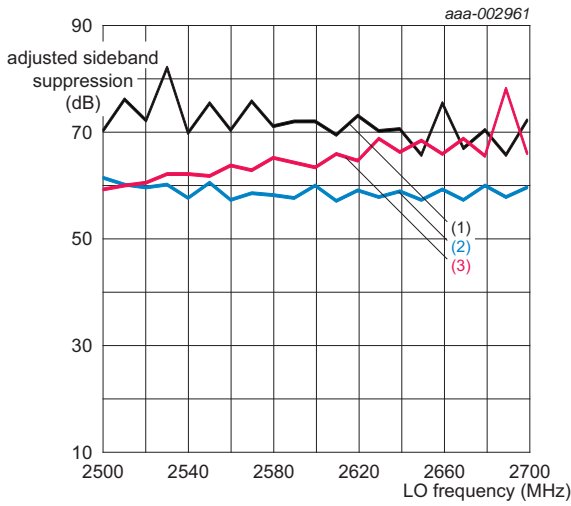

Adjusted at 2600 MHz and after nulling  $T_{mb}$  at 25 °C

- (1)  $T_{mb} = +25$  °C.
- (2)  $T_{mb} = -40$  °C.
- (3)  $T_{mb} = +85$  °C.

**Fig 44. Adjusted SBS versus  $f_{lo}$  and  $T_{mb}$  (2.6 GHz LTE band)**

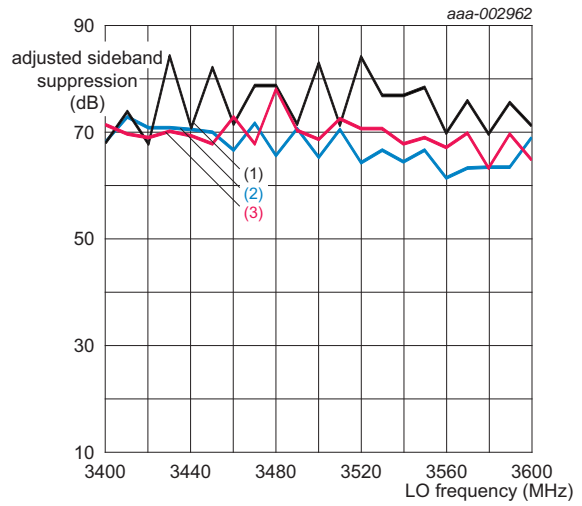

Adjusted at 3500 MHz and after nulling  $T_{mb}$  at 25 °C

- (1)  $T_{mb} = +25$  °C.
- (2)  $T_{mb} = -40$  °C.
- (3)  $T_{mb} = +85$  °C.

**Fig 45. Adjusted SBS versus  $f_{lo}$  and  $T_{mb}$  (Wi MAX/LTE band)**

Parameters for the three following drawings: noise floor without baseband;  $V_{CC} = 5\text{ V}$ ;  $T_{mb} = 25\text{ }^\circ\text{C}$ ;  $P_{i(lo)} = 0\text{ dBm}$ ; offset frequency = 20 MHz; input baseband ports terminated in  $50\ \Omega$ ; unless otherwise specified.

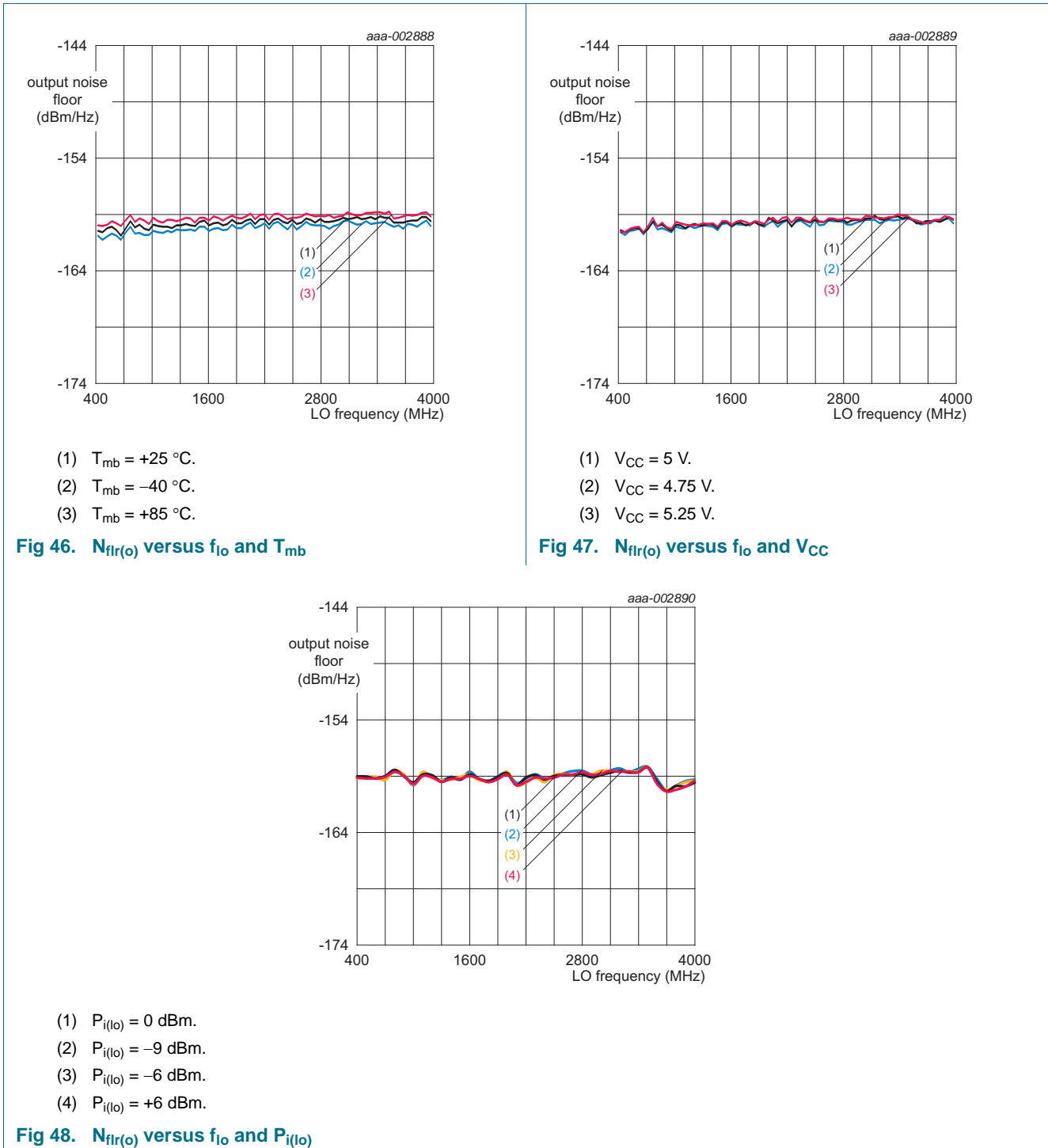

Parameters for the two following drawings: noise floor with baseband;  $V_{CC} = 5\text{ V}$ ;  
 $T_{mb} = 25\text{ }^\circ\text{C}$ ;  $P_{i(lo)} = 0\text{ dBm}$ ; input baseband ports terminated on short circuit to ground for  
 MODI\_N, MODI\_P and MODQ\_N; DC signal on MODQ\_P; unless otherwise specified.

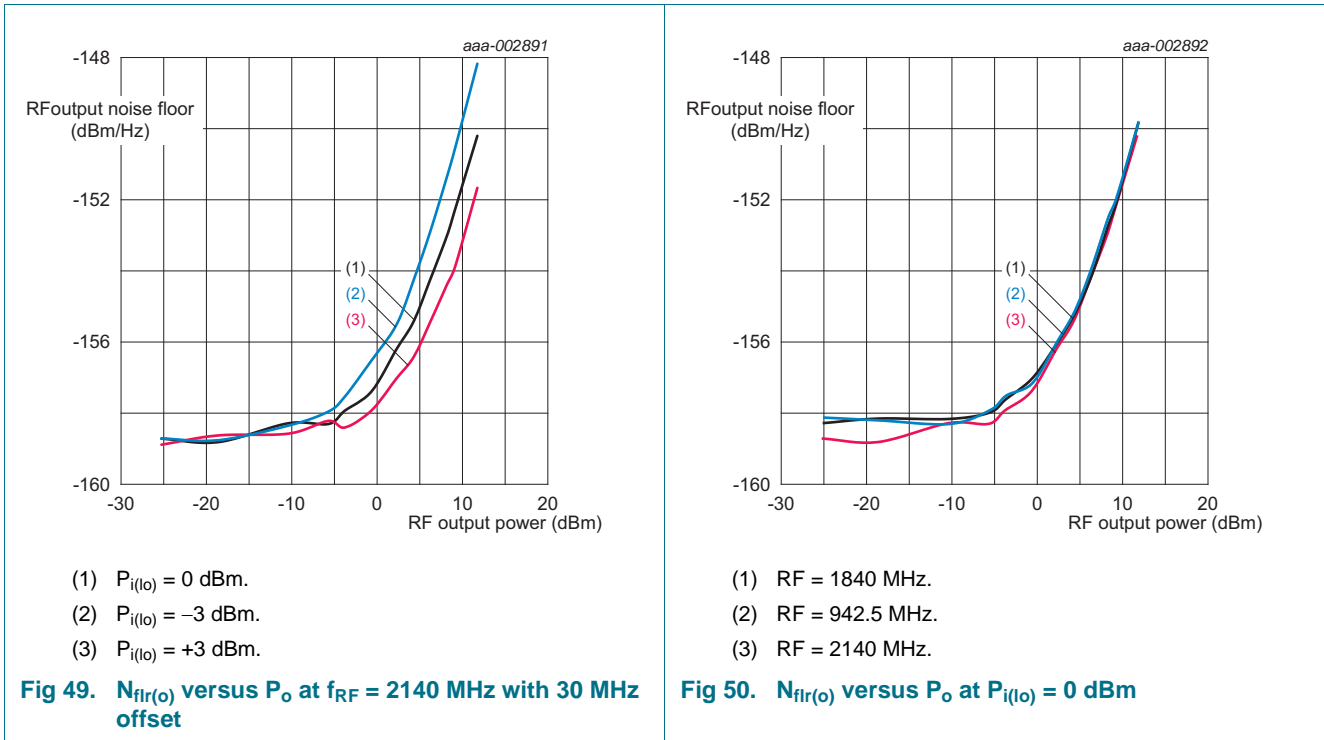
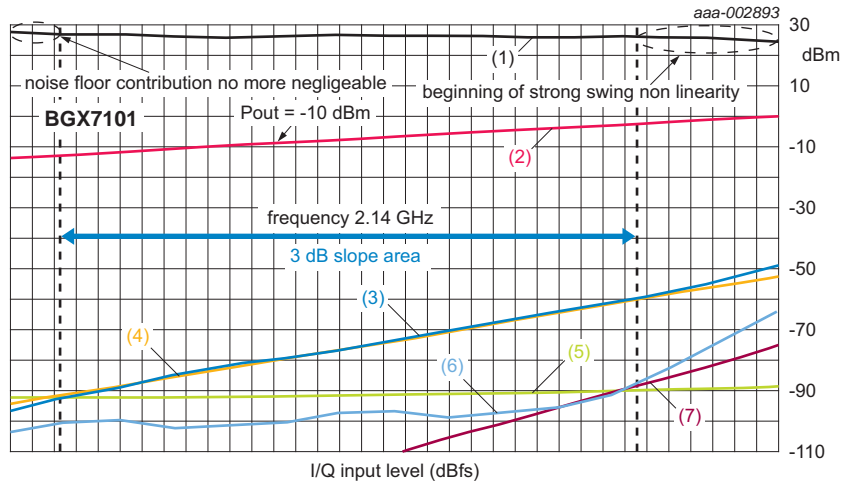

Fig 49.  $N_{f(r_o)}$  versus  $P_o$  at  $f_{RF} = 2140\text{ MHz}$  with 30 MHz offset

Fig 50.  $N_{f(r_o)}$  versus  $P_o$  at  $P_{i(lo)} = 0\text{ dBm}$

Parameters for the following drawing:  $T_{mb} = 25\text{ }^{\circ}\text{C}$ ;  $P_{i(lo)} = 0\text{ dBm}$ ; two tones for IM3, IM5, wanted and IP3<sub>o</sub>; tone 1: IQ frequency = 4.5 MHz and tone 2: IQ frequency = 5.5 MHz;  $V_{i(cm)} = 0.5\text{ V}$ ; for noise floor measurement see preceding conditions; noise floor measurement has been integrated in 3.84 MHz bandwidth; unless otherwise specified.



- (1) Measured IP3<sub>o</sub>.
- (2) P<sub>out</sub>/Tone 1 dB step.
- (3) Measured IM3.
- (4) Trendline IM3.
- (5) Noise floor in 3.84 MHz.
- (6) Measured IM5.
- (7) Trendline IM5.

Fig 51. IP3<sub>o</sub>, wanted, IM3, IM5 tone and noise floor

## 14. Marking

Table 14. Marking codes

Type number	Marking code
BGX7101HN	7101

## 15. Package information

The BGX7101 uses an HVQFN 24-pin package with underside heat spreader ground.

16. Package outline

HVQFN24: plastic thermal enhanced very thin quad flat package; no leads; 24 terminals; body 4 x 4 x 0.85 mm

SOT616-3

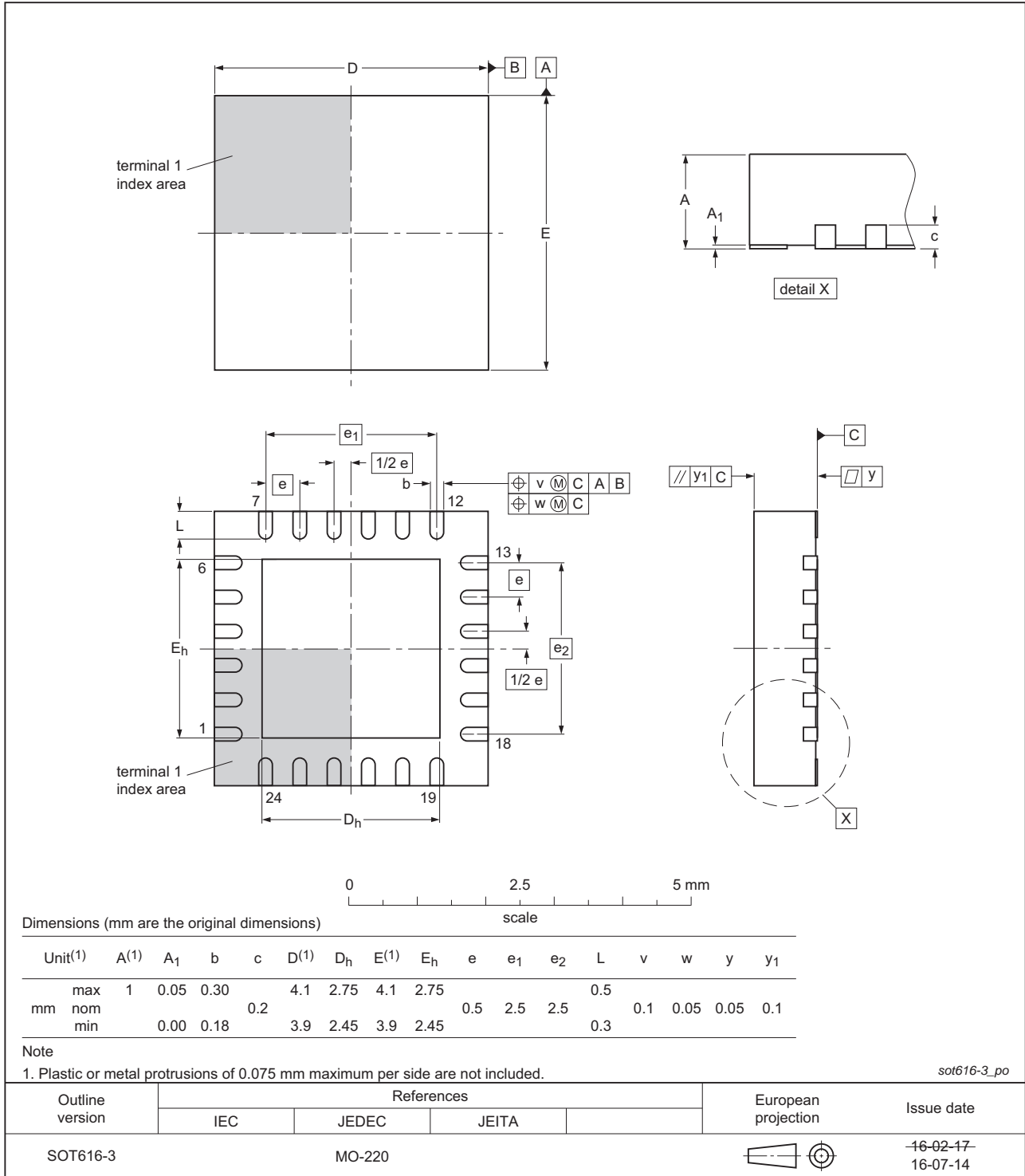

Fig 52. Package outline SOT616-3 (HVQFN24)

## 17. Soldering of SMD packages

This text provides a very brief insight into a complex technology. A more in-depth account of soldering ICs can be found in Application Note *AN10365 "Surface mount reflow soldering description"*.

### 17.1 Introduction to soldering

Soldering is one of the most common methods through which packages are attached to Printed Circuit Boards (PCBs), to form electrical circuits. The soldered joint provides both the mechanical and the electrical connection. There is no single soldering method that is ideal for all IC packages. Wave soldering is often preferred when through-hole and Surface Mount Devices (SMDs) are mixed on one printed wiring board; however, it is not suitable for fine pitch SMDs. Reflow soldering is ideal for the small pitches and high densities that come with increased miniaturization.

### 17.2 Wave and reflow soldering

Wave soldering is a joining technology in which the joints are made by solder coming from a standing wave of liquid solder. The wave soldering process is suitable for the following:

- Through-hole components
- Leaded or leadless SMDs, which are glued to the surface of the printed circuit board

Not all SMDs can be wave soldered. Packages with solder balls, and some leadless packages which have solder lands underneath the body, cannot be wave soldered. Also, leaded SMDs with leads having a pitch smaller than ~0.6 mm cannot be wave soldered, due to an increased probability of bridging.

The reflow soldering process involves applying solder paste to a board, followed by component placement and exposure to a temperature profile. Leaded packages, packages with solder balls, and leadless packages are all reflow solderable.

Key characteristics in both wave and reflow soldering are:

- Board specifications, including the board finish, solder masks and vias
- Package footprints, including solder thieves and orientation
- The moisture sensitivity level of the packages
- Package placement
- Inspection and repair
- Lead-free soldering versus SnPb soldering

### 17.3 Wave soldering

Key characteristics in wave soldering are:

- Process issues, such as application of adhesive and flux, clinching of leads, board transport, the solder wave parameters, and the time during which components are exposed to the wave
- Solder bath specifications, including temperature and impurities

### 17.4 Reflow soldering

Key characteristics in reflow soldering are:

- Lead-free versus SnPb soldering; note that a lead-free reflow process usually leads to higher minimum peak temperatures (see [Figure 53](#)) than a SnPb process, thus reducing the process window
- Solder paste printing issues including smearing, release, and adjusting the process window for a mix of large and small components on one board
- Reflow temperature profile; this profile includes preheat, reflow (in which the board is heated to the peak temperature) and cooling down. It is imperative that the peak temperature is high enough for the solder to make reliable solder joints (a solder paste characteristic). In addition, the peak temperature must be low enough that the packages and/or boards are not damaged. The peak temperature of the package depends on package thickness and volume and is classified in accordance with [Table 15](#) and [16](#)

**Table 15. SnPb eutectic process (from J-STD-020D)**

Package thickness (mm)	Package reflow temperature (°C)	
	Volume (mm <sup>3</sup> )	
	< 350	≥ 350
< 2.5	235	220
≥ 2.5	220	220

**Table 16. Lead-free process (from J-STD-020D)**

Package thickness (mm)	Package reflow temperature (°C)		
	Volume (mm <sup>3</sup> )		
	< 350	350 to 2000	> 2000
< 1.6	260	260	260
1.6 to 2.5	260	250	245
> 2.5	250	245	245

Moisture sensitivity precautions, as indicated on the packing, must be respected at all times.

Studies have shown that small packages reach higher temperatures during reflow soldering, see [Figure 53](#).

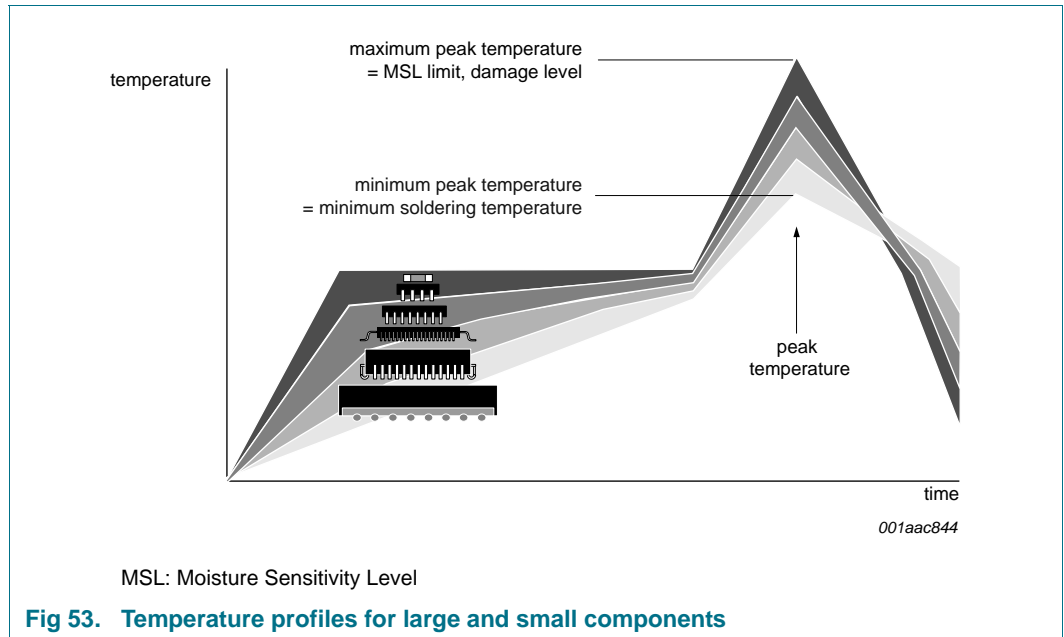

For further information on temperature profiles, refer to Application Note AN10365 “Surface mount reflow soldering description”.

## 18. Abbreviations

**Table 17. Abbreviations**

Acronym	Description
DAC	Digital-to-Analog Converter
DC	Direct Current
ESD	ElectroStatic Discharge
FCDM	Field-induced Charged-Device Model
HBM	Human Body Model
IF	Intermediate Frequency
LO	Local Oscillator
PCB	Printed-Circuit Board
RF	Radio Frequency
TDD	Time Division Duplex

## 19. Revision history

**Table 18. Revision history**

Document ID	Release date	Data sheet status	Change notice	Supersedes
BGX7101 v.5	20170125	Product data sheet	-	BGX7101 v.4
Modifications:	<ul style="list-style-type: none"> <li>• <a href="#">Section 1</a>: added BTS8001A according to our new naming convention</li> </ul>			
BGX7101 v.4	20130110	Product data sheet	-	BGX7101 v.3
Modifications:	<ul style="list-style-type: none"> <li>• <a href="#">Table 7</a>: updated</li> <li>• <a href="#">Table 8</a>: updated</li> <li>• <a href="#">Table 9</a>: updated</li> <li>• <a href="#">Table 10</a>: updated</li> <li>• <a href="#">Table 11</a>: updated</li> <li>• <a href="#">Table 12</a>: updated</li> <li>• <a href="#">Table 13</a>: updated</li> </ul>			
BGX7101 v.3	20120903	Product data sheet	-	BGX7101 v.2
BGX7101 v.2	20120809	Product data sheet	-	BGX7101 v.1
BGX7101 v.1	20120425	Product data sheet	-	-

## 20. Legal information

### 20.1 Data sheet status

Document status <sup>[1][2]</sup>	Product status <sup>[3]</sup>	Definition
Objective [short] data sheet	Development	This document contains data from the objective specification for product development.
Preliminary [short] data sheet	Qualification	This document contains data from the preliminary specification.
Product [short] data sheet	Production	This document contains the product specification.

[1] Please consult the most recently issued document before initiating or completing a design.

[2] The term 'short data sheet' is explained in section "Definitions".

[3] The product status of device(s) described in this document may have changed since this document was published and may differ in case of multiple devices. The latest product status information is available on the Internet at URL <http://www.nxp.com>.

### 20.2 Definitions

**Draft** — The document is a draft version only. The content is still under internal review and subject to formal approval, which may result in modifications or additions. NXP Semiconductors does not give any representations or warranties as to the accuracy or completeness of information included herein and shall have no liability for the consequences of use of such information.

**Short data sheet** — A short data sheet is an extract from a full data sheet with the same product type number(s) and title. A short data sheet is intended for quick reference only and should not be relied upon to contain detailed and full information. For detailed and full information see the relevant full data sheet, which is available on request via the local NXP Semiconductors sales office. In case of any inconsistency or conflict with the short data sheet, the full data sheet shall prevail.

**Product specification** — The information and data provided in a Product data sheet shall define the specification of the product as agreed between NXP Semiconductors and its customer, unless NXP Semiconductors and customer have explicitly agreed otherwise in writing. In no event however, shall an agreement be valid in which the NXP Semiconductors product is deemed to offer functions and qualities beyond those described in the Product data sheet.

### 20.3 Disclaimers

**Limited warranty and liability** — Information in this document is believed to be accurate and reliable. However, NXP Semiconductors does not give any representations or warranties, expressed or implied, as to the accuracy or completeness of such information and shall have no liability for the consequences of use of such information. NXP Semiconductors takes no responsibility for the content in this document if provided by an information source outside of NXP Semiconductors.

In no event shall NXP Semiconductors be liable for any indirect, incidental, punitive, special or consequential damages (including - without limitation - lost profits, lost savings, business interruption, costs related to the removal or replacement of any products or rework charges) whether or not such damages are based on tort (including negligence), warranty, breach of contract or any other legal theory.

Notwithstanding any damages that customer might incur for any reason whatsoever, NXP Semiconductors' aggregate and cumulative liability towards customer for the products described herein shall be limited in accordance with the *Terms and conditions of commercial sale* of NXP Semiconductors.

**Right to make changes** — NXP Semiconductors reserves the right to make changes to information published in this document, including without limitation specifications and product descriptions, at any time and without notice. This document supersedes and replaces all information supplied prior to the publication hereof.

**Suitability for use** — NXP Semiconductors products are not designed, authorized or warranted to be suitable for use in life support, life-critical or safety-critical systems or equipment, nor in applications where failure or malfunction of an NXP Semiconductors product can reasonably be expected to result in personal injury, death or severe property or environmental damage. NXP Semiconductors and its suppliers accept no liability for inclusion and/or use of NXP Semiconductors products in such equipment or applications and therefore such inclusion and/or use is at the customer's own risk.

**Applications** — Applications that are described herein for any of these products are for illustrative purposes only. NXP Semiconductors makes no representation or warranty that such applications will be suitable for the specified use without further testing or modification.

Customers are responsible for the design and operation of their applications and products using NXP Semiconductors products, and NXP Semiconductors accepts no liability for any assistance with applications or customer product design. It is customer's sole responsibility to determine whether the NXP Semiconductors product is suitable and fit for the customer's applications and products planned, as well as for the planned application and use of customer's third party customer(s). Customers should provide appropriate design and operating safeguards to minimize the risks associated with their applications and products.

NXP Semiconductors does not accept any liability related to any default, damage, costs or problem which is based on any weakness or default in the customer's applications or products, or the application or use by customer's third party customer(s). Customer is responsible for doing all necessary testing for the customer's applications and products using NXP Semiconductors products in order to avoid a default of the applications and the products or of the application or use by customer's third party customer(s). NXP does not accept any liability in this respect.

**Limiting values** — Stress above one or more limiting values (as defined in the Absolute Maximum Ratings System of IEC 60134) will cause permanent damage to the device. Limiting values are stress ratings only and (proper) operation of the device at these or any other conditions above those given in the Recommended operating conditions section (if present) or the Characteristics sections of this document is not warranted. Constant or repeated exposure to limiting values will permanently and irreversibly affect the quality and reliability of the device.

**Terms and conditions of commercial sale** — NXP Semiconductors products are sold subject to the general terms and conditions of commercial sale, as published at <http://www.nxp.com/profile/terms>, unless otherwise agreed in a valid written individual agreement. In case an individual agreement is concluded only the terms and conditions of the respective agreement shall apply. NXP Semiconductors hereby expressly objects to applying the customer's general terms and conditions with regard to the purchase of NXP Semiconductors products by customer.

**No offer to sell or license** — Nothing in this document may be interpreted or construed as an offer to sell products that is open for acceptance or the grant, conveyance or implication of any license under any copyrights, patents or other industrial or intellectual property rights.

**Export control** — This document as well as the item(s) described herein may be subject to export control regulations. Export might require a prior authorization from competent authorities.

**Non-automotive qualified products** — Unless this data sheet expressly states that this specific NXP Semiconductors product is automotive qualified, the product is not suitable for automotive use. It is neither qualified nor tested in accordance with automotive testing or application requirements. NXP Semiconductors accepts no liability for inclusion and/or use of non-automotive qualified products in automotive equipment or applications.

In the event that customer uses the product for design-in and use in automotive applications to automotive specifications and standards, customer (a) shall use the product without NXP Semiconductors' warranty of the product for such automotive applications, use and specifications, and (b) whenever customer uses the product for automotive applications beyond

NXP Semiconductors' specifications such use shall be solely at customer's own risk, and (c) customer fully indemnifies NXP Semiconductors for any liability, damages or failed product claims resulting from customer design and use of the product for automotive applications beyond NXP Semiconductors' standard warranty and NXP Semiconductors' product specifications.

**Translations** — A non-English (translated) version of a document is for reference only. The English version shall prevail in case of any discrepancy between the translated and English versions.

## 20.4 Trademarks

Notice: All referenced brands, product names, service names and trademarks are the property of their respective owners.

## 21. Contact information

For more information, please visit: <http://www.nxp.com>

For sales office addresses, please send an email to: [salesaddresses@nxp.com](mailto:salesaddresses@nxp.com)

## 22. Tables

---

Table 1.	Ordering information	2
Table 2.	Pin description	3
Table 3.	Shutdown control	4
Table 4.	Limiting values	5
Table 5.	Thermal characteristics	6
Table 6.	Characteristics	6
Table 7.	Characteristics at 750 MHz	7
Table 8.	Characteristics at 910 MHz	7
Table 9.	Characteristics at 1.840 GHz	8
Table 10.	Characteristics at 1.960 GHz	9
Table 11.	Characteristics at 2.140 GHz	9
Table 12.	Characteristics at 2.650 GHz	10
Table 13.	Characteristics at 3.650 GHz	11
Table 14.	Marking codes	30
Table 15.	SnPb eutectic process (from J-STD-020C)	33
Table 16.	Lead-free process (from J-STD-020C)	33
Table 17.	Abbreviations	34
Table 18.	Revision history	35

## 23. Figures

Fig 1. Functional block diagram. . . . .	2		
Fig 2. Pin configuration . . . . .	3		
Fig 3. LO input return loss variation (S11_LO). . . . .	5		
Fig 4. Typical wideband application diagram. . . . .	12		
Fig 5. Typical interface. . . . .	13		
Fig 6. Current consumption versus $f_{lo}$ and $T_{mb}$ . . . . .	14		
Fig 7. $P_o$ versus $f_{lo}$ and $T_{mb}$ . . . . .	15		
Fig 8. $P_o$ versus $f_{lo}$ and $V_{CC}$ . . . . .	15		
Fig 9. $P_o$ versus $f_{lo}$ and $P_{i(lo)}$ . . . . .	15		
Fig 10. $P_o$ versus $f_{lo}$ and $V_{i(cm)}$ . . . . .	15		
Fig 11. $P_o$ versus baseband voltage at 2140 MHz. . . . .	16		
Fig 12. $P_{L(1dB)}$ versus $f_{lo}$ and $T_{mb}$ . . . . .	17		
Fig 13. $P_{L(1dB)}$ versus $f_{lo}$ and $V_{CC}$ . . . . .	17		
Fig 14. $P_{L(1dB)}$ versus $f_{lo}$ and $P_{i(lo)}$ . . . . .	17		
Fig 15. $P_{L(1dB)}$ versus $f_{lo}$ and $V_{i(cm)}$ . . . . .	17		
Fig 16. $IP3_o$ versus $f_{lo}$ and $T_{mb}$ . . . . .	18		
Fig 17. $IP3_o$ versus $f_{lo}$ and $V_{CC}$ . . . . .	18		
Fig 18. $IP3_o$ versus $f_{lo}$ and $P_{i(lo)}$ . . . . .	18		
Fig 19. $IP3_o$ versus $f_{lo}$ and $V_{i(cm)}$ . . . . .	18		
Fig 20. $IP2_o$ versus $f_{lo}$ and $T_{mb}$ . . . . .	19		
Fig 21. $IP2_o$ versus $f_{lo}$ and $V_{CC}$ . . . . .	19		
Fig 22. $IP2_o$ versus $f_{lo}$ and $P_{i(lo)}$ . . . . .	19		
Fig 23. $IP2_o$ versus $f_{lo}$ and $V_{i(cm)}$ . . . . .	19		
Fig 24. Unadjusted CF versus $f_{lo}$ and $T_{mb}$ . . . . .	20		
Fig 25. Unadjusted CF versus $f_{lo}$ and $V_{CC}$ . . . . .	20		
Fig 26. Unadjusted CF versus $f_{lo}$ and $P_{i(lo)}$ . . . . .	20		
Fig 27. Unadjusted CF versus $f_{lo}$ and $V_{i(cm)}$ . . . . .	20		
Fig 28. Adjusted CF versus $f_{lo}$ and $T_{mb}$ after nulling at 25 °C . . . . .	21		
Fig 29. Unadjusted SBS versus $f_{lo}$ and $T_{mb}$ . . . . .	22		
Fig 30. Unadjusted SBS versus $f_{lo}$ and $V_{CC}$ . . . . .	22		
Fig 31. Unadjusted SBS versus $f_{lo}$ and $P_{i(lo)}$ . . . . .	22		
Fig 32. Unadjusted SBS versus $f_{lo}$ and $V_{i(cm)}$ . . . . .	22		
Fig 33. Adjusted SBS versus $f_{lo}$ and $T_{mb}$ after nulling at 25 °C . . . . .	23		
Fig 34. Adjusted CF versus $f_{lo}$ and $T_{mb}$ (750 LTE band) . . . . .	24		
Fig 35. Adjusted CF versus $f_{lo}$ and $T_{mb}$ (GSM band) . . . . .	24		
Fig 36. Adjusted CF versus $f_{lo}$ and $T_{mb}$ (PCS band) . . . . .	24		
Fig 37. Adjusted CF versus $f_{lo}$ and $T_{mb}$ (UMTS band) . . . . .	24		
Fig 38. Adjusted CF versus $f_{lo}$ and $T_{mb}$ (2.6 GHz LTE band) . . . . .	25		
Fig 39. Adjusted CF versus $f_{lo}$ and $T_{mb}$ (Wi MAX/LTE band) . . . . .	25		
Fig 40. Adjusted SBS versus $f_{lo}$ and $T_{mb}$ (750 LTE band) . . . . .	26		
Fig 41. Adjusted SBS versus $f_{lo}$ and $T_{mb}$ (GSM900 band) . . . . .	26		
Fig 42. Adjusted SBS versus $f_{lo}$ and $T_{mb}$ (PCS band) . . . . .	26		
Fig 43. Adjusted SBS versus $f_{lo}$ and $T_{mb}$ (UMTS band) . . . . .	26		
Fig 44. Adjusted SBS versus $f_{lo}$ and $T_{mb}$ (2.6 GHz LTE band) . . . . .	27		
Fig 45. Adjusted SBS versus $f_{lo}$ and $T_{mb}$ (Wi MAX/LTE band). . . . .	27		
Fig 46. $N_{flr(o)}$ versus $f_{lo}$ and $T_{mb}$ . . . . .	28		
Fig 47. $N_{flr(o)}$ versus $f_{lo}$ and $V_{CC}$ . . . . .	28		
Fig 48. $N_{flr(o)}$ versus $f_{lo}$ and $P_{i(lo)}$ . . . . .	28		
Fig 49. $N_{flr(o)}$ versus $P_o$ at $f_{RF} = 2140$ MHz with 30 MHz offset . . . . .	29		
Fig 50. $N_{flr(o)}$ versus $P_o$ at $P_{i(lo)} = 0$ dBm . . . . .	29		
Fig 51. $IP3_o$ , wanted, IM3, IM5 tone and noise floor . . . . .	30		
Fig 52. Package outline SOT616-3 (HVQFN24) . . . . .	31		
Fig 53. Temperature profiles for large and small components. . . . .	34		

## 24. Contents

<b>1</b>	<b>General description</b> .....	<b>1</b>
<b>2</b>	<b>Features and benefits</b> .....	<b>1</b>
<b>3</b>	<b>Applications</b> .....	<b>1</b>
<b>4</b>	<b>Device family</b> .....	<b>1</b>
<b>5</b>	<b>Ordering information</b> .....	<b>2</b>
<b>6</b>	<b>Functional diagram</b> .....	<b>2</b>
<b>7</b>	<b>Pinning information</b> .....	<b>2</b>
7.1	Pinning .....	2
7.2	Pin description .....	3
<b>8</b>	<b>Functional description</b> .....	<b>4</b>
8.1	General .....	4
8.2	Shutdown control .....	4
<b>9</b>	<b>Limiting values</b> .....	<b>5</b>
<b>10</b>	<b>Thermal characteristics</b> .....	<b>6</b>
<b>11</b>	<b>Characteristics</b> .....	<b>6</b>
<b>12</b>	<b>Application information</b> .....	<b>12</b>
12.1	External DAC interfacing .....	12
12.2	RF .....	13
<b>13</b>	<b>Test information</b> .....	<b>14</b>
<b>14</b>	<b>Marking</b> .....	<b>30</b>
<b>15</b>	<b>Package information</b> .....	<b>30</b>
<b>16</b>	<b>Package outline</b> .....	<b>31</b>
<b>17</b>	<b>Soldering of SMD packages</b> .....	<b>32</b>
17.1	Introduction to soldering .....	32
17.2	Wave and reflow soldering .....	32
17.3	Wave soldering .....	32
17.4	Reflow soldering .....	33
<b>18</b>	<b>Abbreviations</b> .....	<b>34</b>
<b>19</b>	<b>Revision history</b> .....	<b>35</b>
<b>20</b>	<b>Legal information</b> .....	<b>36</b>
20.1	Data sheet status .....	36
20.2	Definitions .....	36
20.3	Disclaimers .....	36
20.4	Trademarks .....	37
<b>21</b>	<b>Contact information</b> .....	<b>37</b>
<b>22</b>	<b>Tables</b> .....	<b>38</b>
<b>23</b>	<b>Figures</b> .....	<b>39</b>
<b>24</b>	<b>Contents</b> .....	<b>40</b>

Please be aware that important notices concerning this document and the product(s) described herein, have been included in section 'Legal information'.

© NXP B.V. 2017.

All rights reserved.

For more information, please visit: <http://www.nxp.com>



For sales office addresses, please send an email to: [salesaddresses@nxp.com](mailto:salesaddresses@nxp.com)

Date of release: 25 January 2017





Document identifier: BGX7101

## Looking for pricing, stock, or lifecycle information?

Click below to explore more details on WIN SOURCE:

-  [View BGX7101HN/1,118 on WIN SOURCE](#)
-  [NXP / Nexperia Information](#)

## Optimize Your Supply Chain with WIN SOURCE Solutions

-  Global Sourcing Solution
-  Obsolete Management
-  Cost Control Management
-  Shortage Management
-  Alternative Solution
-  Excess Inventory Management