



**THE DATASHEET OF  
LM3519MK-20/NOPB**



# LM3519 High Frequency Boost White LED Driver with High-Speed PWM Brightness Control

Check for Samples: [LM3519](#)

## FEATURES

- Drives 2 to 4 LEDs at 20mA
- Up to 30kHz PWM Dimming Control Capability
- >80% Peak Efficiency
- Up to 8MHz Switching Frequency
- Small External Components: 1 $\mu$ H - 3.3 $\mu$ H(typ.2.2 $\mu$ H) Inductor and 1 $\mu$ F Output Capacitor
- True Shutdown Isolation
- Over-Voltage Protection
- Wide Input Voltage Range: 2.7V to 5.5V
- Small Footprint SOT-23 Package

## APPLICATIONS

- LCD, White LED Backlighting on Mobile Phones
- Digital Still Cameras and PDAs
- General Purpose LED Lighting in Handheld Devices

## Typical Application

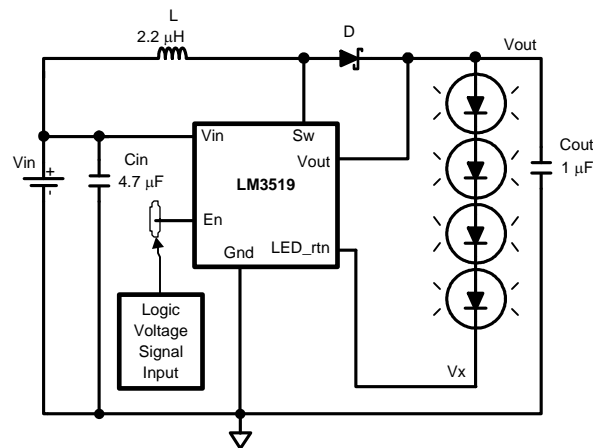
**Figure 1. Typical Application Circuit**

## DESCRIPTION

The LM3519 drives up to 4 white LEDs with constant current to provide LCD backlighting in handheld devices. The LED current is internally set to 20mA. The series connection allows the LED current to be identical for uniform brightness and minimizes the number of traces to the LEDs. Brightness control is achieved by applying a PWM signal on enable with frequencies up to 30kHz.

The LM3519 features a proprietary PFM regulation architecture with switching frequencies between 2MHz to 8MHz, minimizing inductor size.

Over-voltage protection circuitry and high frequency operation permit the use of low-cost small output capacitors. During shutdown, the output is disconnected from the input in order to avoid leakage current path through the LEDs to ground.

The LM3519 is available in a tiny 6-pin SOT-23 package.



Please be aware that an important notice concerning availability, standard warranty, and use in critical applications of Texas Instruments semiconductor products and disclaimers thereto appears at the end of this data sheet.

All trademarks are the property of their respective owners.

## Connection Diagram

### 6-Lead SOT-23 Package

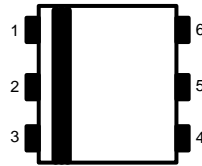

Top View

### PIN DESCRIPTIONS

Pin #	Name	Description
1	En	Device Enable Connection
2	Gnd	Ground Connection
3	V <sub>OUT</sub>	Output Voltage Connection
4	LED_rtn	White LED Current Sensing Input Connection
5	S <sub>W</sub>	Drain Connection of the Internal Power Field Effect Transistor (FET) Switch
6	V <sub>IN</sub>	Input or Supply Voltage Connection



These devices have limited built-in ESD protection. The leads should be shorted together or the device placed in conductive foam during storage or handling to prevent electrostatic damage to the MOS gates.

### Absolute Maximum Ratings<sup>(1)</sup>

V <sub>IN</sub> , En, & LED_rtn Pin	-0.3V to +6.5V
V <sub>OUT</sub> , Sw Pin	-0.3V to +21V
Maximum Junction Temperature, (T <sub>J-MAX</sub> )	+150°C
Storage Temperature Range	-65°C to +150°C
ESD Rating <sup>(2)</sup>	
Human Body Model:	2kV
Machine Model:	200V

- (1) [Absolute maximum ratings](#) indicate limits beyond which damage to the device may occur. [Operating Ratings](#) are conditions under which operation of the device is ensured. Operating Ratings do not imply ensured limits. For ensured performance limits and associated test conditions, see the [Electrical Characteristics](#) table.
- (2) The human body model is a 100pF capacitor discharged through a 1.5kΩ resistor into each pin. The machine model is a 200pF capacitor discharged directly into each pin.

### Operating Ratings<sup>(1)</sup>

Junction Temperature (T <sub>J</sub> ) Range	-40°C to +125°C
Ambient Temperature (T <sub>A</sub> ) Range	-40°C to +85°C
Input Voltage Range	2.7V to 5.5V

- (1) [Absolute maximum ratings](#) indicate limits beyond which damage to the device may occur. [Operating Ratings](#) are conditions under which operation of the device is ensured. Operating Ratings do not imply ensured limits. For ensured performance limits and associated test conditions, see the [Electrical Characteristics](#) table.

### Thermal Properties<sup>(1)</sup>

Junction-to-Ambient Thermal Resistance (θ <sub>JA</sub> )	220°C/W
---	---------

- (1) The maximum allowable power dissipation is a function of the maximum junction temperature, T<sub>J(MAX)</sub>, the junction-to-ambient thermal resistance, θ<sub>JA</sub>, and the ambient temperature, T<sub>A</sub>. See [Thermal Properties](#) for the thermal resistance. The maximum allowable power dissipation at any ambient temperature is calculated using: P<sub>D(MAX)</sub> = (T<sub>J(MAX)</sub> – T<sub>A</sub>)/θ<sub>JA</sub>. Exceeding the maximum allowable power dissipation will cause excessive die temperature.

**Electrical Characteristics** <sup>(1)(2)</sup>

Limits in standard typeface are for  $T_J = +25^\circ\text{C}$ . Limits in **bold typeface** apply over the full operating junction temperature range ( $-40^\circ\text{C} \leq T_J \leq +125^\circ\text{C}$ ).  $V_{IN} = 3.6\text{V}$ , unless otherwise stated.

Symbol	Parameter	Conditions	Min	Typ	Max	Units
$I_Q$	Supply Current	Shutdown: $V_{EN} = 0\text{V}$		0.1		$\mu\text{A}$
		Not Switching: $V_{EN} = 1.8\text{V}$		360	<b>500</b>	
		Switching: $V_{EN} = 1.8\text{V}$ , LED_rtn current = 30mA		550	<b>900</b>	
$I_{LED(TOL)}$	LED Current Tolerance/Variation	$V_{IN} = 3.6\text{V}$ , 2.2 $\mu\text{H}$ , 4LEDs	<b>-10</b>	5.5	<b>10</b>	%
OVP	Over-Voltage Protection Threshold	OVP ON OVP OFF	<b>18</b> <b>17.8</b>	18.9 18.6	<b>20</b> <b>19.8</b>	V
$I_{LIM}$	Switch Current Limit	$L = 2.2\mu\text{H}$		750		mA
$R_{DS(ON)}$	Power NMOS Switch ON Resistance			455		m $\Omega$
$I_{LEAKAGE}$	Switch Leakage	$V_{SW} = 3.6\text{V}$ , $V_{EN} = 0\text{V}$		0.1	<b>2</b>	$\mu\text{A}$
$R_{LED\_rtn(ON)}$	LED_rtn NMOS Switch ON Resistance			8.0		$\Omega$
$F_S$	Switching Frequency	$I_{LED} = 20\text{ mA}$ , $L = 1\mu\text{H}$ 4LEDs		5.4		MHz
$I_{EN}$	Enable Pin Bias Current <sup>(3)</sup>	$V_{EN} = 0\text{V}$ $V_{EN} = 1.8\text{V}$		0.1 1.1	<b>2</b>	$\mu\text{A}$
En	Enable Threshold	Device On Device Off	<b>0.9</b>		<b>0.3</b>	V

- (1) [Absolute maximum ratings](#) indicate limits beyond which damage to the device may occur. [Operating Ratings](#) are conditions under which operation of the device is ensured. Operating Ratings do not imply ensured limits. For ensured performance limits and associated test conditions, see the [Electrical Characteristics](#) table.
- (2) Min and max limits are ensured by design, test, or statistical analysis. Typical numbers are not ensured, but do represent the most likely norm.
- (3) Current flows into the pin.

## BLOCK DIAGRAM

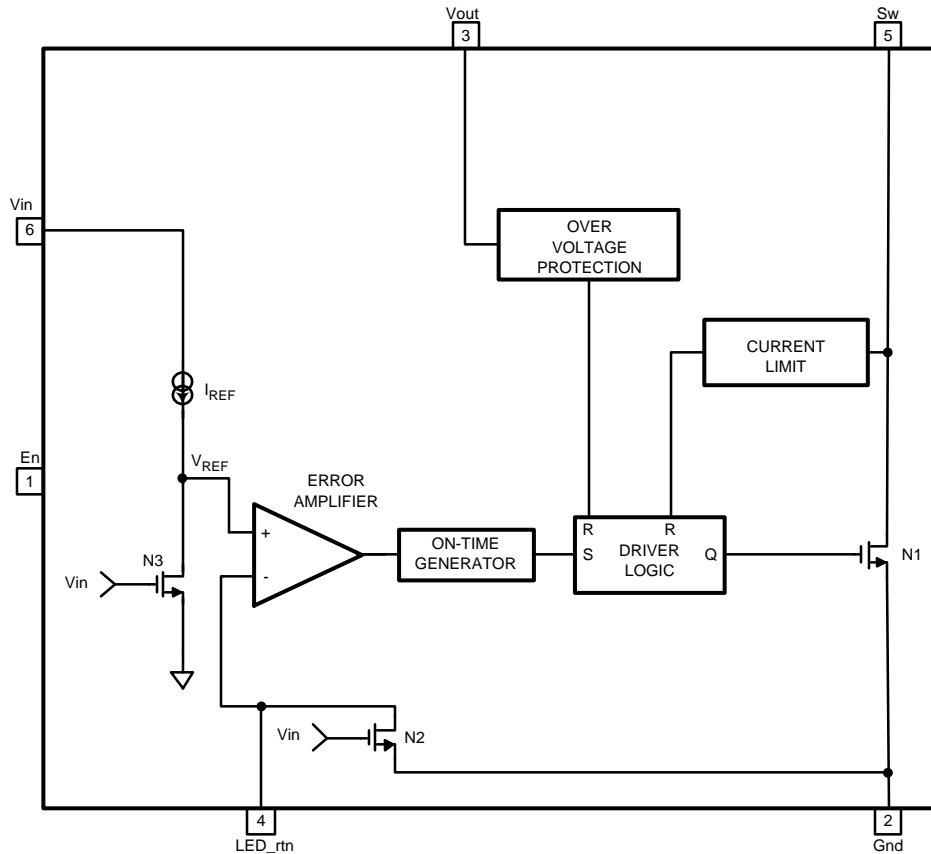

Figure 2. Block Diagram

### Circuit Description

The LM3519 is a step-up converter for white LED applications that uses a unique and proprietary pulse frequency modulation (PFM) architecture to optimize high efficiency at high frequency operation. Unlike most PFM architecture implementations, the LM3519's unique architectural implementation results in non-pulse skipping variable frequency operation. The regulator is forced to operate at the edge of Continuous Conduction Mode (CCM). The error amplifier will set the end of the on-time ( $I_{PEAK}$  of inductor) based on the load (LEDs) current. During this operation, the inductor current ramps up and reaches a peak current at end of the on-time. At this point, the internal power switch is turned off until the inductor current reaches zero, and the cycle repeats again. The switching frequency is set based on the charge (on-time) and discharge(off-time) of the inductor current. The frequency can range between 2MHz to 8MHz over the operating input range.

The LM3519 operation can be best understood through an examination of the block diagram in [Figure 2](#). When LED current is out of regulation, the LED\_rtn voltage falls below or rises above the internal reference voltage ( $V_{REF}$ ). The error amplifier will output a signal to increase or decrease the proper on-time duration of N1 power FET. This correction allows the inductor's stored energy to increase or decrease to a sufficient level that when transferred to the load will bring the LED\_rtn current back into regulation.

During steady-state operation for a typical switching cycle, the oscillator sets the driver logic and turns on N1 power device. N1 conducts current through the inductor and reverse biases the external diode. The LED current is supplied by the output capacitor when N1 is conducting. Once N1 on-time period is concluded, the internal power device is turned off and the external diode is forward biased. The inductor current then flows through the diode to the LED load to replenish the output capacitor and keep the LED current regulated at the trimmed target.

### Typical Performance Characteristics

(See Figure 1:  $V_{IN} = 3.6V$ ,  $C_{IN} = 4.7\mu F$  and  $C_{OUT} = 1\mu F$ ,  $L = 2.2\mu H$  and 4 LEDs.  $T_A = +25^\circ C$ , unless otherwise stated.)

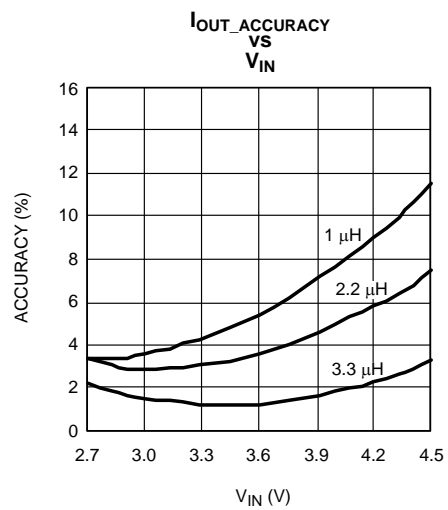
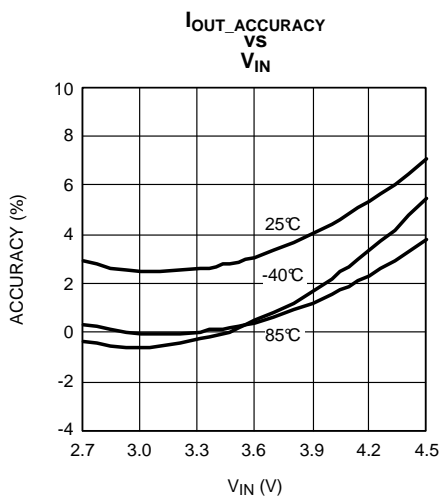
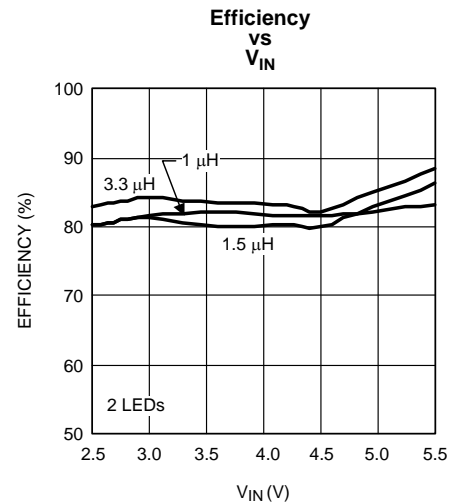
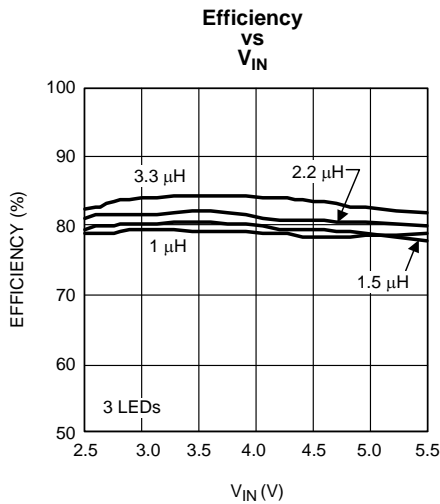
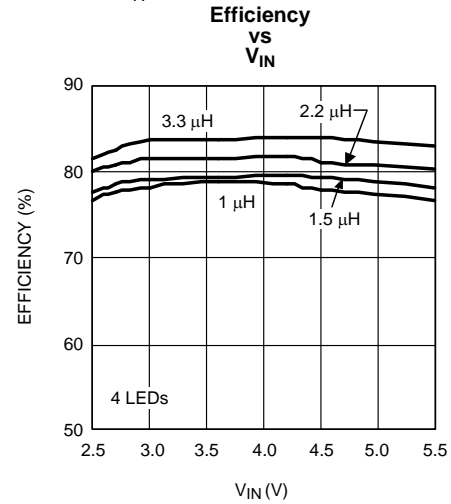
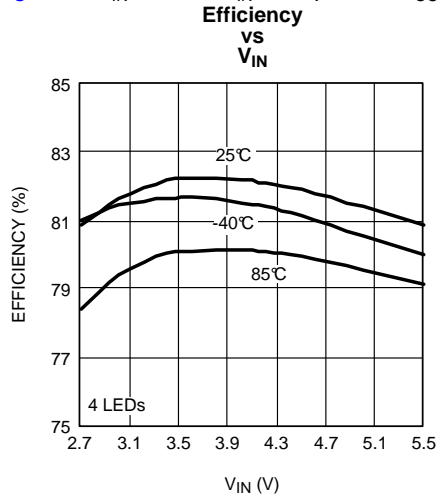

**Typical Performance Characteristics (continued)**

(See Figure 1:  $V_{IN} = 3.6V$ ,  $C_{IN} = 4.7\mu F$  and  $C_{OUT} = 1\mu F$ ,  $L = 2.2\mu H$  and 4 LEDs.  $T_A = +25^\circ C$ , unless otherwise stated.)

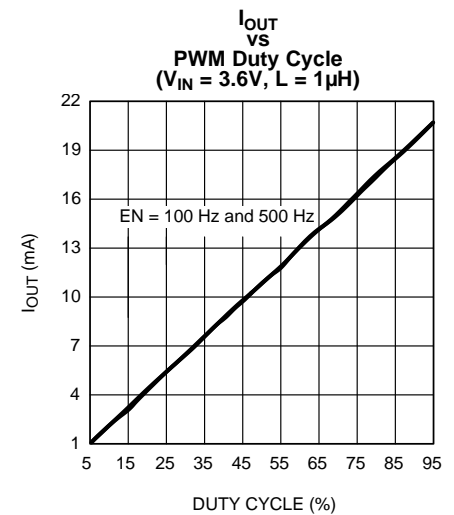
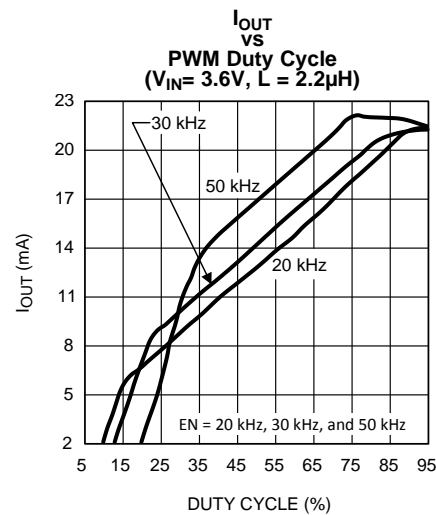
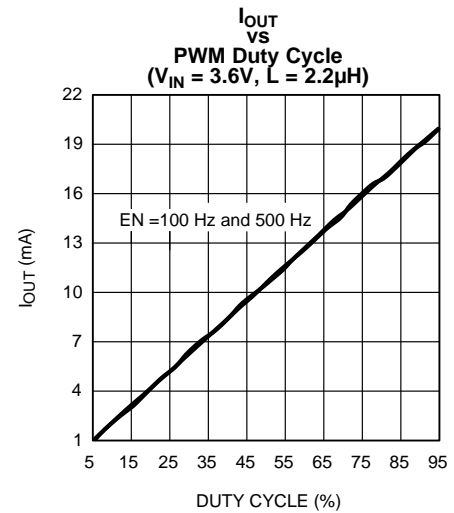
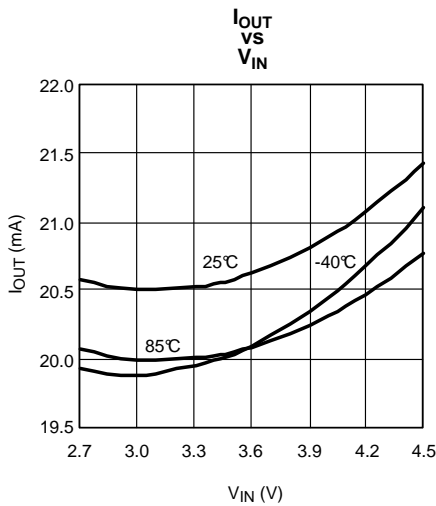
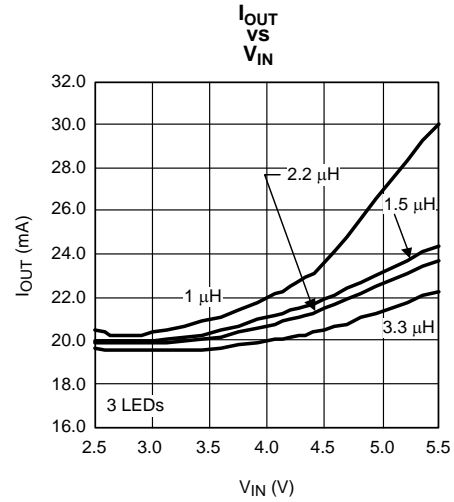
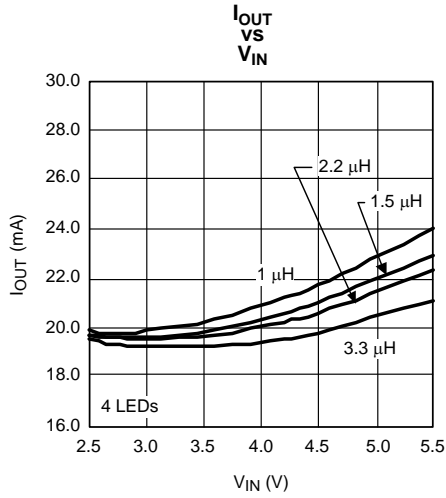

**Typical Performance Characteristics (continued)**

(See Figure 1:  $V_{IN} = 3.6V$ ,  $C_{IN} = 4.7\mu F$  and  $C_{OUT} = 1\mu F$ ,  $L = 2.2\mu H$  and 4 LEDs.  $T_A = +25^\circ C$ , unless otherwise stated.)

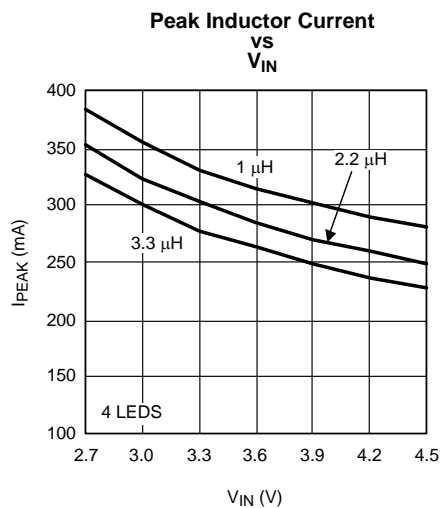
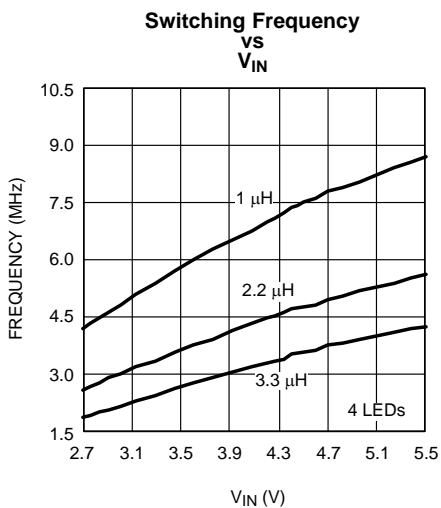
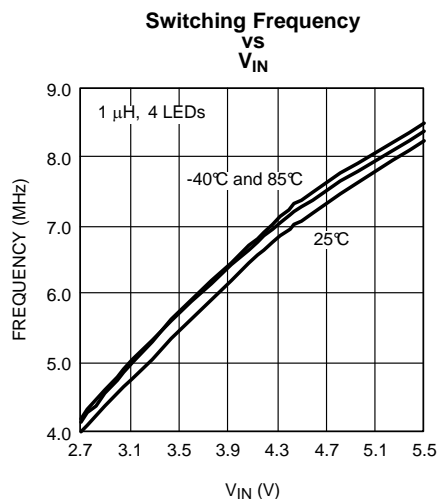
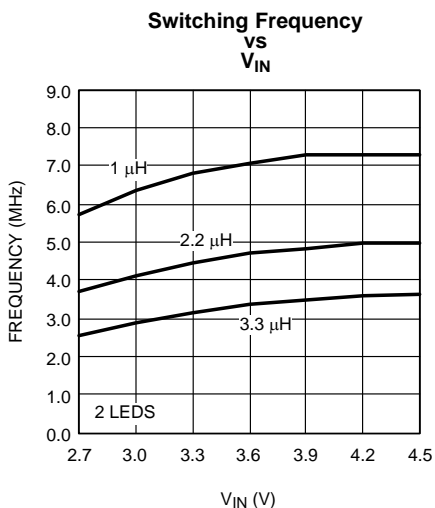
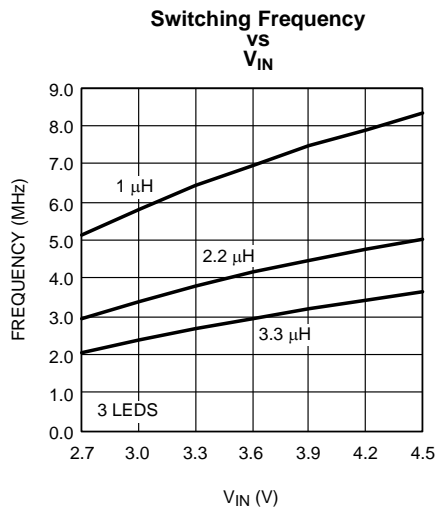
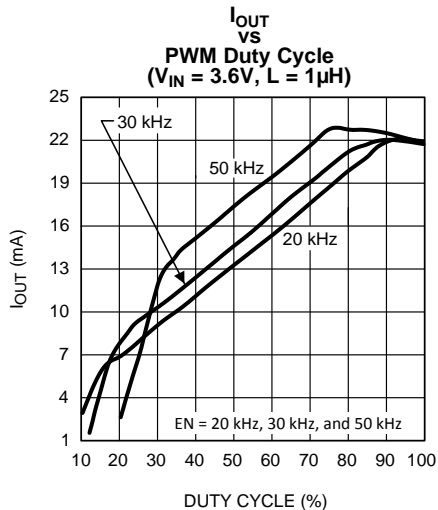

**Typical Performance Characteristics (continued)**

(See Figure 1:  $V_{IN} = 3.6V$ ,  $C_{IN} = 4.7\mu F$  and  $C_{OUT} = 1\mu F$ ,  $L = 2.2\mu H$  and 4 LEDs.  $T_A = +25^\circ C$ , unless otherwise stated.)

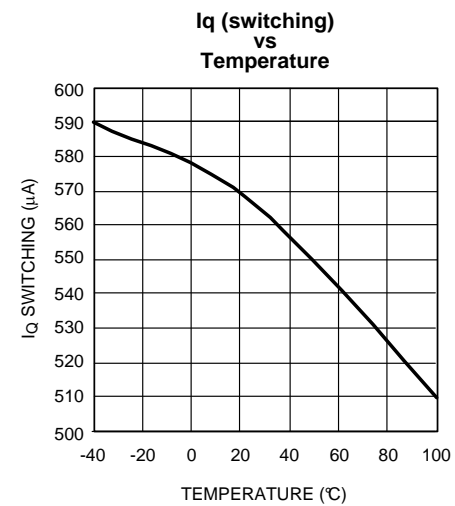
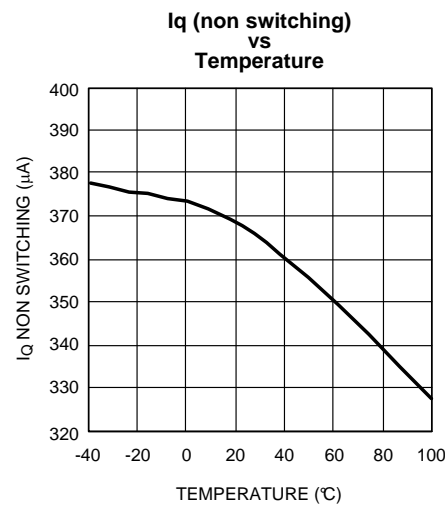
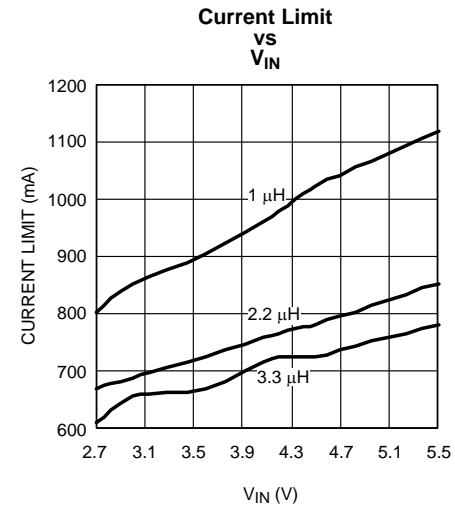
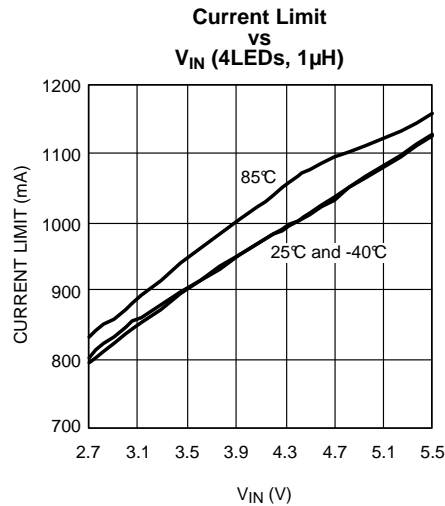
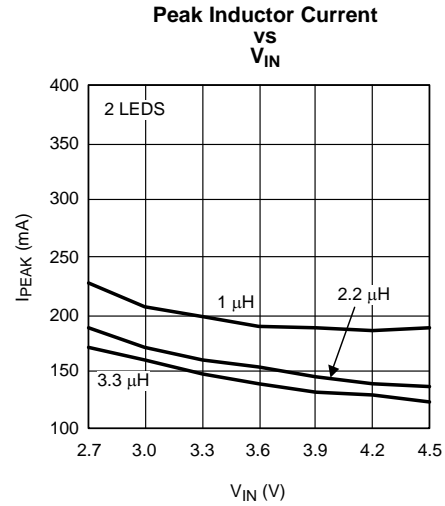
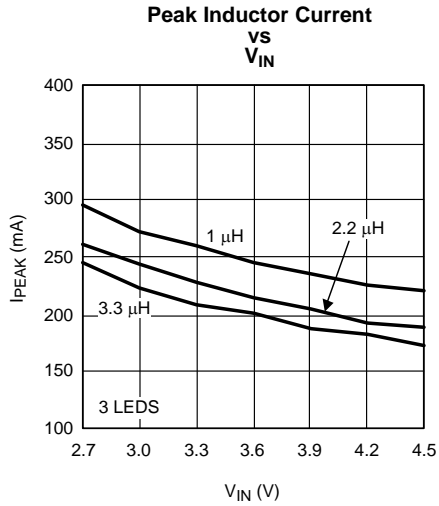

**Typical Performance Characteristics (continued)**

(See Figure 1:  $V_{IN} = 3.6V$ ,  $C_{IN} = 4.7\mu F$  and  $C_{OUT} = 1\mu F$ ,  $L = 2.2\mu H$  and 4 LEDs.  $T_A = +25^\circ C$ , unless otherwise stated.)

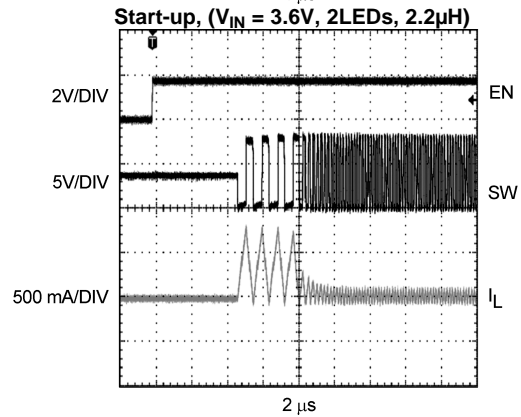
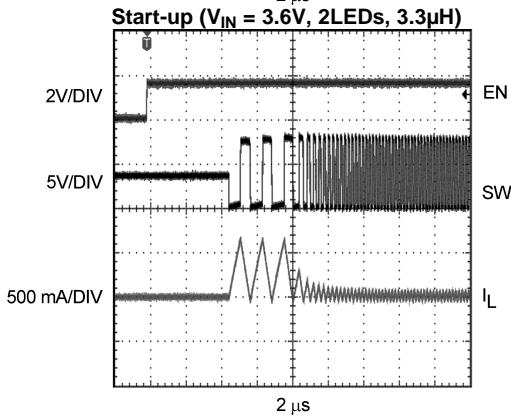
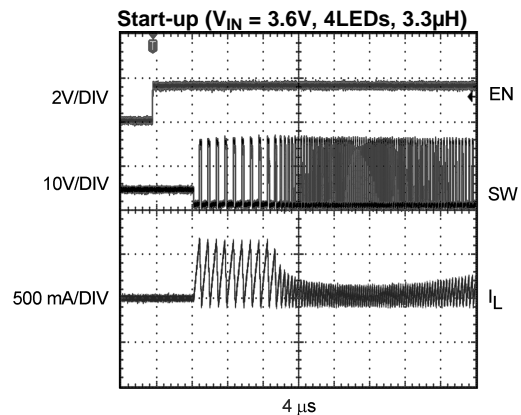
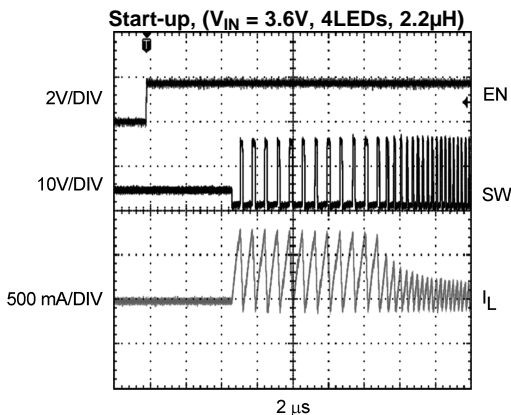
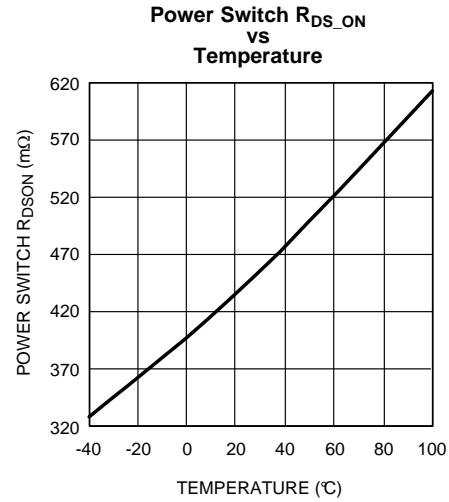
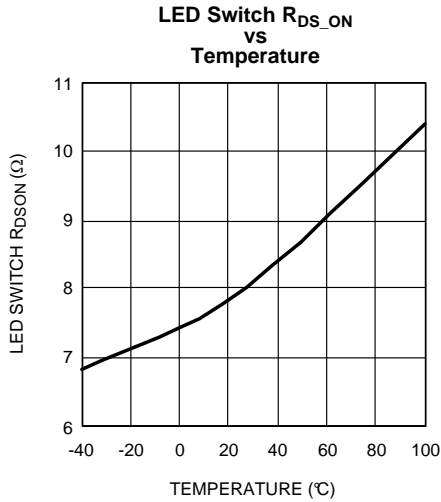

### Typical Performance Characteristics (continued)

(See Figure 1:  $V_{IN} = 3.6V$ ,  $C_{IN} = 4.7\mu F$  and  $C_{OUT} = 1\mu F$ ,  $L = 2.2\mu H$  and 4 LEDs.  $T_A = +25^\circ C$ , unless otherwise stated.)

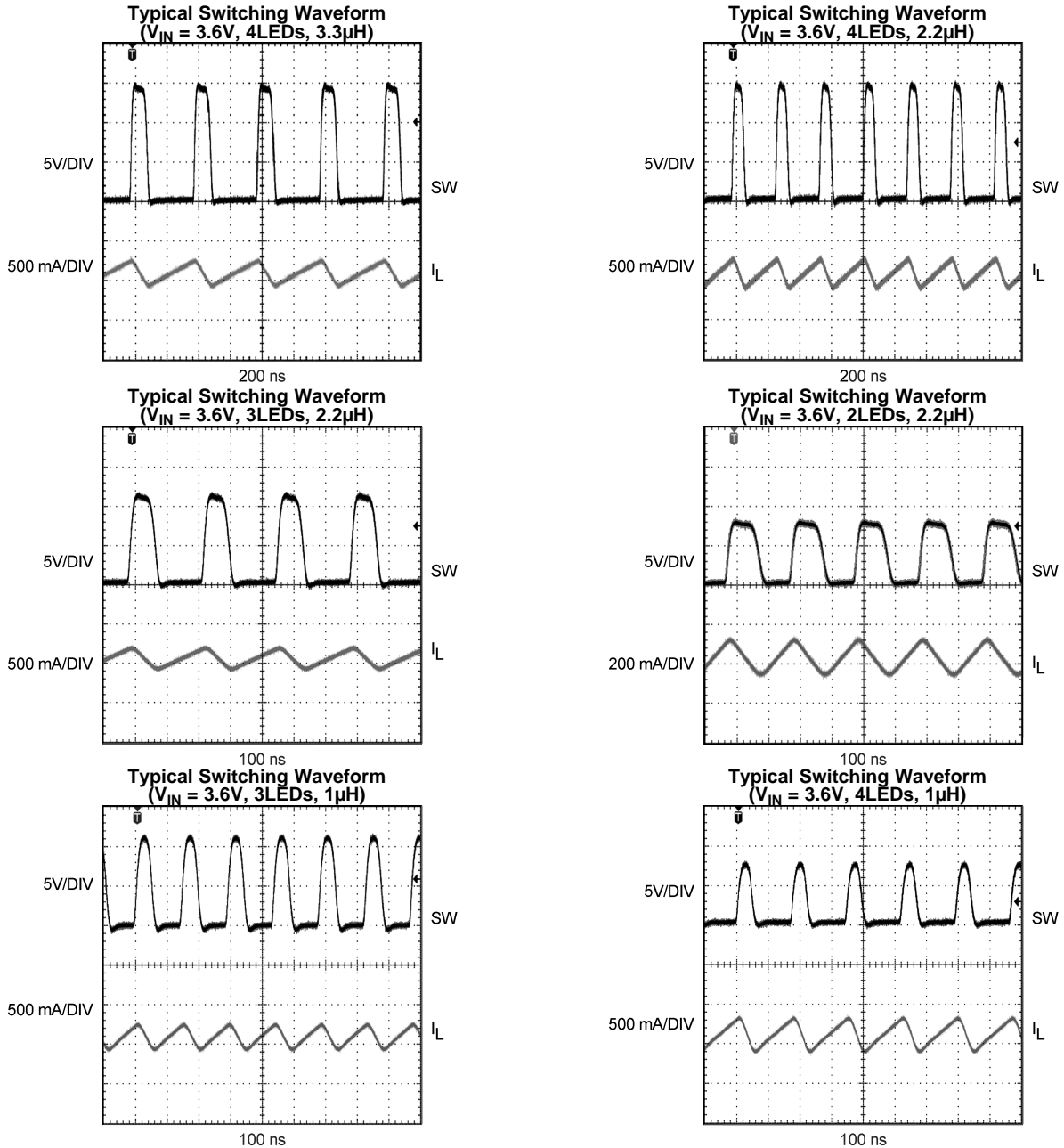

## APPLICATION INFORMATION

### Capacitor Selection

To minimize output and input voltage ripple, low equivalent series resistance (ESR) ceramic capacitors are the best choice to use for the input and output filters. For most display applications, a 4.7 $\mu$ F capacitor is recommended for  $C_{IN}$  and 1 $\mu$ F for  $C_{OUT}$ .

Larger output capacitors can be used to reduce ripple voltage. To ensure good performance, a minimum of 0.47 $\mu$ F  $C_{OUT}$  is required to trade off for large ripple voltage. Care must be taken to account for the true capacitance of a multilayer ceramic capacitor. Smaller case size capacitors typically have less capacitance for a given bias voltage as compared to a larger case size capacitor with the same bias voltage. Please confirm with capacitor manufacturer data before selecting the capacitor.

Recommended capacitor manufacturers include but are not limited to:

**Table 1.**

Manufacturer	Description	Case Size
AVX	06033D105MAT-25V	0603
	06036D475MAT-6.3V	0603
TDK	C2012X5R1A475M-10V	0805
Taiyo Yuden	TMK212BJ105KG-J	0805
	EM212BJ475MG-16V	0805
muRata	GRM40-034B105K25	0805
	GRM39X5R475K6.3	0603

### Inductor Selection

In order to maintain sufficient inductance, the saturation current rating of the inductor used with the LM3519 should be higher than the peak inductor current in the target application. Inductors with low DCR values have less power loss and higher efficiency. Larger inductor values such as 2.2 $\mu$ H and 3.3 $\mu$ H can be used to optimize efficiency, frequency and peak current. If 1 $\mu$ H is used, the peak inductor current, frequency will be higher and the efficiency will be lower. Note that the switching frequency ranges will be higher at lower inductance. Typical frequency range is between 4 to 8MHz for 1 $\mu$ H, 2 to 5MHz for 2.2 $\mu$ H and 2 to 4MHz for 3.3 $\mu$ H over the input range. Below is a sample list of low profile inductors.

Some recommended inductor manufacturers include but are not limited to:

Manufacturer	L	Case Size	I <sub>SAT</sub>
CoilCraft: DO3314-102	1 $\mu$ H	3.3x3.3x1.4mm	2.1A
	2.2 $\mu$ H		1.6A
	3.3 $\mu$ H		1.4A
Coilcraft: LPO3310-102ML	1 $\mu$ H	3.3x3.3x1.0 mm	1.6A
	2.2 $\mu$ H		1.1A
	3.3 $\mu$ H		0.95A
Cooper: SD31121R0	1 $\mu$ H	3.1x3.1x1.4 mm	2.07A
	2.2 $\mu$ H		1.48A
	3.3 $\mu$ H		1.15A
Taiyo Yuden: NR3015T1R0N	1 $\mu$ H	3.0x3.0x1.5 mm	2.1A
	2.2 $\mu$ H		1.48A
	3.3 $\mu$ H		1.21A

## Diode Selection

Diodes with low forward voltage ratings ( $V_F$ ) and low junction capacitance magnitudes ( $C_J$  or  $C_T$  or  $C_D$ ) are conducive to high efficiency. The chosen diode must have a reverse breakdown voltage rating ( $V_R$  and/or  $V_{RRM}$ ) that is larger than the output voltage. The following criteria should be followed when choosing a diode:

1.  $V_R$  (Diode Blocking Voltage Range) and  $V_{RRM}$  (Diode Peak Repetitive Reverse Voltage Rating)  $> V_{OUT}$  (Output Voltage)
2.  $I_F$  or  $I_O$  (Diode Average Forward Current Rating)  $\geq I_{LOAD}$  (Load Current)
3.  $I_{FRM}$  (Diode Peak Repetitive Forward Current Rating)  $\geq I_{Lpeak}$  (Peak Inductor Current)

Some recommended diode manufacturers include but are not limited to:

Manufacturer	Description
Vishay	SS12(1A/20V)
	SS14(1A/40V)
	SS16(1A/60V)
Central Semiconductor	CMSH1- 40M(1A/40V)
ONSem	MBRS1540T3(1.5A/40V)

## PWM DIMMING

The LED current is set internally by the LM3519 to 20mA (typical); dimming control may be realized by applying a pulse width modulated(PWM) signal to the En pin. For example, a 50% duty cycle waveform will produce an average current of 10mA. A control signal frequency between 17kHz and 30kHz is suitable for dimming.

Although the LM3519 is capable of operation outside this frequency range, it is not recommended to operate below 17kHz for the following reasons: 1) frequency below 100Hz is likely to cause visible flicker in the light emitted by the LED string, 2) frequency below 17kHz may induce audible noise due to combinations of some capacitance/PCB. A PWM frequency above 30kHz is possible but the current linearity vs duty cycle will be affected.

If it is not possible to operate the dimming control above 17kHz, audible noise emission may be minimized by using capacitors with low susceptibility to piezoelectric induced stresses, such as poly film designs. Minimum audible noise is most likely to occur when the PWM frequency is less than 2kHz. It is recommended that any application using a PWM control signal below 17kHz be thoroughly evaluated for undesirable audible or visible noise.

## DRIVING 2 LEDs

The LM3519 is optimized to drive up to 4LEDs. When driving 2LEDs, a minimum inductance of 2.2 $\mu$ H is required to maintain good loop regulation and current accuracy. If a smaller inductor is used, the LED current will have more variation with input voltage than a typical application. The following curve illustrates the behavior.

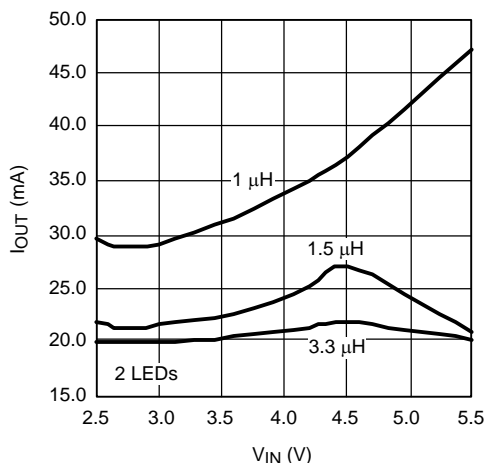

Figure 3. I<sub>OUT</sub> vs V<sub>IN</sub>

## LAYOUT GUIDELINES

The input capacitor, C<sub>IN</sub>, must be placed close to the LM3519. Placing C<sub>IN</sub> close to the device will reduce the metal trace resistance effect on input voltage ripple. Metal trace connections for the C<sub>OUT</sub> capacitor can increase the effective series resistance, which affects output voltage ripple and efficiency. Trace connections to the inductor should be short and wide to reduce power dissipation, increase overall efficiency and reduce EMI radiation. The diode, like the inductor, should have trace connections that are short and wide to reduce power dissipation and increase overall efficiency. For more details regarding layout guidelines for switching regulators, refer to Application Note AN1149 [SNVA021](#).

## REVISION HISTORY

Changes from Revision A (May 2013) to Revision B	Page
• Changed layout of National Data Sheet to TI format .....	13

**PACKAGING INFORMATION**

Orderable Device	Status (1)	Package Type	Package Drawing	Pins	Package Qty	Eco Plan (2)	Lead/Ball Finish (6)	MSL Peak Temp (3)	Op Temp (°C)	Device Marking (4/5)	Samples
LM3519MK-20/NOPB	ACTIVE	SOT-23-THIN	DDC	6	1000	Green (RoHS & no Sb/Br)	CU SN	Level-1-260C-UNLIM	-40 to 85	D52B	<b>Samples</b>

(1) The marketing status values are defined as follows:

**ACTIVE:** Product device recommended for new designs.

**LIFEBUY:** TI has announced that the device will be discontinued, and a lifetime-buy period is in effect.

**NRND:** Not recommended for new designs. Device is in production to support existing customers, but TI does not recommend using this part in a new design.

**PREVIEW:** Device has been announced but is not in production. Samples may or may not be available.

**OBSOLETE:** TI has discontinued the production of the device.

(2) Eco Plan - The planned eco-friendly classification: Pb-Free (RoHS), Pb-Free (RoHS Exempt), or Green (RoHS & no Sb/Br) - please check <http://www.ti.com/productcontent> for the latest availability information and additional product content details.

**TBD:** The Pb-Free/Green conversion plan has not been defined.

**Pb-Free (RoHS):** TI's terms "Lead-Free" or "Pb-Free" mean semiconductor products that are compatible with the current RoHS requirements for all 6 substances, including the requirement that lead not exceed 0.1% by weight in homogeneous materials. Where designed to be soldered at high temperatures, TI Pb-Free products are suitable for use in specified lead-free processes.

**Pb-Free (RoHS Exempt):** This component has a RoHS exemption for either 1) lead-based flip-chip solder bumps used between the die and package, or 2) lead-based die adhesive used between the die and leadframe. The component is otherwise considered Pb-Free (RoHS compatible) as defined above.

**Green (RoHS & no Sb/Br):** TI defines "Green" to mean Pb-Free (RoHS compatible), and free of Bromine (Br) and Antimony (Sb) based flame retardants (Br or Sb do not exceed 0.1% by weight in homogeneous material)

(3) MSL, Peak Temp. - The Moisture Sensitivity Level rating according to the JEDEC industry standard classifications, and peak solder temperature.

(4) There may be additional marking, which relates to the logo, the lot trace code information, or the environmental category on the device.

(5) Multiple Device Markings will be inside parentheses. Only one Device Marking contained in parentheses and separated by a "~" will appear on a device. If a line is indented then it is a continuation of the previous line and the two combined represent the entire Device Marking for that device.

(6) Lead/Ball Finish - Orderable Devices may have multiple material finish options. Finish options are separated by a vertical ruled line. Lead/Ball Finish values may wrap to two lines if the finish value exceeds the maximum column width.

**Important Information and Disclaimer:** The information provided on this page represents TI's knowledge and belief as of the date that it is provided. TI bases its knowledge and belief on information provided by third parties, and makes no representation or warranty as to the accuracy of such information. Efforts are underway to better integrate information from third parties. TI has taken and continues to take reasonable steps to provide representative and accurate information but may not have conducted destructive testing or chemical analysis on incoming materials and chemicals. TI and TI suppliers consider certain information to be proprietary, and thus CAS numbers and other limited information may not be available for release.

In no event shall TI's liability arising out of such information exceed the total purchase price of the TI part(s) at issue in this document sold by TI to Customer on an annual basis.



## TAPE AND REEL INFORMATION



### QUADRANT ASSIGNMENTS FOR PIN 1 ORIENTATION IN TAPE



\*All dimensions are nominal

Device	Package Type	Package Drawing	Pins	SPQ	Reel Diameter (mm)	Reel Width W1 (mm)	A0 (mm)	B0 (mm)	K0 (mm)	P1 (mm)	W (mm)	Pin1 Quadrant
LM3519MK-20/NOPB	SOT-23-THIN	DDC	6	1000	178.0	8.4	3.2	3.2	1.4	4.0	8.0	Q3

TAPE AND REEL BOX DIMENSIONS



\*All dimensions are nominal

Device	Package Type	Package Drawing	Pins	SPQ	Length (mm)	Width (mm)	Height (mm)
LM3519MK-20/NOPB	SOT-23-THIN	DDC	6	1000	210.0	185.0	35.0

DDC (R-PDSO-G6)

PLASTIC SMALL-OUTLINE

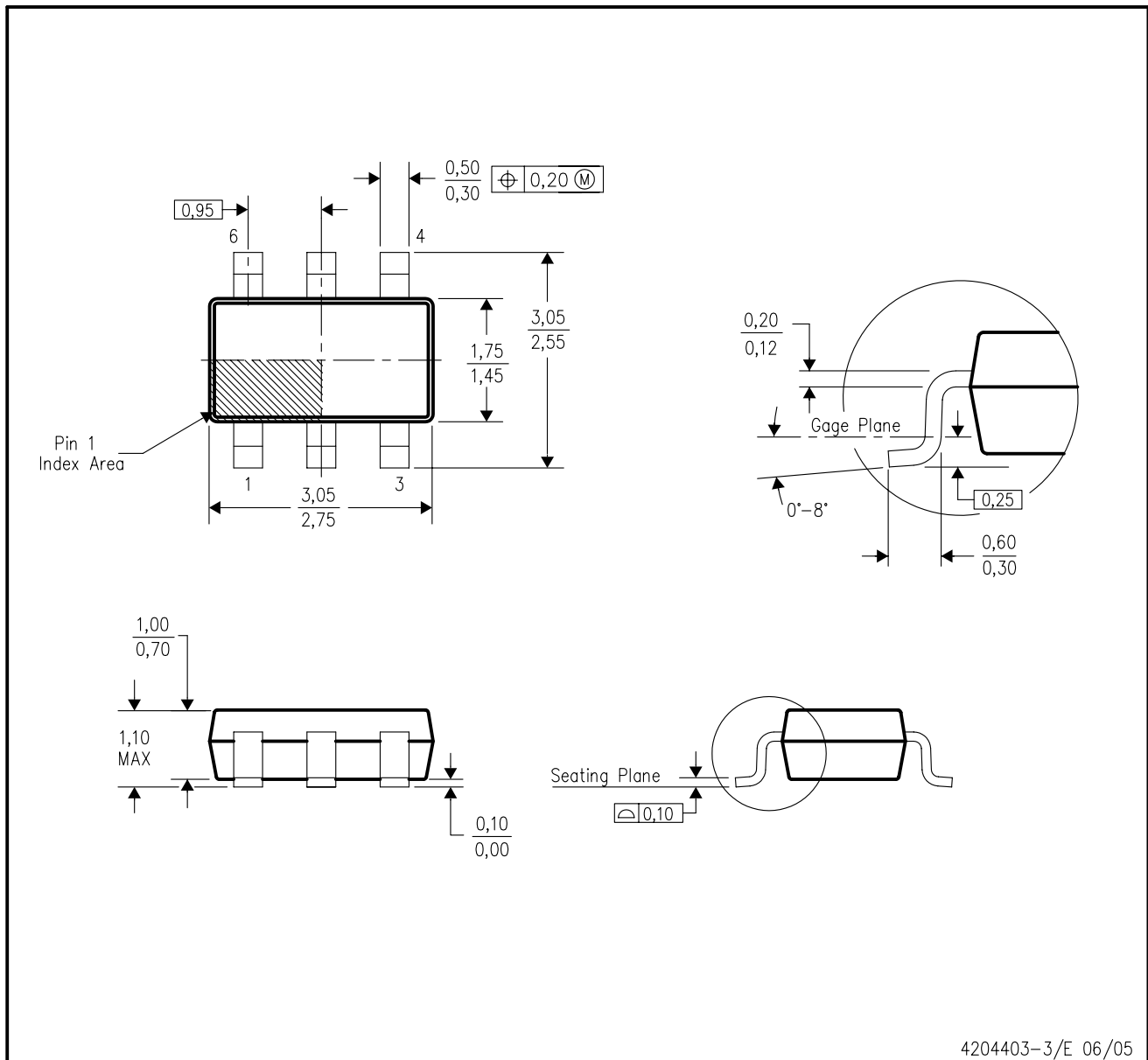

- NOTES:
- All linear dimensions are in millimeters.
  - This drawing is subject to change without notice.
  - Body dimensions do not include mold flash or protrusion.
  - Falls within JEDEC MO-193 variation AA (6 pin).

DDC (R-PDSO-G6)

PLASTIC SMALL OUTLINE

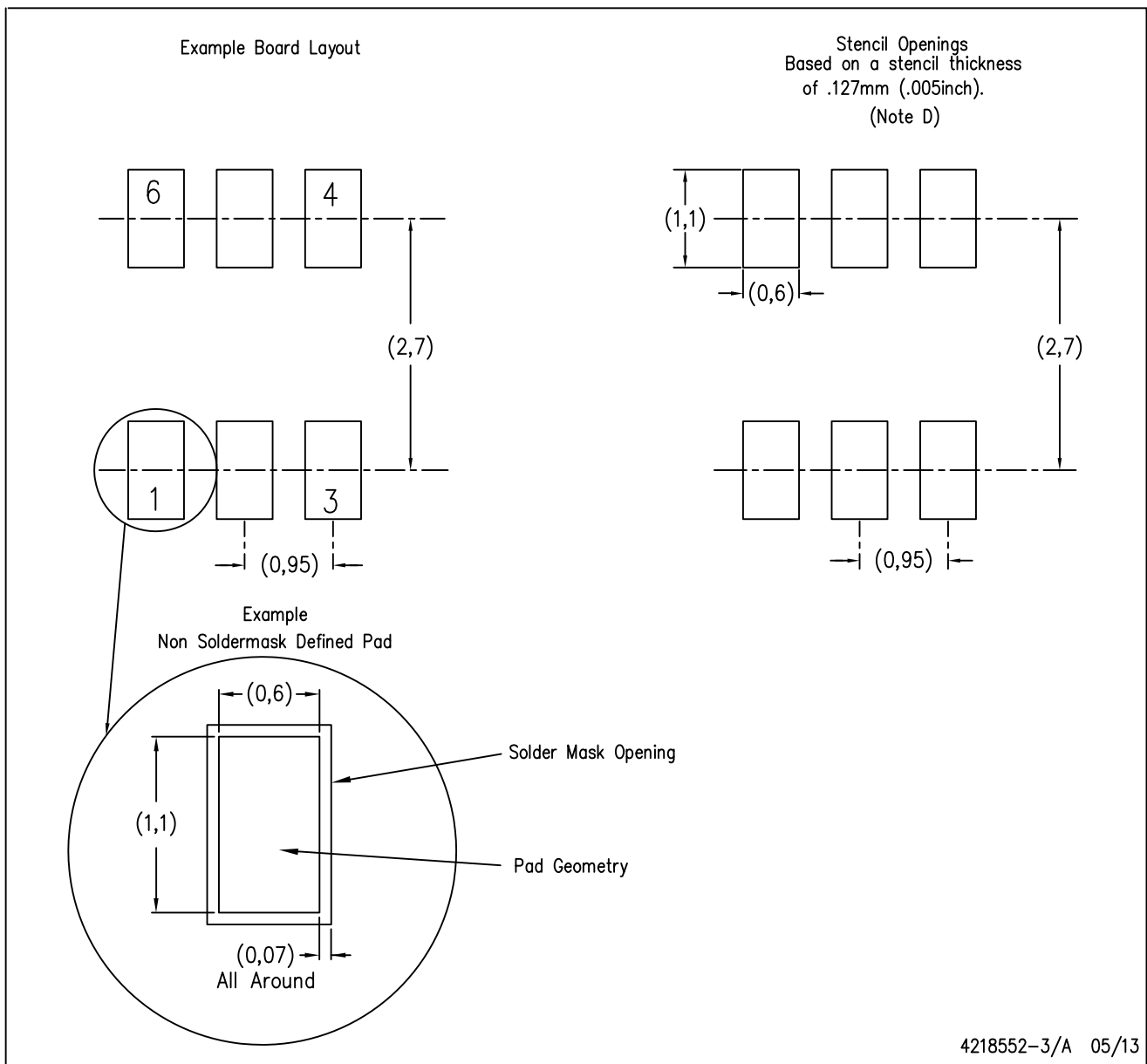

- NOTES:
- A. All linear dimensions are in millimeters.
  - B. This drawing is subject to change without notice.
  - C. Publication IPC-7351 is recommended for alternate designs.
  - D. Laser cutting apertures with trapezoidal walls and also rounding corners will offer better paste release. Customers should contact their board assembly site for stencil design recommendations. Example stencil design based on a 50% volumetric metal load solder paste. Refer to IPC-7525 for other stencil recommendations.

## IMPORTANT NOTICE

Texas Instruments Incorporated (TI) reserves the right to make corrections, enhancements, improvements and other changes to its semiconductor products and services per JESD46, latest issue, and to discontinue any product or service per JESD48, latest issue. Buyers should obtain the latest relevant information before placing orders and should verify that such information is current and complete.

TI's published terms of sale for semiconductor products (<http://www.ti.com/sc/docs/stdterms.htm>) apply to the sale of packaged integrated circuit products that TI has qualified and released to market. Additional terms may apply to the use or sale of other types of TI products and services.

Reproduction of significant portions of TI information in TI data sheets is permissible only if reproduction is without alteration and is accompanied by all associated warranties, conditions, limitations, and notices. TI is not responsible or liable for such reproduced documentation. Information of third parties may be subject to additional restrictions. Resale of TI products or services with statements different from or beyond the parameters stated by TI for that product or service voids all express and any implied warranties for the associated TI product or service and is an unfair and deceptive business practice. TI is not responsible or liable for any such statements.

Buyers and others who are developing systems that incorporate TI products (collectively, "Designers") understand and agree that Designers remain responsible for using their independent analysis, evaluation and judgment in designing their applications and that Designers have full and exclusive responsibility to assure the safety of Designers' applications and compliance of their applications (and of all TI products used in or for Designers' applications) with all applicable regulations, laws and other applicable requirements. Designer represents that, with respect to their applications, Designer has all the necessary expertise to create and implement safeguards that (1) anticipate dangerous consequences of failures, (2) monitor failures and their consequences, and (3) lessen the likelihood of failures that might cause harm and take appropriate actions. Designer agrees that prior to using or distributing any applications that include TI products, Designer will thoroughly test such applications and the functionality of such TI products as used in such applications.

TI's provision of technical, application or other design advice, quality characterization, reliability data or other services or information, including, but not limited to, reference designs and materials relating to evaluation modules, (collectively, "TI Resources") are intended to assist designers who are developing applications that incorporate TI products; by downloading, accessing or using TI Resources in any way, Designer (individually or, if Designer is acting on behalf of a company, Designer's company) agrees to use any particular TI Resource solely for this purpose and subject to the terms of this Notice.

TI's provision of TI Resources does not expand or otherwise alter TI's applicable published warranties or warranty disclaimers for TI products, and no additional obligations or liabilities arise from TI providing such TI Resources. TI reserves the right to make corrections, enhancements, improvements and other changes to its TI Resources. TI has not conducted any testing other than that specifically described in the published documentation for a particular TI Resource.

Designer is authorized to use, copy and modify any individual TI Resource only in connection with the development of applications that include the TI product(s) identified in such TI Resource. NO OTHER LICENSE, EXPRESS OR IMPLIED, BY ESTOPPEL OR OTHERWISE TO ANY OTHER TI INTELLECTUAL PROPERTY RIGHT, AND NO LICENSE TO ANY TECHNOLOGY OR INTELLECTUAL PROPERTY RIGHT OF TI OR ANY THIRD PARTY IS GRANTED HEREIN, including but not limited to any patent right, copyright, mask work right, or other intellectual property right relating to any combination, machine, or process in which TI products or services are used. Information regarding or referencing third-party products or services does not constitute a license to use such products or services, or a warranty or endorsement thereof. Use of TI Resources may require a license from a third party under the patents or other intellectual property of the third party, or a license from TI under the patents or other intellectual property of TI.

TI RESOURCES ARE PROVIDED "AS IS" AND WITH ALL FAULTS. TI DISCLAIMS ALL OTHER WARRANTIES OR REPRESENTATIONS, EXPRESS OR IMPLIED, REGARDING RESOURCES OR USE THEREOF, INCLUDING BUT NOT LIMITED TO ACCURACY OR COMPLETENESS, TITLE, ANY EPIDEMIC FAILURE WARRANTY AND ANY IMPLIED WARRANTIES OF MERCHANTABILITY, FITNESS FOR A PARTICULAR PURPOSE, AND NON-INFRINGEMENT OF ANY THIRD PARTY INTELLECTUAL PROPERTY RIGHTS. TI SHALL NOT BE LIABLE FOR AND SHALL NOT DEFEND OR INDEMNIFY DESIGNER AGAINST ANY CLAIM, INCLUDING BUT NOT LIMITED TO ANY INFRINGEMENT CLAIM THAT RELATES TO OR IS BASED ON ANY COMBINATION OF PRODUCTS EVEN IF DESCRIBED IN TI RESOURCES OR OTHERWISE. IN NO EVENT SHALL TI BE LIABLE FOR ANY ACTUAL, DIRECT, SPECIAL, COLLATERAL, INDIRECT, PUNITIVE, INCIDENTAL, CONSEQUENTIAL OR EXEMPLARY DAMAGES IN CONNECTION WITH OR ARISING OUT OF TI RESOURCES OR USE THEREOF, AND REGARDLESS OF WHETHER TI HAS BEEN ADVISED OF THE POSSIBILITY OF SUCH DAMAGES.

Unless TI has explicitly designated an individual product as meeting the requirements of a particular industry standard (e.g., ISO/TS 16949 and ISO 26262), TI is not responsible for any failure to meet such industry standard requirements.

Where TI specifically promotes products as facilitating functional safety or as compliant with industry functional safety standards, such products are intended to help enable customers to design and create their own applications that meet applicable functional safety standards and requirements. Using products in an application does not by itself establish any safety features in the application. Designers must ensure compliance with safety-related requirements and standards applicable to their applications. Designer may not use any TI products in life-critical medical equipment unless authorized officers of the parties have executed a special contract specifically governing such use. Life-critical medical equipment is medical equipment where failure of such equipment would cause serious bodily injury or death (e.g., life support, pacemakers, defibrillators, heart pumps, neurostimulators, and implantables). Such equipment includes, without limitation, all medical devices identified by the U.S. Food and Drug Administration as Class III devices and equivalent classifications outside the U.S.

TI may expressly designate certain products as completing a particular qualification (e.g., Q100, Military Grade, or Enhanced Product). Designers agree that it has the necessary expertise to select the product with the appropriate qualification designation for their applications and that proper product selection is at Designers' own risk. Designers are solely responsible for compliance with all legal and regulatory requirements in connection with such selection.

Designer will fully indemnify TI and its representatives against any damages, costs, losses, and/or liabilities arising out of Designer's non-compliance with the terms and provisions of this Notice.

## Looking for pricing, stock, or lifecycle information?

Click below to explore more details on WIN SOURCE:

 [View LM3519MK-20/NOPB on WIN SOURCE](#)

 [Texas Instruments](#) Information

## Optimize Your Supply Chain with WIN SOURCE Solutions

-  Global Sourcing Solution
-  Obsolete Management
-  Cost Control Management
-  Shortage Management
-  Alternative Solution
-  Excess Inventory Management