



**THE DATASHEET OF
LTC2051HVHS8#PBF**



FEATURES

- Maximum Offset Voltage of 3 μ V
- Maximum Offset Voltage Drift of 30nV/ $^{\circ}$ C
- Small Footprint, Low Profile MS8/GN16 Packages
- Single Supply Operation: 2.7V to \pm 5.5V
- Noise: 1.5 μ V_{P-P} (0.01Hz to 10Hz Typ)
- Voltage Gain: 140dB (Typ)
- PSRR: 130dB (Typ)
- CMRR: 130dB (Typ)
- Supply Current: 0.75mA (Typ) per Amplifier
- Extended Common Mode Input Range
- Output Swings Rail-to-Rail
- Operating Temperature Range –40 $^{\circ}$ C to 125 $^{\circ}$ C
- Available in 3mm \times 3mm \times 0.8mm DFN Package

APPLICATIONS

- Thermocouple Amplifiers
- Electronic Scales
- Medical Instrumentation
- Strain Gauge Amplifiers
- High Resolution Data Acquisition
- DC Accurate RC Active Filters
- Low Side Current Sense

DESCRIPTION

The LTC[®]2051/LTC2052 are dual/quad zero-drift operational amplifiers available in the MS8 and SO-8/GN16 and S14 packages. For space limited applications, the LTC2051 is available in a 3mm \times 3mm \times 0.8mm dual fine pitch leadless package (DFN). They operate from a single 2.7V supply and support \pm 5V applications. The current consumption is 750 μ A per op amp.

The LTC2051/LTC2052, despite their miniature size, feature uncompromising DC performance. The typical input offset voltage and offset drift are 0.5 μ V and 10nV/ $^{\circ}$ C. The almost zero DC offset and drift are supported with a power supply rejection ratio (PSRR) and common mode rejection ratio (CMRR) of more than 130dB.

The input common mode voltage ranges from the negative supply up to typically 1V from the positive supply. The LTC2051/LTC2052 also have an enhanced output stage capable of driving loads as low as 2k Ω to both supply rails. The open-loop gain is typically 140dB. The LTC2051/LTC2052 also feature a 1.5 μ V_{P-P} DC to 10Hz noise and a 3MHz gain-bandwidth product.

LT, LTC and LTM are registered trademarks of Linear Technology Corporation. All other trademarks are the property of their respective owners.

TYPICAL APPLICATION

High Performance Low Cost Instrumentation Amplifier



Input Referred Noise 0.1Hz to 10Hz



LTC2051/LTC2052

ABSOLUTE MAXIMUM RATINGS (Note 1)

| | | |
|---|--|----------------|
| Total Supply Voltage (V^+ to V^-) | Operating Temperature Range | -40°C to 125°C |
| LTC2051/LTC2052 | Specified Temperature Range (Note 3) | -40°C to 125°C |
| LTC2051HV/LTC2052HV | Storage Temperature Range | -65°C to 150°C |
| Input Voltage (Note 5) | DD Package | -65°C to 125°C |
| Output Short-Circuit Duration | Lead Temperature (Soldering, 10 sec) | 300°C |

PACKAGE/ORDER INFORMATION

|  <p>DD PACKAGE 8-LEAD (3mm × 3mm) PLASTIC DFN $T_{JMAX} = 125^{\circ}C, \theta_{JA} = 160^{\circ}C/W$ EXPOSED PAD (PIN 9) IS CONNECTED TO V^- (PIN 4)</p> | |  <p>MS8 PACKAGE 8-LEAD PLASTIC MSOP $T_{JMAX} = 125^{\circ}C, \theta_{JA} = 250^{\circ}C/W$</p> | |  <p>MS10 PACKAGE 10-LEAD PLASTIC MSOP $T_{JMAX} = 125^{\circ}C, \theta_{JA} = 250^{\circ}C/W$</p> | |
|--|------------------|---|--|---|------------------------------|
| ORDER PART NUMBER* | DD PART MARKING | ORDER PART NUMBER | MS8 PART MARKING | ORDER PART NUMBER | MS10 PART MARKING |
| LTC2051CDD LTC2051IDD LTC2051HVCDD LTC2051HVIDD | LAAN LAEL | LTC2051CMS8 LTC2051IMS8 LTC2051HVCMS8 LTC2051HVIMS8 LTC2051HMS8 LTC2051HVHMS8 | LTMN LTMP LTPJ LTPK LTVF LTVH | LTC2051CMS10 LTC2051IMS10 LTC2051HVCMS10 LTC2051HVIMS10 | LTMQ LTMR LTRB LTRC |
|  <p>S8 PACKAGE 8-LEAD PLASTIC SO $T_{JMAX} = 125^{\circ}C, \theta_{JA} = 190^{\circ}C/W$</p> | | | ORDER PART NUMBER | S8 PART MARKING | |
| | | | LTC2051CS8 LTC2051IS8 LTC2051HVCS8 LTC2051HVIS8 LTC2051HS8 LTC2051HVHS8 | 2051 2051I 2051HV 051HVI 2051H 051HVH | |
| Order Options Tape and Reel: Add #TR Lead Free: Add #PBF Lead Free Tape and Reel: Add #TRPBF Lead Free Part Marking: http://www.linear.com/leadfree/ | | | | | |

Consult LTC Marketing for parts specified with wider operating temperature ranges.

PACKAGE/ORDER INFORMATION

|  <p>GN PACKAGE 16-LEAD PLASTIC SSOP $T_{JMAX} = 125^{\circ}\text{C}$, $\theta_{JA} = 110^{\circ}\text{C/W}$</p> | <p>ORDER PART NUMBER</p> <p>LTC2052CGN LTC2052IGN LTC2052HVCGN LTC2052HVIGN LTC2052HGN LTC2052HVHGN</p> <p>GN PART MARKING</p> <p>2052 2052I 2052HV 052HVI 2052H 052HVH</p> |  <p>S PACKAGE 14-LEAD PLASTIC SO $T_{JMAX} = 125^{\circ}\text{C}$, $\theta_{JA} = 110^{\circ}\text{C/W}$</p> | <p>ORDER PART NUMBER</p> <p>LTC2052CS LTC2052IS LTC2052HVCS LTC2052HVIS LTC2052HS LTC2052HVHS</p> |
|--|---|--|---|
| | | | |

AVAILABLE OPTIONS

| PART NUMBER | AMPS/PACKAGE | SPECIFIED TEMP RANGE | SPECIFIED VOLTAGE | PACKAGE |
|----------------|--------------|----------------------|-------------------|--------------|
| LTC2051CDD | 2 | 0°C to 70°C | 3V, 5V | DD |
| LTC2051CS8 | 2 | 0°C to 70°C | 3V, 5V | SO-8 |
| LTC2051CMS8 | 2 | 0°C to 70°C | 3V, 5V | 8-Lead MSOP |
| LTC2051CMS10 | 2 | 0°C to 70°C | 3V, 5V | 10-Lead MSOP |
| LTC2051HVCDD | 2 | 0°C to 70°C | 3V, 5V, ±5V | DD |
| LTC2051HVCS8 | 2 | 0°C to 70°C | 3V, 5V, ±5V | SO-8 |
| LTC2051HVCMS8 | 2 | 0°C to 70°C | 3V, 5V, ±5V | 8-Lead MSOP |
| LTC2051HVCMS10 | 2 | 0°C to 70°C | 3V, 5V, ±5V | 10-Lead MSOP |
| LTC2051IDD | 2 | -40°C to 85°C | 3V, 5V | DD |
| LTC2051IS8 | 2 | -40°C to 85°C | 3V, 5V | SO-8 |
| LTC2051IMS8 | 2 | -40°C to 85°C | 3V, 5V | 8-Lead MSOP |
| LTC2051IMS10 | 2 | -40°C to 85°C | 3V, 5V | 10-Lead MSOP |
| LTC2051HVIDD | 2 | -40°C to 85°C | 3V, 5V, ±5V | DD |
| LTC2051HVIS8 | 2 | -40°C to 85°C | 3V, 5V, ±5V | SO-8 |
| LTC2051HVIMS8 | 2 | -40°C to 85°C | 3V, 5V, ±5V | 8-Lead MSOP |
| LTC2051HVIMS10 | 2 | -40°C to 85°C | 3V, 5V, ±5V | 10-Lead MSOP |
| LTC2051HS8 | 2 | -40°C to 125°C | 3V, 5V | SO-8 |
| LTC2051HMS8 | 2 | -40°C to 125°C | 3V, 5V | 8-Lead MSOP |
| LTC2051HVHS8 | 2 | -40°C to 125°C | 3V, 5V, ±5V | SO-8 |
| LTC2051HVHMS8 | 2 | -40°C to 125°C | 3V, 5V, ±5V | 8-Lead MSOP |
| LTC2052CS | 4 | 0°C to 70°C | 3V, 5V | 14-Lead SO |
| LTC2052CGN | 4 | 0°C to 70°C | 3V, 5V | 16-Lead SSOP |
| LTC2052HVCS | 4 | 0°C to 70°C | 3V, 5V, ±5V | 14-Lead SO |
| LTC2052HVCGN | 4 | 0°C to 70°C | 3V, 5V, ±5V | 16-Lead SSOP |

AVAILABLE OPTIONS

| PART NUMBER | AMPS/PACKAGE | SPECIFIED TEMP RANGE | SPECIFIED VOLTAGE | PACKAGE |
|--------------|--------------|----------------------|-------------------|--------------|
| LTC2052IS | 4 | -40°C to 85°C | 3V, 5V | 14-Lead SO |
| LTC2052IGN | 4 | -40°C to 85°C | 3V, 5V | 16-Lead SSOP |
| LTC2052HVIS | 4 | -40°C to 85°C | 3V, 5V, ±5V | 14-Lead SO |
| LTC2052HVIGN | 4 | -40°C to 85°C | 3V, 5V, ±5V | 16-Lead SSOP |
| LTC2052HS | 4 | -40°C to 125°C | 3V, 5V | 14-Lead SO |
| LTC2052HGN | 4 | -40°C to 125°C | 3V, 5V | 16-Lead SSOP |
| LTC2052HVHS | 4 | -40°C to 125°C | 3V, 5V, ±5V | 14-Lead SO |
| LTC2052HVHGN | 4 | -40°C to 125°C | 3V, 5V, ±5V | 16-Lead SSOP |

ELECTRICAL CHARACTERISTICS

(LTC2051/LTC2052, LTC2051HV/LTC2052HV) The ● denotes the specifications which apply over the full operating temperature range, otherwise specifications are at $T_A = 25^\circ\text{C}$. $V_S = 3\text{V}, 5\text{V}$ unless otherwise noted. (Note 3)

| PARAMETER | CONDITIONS | LTC2051C/LTC2052C LTC2051I/LTC2052I | | | LTC2051H/LTC2052H | | | UNITS |
|--------------------------------|--|--|--------------|--------------|-------------------|--------------|-----|-------------------|
| | | MIN | TYP | MAX | MIN | TYP | MAX | |
| Input Offset Voltage | (Note 2) | | ±0.5 | ±3 | ±0.5 | ±3 | | μV |
| Average Input Offset Drift | (Note 2) | ● | 0.01 | ±0.03 | 0.01 | ±0.05 | | μV/°C |
| Long-Term Offset Drift | | | 50 | | 50 | | | nV/√mo |
| Input Bias Current (Note 4) | $V_S = 3\text{V}$ | | ±8 | ±50 | ±8 | ±50 | | pA |
| | $V_S = 3\text{V}$ | ● | | ±100 | | ±3000 | | pA |
| Input Offset Current (Note 4) | $V_S = 5\text{V}$ | | ±25 | ±75 | ±25 | ±75 | | pA |
| | $V_S = 5\text{V}$ | ● | | ±150 | | ±3000 | | pA |
| Input Offset Current (Note 4) | $V_S = 3\text{V}$ | | | ±100 | | ±100 | | pA |
| | $V_S = 3\text{V}$ | ● | | ±150 | | ±700 | | pA |
| Input Offset Current (Note 4) | $V_S = 5\text{V}$ | | | ±150 | | ±150 | | pA |
| | $V_S = 5\text{V}$ | ● | | ±200 | | ±700 | | pA |
| Input Noise Voltage | $R_S = 100\Omega$, DC to 10Hz | | 1.5 | | 1.5 | | | μV _{p-p} |
| Common Mode Rejection Ratio | $V_{CM} = \text{GND to } V^+ - 1.3$, $V_S = 3\text{V}$ | ● | 115 | 130 | 115 | 130 | | dB |
| | $V_{CM} = \text{GND to } V^+ - 1.3$, $V_S = 3\text{V}$ | | 110 | 130 | 110 | 130 | | dB |
| Common Mode Rejection Ratio | $V_{CM} = \text{GND to } V^+ - 1.3$, $V_S = 5\text{V}$ | ● | 120 | 130 | 120 | 130 | | dB |
| | $V_{CM} = \text{GND to } V^+ - 1.3$, $V_S = 5\text{V}$ | | 115 | 130 | 115 | 130 | | dB |
| Power Supply Rejection Ratio | | ● | 120 | 130 | 120 | 130 | | dB |
| | | | 115 | 130 | 115 | 130 | | dB |
| Large-Signal Voltage Gain | $R_L = 10\text{k}$, $V_S = 3\text{V}$ | ● | 120 | 140 | 120 | 140 | | dB |
| | $R_L = 10\text{k}$, $V_S = 3\text{V}$ | | 115 | 140 | 115 | 140 | | dB |
| Large-Signal Voltage Gain | $R_L = 10\text{k}$, $V_S = 5\text{V}$ | ● | 125 | 140 | 125 | 140 | | dB |
| | $R_L = 10\text{k}$, $V_S = 5\text{V}$ | | 120 | 140 | 120 | 140 | | dB |
| Output Voltage Swing High | $R_L = 2\text{k to GND}$ | ● | $V^+ - 0.15$ | $V^+ - 0.06$ | $V^+ - 0.15$ | $V^+ - 0.06$ | | V |
| | $R_L = 10\text{k to GND}$ | ● | $V^+ - 0.05$ | $V^+ - 0.02$ | $V^+ - 0.05$ | $V^+ - 0.02$ | | V |
| Output Voltage Swing Low | $R_L = 2\text{k to GND}$ | ● | 2 | 15 | 2 | 15 | | mV |
| | $R_L = 10\text{k to GND}$ | ● | 2 | 15 | 2 | 15 | | mV |
| Slew Rate | | | 2 | | 2 | | | V/μs |
| Gain Bandwidth Product | | | 3 | | 3 | | | MHz |
| Supply Current (Per Amplifier) | No Load, $V_S = 3\text{V}$, $V_{SHDN} = V_{IH}$ | ● | 0.75 | 1.0 | 0.75 | 1.1 | | mA |
| | No Load, $V_S = 5\text{V}$, $V_{SHDN} = V_{IH}$ | ● | 0.85 | 1.2 | 0.85 | 1.3 | | mA |
| Supply Current, Shutdown | $V_{SHDN} = V_{IL}$, $V_S = 3\text{V}$ | ● | 2 | 5 | 2 | 5 | | μA |
| | $V_{SHDN} = V_{IL}$, $V_S = 5\text{V}$ | ● | 4 | 10 | 4 | 10 | | μA |

ELECTRICAL CHARACTERISTICS

(LTC2051/LTC2052, LTC2051HV/LTC2052HV) The ● denotes the specifications which apply over the full operating temperature range, otherwise specifications are at $T_A = 25^\circ\text{C}$. $V_S = 3\text{V}$, 5V unless otherwise noted. (Note 3)

| PARAMETER | CONDITIONS | LTC2051C/LTC2052C LTC2051I/LTC2052I | | | LTC2051H/LTC2052H | | | UNITS |
|--|--|--|-------------|-------------|-------------------|-----|-------------|---------------|
| | | MIN | TYP | MAX | MIN | TYP | MAX | |
| Shutdown Pin Input Low Voltage (V_{IL}) | | ● | | $V^- + 0.5$ | | | $V^- + 0.5$ | V |
| Shutdown Pin Input High Voltage (V_{IH}) | | ● | $V^+ - 0.5$ | | | | $V^+ - 0.5$ | V |
| Shutdown Pin Input Current | $V_{SHDN} = V_{IL}$, $V_S = 3\text{V}$ $V_{SHDN} = V_{IL}$, $V_S = 5\text{V}$ | ● | -1 | -3 | | -1 | -3 | μA |
| | | ● | -2 | -5 | | -2 | -5 | μA |
| Internal Sampling Frequency | | | 7.5 | | | 7.5 | | kHz |

(LTC2051HV/LTC2052HV) The ● denotes the specifications which apply over the full operating temperature range, otherwise specifications are at $T_A = 25^\circ\text{C}$. $V_S = \pm 5\text{V}$ unless otherwise noted. (Note 3)

| PARAMETER | CONDITIONS | LTC2051C/LTC2052C LTC2051I/LTC2052I | | | LTC2051H/LTC2052H | | | UNITS |
|--|---|--|-------------|------------------------|-------------------|-------------|-------------------------|------------------------------|
| | | MIN | TYP | MAX | MIN | TYP | MAX | |
| Input Offset Voltage | (Note 2) | | ± 1 | ± 3 | | ± 1 | ± 3 | μV |
| Average Input Offset Drift | (Note 2) | ● | 0.01 | ± 0.03 | | 0.01 | ± 0.05 | $\mu\text{V}/^\circ\text{C}$ |
| Long-Term Offset Drift | | | 50 | | | 50 | | $\text{nV}/\sqrt{\text{mo}}$ |
| Input Bias Current (Note 4) | | ● | ± 90 | ± 150 ± 300 | | ± 90 | ± 150 ± 3000 | pA pA |
| Input Offset Current (Note 4) | | ● | | ± 300 ± 500 | | | ± 300 ± 700 | pA pA |
| Input Noise Voltage | $R_S = 100\Omega$, DC to 10Hz | | 1.5 | | | 1.5 | | $\mu\text{V}_{\text{p-p}}$ |
| Common Mode Rejection Ratio | $V_{\text{CM}} = V^-$ to $V^+ - 1.3$ | ● | 125 | 130 | | 125 | 130 | dB |
| | | | 120 | 130 | | 120 | 130 | dB |
| Power Supply Rejection Ratio | | ● | 120 | 130 | | 120 | 130 | dB |
| | | | 115 | 130 | | 115 | 130 | dB |
| Large-Signal Voltage Gain | $R_L = 10\text{k}$ | ● | 125 | 140 | | 125 | 140 | dB |
| | | | 120 | 140 | | 120 | 140 | dB |
| Maximum Output Voltage Swing | $R_L = 2\text{k}$ to GND $R_L = 10\text{k}$ to GND | ● | ± 4.75 | ± 4.92 | | ± 4.50 | ± 4.92 | V |
| | | ● | ± 4.90 | ± 4.98 | | ± 4.85 | ± 4.98 | V |
| Slew Rate | | | 2 | | | 2 | | $\text{V}/\mu\text{s}$ |
| Gain Bandwidth Product | | | 3 | | | 3 | | MHz |
| Supply Current (Per Amplifier) | No Load, $V_{\text{SHDN}} = V_{\text{IH}}$ | ● | 1 | 1.5 | | 1 | 1.5 | mA |
| Supply Current, Shutdown | $V_{\text{SHDN}} = V_{\text{IL}}$ | ● | 15 | 30 | | 15 | 30 | μA |
| Shutdown Pin Input Low Voltage (V_{IL}) | | ● | | $V^- + 0.5$ | | | $V^- + 0.5$ | V |
| Shutdown Pin Input High Voltage (V_{IH}) | | ● | $V^+ - 0.5$ | | | $V^+ - 0.5$ | | V |
| Shutdown Pin Input Current | $V_{\text{SHDN}} = V_{\text{IL}}$ | ● | -7 | -15 | | -7 | -15 | μA |
| Internal Sampling Frequency | | | 7.5 | | | 7.5 | | kHz |

Note 1: Stresses beyond those listed under Absolute Maximum Ratings may cause permanent damage to the device. Exposure to any Absolute Maximum Rating condition for extended periods may affect device reliability and lifetime.

Note 2: These parameters are guaranteed by design. Thermocouple effects preclude measurements of these voltage levels during automated testing.

Note 3: All versions of the LTC2051/LTC2052 are designed, characterized and expected to meet the extended temperature limits of -40°C and 125°C . The LTC2051C/LTC2052C/LTC2051HVC/LTC2052HVC are guaranteed to meet the temperature limits of 0°C and 70°C . The LTC2051I/LTC2052I/LTC2051HVI/LTC2052HVI are guaranteed to meet temperature limits of -40°C and 85°C . The LTC2051H/LTC2051HVH and LTC2052H/LTC2052HVH

are guaranteed to meet the temperature limits of -40°C and 125°C .

Note 4: The bias current measurement accuracy depends on the proximity of the negative supply bypass capacitors to the device under test. Because of this, only the bias current of channel B (LTC2051) and channels A and B (LTC2052) are 100% tested to the data sheet specifications. The bias currents of the remaining channels are 100% tested to relaxed limits, however, their values are guaranteed by design to meet the data sheet limits.

Note 5: This parameter is guaranteed to meet specified performance through design and characterization. It has not been tested.

Note 6: The θ_{JA} specified for the DD package is with minimal PCB heat spreading metal. Using expanded metal area on all layers of a board reduces this value.

TYPICAL PERFORMANCE CHARACTERISTICS

Common Mode Rejection Ratio vs Frequency



20512 G01

DC CMRR vs Common Mode Input Range



20512 G02

PSRR vs Frequency

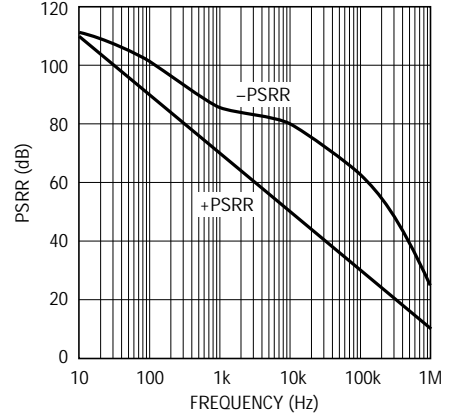

20512 G03

Output Voltage Swing vs Load Resistance

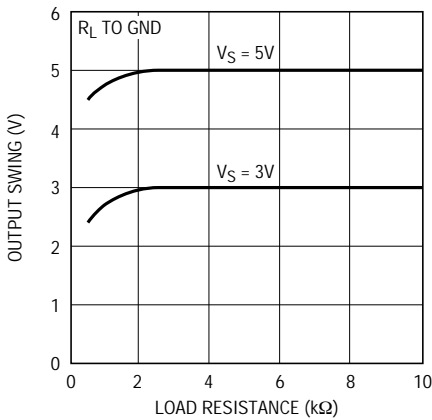

20512 G04

Output Swing vs Output Current

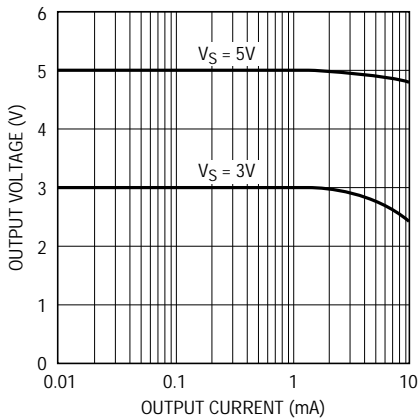

20512 G05

Output Swing vs Load Resistance ±5V

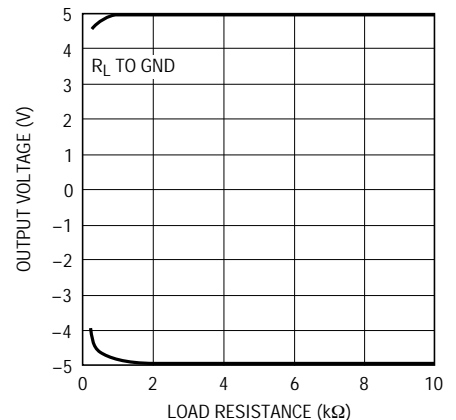

20512 G06

Output Swing vs Output Current, ±5V Supply

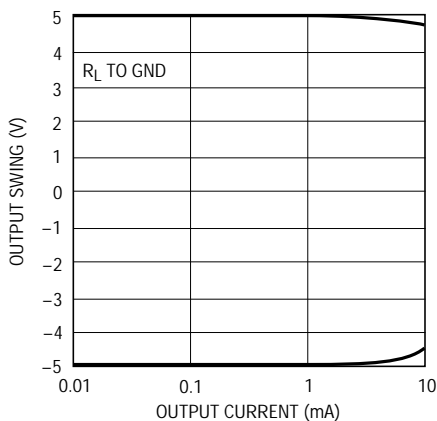

20512 G07

Gain/Phase vs Frequency

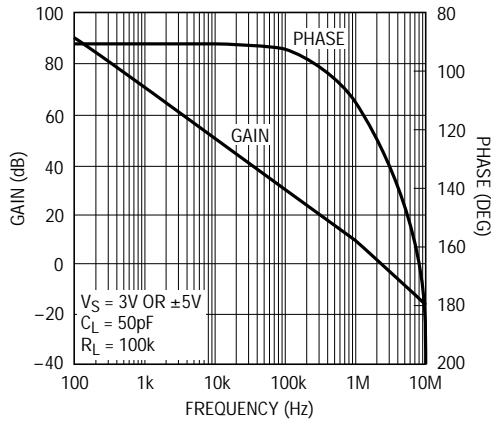

20512 G08

Bias Current vs Temperature

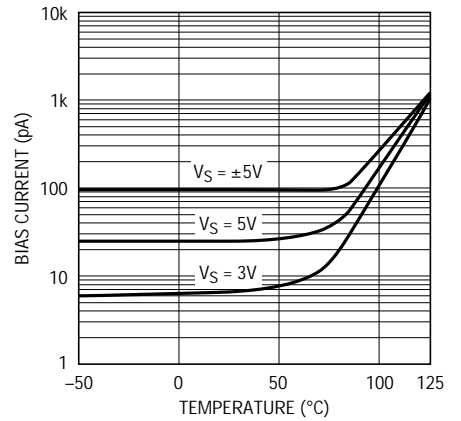

20512 G09

20512fd

TYPICAL PERFORMANCE CHARACTERISTICS

Input Bias Current vs Input Common Mode Voltage



Transient Response

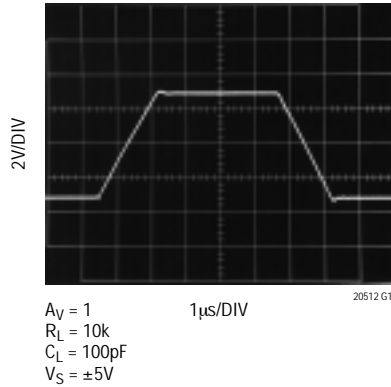

Input Overload Recovery

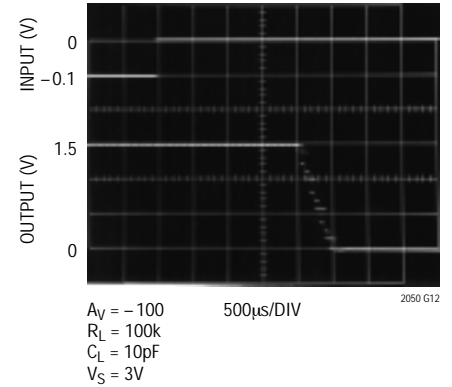

Sampling Frequency vs Supply Voltage

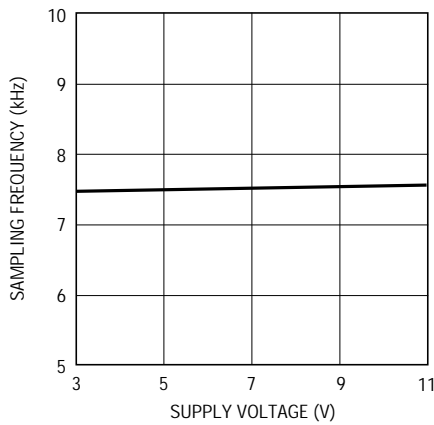

Sampling Frequency vs Temperature

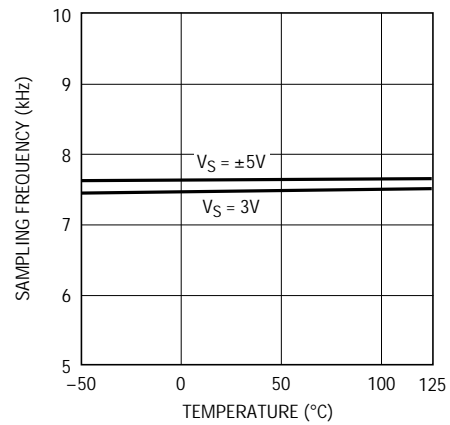

Supply Current (Per Amplifier) vs Supply Voltage



Supply Current (Per Amplifier) vs Temperature



APPLICATIONS INFORMATION

Shutdown

The LTC2051 includes a shutdown pin in the 10-lead MSOP. When this active low pin is high or allowed to float, the device operates normally. When the shutdown pin is pulled low, the device enters shutdown mode; supply current drops to 3 μ A, all clocking stops and the output assumes a high impedance state.

Clock Feedthrough, Input Bias Current

The LTC2051/LTC2052 use autozeroing circuitry to achieve an almost zero DC offset over temperature, common mode voltage and power supply voltage. The frequency of the clock used for autozeroing is typically 7.5kHz. The term clock feedthrough is broadly used to indicate visibility of this clock frequency in the op amp output spectrum. There are typically two types of clock feedthrough in autozeroed op amps like the LTC2051/LTC2052.

The first form of clock feedthrough is caused by the settling of the internal sampling capacitor and is input referred; that is, it is multiplied by the closed-loop gain of the op amp. This form of clock feedthrough is independent of the magnitude of the input source resistance or the magnitude of the gain setting resistors. The LTC2051/LTC2052 have a residue clock feedthrough of less than 1 μ V_{RMS} input referred at 7.5kHz.

The second form of clock feedthrough is caused by the small amount of charge injection occurring during the sampling and holding of the op amps input offset voltage. The current spikes are multiplied by the impedance seen at the input terminals of the op amp, appearing at the output multiplied by the closed-loop gain of the op amp.

To reduce this form of clock feedthrough, use smaller valued gain setting resistors and minimize the source resistance at the input. If the resistance seen at the inputs is less than 10k, this form of clock feedthrough is less than 1 μ V_{RMS} input referred at 7.5kHz, or less than the amount of residue clock feedthrough from the first form previously described.

Placing a capacitor across the feedback resistor reduces either form of clock feedthrough by limiting the bandwidth of the closed-loop gain.

Input bias current is defined as the DC current into the input pins of the op amp. The same current spikes that cause the second form of clock feedthrough previously described, when averaged, dominate the DC input bias current of the op amp below 70°C.

At temperatures above 70°C, the leakage of the ESD protection diodes on the inputs increase the input bias currents of both inputs in the positive direction, while the current caused by the charge injection stays relatively constant. At elevated temperatures (above 85°C) the leakage current begins to dominate and both the negative and positive pin's input bias currents are in the positive direction (into the pins).

Input Pins, ESD Sensitivity

ESD voltages above 700V on the input pins of the op amp will cause the input bias currents to increase (more DC current into the pins). At these voltages, it is possible to damage the device to a point where the input bias current exceeds the maximums specified in this data sheet.

TYPICAL APPLICATION

The dual chopper op amp buffers the inputs of A1 and corrects its offset voltage and offset voltage drift. With the RC values shown, the power-up warm-up time is typically 20 seconds. The step response of the composite amplifier does not present settling tails. The LT[®]1677 should be used when extremely low noise, V_{OS} and V_{OS} drift are

needed and the input source resistance is low. (For instance a 350 Ω strain gauge bridge.) The LT1012 or equivalent should be used when low bias current (100pA) is also required in conjunction with DC to 10Hz low noise, low V_{OS} and V_{OS} drift. The measured typical input offset voltages are less than 1 μ V.

TYPICAL APPLICATION

Obtaining Ultralow V_{OS} Drift and Low Noise

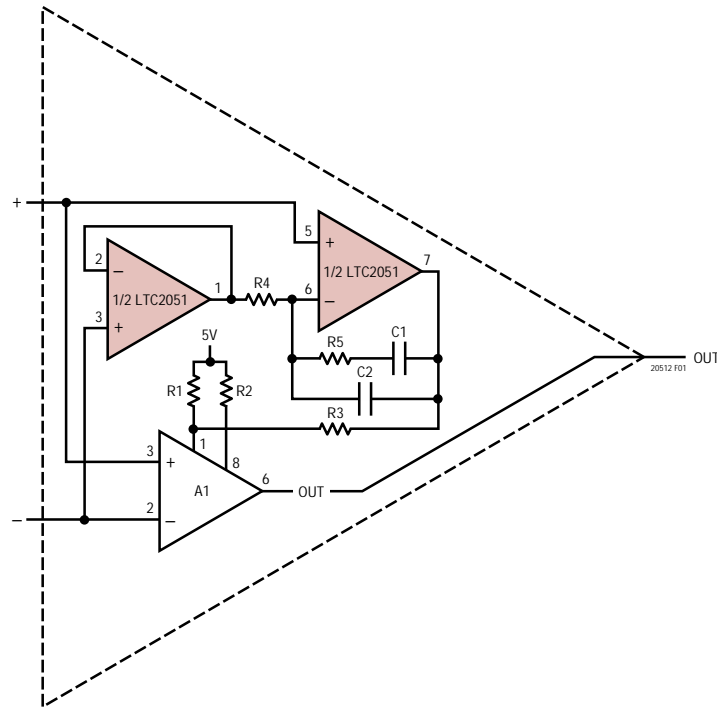

| A1 | R1 | R2 | R3 | R4 | R5 | C1 | C2 | \bar{e}_{IN} (DC - 1Hz) | \bar{e}_{IN} (DC - 10Hz) |
|--------|--------------|-------------|------|-----|------|--------------|---------------|-----------------------------|----------------------------|
| LT1677 | 2.49k | 3.01k | 340k | 10k | 100k | 0.01 μ F | 0.001 μ F | 0.15 μ V _{P-P} | 0.2 μ V _{P-P} |
| LT1012 | 750 Ω | 57 Ω | 250k | 10k | 100k | 0.01 μ F | 0.001 μ F | 0.3 μ V _{P-P} | 0.4 μ V _{P-P} |

PACKAGE DESCRIPTION

DD Package
8-Lead Plastic DFN (3mm x 3mm)
 (Reference LTC DWG # 05-08-1698)

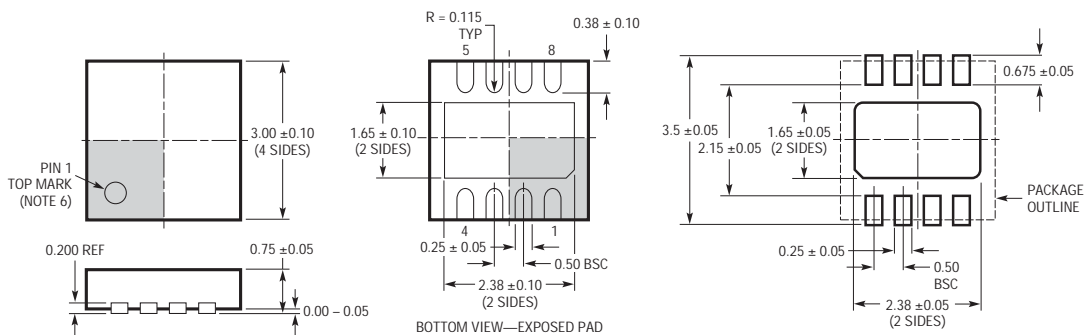

- NOTE:
1. DRAWING TO BE MADE A JEDEC PACKAGE OUTLINE MO-229 VARIATION OF (WEED-1)
 2. DRAWING NOT TO SCALE
 3. ALL DIMENSIONS ARE IN MILLIMETERS
 4. DIMENSIONS OF EXPOSED PAD ON BOTTOM OF PACKAGE DO NOT INCLUDE MOLD FLASH. MOLD FLASH, IF PRESENT, SHALL NOT EXCEED 0.15mm ON ANY SIDE
 5. EXPOSED PAD SHALL BE SOLDER PLATED
 6. SHADED AREA IS ONLY A REFERENCE FOR PIN 1 LOCATION ON TOP AND BOTTOM OF PACKAGE

RECOMMENDED SOLDER PAD PITCH AND DIMENSIONS
(002) DRN 1203

PACKAGE DESCRIPTION

MS8 Package
8-Lead Plastic MSOP
 (Reference LTC DWG # 05-08-1660)

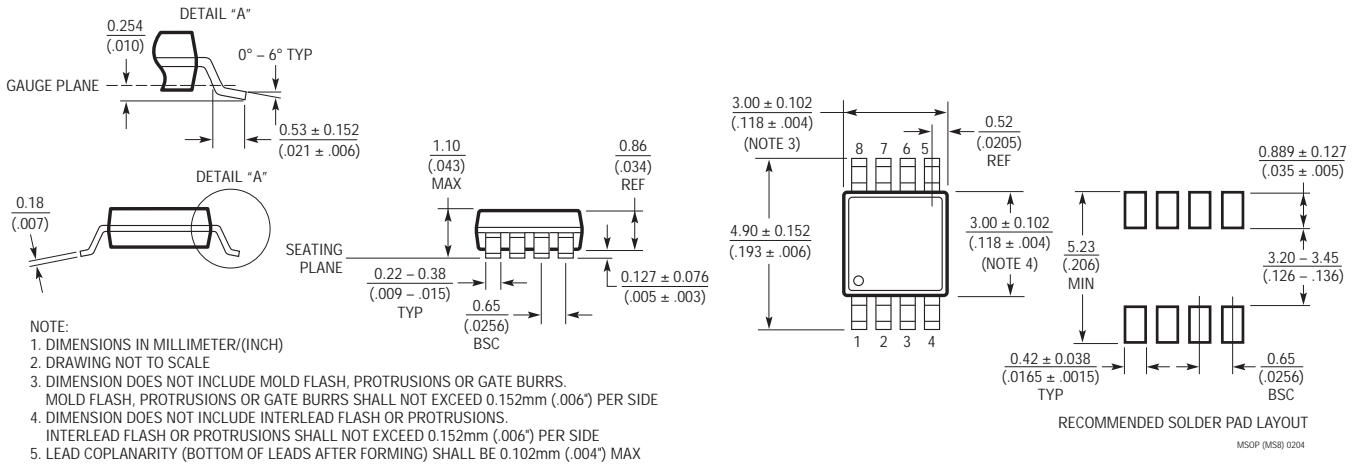

MS Package
10-Lead Plastic MSOP
 (Reference LTC DWG # 05-08-1661)



PACKAGE DESCRIPTION

S8 Package 8-Lead Plastic Small Outline (Narrow .150 Inch) (Reference LTC DWG # 05-08-1610)



GN Package 16-Lead Plastic SSOP (Narrow .150 Inch) (Reference LTC DWG # 05-08-1641)



S Package 14-Lead Plastic Small Outline (Narrow .150 Inch) (Reference LTC DWG # 05-08-1610)



514 0502

TYPICAL APPLICATION

Paralleling Amplifiers to Improve Noise



$$\frac{V_{OUT}}{V_{IN}} = 3 \frac{R_2}{R_1}; \text{ INPUT DC - 10Hz NOISE} \approx 0.8\mu\text{V}_{p-p} = \frac{\text{NOISE OF EACH PARALLEL OP AMP}}{\sqrt{3}}$$

20512 F02

RELATED PARTS

| PART NUMBER | DESCRIPTION | COMMENTS |
|-----------------|---|--|
| LTC1051/LTC1053 | Precision Zero-Drift Op Amp | Dual/Quad |
| LTC1151 | ±15V Zero-Drift Op Amp | Dual High Voltage Operation ±18V |
| LTC1152 | Rail-to-Rail Input and Output Zero-Drift Op Amp | Single Zero-Drift Op Amp with Rail-to-Rail Input and Output and Shutdown |
| LTC2050 | Zero-Drift Op Amp in SOT-23 | Single Supply Operation 2.7V to ±5V, Shutdown |
| LTC2053 | Zero-Drift Precision Instrumentation Amp | MS8, 116dB CMRR, Two External Resistors Set Gain |
| LTC6800 | Rail-to-Rail Input and Output Instrumentation Amp | Low Cost, MS8, Two External Resistors Set Gain |

Looking for pricing, stock, or lifecycle information?

Click below to explore more details on WIN SOURCE:

- ⊖ [View LTC2051HVHS8#PBF on WIN SOURCE](#)
- ⊖ [Linear Technology Information](#)

Optimize Your Supply Chain with WIN SOURCE Solutions

- ✓ Global Sourcing Solution
- ✓ Obsolete Management
- ✓ Cost Control Management
- ✓ Shortage Management
- ✓ Alternative Solution
- ✓ Excess Inventory Management