



**THE DATASHEET OF
MOC3010SR2VM**



MOC3010M, MOC3011M, MOC3012M, MOC3020M, MOC3021M, MOC3022M, MOC3023M



ON Semiconductor®

www.onsemi.com

6-Pin DIP Random-Phase Triac Driver Output Optocoupler (250/400 V Peak)

Description

The MOC301XM and MOC302XM series are optically isolated triac driver devices. These devices contain a GaAs infrared emitting diode and a light activated silicon bilateral switch, which functions like a triac. They are designed for interfacing between electronic controls and power triacs to control resistive and inductive loads for 115 V_{AC} operations.

Features

- Excellent I_{FT} Stability – IR Emitting Diode Has Low Degradation
- Peak Blocking Voltage
 - ◆ 250 V, MOC301XM
 - ◆ 400 V, MOC302XM
- Safety and Regulatory Approvals
 - ◆ UL1577, 4,170 V_{ACRMS} for 1 Minute
 - ◆ DIN EN/IEC60747-5-5
- These are Pb-Free Devices

Applications

- Industrial Controls
- Solenoid/Valve Controls
- Traffic Lights
- Static AC Power Switch
- Vending Machines
- Incandescent Lamp Dimmers
- Solid State Relay
- Motor Control
- Lamp Ballasts

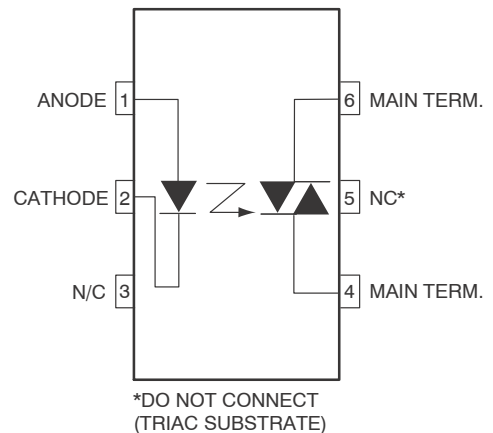
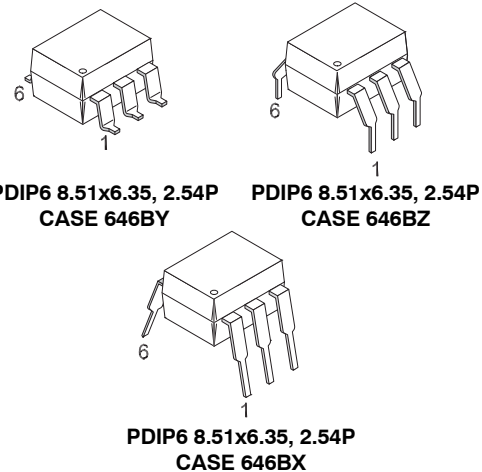

Figure 1. Schematic

ORDERING INFORMATION

See detailed ordering and shipping information on page 8 of this data sheet.

SAFETY AND INSULATION RATINGS

As per DIN EN/IEC 60747-5-5, this optocoupler is suitable for “safe electrical insulation” only within the safety limit data. Compliance with the safety ratings shall be ensured by means of protective circuits.

Parameter		Characteristics
Installation Classifications per DIN VDE 0110/1.89 Table 1, For Rated Mains Voltage	< 150 V _{RMS}	I-IV
	< 300 V _{RMS}	I-IV
Climatic Classification		40/85/21
Pollution Degree (DIN VDE 0110/1.89)		2
Comparative Tracking Index		175

Symbol	Parameter	Value	Unit
V _{PR}	Input-to-Output Test Voltage, Method A, V _{IORM} × 1.6 = V _{PR} , Type and Sample Test with t _m = 10 s, Partial Discharge < 5 pC	1275	V _{peak}
	Input-to-Output Test Voltage, Method B, V _{IORM} × 1.875 = V _{PR} , 100% Production Test with t _m = 1 s, Partial Discharge < 5 pC	1594	V _{peak}
V _{IORM}	Maximum Working Insulation Voltage	850	V _{peak}
V _{IOTM}	Highest Allowable Over-Voltage	6000	V _{peak}
	External Creepage	≥ 7	mm
	External Clearance	≥ 7	mm
	External Clearance (for Option TV, 0.4” Lead Spacing)	≥ 10	mm
DTI	Distance Through Insulation (Insulation Thickness)	≥ 0.5	mm
R _{IO}	Insulation Resistance at T _S , V _{IO} = 500 V	> 10 ⁹	Ω

MOC3010M, MOC3011M, MOC3012M, MOC3020M, MOC3021M, MOC3022M, MOC3023M

ABSOLUTE MAXIMUM RATINGS (T_A = 25°C unless otherwise specified)

Symbol	Parameters	Device	Value	Unit
--------	------------	--------	-------	------

Total Device

T _{STG}	Storage Temperature	All	-40 to 150	°C
T _{OPR}	Operating Temperature	All	-40 to 85	°C
T _J	Junction Temperature Range	All	-40 to 100	°C
T _{SOL}	Lead Solder Temperature	All	260 for 10 seconds	°C
P _D	Total Device Power Dissipation at 25°C Ambient	All	330	mW
	Derate Above 25°C		4.4	mW/°C

Emitter

I _F	Continuous Forward Current	All	60	mA
V _R	Reverse Voltage	All	3	V
P _D	Total Power Dissipation at 25°C Ambient	All	100	mW
	Derate Above 25°C		1.33	mW/°C

Detector

V _{DRM}	Off-State Output Terminal Voltage	MOC3010M, MOC3011M, MOC3012M	250	V
		MOC3020M, MOC3021M, MOC3022M, MOC3023M	400	
I _{TSM}	Peak Repetitive Surge Current (PW = 100 μs, 120 pps)	All	1	A
P _D	Total Power Dissipation at 25°C Ambient	All	300	mW
	Derate Above 25°C		4	mW/°C

Stresses exceeding those listed in the Maximum Ratings table may damage the device. If any of these limits are exceeded, device functionality should not be assumed, damage may occur and reliability may be affected.

MOC3010M, MOC3011M, MOC3012M, MOC3020M, MOC3021M, MOC3022M, MOC3023M

ELECTRICAL CHARACTERISTICS

$T_A = 25^\circ\text{C}$ unless otherwise specified

INDIVIDUAL COMPONENT CHARACTERISTICS

Symbol	Parameters	Test Conditions	Device	Min.	Typ.	Max.	Unit
Emitter							
V_F	Input Forward Voltage	$I_F = 10\text{ mA}$	All		1.15	1.50	V
I_R	Reverse Leakage Current	$V_R = 3\text{ V}, T_A = 25^\circ\text{C}$	All		0.01	100	μA
Detector							
I_{DRM}	Peak Blocking Current, Either Direction	Rated $V_{\text{DRM}}, I_F = 0^{(1)}$	All		10	100	nA
V_{TM}	Peak On-State Voltage, Either Direction	$I_{\text{TM}} = 100\text{ mA peak}, I_F = 0$	All		1.8	3.0	V

1. Test voltage must be applied within dv/dt rating.

TRANSFER CHARACTERISTICS

Symbol	DC Characteristics	Test Conditions	Device	Min.	Typ.	Max.	Unit
I_{FT}	LED Trigger Current	Voltage = 3 V ⁽²⁾	MOC3020M			30	mA
			MOC3010M			15	
			MOC3021M				
			MOC3011M			10	
			MOC3022M				
			MOC3012M			5	
			MOC3023M				
I_H	Holding Current, Either Direction		All		100		μA

2. All devices are guaranteed to trigger at an I_F value less than or equal to max I_{FT} . Therefore, recommended operating I_F lies between max I_{FT} (30 mA for MOC3020M, 15 mA for MOC3010M and MOC3021M, 10 mA for MOC3011M and MOC3022M, 5 mA for MOC3012M and MOC3023M) and absolute maximum I_F (60 mA).

ISOLATION CHARACTERISTICS

Symbol	Parameters	Test Conditions	Device	Min.	Typ.	Max.	Unit
V_{ISO}	Isolation Voltage ⁽³⁾	$t = 1\text{ Minute}$	All	4170			V_{ACRMS}

3. Isolation voltage, V_{ISO} , is an internal device dielectric breakdown rating. For this test, pins 1 and 2 are common, and pins 4, 5 and 6 are common.

Product parametric performance is indicated in the Electrical Characteristics for the listed test conditions, unless otherwise noted. Product performance may not be indicated by the Electrical Characteristics if operated under different conditions.

TYPICAL PERFORMANCE CURVES



Figure 2. LED Forward Voltage vs. Forward Current



Figure 3. On-State Characteristics

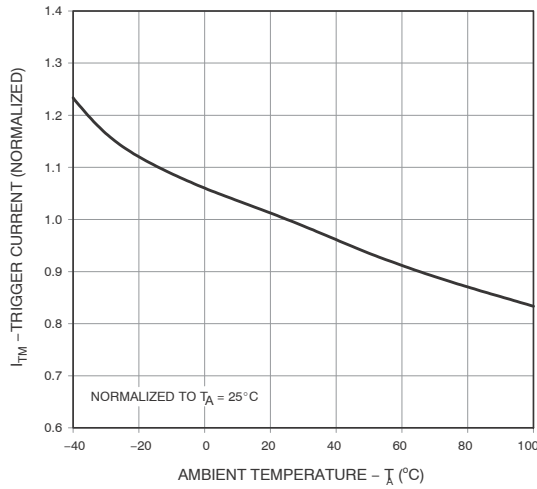

Figure 4. Trigger Current vs. Ambient Temperature

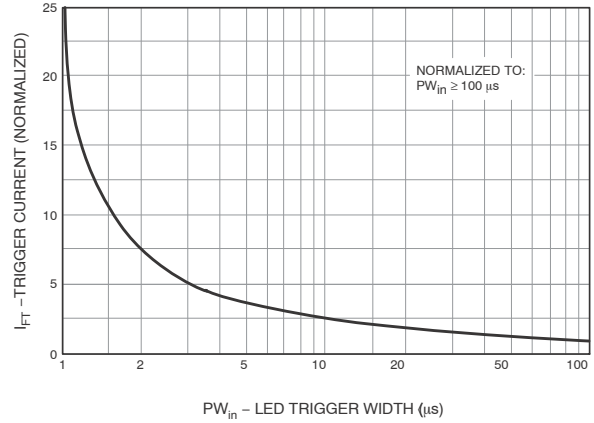

Figure 5. LED Current Required to Trigger vs. LED Pulse Width

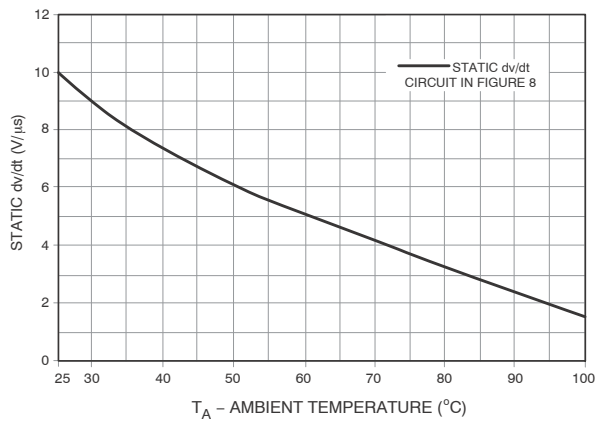

Figure 6. dv/dt vs. Temperature

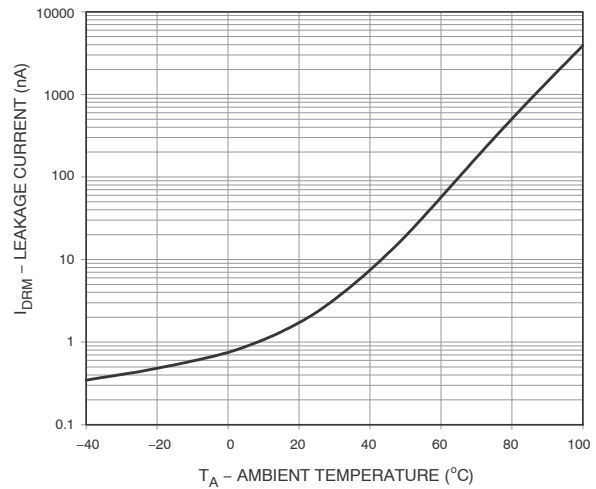

Figure 7. Leakage Current, I_{DRM} vs. Temperature

MOC3010M, MOC3011M, MOC3012M, MOC3020M, MOC3021M, MOC3022M, MOC3023M



1. The mercury wetted relay provides a high speed repeated pulse to the D.U.T.
2. 100x scope probes are used, to allow high speeds and voltages.
3. The worst-case condition for static dv/dt is established by triggering the DUT with a normal LED input current, then removing the current. The variable R_{TEST} allows the dv/dt to be gradually increased until the DUT continues to trigger in response to the applied voltage pulse, even after the LED current has been removed. The dv/dt is then decreased until the DUT stops triggering. τ_{RC} is measured at this point and recorded.



Note:

This optoisolator should not be used to drive a load directly. It is intended to be a trigger device only.

Figure 8. Static dv/dt Test Circuit



Figure 9. Resistive Load



Figure 10. Inductive Load with Sensitive Gate Triac ($I_{GT} \leq 15 \text{ mA}$)



Figure 11. Inductive Load with Sensitive Triac ($I_{GT} \leq 15 \text{ mA}$)



In this circuit the “hot” side of the line is switched and the load connected to the cold or ground side. The 39 Ω resistor and 0.01 μF capacitor are for snubbing of the triac, and the 470 Ω resistor and 0.05 μF capacitor are for snubbing the coupler. These components may or may not be necessary depending upon the particular and load used.

Figure 12. Typical Application Circuit

Reflow Profile

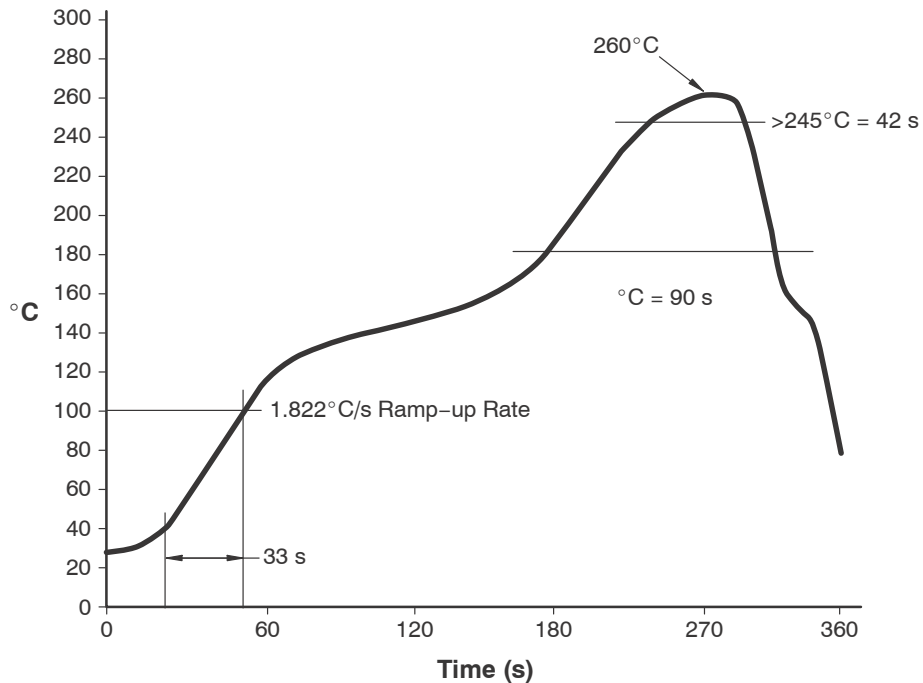

Figure 13. Reflow Profile

MOC3010M, MOC3011M, MOC3012M, MOC3020M, MOC3021M, MOC3022M, MOC3023M

ORDERING INFORMATION

Part Number	Package	Shipping
MOC3010M	DIP 6-Pin	50 Units / Tube
MOC3010SM	SMT 6-Pin (Lead Bend)	50 Units / Tube
MOC3010SR2M	SMT 6-Pin (Lead Bend)	1000 Units / Tape & Reel
MOC3010VM	DIP 6-Pin, DIN EN/IEC60747-5-5 Option	50 Units / Tube
MOC3010SVM	SMT 6-Pin (Lead Bend), DIN EN/IEC60747-5-5 Option	50 Units / Tube
MOC3010SR2VM	SMT 6-Pin (Lead Bend), DIN EN/IEC60747-5-5 Option	1000 Units / Tape & Reel
MOC3010TVM	DIP 6-Pin, 0.4" Lead Spacing, DIN EN/IEC60747-5-5 Option	50 Units / Tube

NOTE: The product orderable part number system listed in this table also applies to the MOC3011M, MOC3012M, MOC3020M, MOC3021M, MOC3022M, and MOC3023M product families.

MARKING INFORMATION



Figure 14. Top Marking

Top Mark Definitions	
1	ON Semiconductor Logo
2	Device Number
3	DIN EN/IEC60747-5-5 Option (only appears on component ordered with this option)
4	One-Digit Year Code, e.g., '5'
5	Two-Digit Work Week, Ranging from '01' to '53'
6	Assembly Package Code

MECHANICAL CASE OUTLINE
PACKAGE DIMENSIONS

PDIP6 8.51x6.35, 2.54P
CASE 646BX
ISSUE O

DATE 31 JUL 2016

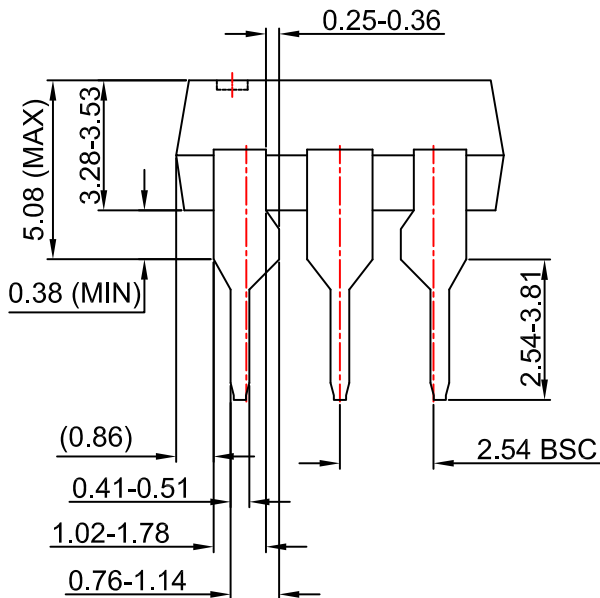

NOTES:

- A) NO STANDARD APPLIES TO THIS PACKAGE.
- B) ALL DIMENSIONS ARE IN MILLIMETERS.
- C) DIMENSIONS ARE EXCLUSIVE OF BURRS, MOLD FLASH, AND TIE BAR EXTRUSION

DOCUMENT NUMBER:	98AON13449G	Electronic versions are uncontrolled except when accessed directly from the Document Repository. Printed versions are uncontrolled except when stamped "CONTROLLED COPY" in red.
STATUS:	ON SEMICONDUCTOR STANDARD	
NEW STANDARD:		
DESCRIPTION:	PDIP6 8.51X6.35, 2.54P	PAGE 1 OF 2

MECHANICAL CASE OUTLINE

PACKAGE DIMENSIONS

ON Semiconductor®



PDIP6 8.51x6.35, 2.54P
CASE 646BY
ISSUE O

DATE 31 JUL 2016

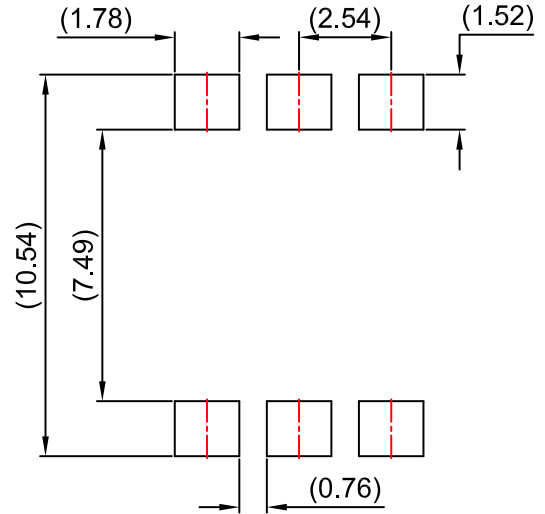
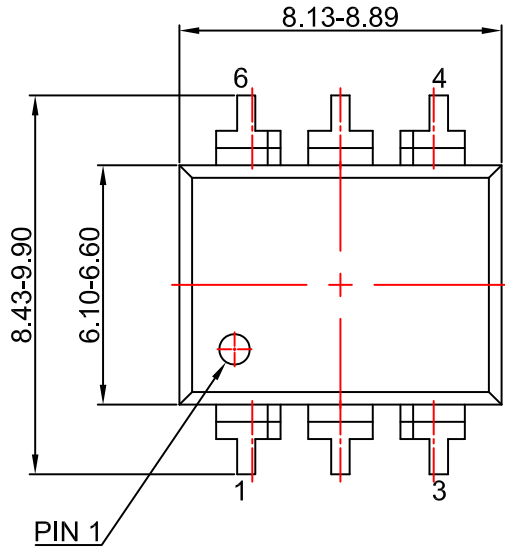

LAND PATTERN RECOMMENDATION

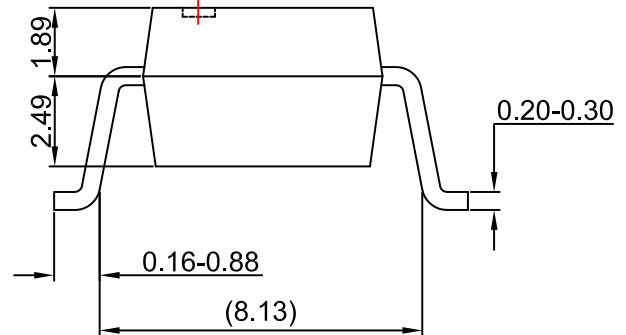
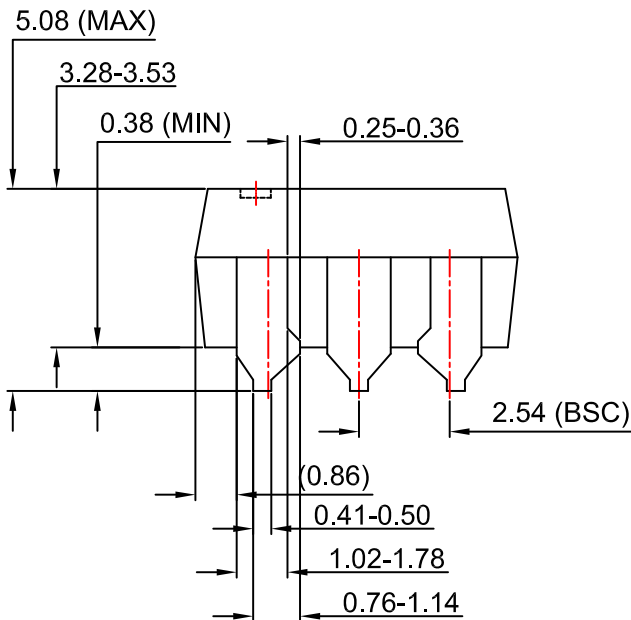

NOTES:

- A) NO STANDARD APPLIES TO THIS PACKAGE.
- B) ALL DIMENSIONS ARE IN MILLIMETERS.
- C) DIMENSIONS ARE EXCLUSIVE OF BURRS, MOLD FLASH, AND TIE BAR EXTRUSION

DOCUMENT NUMBER:	98AON13450G	Electronic versions are uncontrolled except when accessed directly from the Document Repository. Printed versions are uncontrolled except when stamped "CONTROLLED COPY" in red.
STATUS:	ON SEMICONDUCTOR STANDARD	
NEW STANDARD:		
DESCRIPTION:	PDIP6 8.51X6.35, 2.54P	PAGE 1 OF 2

MECHANICAL CASE OUTLINE
PACKAGE DIMENSIONS

PDIP6 8.51x6.35, 2.54P
CASE 646BZ
ISSUE O

DATE 31 JUL 2016

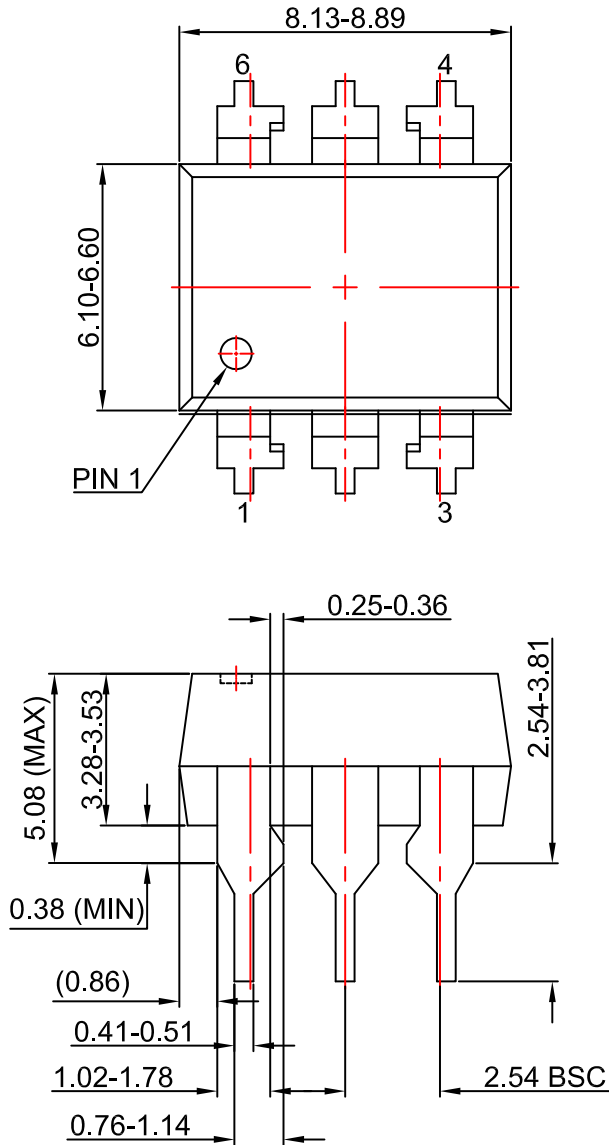

NOTES:

- A) NO STANDARD APPLIES TO THIS PACKAGE.
- B) ALL DIMENSIONS ARE IN MILLIMETERS.
- C) DIMENSIONS ARE EXCLUSIVE OF BURRS, MOLD FLASH, AND TIE BAR EXTRUSION

DOCUMENT NUMBER:	98AON13451G	Electronic versions are uncontrolled except when accessed directly from the Document Repository. Printed versions are uncontrolled except when stamped "CONTROLLED COPY" in red.
STATUS:	ON SEMICONDUCTOR STANDARD	
NEW STANDARD:		
DESCRIPTION:	PDIP6 8.51X6.35, 2.54P	PAGE 1 OF 2

ON Semiconductor and  are trademarks of Semiconductor Components Industries, LLC dba ON Semiconductor or its subsidiaries in the United States and/or other countries. ON Semiconductor owns the rights to a number of patents, trademarks, copyrights, trade secrets, and other intellectual property. A listing of ON Semiconductor's product/patent coverage may be accessed at www.onsemi.com/site/pdf/Patent-Marking.pdf. ON Semiconductor reserves the right to make changes without further notice to any products herein. ON Semiconductor makes no warranty, representation or guarantee regarding the suitability of its products for any particular purpose, nor does ON Semiconductor assume any liability arising out of the application or use of any product or circuit, and specifically disclaims any and all liability, including without limitation special, consequential or incidental damages. Buyer is responsible for its products and applications using ON Semiconductor products, including compliance with all laws, regulations and safety requirements or standards, regardless of any support or applications information provided by ON Semiconductor. "Typical" parameters which may be provided in ON Semiconductor data sheets and/or specifications can and do vary in different applications and actual performance may vary over time. All operating parameters, including "Typicals" must be validated for each customer application by customer's technical experts. ON Semiconductor does not convey any license under its patent rights nor the rights of others. ON Semiconductor products are not designed, intended, or authorized for use as a critical component in life support systems or any FDA Class 3 medical devices or medical devices with a same or similar classification in a foreign jurisdiction or any devices intended for implantation in the human body. Should Buyer purchase or use ON Semiconductor products for any such unintended or unauthorized application, Buyer shall indemnify and hold ON Semiconductor and its officers, employees, subsidiaries, affiliates, and distributors harmless against all claims, costs, damages, and expenses, and reasonable attorney fees arising out of, directly or indirectly, any claim of personal injury or death associated with such unintended or unauthorized use, even if such claim alleges that ON Semiconductor was negligent regarding the design or manufacture of the part. ON Semiconductor is an Equal Opportunity/Affirmative Action Employer. This literature is subject to all applicable copyright laws and is not for resale in any manner.

PUBLICATION ORDERING INFORMATION

LITERATURE FULFILLMENT:

Literature Distribution Center for ON Semiconductor
19521 E. 32nd Pkwy, Aurora, Colorado 80011 USA
Phone: 303-675-2175 or 800-344-3860 Toll Free USA/Canada
Fax: 303-675-2176 or 800-344-3867 Toll Free USA/Canada
Email: orderlit@onsemi.com

N. American Technical Support: 800-282-9855 Toll Free
USA/Canada
Europe, Middle East and Africa Technical Support:
Phone: 421 33 790 2910

ON Semiconductor Website: www.onsemi.com

Order Literature: <http://www.onsemi.com/orderlit>

For additional information, please contact your local
Sales Representative

Looking for pricing, stock, or lifecycle information?

Click below to explore more details on WIN SOURCE:

- ⊖ [View MOC3010SR2VM on WIN SOURCE](#)
- ⊖ [Fairchild/ON Semiconductor Information](#)

Optimize Your Supply Chain with WIN SOURCE Solutions

- ✓ Global Sourcing Solution
- ✓ Obsolete Management
- ✓ Cost Control Management
- ✓ Shortage Management
- ✓ Alternative Solution
- ✓ Excess Inventory Management