



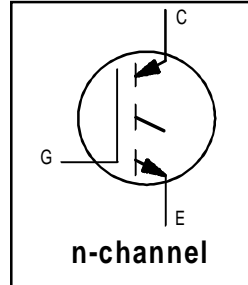
# IRG4RC10K

INSULATED GATE BIPOLAR TRANSISTOR

Short Circuit Rated  
 UltraFast IGBT

### Features

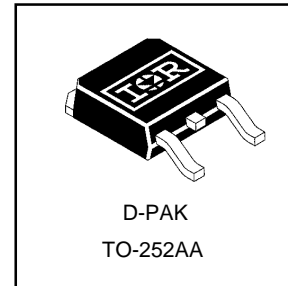
- Short Circuit Rated UltraFast: Optimized for high operating frequencies >5.0 kHz, and Short Circuit Rated to 10 $\mu$ s @ 125°C, V<sub>GE</sub> = 15V
- Generation 4 IGBT design provides higher efficiency than Generation 3
- Industry standard TO-252AA package



V <sub>CES</sub> = 600V
V <sub>CE(on)</sub> typ. = 2.39V
@ V <sub>GE</sub> = 15V, I <sub>C</sub> = 5.0A

### Benefits

- Generation 4 IGBT's offer highest efficiency available
- IGBT's optimized for specified application conditions



### Absolute Maximum Ratings

	Parameter	Max.	Units
V <sub>CES</sub>	Collector-to-Emitter Breakdown Voltage	600	V
I <sub>C</sub> @ T <sub>C</sub> = 25°C	Continuous Collector Current	9.0	A
I <sub>C</sub> @ T <sub>C</sub> = 100°C	Continuous Collector Current	5.0	
I <sub>CM</sub>	Pulsed Collector Current ①	18	
I <sub>LM</sub>	Clamped Inductive Load Current ②	18	
t <sub>sc</sub>	Short Circuit Withstand Time	10	$\mu$ s
V <sub>GE</sub>	Gate-to-Emitter Voltage	$\pm$ 20	V
E <sub>ARV</sub>	Reverse Voltage Avalanche Energy ③	34	mJ
P <sub>D</sub> @ T <sub>C</sub> = 25°C	Maximum Power Dissipation	38	W
P <sub>D</sub> @ T <sub>C</sub> = 100°C	Maximum Power Dissipation	15	
T <sub>J</sub>	Operating Junction and	-55 to + 150	°C
T <sub>STG</sub>	Storage Temperature Range		
	Soldering Temperature, for 10 seconds	300 (0.063 in. (1.6mm) from case )	

### Thermal Resistance

	Parameter	Typ.	Max.	Units
R <sub>θJC</sub>	Junction-to-Case	—	3.3	°C/W
R <sub>θJA</sub>	Junction-to-Ambient (PCB mount)*	—	50	
Wt	Weight	0.3 (0.01)	—	g (oz)

\* When mounted on 1" square PCB (FR-4 or G-10 Material).

For recommended footprint and soldering techniques refer to application note #AN-994

# IRG4RC10K

## Electrical Characteristics @ $T_J = 25^\circ\text{C}$ (unless otherwise specified)

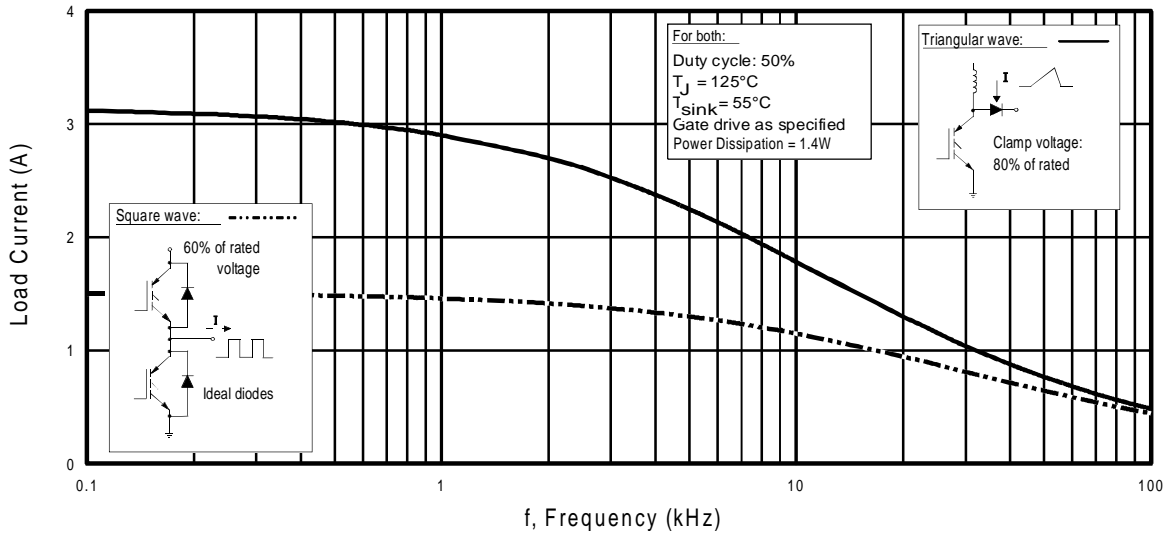
	Parameter	Min.	Typ.	Max.	Units	Conditions
$V_{(BR)CES}$	Collector-to-Emitter Breakdown Voltage	600	—	—	V	$V_{GE} = 0V, I_C = 250\mu A$
$V_{(BR)ECS}$	Emitter-to-Collector Breakdown Voltage ④	18	—	—	V	$V_{GE} = 0V, I_C = 1.0A$
$\Delta V_{(BR)CES}/\Delta T_J$	Temperature Coeff. of Breakdown Voltage	—	0.58	—	V/ $^\circ\text{C}$	$V_{GE} = 0V, I_C = 1.0mA$
$V_{CE(ON)}$	Collector-to-Emitter Saturation Voltage	—	2.39	2.62	V	$I_C = 5.0A$ $V_{GE} = 15V$ See Fig.2, 5
		—	3.25	—		
		—	2.63	—		
$V_{GE(th)}$	Gate Threshold Voltage	3.0	—	6.5		$V_{CE} = V_{GE}, I_C = 250\mu A$
$\Delta V_{GE(th)}/\Delta T_J$	Temperature Coeff. of Threshold Voltage	—	-11	—	mV/ $^\circ\text{C}$	$V_{CE} = V_{GE}, I_C = 250\mu A$
$g_{fe}$	Forward Transconductance ⑤	1.2	1.8	—	S	$V_{CE} = 50V, I_C = 5.0A$
$I_{CES}$	Zero Gate Voltage Collector Current	—	—	250	$\mu A$	$V_{GE} = 0V, V_{CE} = 600V$
		—	—	2.0		$V_{GE} = 0V, V_{CE} = 10V, T_J = 25^\circ\text{C}$
		—	—	1000		$V_{GE} = 0V, V_{CE} = 600V, T_J = 150^\circ\text{C}$
$I_{GES}$	Gate-to-Emitter Leakage Current	—	—	$\pm 100$	nA	$V_{GE} = \pm 20V$

## Switching Characteristics @ $T_J = 25^\circ\text{C}$ (unless otherwise specified)

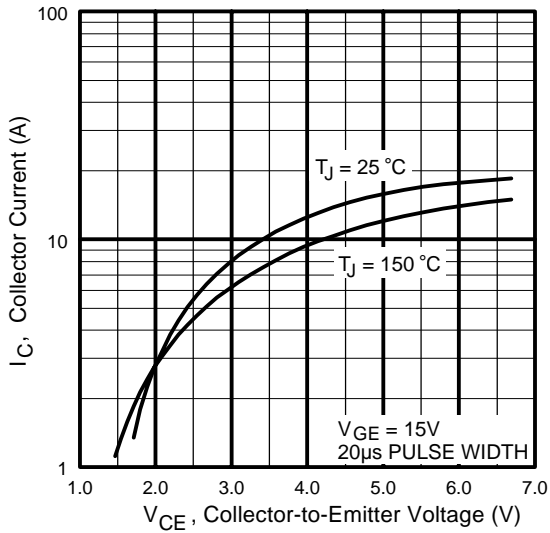
	Parameter	Min.	Typ.	Max.	Units	Conditions
$Q_g$	Total Gate Charge (turn-on)	—	19	29	nC	$I_C = 5.0A$ $V_{CC} = 400V$ See Fig.8 $V_{GE} = 15V$
$Q_{ge}$	Gate - Emitter Charge (turn-on)	—	2.9	4.3		
$Q_{gc}$	Gate - Collector Charge (turn-on)	—	9.8	15		
$t_{d(on)}$	Turn-On Delay Time	—	11	—	ns	$T_J = 25^\circ\text{C}$ $I_C = 5.0A, V_{CC} = 480V$ $V_{GE} = 15V, R_G = 100\Omega$ Energy losses include "tail" See Fig. 9,10,14
$t_r$	Rise Time	—	24	—		
$t_{d(off)}$	Turn-Off Delay Time	—	51	77		
$t_f$	Fall Time	—	190	290		
$E_{on}$	Turn-On Switching Loss	—	0.16	—		
$E_{off}$	Turn-Off Switching Loss	—	0.10	—	mJ	See Fig. 9,10,14
$E_{ts}$	Total Switching Loss	—	0.26	0.32		
$t_{sc}$	Short Circuit Withstand Time	10	—	—	$\mu s$	$V_{CC} = 400V, T_J = 125^\circ\text{C}$ $V_{GE} = 15V, R_G = 100\Omega, V_{CPK} < 500V$
$t_{d(on)}$	Turn-On Delay Time	—	11	—	ns	$T_J = 150^\circ\text{C}$ $I_C = 5.0A, V_{CC} = 480V$ $V_{GE} = 15V, R_G = 100\Omega$ Energy losses include "tail" See Fig. 10,11,14
$t_r$	Rise Time	—	27	—		
$t_{d(off)}$	Turn-Off Delay Time	—	67	—		
$t_f$	Fall Time	—	350	—		
$E_{ts}$	Total Switching Loss	—	0.47	—	mJ	See Fig. 10,11,14
$L_E$	Internal Emitter Inductance	—	7.5	—	nH	Measured 5mm from package
$C_{ies}$	Input Capacitance	—	220	—	pF	$V_{GE} = 0V$ $V_{CC} = 30V$ See Fig. 7 $f = 1.0MHz$
$C_{oes}$	Output Capacitance	—	29	—		
$C_{res}$	Reverse Transfer Capacitance	—	7.5	—		

### Notes:

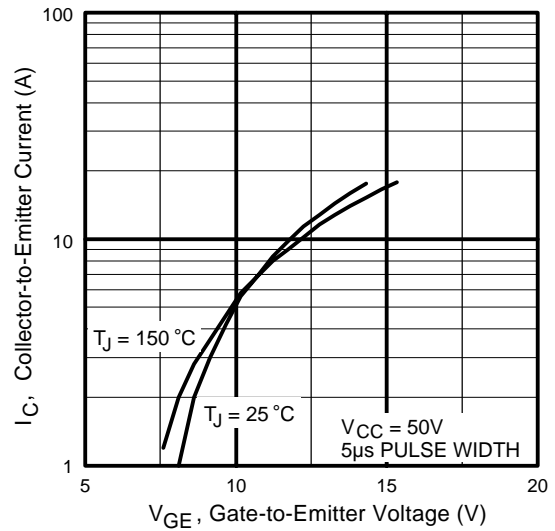
- ① Repetitive rating;  $V_{GE} = 20V$ , pulse width limited by max. junction temperature. ( See fig. 13b )
- ②  $V_{CC} = 80\%(V_{CES}), V_{GE} = 20V, L = 10\mu H, R_G = 100\Omega$ , (See fig. 13a)
- ③ Repetitive rating; pulse width limited by maximum junction temperature.
- ④ Pulse width  $\leq 80\mu s$ ; duty factor  $\leq 0.1\%$ .
- ⑤ Pulse width  $5.0\mu s$ , single shot.



**Fig. 1 - Typical Load Current vs. Frequency**  
(Load Current =  $I_{RMS}$  of fundamental)

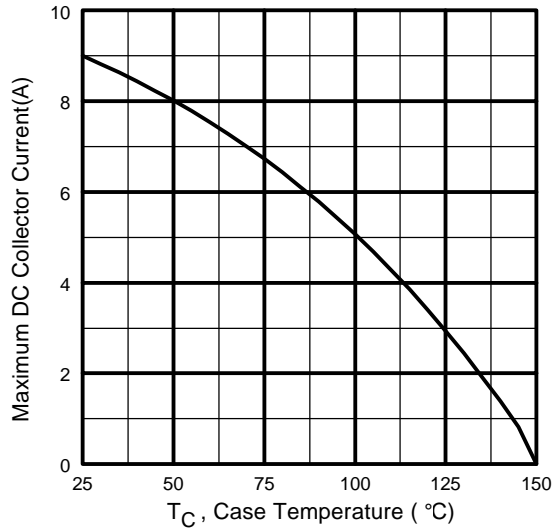


**Fig. 2 - Typical Output Characteristics**

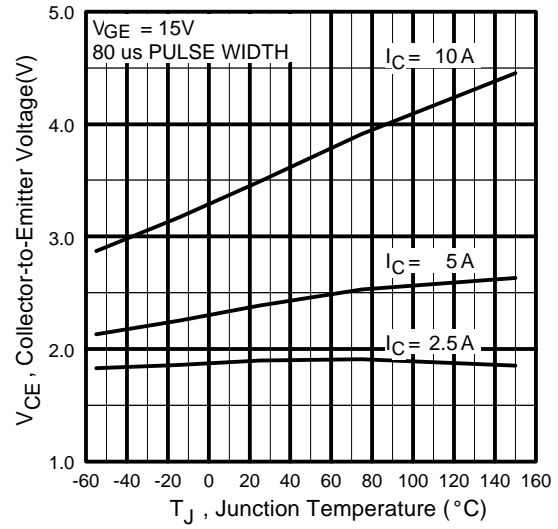


**Fig. 3 - Typical Transfer Characteristics**

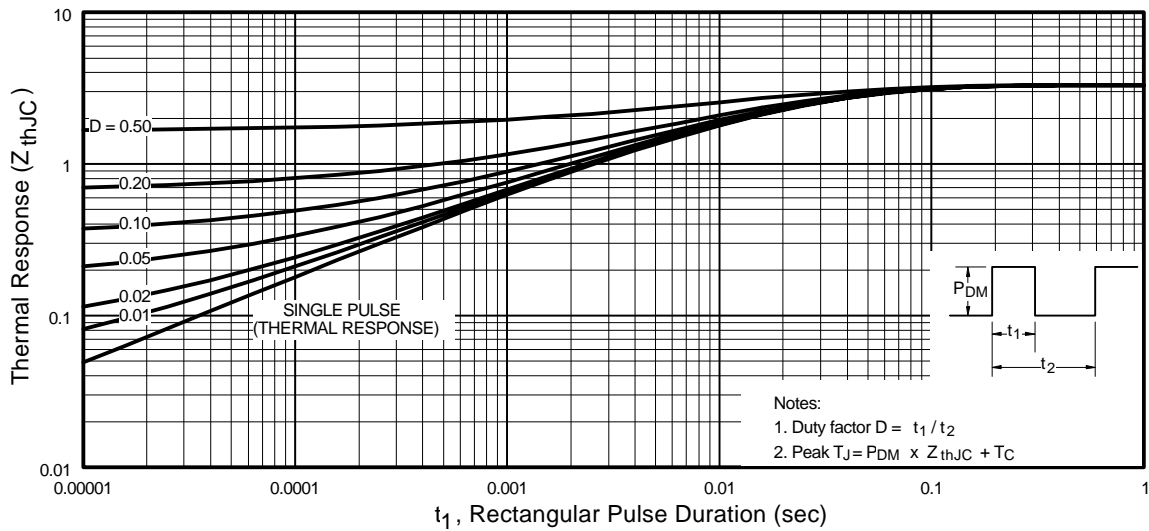
# IRG4RC10K



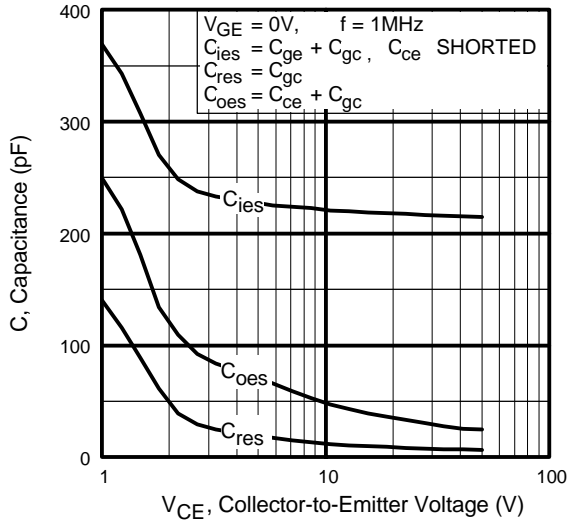
**Fig. 4** - Maximum Collector Current vs. Case Temperature



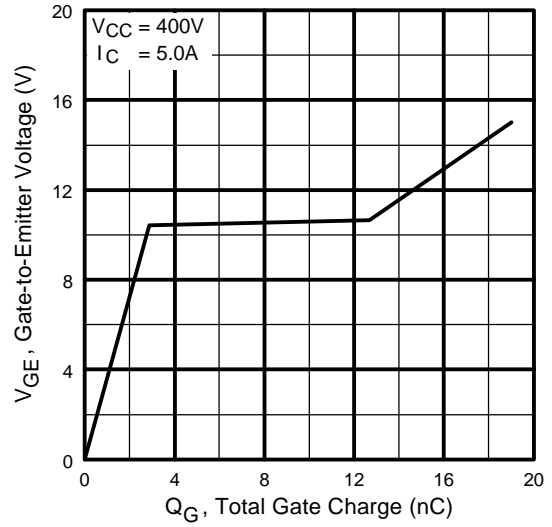
**Fig. 5** - Typical Collector-to-Emitter Voltage vs. Junction Temperature



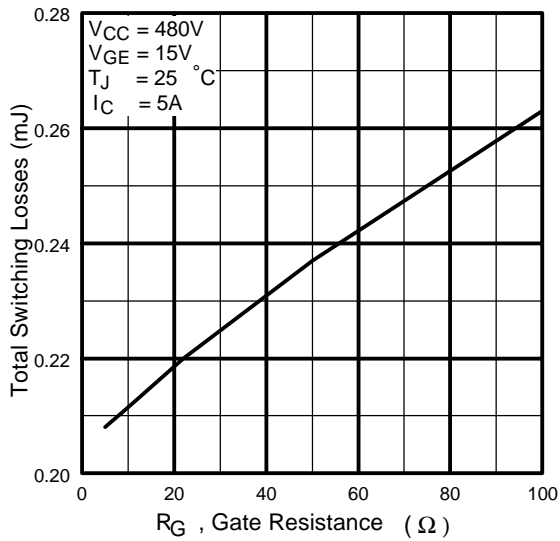
**Fig. 6** - Maximum Effective Transient Thermal Impedance, Junction-to-Case



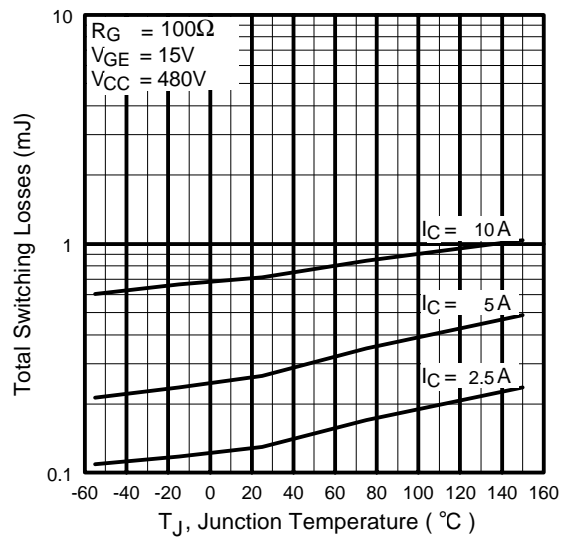
**Fig. 7** - Typical Capacitance vs. Collector-to-Emitter Voltage



**Fig. 8** - Typical Gate Charge vs. Gate-to-Emitter Voltage



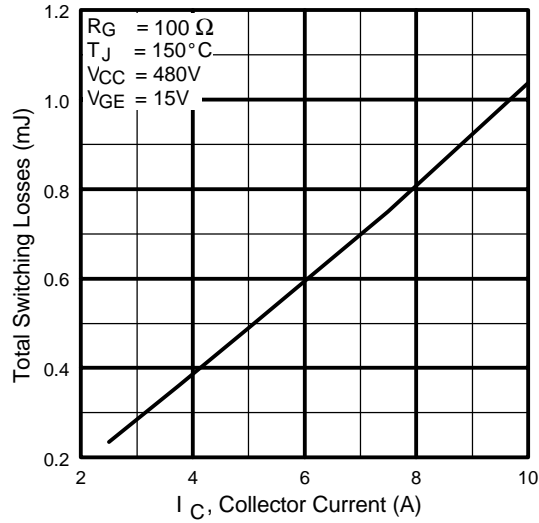
**Fig. 9** - Typical Switching Losses vs. Gate Resistance



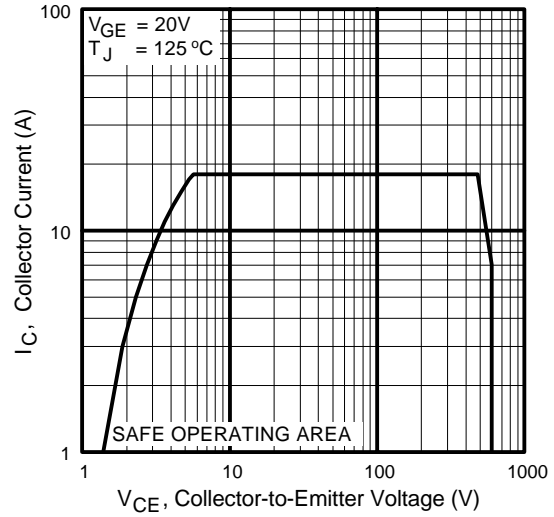
**Fig. 10** - Typical Switching Losses vs. Junction Temperature

# IRG4RC10K

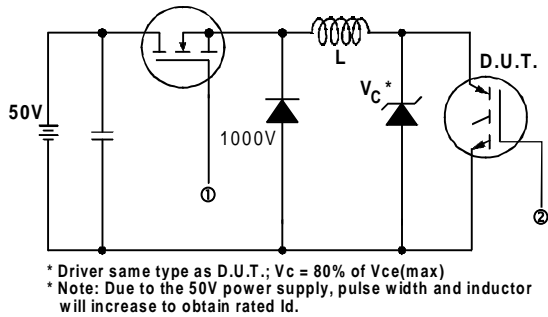
International  
**IRF** Rectifier



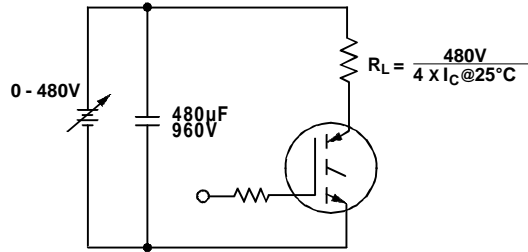
**Fig. 11** - Typical Switching Losses vs. Collector Current



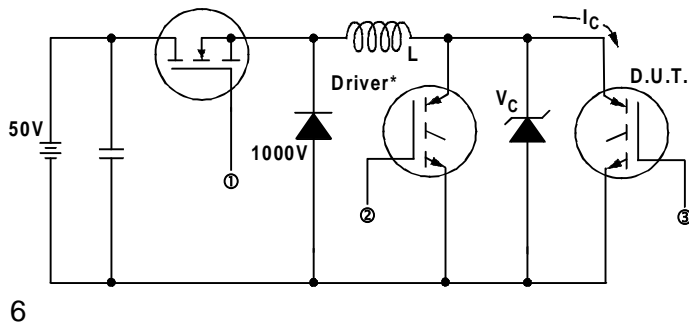
**Fig. 12** - Turn-Off SOA



**Fig. 13a** - Clamped Inductive Load Test Circuit

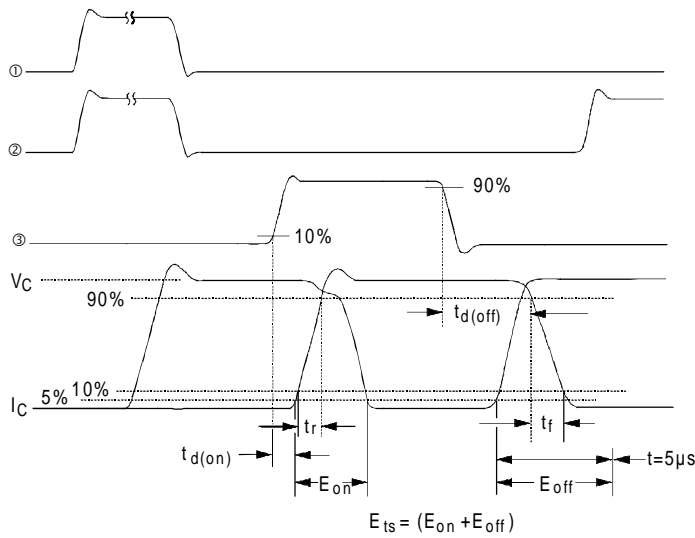


**Fig. 13b** - Pulsed Collector Current Test Circuit



**Fig. 14a** - Switching Loss Test Circuit

\* Driver same type as D.U.T.,  $V_C = 480V$

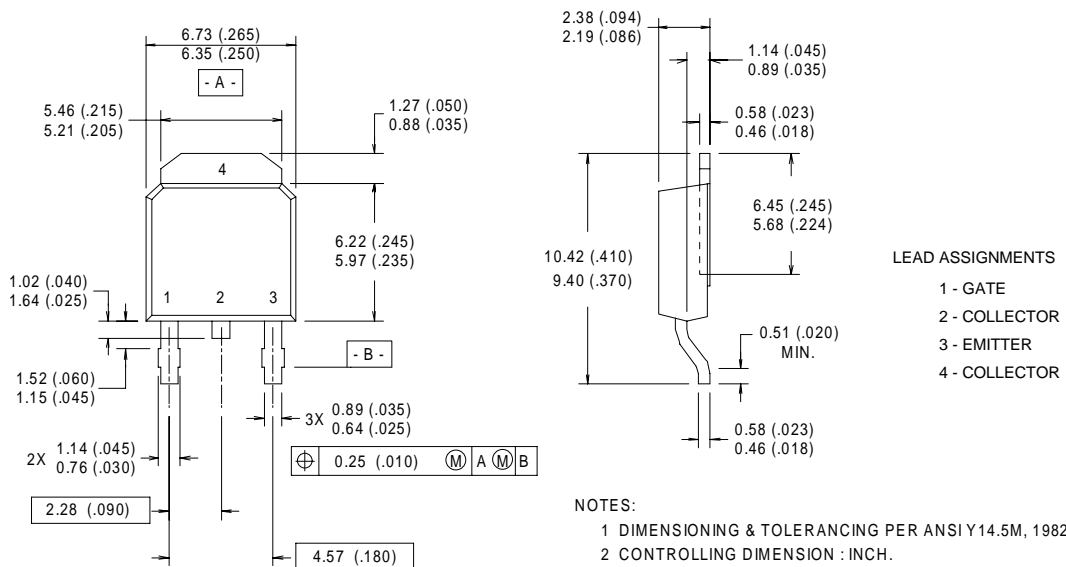


**Fig. 14b** - Switching Loss Waveforms

## Package Outline

### TO-252AA Outline

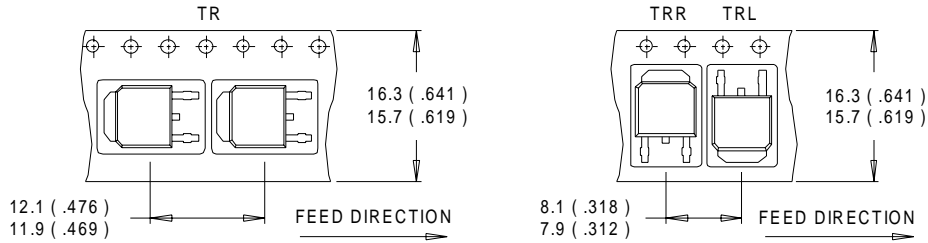
Dimensions are shown in millimeters (inches)



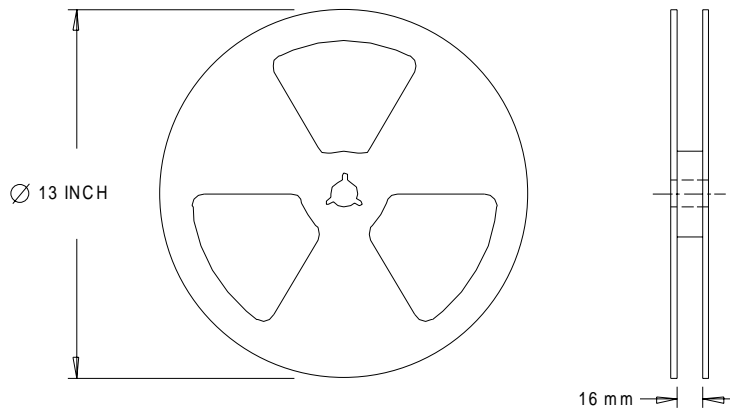
# IRG4RC10K

International  
**IR** Rectifier

## Tape & Reel Information TO-252AA



- NOTES :
1. CONTROLLING DIMENSION : MILLIMETER.
  2. ALL DIMENSIONS ARE SHOWN IN MILLIMETERS ( INCHES ).
  3. OUTLINE CONFORMS TO EIA-481 & EIA-541.



- NOTES :
1. OUTLINE CONFORMS TO EIA-481.

International  
**IR** Rectifier

**IR WORLD HEADQUARTERS:** 233 Kansas St., El Segundo, California 90245, USA Tel: (310) 252-7105  
TAC Fax: (310) 252-7903  
Visit us at [www.irf.com](http://www.irf.com) for sales contact information.  
*Data and specifications subject to change without notice. 12/00*

8

[www.irf.com](http://www.irf.com)

Note: For the most current drawings please refer to the IR website at:  
<http://www.irf.com/package/>

## Looking for pricing, stock, or lifecycle information?

Click below to explore more details on WIN SOURCE:

 [View IRG4RC10KTRL on WIN SOURCE](#)

 [Infineon Technologies](#) Information

## Optimize Your Supply Chain with WIN SOURCE Solutions

-  Global Sourcing Solution
-  Obsolete Management
-  Cost Control Management
-  Shortage Management
-  Alternative Solution
-  Excess Inventory Management