



**THE DATASHEET OF
FD7420006**



3.3V CMOS Low Jitter XO

FD



5.0 x 3.2mm Ceramic SMD

Product Features

- 1 to 133MHz Frequency Range
- <1 ps RMS jitter with fundamental or overtone design
- Low power standby mode
- Pb-free and RoHS/Green compliant

Product Description

The FD Series 3.3V crystal clock oscillator achieves superb jitter and stability over a broad range of operating conditions and frequencies. The output clock signal, generated internally with a non-PLL oscillator design, is compatible with LVCMOS/LVTTL logic levels. The device, available on tape and reel, is contained in a 5.0 x 3.2mm surface-mount ceramic package.

Applications

The FD Series is ideal for compact, high-density applications requiring low jitter or tight stability, including:

- Ethernet
- EPON
- Fibre Channel
- Serial Attached SCSI (SAS)
- Server & Storage platforms
- SONET/SDH linecards
- T1/E1, T3/E3 linecards
- DSLAM
- 802.11 a/b/g WiFi

Package:

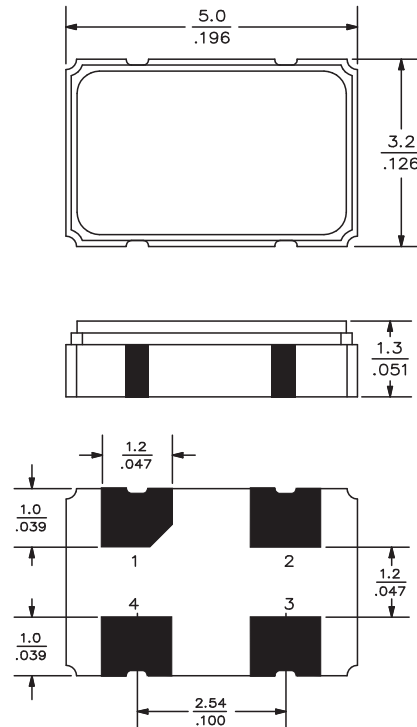

Recommended Land Pattern:

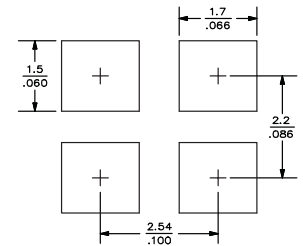

Pin Functions:

Pin	Function
1	OE Function
2	Ground
3	Clock Output
4	V _{DD}

Part Ordering Information:

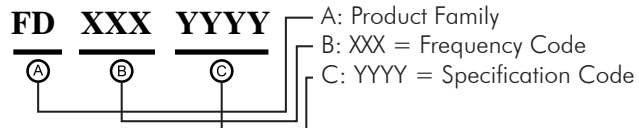

Following the above format, Saronix-eCera part numbers will be assigned upon confirmation of exact customer requirements.

Legacy Ordering Information - For Reference Only:

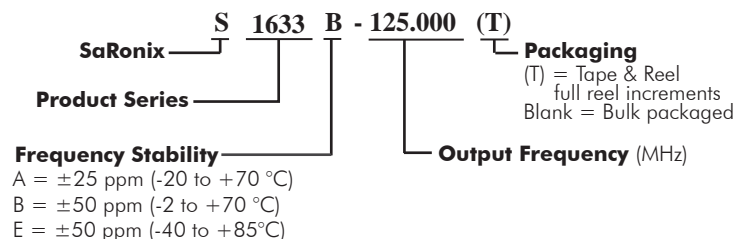

Electrical Performance

Parameter	Min.	Typ.	Max.	Units	Notes
Output Frequency	1		133	MHz	As specified
Supply Voltage	2.97	3.30	3.63	V	
Supply Current, Output Enabled			15	mA	1 to 50 MHz
			25		50 to 80 MHz
			45		80 to 133 MHz
Supply Current, Standby Mode			10	μA	Output Hi-Z
Frequency Stability			±20 to ±50	ppm	See Note 1 below
Operating Temperature Range	-20		+70	°C	Commercial (standard)
	-40		+85		Industrial (standard)
Output Logic 0, V _{OL}			10% V _{DD}	V	
Output Logic 1, V _{OH}	90% V _{DD}			V	
Output Load			15	pF	See Note 2 below
Duty Cycle	45		55	%	Measured 50% V _{DD}
Rise and Fall Time	up to 40 MHz		7	ns	Measured 20/80% of waveform
	40 to 80 MHz		5		
	80 to 133 MHz		2.5		
Jitter, Phase	1 to 133 MHz		1	ps RMS (1-σ)	10kHz to 20 MHz frequency band
Jitter, Accumulated	up to 80 MHz		5	ps RMS (1-σ)	20.000 adjacent periods
	80 to 133 MHz		3		
Jitter, Total	up to 80 MHz		50	ps pk-pk	100.000 random periods
	80 to 133 MHz		30		

Notes:

- Stability includes all combinations of operating temperature, load changes, rated input (supply) voltage changes, initial calibration tolerance (25°C), aging (1 year at 25°C average effective ambient temperature), shock and vibration.
- For specifications other than those listed, please contact sales.

Output Enable / Disable Function

Parameter	Min.	Typ.	Max.	Units	Notes
Input Voltage (pin 1), Output Enable	2.0			V	or open
Input Voltage (pin 1), Output Disable (low power standby)			0.5	V	Output is Hi-Z
Internal Pullup Resistance	50			kΩ	
Output Disable Delay			100	ns	
Output Enable Delay			10	ms	

Absolute Maximum Ratings

Parameter	Min.	Typ.	Max.	Units	Notes
Storage Temperature	-55		+125	°C	

Test Circuit

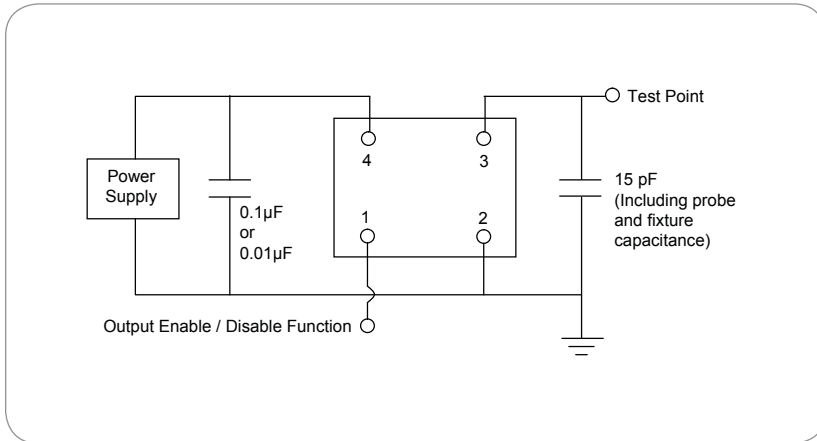

Reflow Soldering Profile

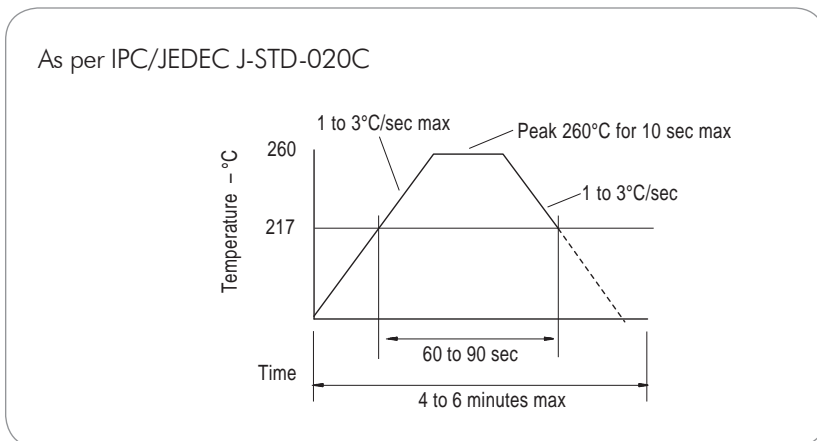

Reliability Test Ratings

This product is rated to meet the following test conditions:

Type	Parameter	Test Condition
Mechanical	Shock	MIL-STD-883, Method 2002, Condition B
Mechanical	Solderability	JESD22-B102-D Method 2 (Preconditioning E)
Mechanical	Terminal strength	MIL-STD-883, Method 2004, Condition D
Mechanical	Gross leak	MIL-STD-883, Method 1014, Condition C
Mechanical	Fine leak	MIL-STD-883, Method 1014, Condition A2 ($R_1 = 2 \times 10^{-8}$ atm cc/s)
Mechanical	Solvent resistance	MIL-STD-202, Method 215
Environmental	Thermal shock	MIL-STD-883, Method 1011, Condition A
Environmental	Moisture resistance	MIL-STD-883, Method 1004
Environmental	Vibration	MIL-STD-883, Method 2007, Condition A
Environmental	Resistance to soldering heat	J-STD-020C Table 5-2 Pb-free devices (2 cycles max)

Looking for pricing, stock, or lifecycle information?

Click below to explore more details on WIN SOURCE:

 [View FD7420006 on WIN SOURCE](#)

 [Diodes Incorporated](#) Information

Optimize Your Supply Chain with WIN SOURCE Solutions

-  Global Sourcing Solution
-  Obsolete Management
-  Cost Control Management
-  Shortage Management
-  Alternative Solution
-  Excess Inventory Management