



**THE DATASHEET OF  
MAX6129AEUK50+T**





# Ultra-Low-Power Series Voltage Reference

MAX6129

## General Description

The MAX6129 micropower, low-dropout bandgap voltage reference combines ultra-low supply current and low drift in a miniature 5-pin SOT23 surface-mount package that uses 70% less board space than comparable devices in an SO package. This series-mode voltage reference sources up to 4mA and sinks up to 1mA of load current. A wide 2.5V to 12.6V supply range, ultra-low 5.25 $\mu$ A (max) supply current, and a low 200mV dropout voltage make these devices ideal for battery-operated systems.

An initial accuracy of 0.4% and a 40ppm/ $^{\circ}$ C (max) temperature coefficient make the MAX6129 suitable for precision applications. Additionally, an internal compensation capacitor eliminates the need for an external compensation capacitor and ensures stability with load capacitances up to 10 $\mu$ F.

The MAX6129 provides six output voltages of 2.048V, 2.5V, 3V, 3.3V, 4.096V, and 5V. The MAX6129 is available in a 5-pin SOT23 package and in die form.

## Applications

Battery-Powered Systems  
Handheld Instruments  
Precision Power Supplies  
A/D and D/A Converters

## Typical Operating Circuit

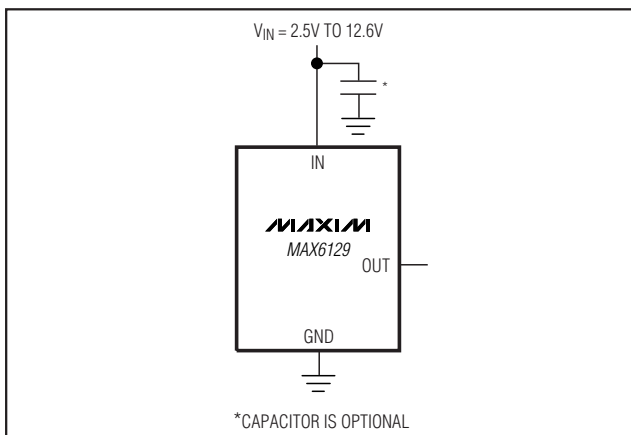

## Features

- ◆ Ultra-Low 5.25 $\mu$ A (max) Supply Current
- ◆ 4mA Output Source Current
- ◆ 1mA Output Sink Current
- ◆  $\pm$ 0.4% (max) Initial Accuracy
- ◆ 40ppm/ $^{\circ}$ C (max) Temperature Coefficient
- ◆ 2.5V to 12.6V Supply Range
- ◆ Low 200mV Dropout
- ◆ Stable with Capacitive Loads Up to 10 $\mu$ F
- ◆ No External Capacitors Required
- ◆ Miniature 5-Pin SOT23 Package

## Ordering Information

PART	TEMP RANGE	PIN-PACKAGE	OUTPUT VOLTAGE (V)
MAX6129_EUK21-T	-40 $^{\circ}$ C to +85 $^{\circ}$ C	5 SOT23-5	2.048
MAX6129AC/D21	-40 $^{\circ}$ C to +85 $^{\circ}$ C	Dice	2.048
MAX6129_EUK25-T	-40 $^{\circ}$ C to +85 $^{\circ}$ C	5 SOT23-5	2.500
MAX6129AC/D25	-40 $^{\circ}$ C to +85 $^{\circ}$ C	Dice	2.500
MAX6129_EUK30-T	-40 $^{\circ}$ C to +85 $^{\circ}$ C	5 SOT23-5	3.000
MAX6129AC/D30	-40 $^{\circ}$ C to +85 $^{\circ}$ C	Dice	3.000
MAX6129_EUK33-T	-40 $^{\circ}$ C to +85 $^{\circ}$ C	5 SOT23-5	3.300
MAX6129AC/D33	-40 $^{\circ}$ C to +85 $^{\circ}$ C	Dice	3.300
MAX6129_EUK41-T	-40 $^{\circ}$ C to +85 $^{\circ}$ C	5 SOT23-5	4.096
MAX6129AC/D41	-40 $^{\circ}$ C to +85 $^{\circ}$ C	Dice	4.096
MAX6129_EUK50-T	-40 $^{\circ}$ C to +85 $^{\circ}$ C	5 SOT23-5	5.000
MAX6129AC/D50	-40 $^{\circ}$ C to +70 $^{\circ}$ C	Dice	5.000

**Note:** The MAX6129\_EUK is available in A or B grade. Choose the desired grade from the Selector Guide and insert the suffix in the blank above to complete the part number.

Selector Guide appears at end of data sheet.

## Pin Configuration

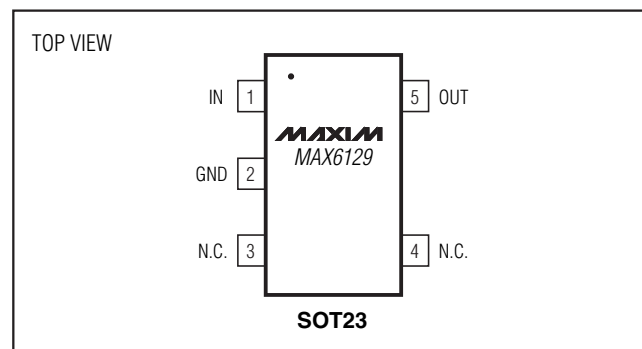

# Ultra-Low-Power Series Voltage Reference

## ABSOLUTE MAXIMUM RATINGS

IN to GND .....-0.3V to +13V  
 OUT to GND .....-0.3V to the lower of +6V and ( $V_{IN} + 0.3V$ )  
 Output to GND Short-Circuit Duration.....Continuous  
 Continuous Power Dissipation ( $T_A = +70^\circ\text{C}$ )  
 5-Pin SOT23 (derate 7.1mW/°C above +70°C).....571mW

Operating Temperature Range .....-40°C to +85°C  
 Storage Temperature Range .....-65°C to +150°C  
 Lead Temperature (soldering, 10s) .....+300°C

Stresses beyond those listed under "Absolute Maximum Ratings" may cause permanent damage to the device. These are stress ratings only, and functional operation of the device at these or any other conditions beyond those indicated in the operational sections of the specifications is not implied. Exposure to absolute maximum rating conditions for extended periods may affect device reliability.

## ELECTRICAL CHARACTERISTICS—MAX6129\_21 ( $V_{OUT} = 2.048V$ )

( $V_{IN} = 2.5V$ ,  $I_{OUT} = 0$ ,  $T_A = T_{MIN}$  to  $T_{MAX}$ , unless otherwise noted. Typical values are at  $T_A = +25^\circ\text{C}$ .) (Note 1)

PARAMETER	SYMBOL	CONDITIONS	MIN	TYP	MAX	UNITS	
<b>OUTPUT</b>							
Output Voltage	$V_{OUT}$	$T_A = +25^\circ\text{C}$	MAX6129A ( $\pm 0.4\%$ )	2.0398	2.0480	2.0562	V
			MAX6129B ( $\pm 1\%$ )	2.0275	2.0480	2.0685	
Output Voltage Temperature Coefficient (Notes 2, 3)	$TCV_{OUT}$	MAX6129A			40	ppm/°C	
		MAX6129B			100		
Line Regulation (Note 4)	$\Delta V_{OUT}/\Delta V_{IN}$	$V_{IN} = 2.5V$ to 12.6V		27	200	$\mu\text{V}/\text{V}$	
Load Regulation (Note 4)	$\Delta V_{OUT}/\Delta I_{OUT}$	$I_{OUT} = 0$ to 4mA		0.22	0.7	$\mu\text{V}/\mu\text{A}$	
		$I_{OUT} = 0$ to -1mA		2.4	5.5		
Output Short-Circuit Current	$I_{SC}$			60		mA	
Long-Term Stability	$\Delta V_{OUT}/\text{time}$	1000 hours at +25°C		150		ppm	
Thermal Hysteresis		(Note 5)		140		ppm	
<b>DYNAMIC CHARACTERISTICS</b>							
Noise Voltage	$e_{OUT}$	$f = 0.1\text{Hz}$ to 10Hz		30		$\mu\text{V}_{P-P}$	
		$f = 10\text{Hz}$ to 1kHz		115		$\mu\text{V}_{RMS}$	
Ripple Rejection	$\Delta V_{OUT}/\Delta V_{IN}$	$V_{IN} = 2.5V \pm 200\text{mV}$ , $f = 120\text{Hz}$		43		dB	
Turn-On Settling Time	$t_R$	$T_o V_{OUT} = 0.1\%$ of final value		450		$\mu\text{s}$	
<b>INPUT</b>							
Supply Voltage Range	$V_{IN}$		2.5		12.6	V	
Supply Current	$I_{IN}$				5.25	$\mu\text{A}$	
Change in Supply Current (Note 4)	$I_{IN}/V_{IN}$	$V_{IN} = 2.5V$ to 12.6V		1.0	1.5	$\mu\text{A}/\text{V}$	

# Ultra-Low-Power Series Voltage Reference

**MAX6129**

## ELECTRICAL CHARACTERISTICS—MAX6129\_25 (V<sub>OUT</sub> = 2.500V)

(V<sub>IN</sub> = 2.7V, I<sub>OUT</sub> = 0, T<sub>A</sub> = T<sub>MIN</sub> to T<sub>MAX</sub>, unless otherwise noted. Typical values are at T<sub>A</sub> = +25°C.) (Note 1)

PARAMETER	SYMBOL	CONDITIONS	MIN	TYP	MAX	UNITS	
<b>OUTPUT</b>							
Output Voltage	V <sub>OUT</sub>	T <sub>A</sub> = +25°C	MAX6129A (±0.4%)	2.4900	2.5000	2.5100	V
			MAX6129B (±1%)	2.4750	2.5000	2.5250	
Output Voltage Temperature Coefficient (Notes 2, 3)	TCV <sub>OUT</sub>	MAX6129A			40	ppm/°C	
		MAX6129B			100		
Line Regulation (Note 4)	ΔV <sub>OUT</sub> /ΔV <sub>IN</sub>	V <sub>IN</sub> = 2.7V to 12.6V		30	230	μV/V	
Load Regulation (Note 4)	ΔV <sub>OUT</sub> /ΔI <sub>OUT</sub>	I <sub>OUT</sub> = 0 to 4mA		0.1	0.6	μV/μA	
		I <sub>OUT</sub> = 0 to -1mA		2.5	6.2		
Dropout Voltage (Notes 4, 6)	V <sub>IN</sub> - V <sub>OUT</sub>	I <sub>OUT</sub> = 0		0.3	100	mV	
		I <sub>OUT</sub> = 4mA		140	200		
Output Short-Circuit Current	I <sub>SC</sub>			60		mA	
Long-Term Stability	ΔV <sub>OUT</sub> /time	1000 hours at +25°C		150		ppm	
Thermal Hysteresis		(Note 5)		140		ppm	
<b>DYNAMIC CHARACTERISTICS</b>							
Noise Voltage	e <sub>OUT</sub>	f = 0.1Hz to 10Hz		39		μV <sub>P-P</sub>	
		f = 10Hz to 1kHz		137		μV <sub>RMS</sub>	
Ripple Rejection	ΔV <sub>OUT</sub> /ΔV <sub>IN</sub>	V <sub>IN</sub> = 2.7V ±200mV, f = 120Hz		34		dB	
Turn-On Settling Time	t <sub>R</sub>	To V <sub>OUT</sub> = 0.1% of final value		700		ms	
<b>INPUT</b>							
Supply Voltage Range	V <sub>IN</sub>		2.7		12.6	V	
Supply Current	I <sub>IN</sub>				5.75	μA	
Change in Supply Current (Note 4)	I <sub>IN</sub> /V <sub>IN</sub>	V <sub>IN</sub> = 2.7V to 12.6V		1.0	1.5	μA/V	

# Ultra-Low-Power Series Voltage Reference

## ELECTRICAL CHARACTERISTICS—MAX6129\_30 (V<sub>OUT</sub> = 3.000V)

(V<sub>IN</sub> = 3.2V, I<sub>OUT</sub> = 0, T<sub>A</sub> = T<sub>MIN</sub> to T<sub>MAX</sub>, unless otherwise noted. Typical values are at T<sub>A</sub> = +25°C.) (Note 1)

PARAMETER	SYMBOL	CONDITIONS	MIN	TYP	MAX	UNITS	
<b>OUTPUT</b>							
Output Voltage	V <sub>OUT</sub>	T <sub>A</sub> = +25°C	MAX6129A (±0.4%)	2.9880	3.0000	3.0120	V
			MAX6129B (±1%)	2.9700	3.0000	3.0300	
Output Voltage Temperature Coefficient (Notes 2, 3)	TCV <sub>OUT</sub>	MAX6129A			40	ppm/°C	
		MAX6129B			100		
Line Regulation (Note 4)	ΔV <sub>OUT</sub> /ΔV <sub>IN</sub>	V <sub>IN</sub> = 3.2V to 12.6V		15	250	μV/V	
Load Regulation (Note 4)	ΔV <sub>OUT</sub> /ΔI <sub>OUT</sub>	I <sub>OUT</sub> = 0 to 4mA		0.1	0.6	μV/μA	
		I <sub>OUT</sub> = 0 to -1mA		2.4	6.5		
Dropout Voltage (Notes 4, 6)	V <sub>IN</sub> - V <sub>OUT</sub>	I <sub>OUT</sub> = 0		0.2	100	mV	
		I <sub>OUT</sub> = 4mA		140	200		
Output Short-Circuit Current	I <sub>SC</sub>			25		mA	
Long-Term Stability	ΔV <sub>OUT</sub> /time	1000 hours at +25°C		150		ppm	
Thermal Hysteresis		(Note 5)		140		ppm	
<b>DYNAMIC CHARACTERISTICS</b>							
Noise Voltage	e <sub>OUT</sub>	f = 0.1Hz to 10Hz		50		μV <sub>P-P</sub>	
		f = 10Hz to 1kHz		161		μV <sub>RMS</sub>	
Ripple Rejection	ΔV <sub>OUT</sub> /ΔV <sub>IN</sub>	V <sub>IN</sub> = 3.2V ±200mV, f = 120Hz		37		dB	
Turn-On Settling Time	t <sub>R</sub>	To V <sub>OUT</sub> = 0.1% of final value		775		μs	
<b>INPUT</b>							
Supply Voltage Range	V <sub>IN</sub>		3.2		12.6	V	
Supply Current	I <sub>IN</sub>				6.75	μA	
Change in Supply Current (Note 4)	I <sub>IN</sub> /V <sub>IN</sub>	V <sub>IN</sub> = 3.2V to 12.6V		1.0	1.5	μA/V	

# Ultra-Low-Power Series Voltage Reference

**MAX6129**

## ELECTRICAL CHARACTERISTICS—MAX6129\_33 (V<sub>OUT</sub> = 3.300V)

(V<sub>IN</sub> = 3.5V, I<sub>OUT</sub> = 0, T<sub>A</sub> = T<sub>MIN</sub> to T<sub>MAX</sub>, unless otherwise noted. Typical values are at T<sub>A</sub> = +25°C.) (Note 1)

PARAMETER	SYMBOL	CONDITIONS	MIN	TYP	MAX	UNITS	
<b>OUTPUT</b>							
Output Voltage	V <sub>OUT</sub>	T <sub>A</sub> = +25°C	MAX6129A (±0.4%)	3.2868	3.3000	3.3132	V
			MAX6129B (±1%)	3.2670	3.3000	3.3330	
Output Voltage Temperature Coefficient (Notes 2, 3)	TCV <sub>OUT</sub>	MAX6129A			40	ppm/°C	
		MAX6129B			100		
Line Regulation (Note 4)	ΔV <sub>OUT</sub> /ΔV <sub>IN</sub>	V <sub>IN</sub> = 3.5V to 12.6V		30	270	μV/V	
Load Regulation (Note 4)	ΔV <sub>OUT</sub> /ΔI <sub>OUT</sub>	I <sub>OUT</sub> = 0 to 4mA		0.1	0.6	μV/μA	
		I <sub>OUT</sub> = 0 to -1mA		2.4	7		
Dropout Voltage (Notes 4, 6)	V <sub>IN</sub> - V <sub>OUT</sub>	I <sub>OUT</sub> = 0		0.2	100	mV	
		I <sub>OUT</sub> = 4mA		140	200		
Output Short-Circuit Current	I <sub>SC</sub>			25		mA	
Long-Term Stability	ΔV <sub>OUT</sub> /time	1000 hours at +25°C		150		ppm	
Thermal Hysteresis		(Note 5)		140		ppm	
<b>DYNAMIC CHARACTERISTICS</b>							
Noise Voltage	e <sub>OUT</sub>	f = 0.1Hz to 10Hz		56		μV <sub>P-P</sub>	
		f = 10Hz to 1kHz		174		μV <sub>RMS</sub>	
Ripple Rejection	ΔV <sub>OUT</sub> /ΔV <sub>IN</sub>	V <sub>IN</sub> = 3.5V ±200mV, f = 120Hz		38		dB	
Turn-On Settling Time	t <sub>R</sub>	T <sub>0</sub> V <sub>OUT</sub> = 0.1% of final value		1		ms	
<b>INPUT</b>							
Supply Voltage Range	V <sub>IN</sub>		3.5		12.6	V	
Supply Current	I <sub>IN</sub>				7.25	μA	
Change in Supply Current (Note 4)	I <sub>IN</sub> /V <sub>IN</sub>	V <sub>IN</sub> = 3.5V to 12.6V		1.0	1.5	μA/V	

# Ultra-Low-Power Series Voltage Reference

## ELECTRICAL CHARACTERISTICS—MAX6129\_41 (V<sub>OUT</sub> = 4.096V)

(V<sub>IN</sub> = 4.3V, I<sub>OUT</sub> = 0, T<sub>A</sub> = T<sub>MIN</sub> to T<sub>MAX</sub>, unless otherwise noted. Typical values are at T<sub>A</sub> = +25°C.) (Note 1)

PARAMETER	SYMBOL	CONDITIONS	MIN	TYP	MAX	UNITS	
<b>OUTPUT</b>							
Output Voltage	V <sub>OUT</sub>	T <sub>A</sub> = +25°C	MAX6129A (±0.4%)	4.0796	4.0960	4.1124	V
			MAX6129B (±1%)	4.0550	4.0960	4.1370	
Output Voltage Temperature Coefficient (Notes 2, 3)	TCV <sub>OUT</sub>	MAX6129A			40	ppm/°C	
		MAX6129B			100		
Line Regulation (Note 4)	ΔV <sub>OUT</sub> /ΔV <sub>IN</sub>	V <sub>IN</sub> = 4.3V to 12.6V		30	310	μV/V	
Load Regulation (Note 4)	ΔV <sub>OUT</sub> /ΔI <sub>OUT</sub>	I <sub>OUT</sub> = 0 to 4mA		0.1	0.6	μV/μA	
		I <sub>OUT</sub> = 0 to -1mA		2.5	8.5		
Dropout Voltage (Notes 4, 6)	V <sub>IN</sub> - V <sub>OUT</sub>	I <sub>OUT</sub> = 0		0.18	100	mV	
		I <sub>OUT</sub> = 4mA		140	200		
Output Short-Circuit Current	I <sub>SC</sub>			25		mA	
Long-Term Stability	ΔV <sub>OUT</sub> /time	1000 hours at +25°C		150		ppm	
Thermal Hysteresis		(Note 5)		140		ppm	
<b>DYNAMIC CHARACTERISTICS</b>							
Noise Voltage	e <sub>OUT</sub>	f = 0.1Hz to 10Hz		72		μV <sub>P-P</sub>	
		f = 10Hz to 1kHz		210		μV <sub>RMS</sub>	
Ripple Rejection	ΔV <sub>OUT</sub> /ΔV <sub>IN</sub>	V <sub>IN</sub> = 4.3V ±200mV, f = 120Hz		36		dB	
Turn-On Settling Time	t <sub>R</sub>	To V <sub>OUT</sub> = 0.1% of final value		1.2		ms	
<b>INPUT</b>							
Supply Voltage Range	V <sub>IN</sub>		4.3		12.6	V	
Supply Current	I <sub>IN</sub>				8.75	μA	
Change in Supply Current (Note 4)	I <sub>IN</sub> /V <sub>IN</sub>	V <sub>IN</sub> = 4.3V to 12.6V		1.0	1.5	μA/V	

# Ultra-Low-Power Series Voltage Reference

MAX6129

## ELECTRICAL CHARACTERISTICS—MAX6129\_50 (V<sub>OUT</sub> = 5.000V)

(V<sub>IN</sub> = 5.2V, I<sub>OUT</sub> = 0, T<sub>A</sub> = T<sub>MIN</sub> to T<sub>MAX</sub>, unless otherwise noted. Typical values are at T<sub>A</sub> = +25°C.) (Note 1)

PARAMETER	SYMBOL	CONDITIONS	MIN	TYP	MAX	UNITS	
<b>OUTPUT</b>							
Output Voltage	V <sub>OUT</sub>	T <sub>A</sub> = +25°C	MAX6129A (±0.4%)	4.9800	5.0000	5.0200	V
			MAX6129B (±1%)	4.9500	5.0000	5.0500	
Output Voltage Temperature Coefficient (Notes 2, 3)	TCV <sub>OUT</sub>	MAX6129A			40	ppm/°C	
		MAX6129B			100		
Line Regulation (Note 4)	ΔV <sub>OUT</sub> /ΔV <sub>IN</sub>	V <sub>IN</sub> = 5.2V to 12.6V		34	375	μV/V	
Load Regulation (Note 4)	ΔV <sub>OUT</sub> /ΔI <sub>OUT</sub>	I <sub>OUT</sub> = 0 to 4mA		0.3	0.8	μV/μA	
		I <sub>OUT</sub> = 0 to -1mA		3.3	9		
Dropout Voltage (Notes 4, 6)	V <sub>IN</sub> - V <sub>OUT</sub>	I <sub>OUT</sub> = 0		0.175	100	mV	
		I <sub>OUT</sub> = 4mA		140	200		
Output Short-Circuit Current	I <sub>SC</sub>			25		mA	
Long-Term Stability	ΔV <sub>OUT</sub> /time	1000 hours at +25°C		150		ppm	
Thermal Hysteresis		(Note 5)		140		ppm	
<b>DYNAMIC CHARACTERISTICS</b>							
Noise Voltage	e <sub>OUT</sub>	f = 0.1Hz to 10Hz		90		μV <sub>P-P</sub>	
		f = 10Hz to 1kHz		245		μV <sub>RMS</sub>	
Ripple Rejection	ΔV <sub>OUT</sub> /ΔV <sub>IN</sub>	V <sub>IN</sub> = 5.2V ±200mV, f = 120Hz		38		dB	
Turn-On Settling Time	t <sub>R</sub>	To V <sub>OUT</sub> = 0.1% of final value		1.4		ms	
<b>INPUT</b>							
Supply Voltage Range	V <sub>IN</sub>		5.2		12.6	V	
Supply Current	I <sub>IN</sub>				10.5	μA	
Change in Supply Current (Note 4)	I <sub>IN</sub> /V <sub>IN</sub>	V <sub>IN</sub> = 5.2V to 12.6V		1.0	1.5	μA/V	

**Note 1:** MAX6129 is 100% production tested at T<sub>A</sub> = +25°C and is guaranteed by design for T<sub>A</sub> = T<sub>MIN</sub> to T<sub>MAX</sub> as specified.

**Note 2:** Temperature coefficient is defined by box method: (V<sub>MAX</sub> - V<sub>MIN</sub>)/(ΔT × V<sub>+25°C</sub>).

**Note 3:** Not production tested. Guaranteed by design for both SOT23 and dice.

**Note 4:** Only the typical values apply to MAX6129A sold in die form (max values apply to packaged parts).

**Note 5:** Thermal hysteresis is defined as the change in output voltage at T<sub>A</sub> = +25°C before and after cycling the device from T<sub>MAX</sub> to T<sub>MIN</sub>.

**Note 6:** Dropout voltage is the minimum input voltage at which V<sub>OUT</sub> changes by 0.1% from V<sub>OUT</sub> at rated V<sub>IN</sub> and is guaranteed by Load Regulation Test.

# Ultra-Low-Power Series Voltage Reference

## Typical Operating Characteristics

( $V_{IN} = 2.5V$  for MAX\_EUK21,  $V_{IN} = 3.2V$  for MAX\_EUK30, and  $V_{IN} = 5.2V$  for MAX\_EUK50,  $I_{OUT} = 0$ ,  $T_A = +25^\circ C$ , unless otherwise noted.)

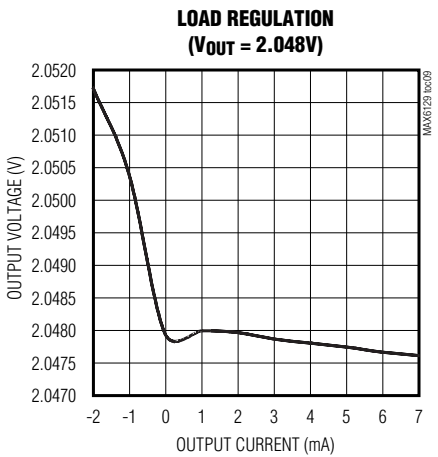
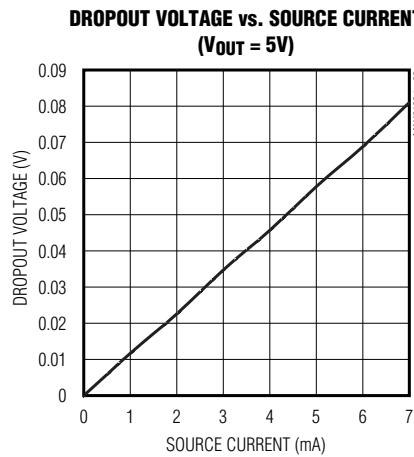
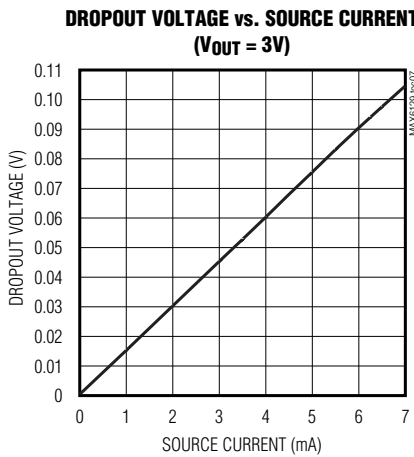
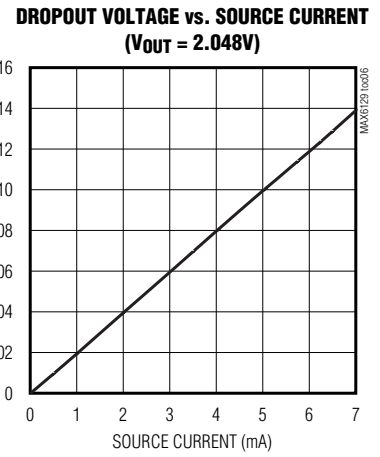
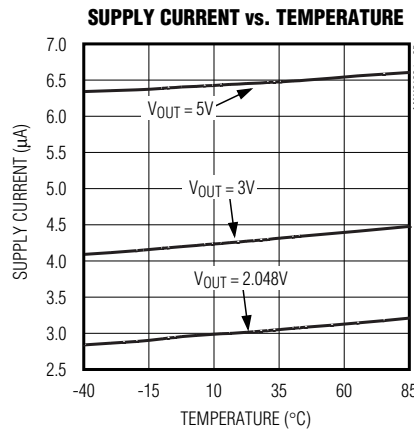
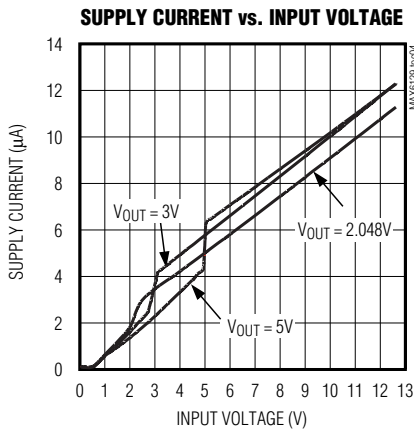
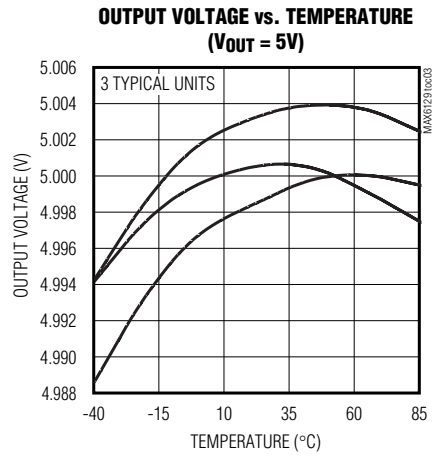
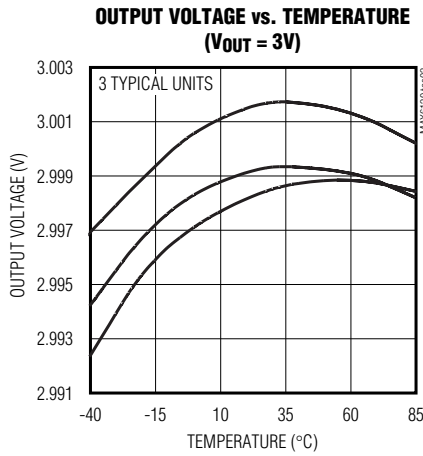
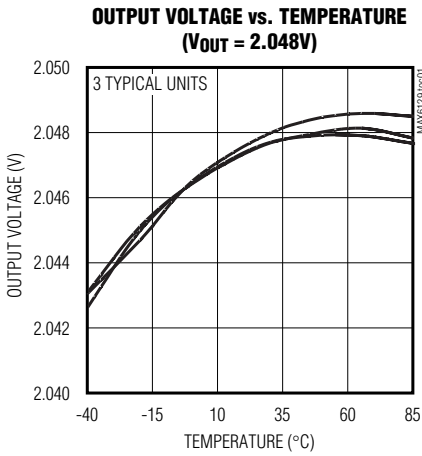

# Ultra-Low-Power Series Voltage Reference

**MAX6129**

## Typical Operating Characteristics (continued)

( $V_{IN} = 2.5V$  for MAX\_EUK21,  $V_{IN} = 3.2V$  for MAX\_EUK30, and  $V_{IN} = 5.2V$  for MAX\_EUK50,  $I_{OUT} = 0$ ,  $T_A = +25^\circ C$ , unless otherwise noted.)

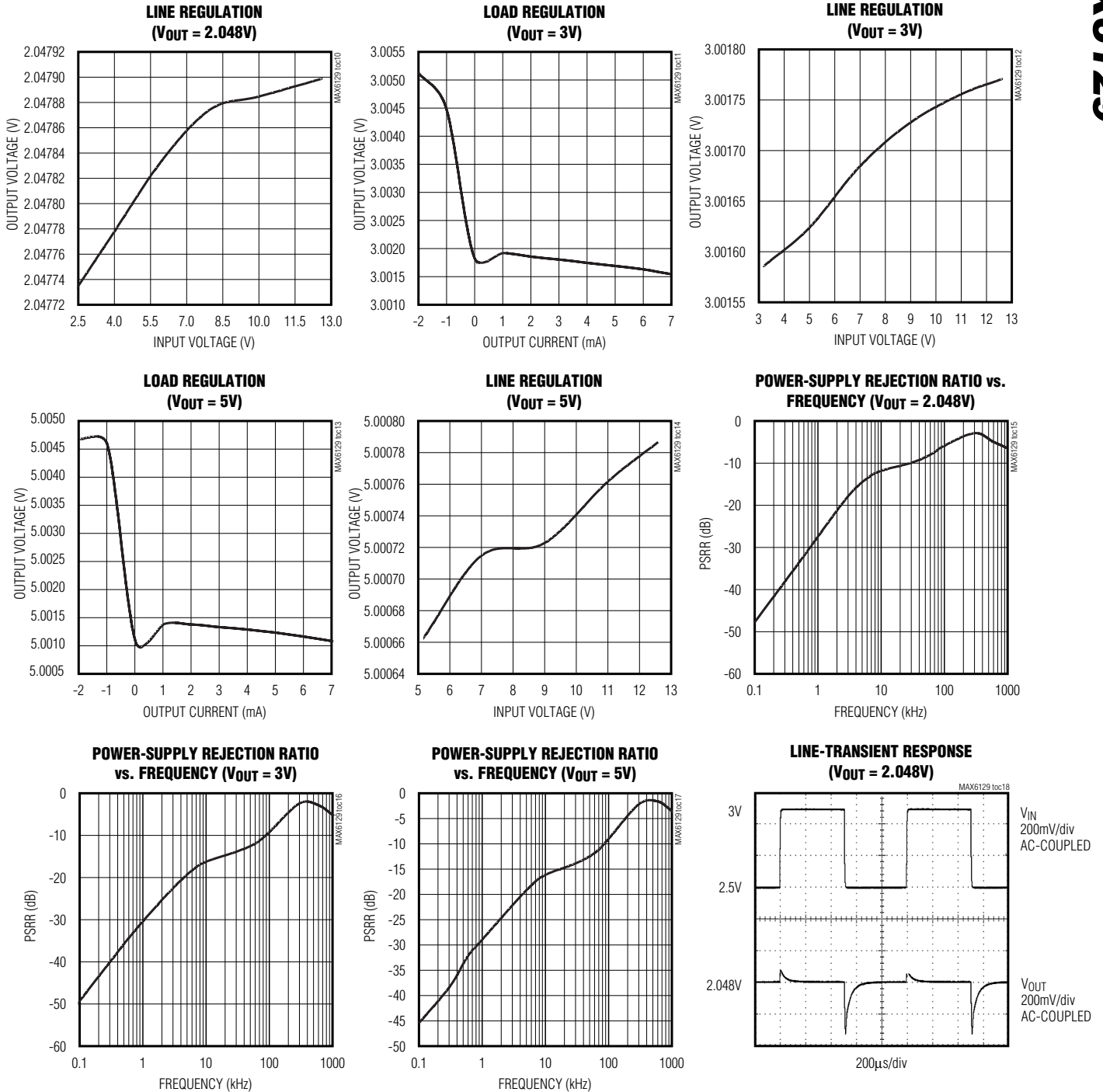

# Ultra-Low-Power Series Voltage Reference

## Typical Operating Characteristics (continued)

( $V_{IN} = 2.5V$  for MAX\_EUK21,  $V_{IN} = 3.2V$  for MAX\_EUK30, and  $V_{IN} = 5.2V$  for MAX\_EUK50,  $I_{OUT} = 0$ ,  $T_A = +25^\circ C$ , unless otherwise noted.)

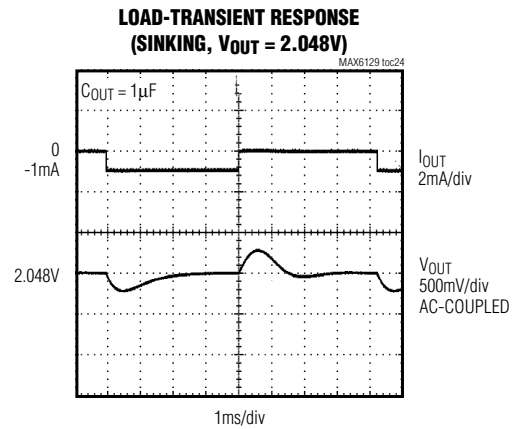
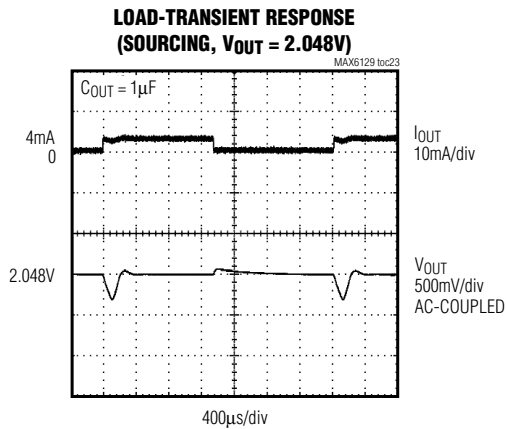
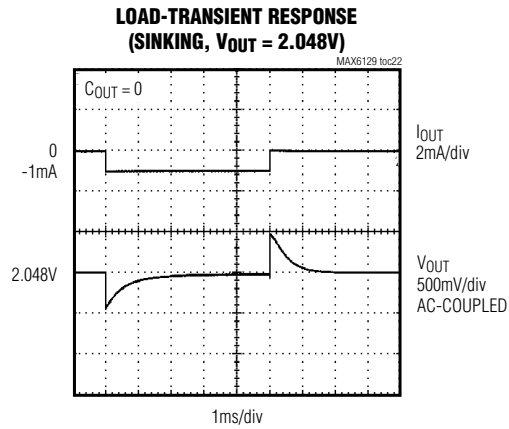
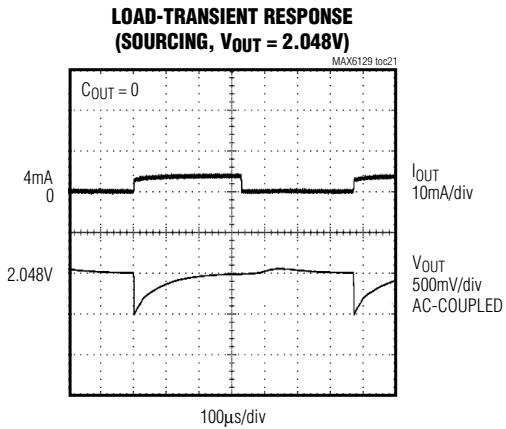
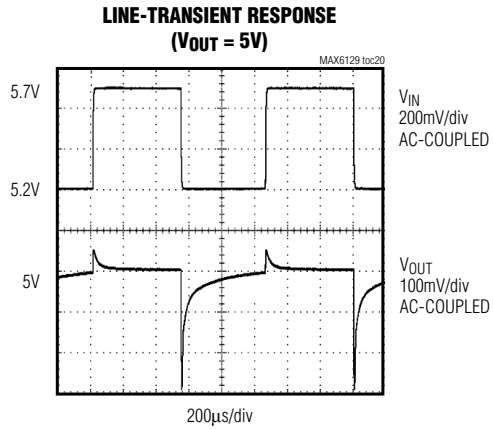
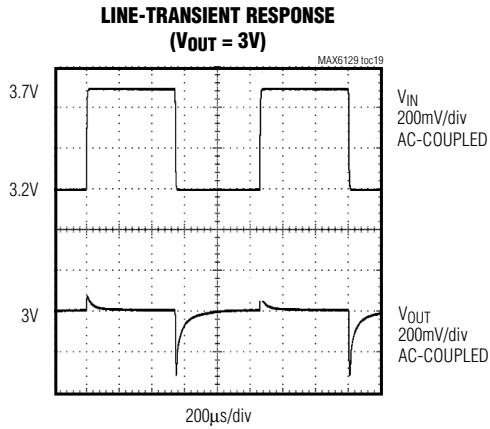

# Ultra-Low-Power Series Voltage Reference

**MAX6129**

## Typical Operating Characteristics (continued)

( $V_{IN} = 2.5V$  for MAX\_EUK21,  $V_{IN} = 3.2V$  for MAX\_EUK30, and  $V_{IN} = 5.2V$  for MAX\_EUK50,  $I_{OUT} = 0$ ,  $T_A = +25^\circ C$ , unless otherwise noted.)

**LOAD-TRANSIENT RESPONSE  
(SOURCING,  $V_{OUT} = 5V$ )**

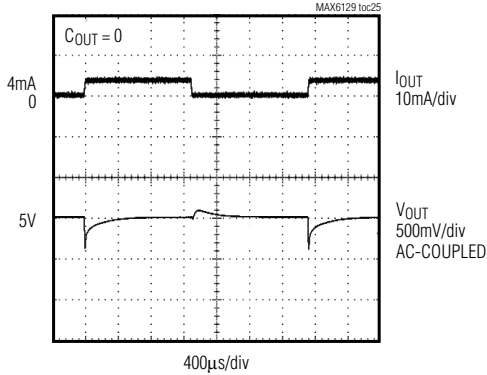

**LOAD-TRANSIENT RESPONSE  
(SINKING,  $V_{OUT} = 5V$ )**

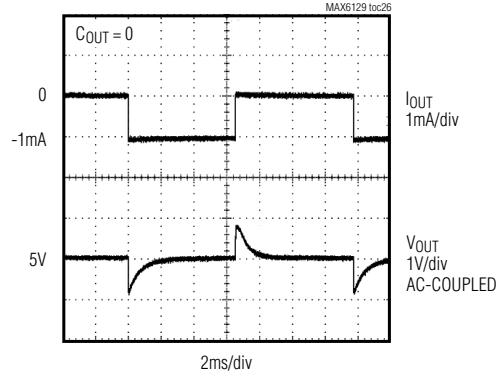

**LOAD-TRANSIENT RESPONSE  
(SOURCING,  $V_{OUT} = 5V$ )**

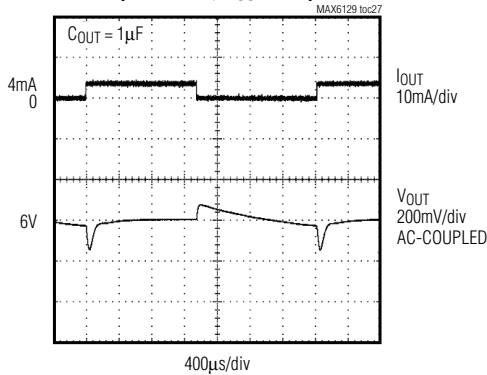

**LOAD-TRANSIENT RESPONSE  
(SINKING,  $V_{OUT} = 5V$ )**

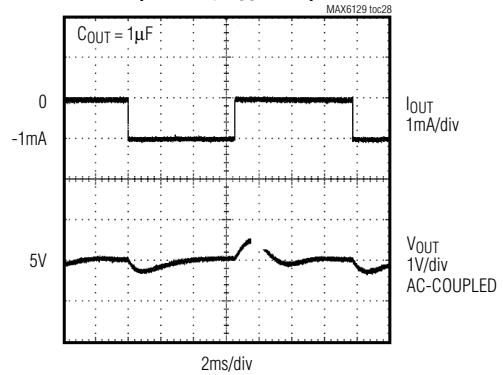

**TURN-ON TRANSIENT  
( $V_{OUT} = 2.048V$ )**

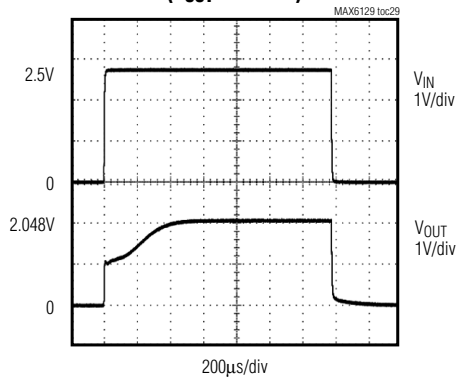

**TURN-ON TRANSIENT  
( $V_{OUT} = 3V$ )**

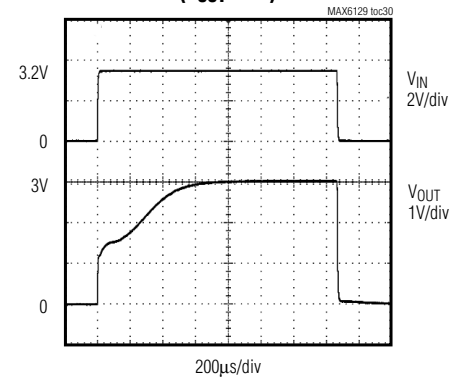

# Ultra-Low-Power Series Voltage Reference

## Typical Operating Characteristics (continued)

( $V_{IN} = 2.5V$  for MAX\_EUK21,  $V_{IN} = 3.2V$  for MAX\_EUK30, and  $V_{IN} = 5.2V$  for MAX\_EUK50,  $I_{OUT} = 0$ ,  $T_A = +25^\circ C$ , unless otherwise noted.)

**TURN-ON TRANSIENT  
( $V_{OUT} = 5V$ )**

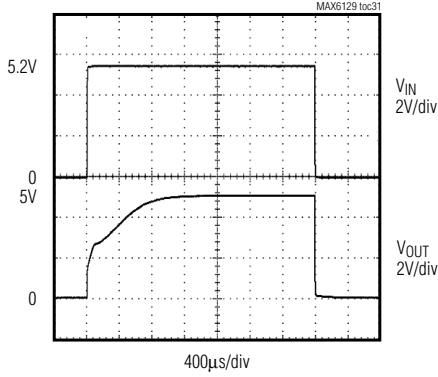

**0.1Hz TO 10Hz OUTPUT NOISE  
( $V_{OUT} = 2.048V$ )**

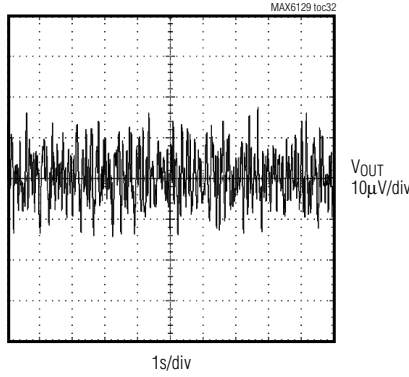

**0.1Hz TO 10Hz OUTPUT NOISE  
( $V_{OUT} = 3V$ )**

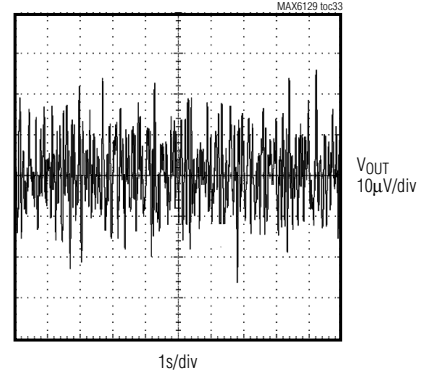

**0.1Hz TO 10Hz OUTPUT NOISE  
( $V_{OUT} = 5V$ )**

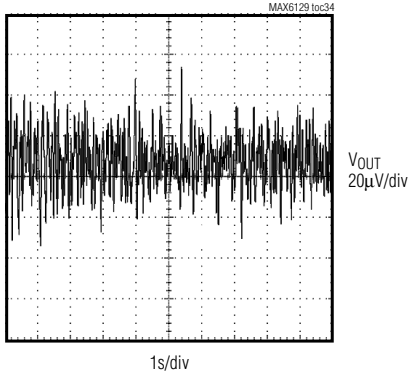

**NOISE vs. FREQUENCY  
( $V_{OUT} = 2.048V$ )**

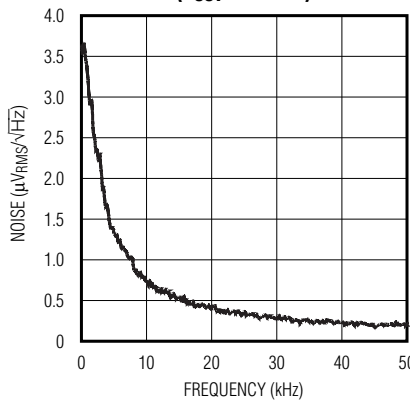

**NOISE vs. FREQUENCY  
( $V_{OUT} = 3V$ )**

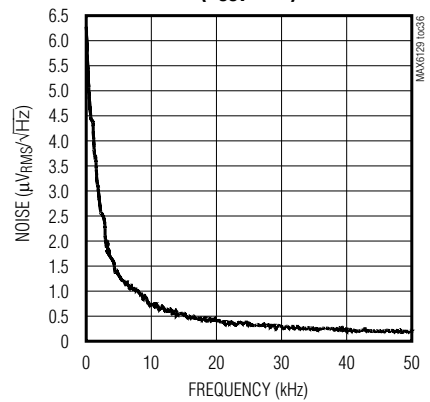

**NOISE vs. FREQUENCY  
( $V_{OUT} = 5V$ )**

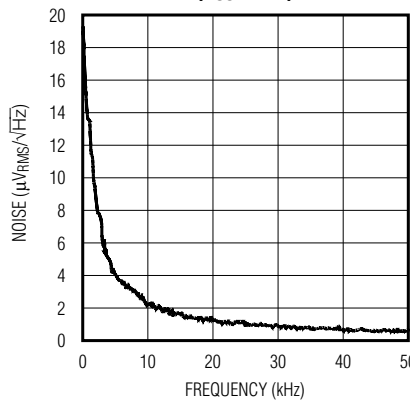

# Ultra-Low-Power Series Voltage Reference

## Pin Description

PIN	NAME	FUNCTION
1	IN	Positive Voltage Supply
2	GND	Ground
3, 4	N.C.	Internally connected. Leave unconnected or connect to ground.
5	OUT	Reference Output

## Applications Information

### Input Bypassing

The MAX6129 does not require an input bypass capacitor. For improved transient performance, bypass the input to ground with a 0.1 $\mu$ F ceramic capacitor. Place the capacitor as close to IN as possible.

### Load Capacitance

The MAX6129 does not require an output capacitor for stability. The MAX6129 is stable driving capacitive loads from 0 to 100pF and 0.1 $\mu$ F to 10 $\mu$ F when sourcing current and from 0 to 0.4 $\mu$ F when sinking current. In applications where the load or the supply can experience step changes, an output capacitor reduces the amount of overshoot (undershoot) and improves the circuit's transient response. Many applications do not require an external capacitor, and the MAX6129 offers a significant advantage in applications where board space is critical.

## Supply Current

The quiescent supply current of the series-mode MAX6129 is very small, 5.25 $\mu$ A (max), and is very stable against changes in the supply voltage with only 1.5 $\mu$ A/V (max) variation with supply voltage. The MAX6129 family draws load current from the input voltage source only when required, so supply current is not wasted and efficiency is maximized at all input voltages. This improved efficiency reduces power dissipation and extends battery life.

## Output Thermal Hysteresis

Output thermal hysteresis is the change of output voltage at  $T_A = +25^\circ\text{C}$  before and after the device is cycled over its entire operating temperature range. Hysteresis is caused by differential package stress appearing across the device.

## Temperature Coefficient vs. Operating Temperature Range for a 1LSB Maximum Error

In a data converter application, the reference voltage of the converter must stay within a certain limit to keep the error in the data converter smaller than the resolution limit through the operating temperature range. Figure 1 shows the maximum allowable reference voltage temperature coefficient to keep the conversion error to less than 1LSB, as a function of the operating temperature range ( $T_{MAX} - T_{MIN}$ ) with the converter resolution as a parameter. The graph assumes the reference-voltage temperature coefficient as the only parameter affecting accuracy.

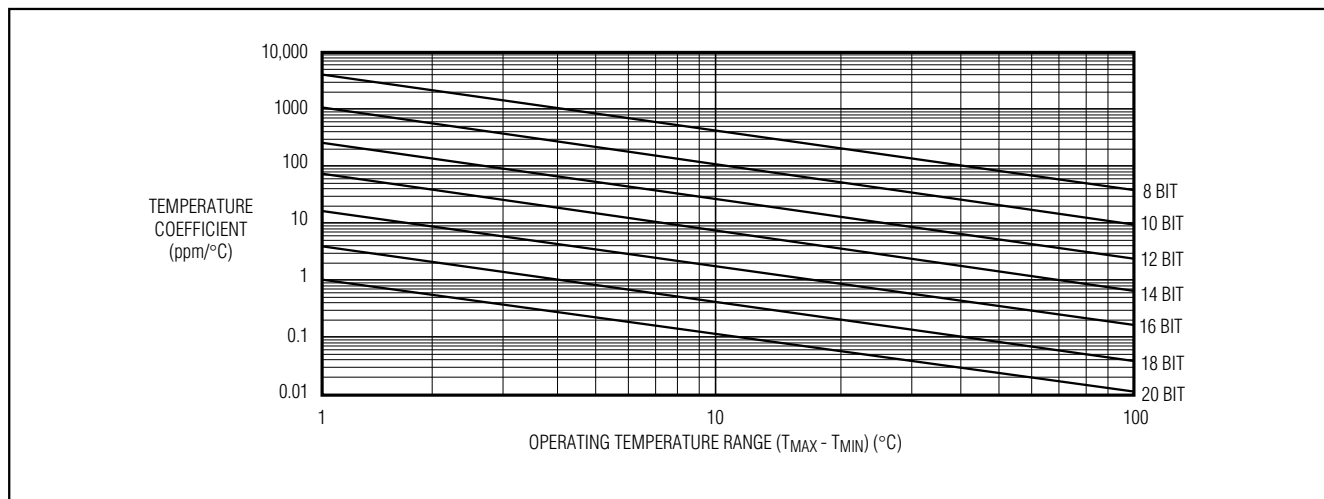

Figure 1. Temperature Coefficient vs. Operating Temperature Range for a 1LSB Maximum Error

## Ultra-Low-Power Series Voltage Reference

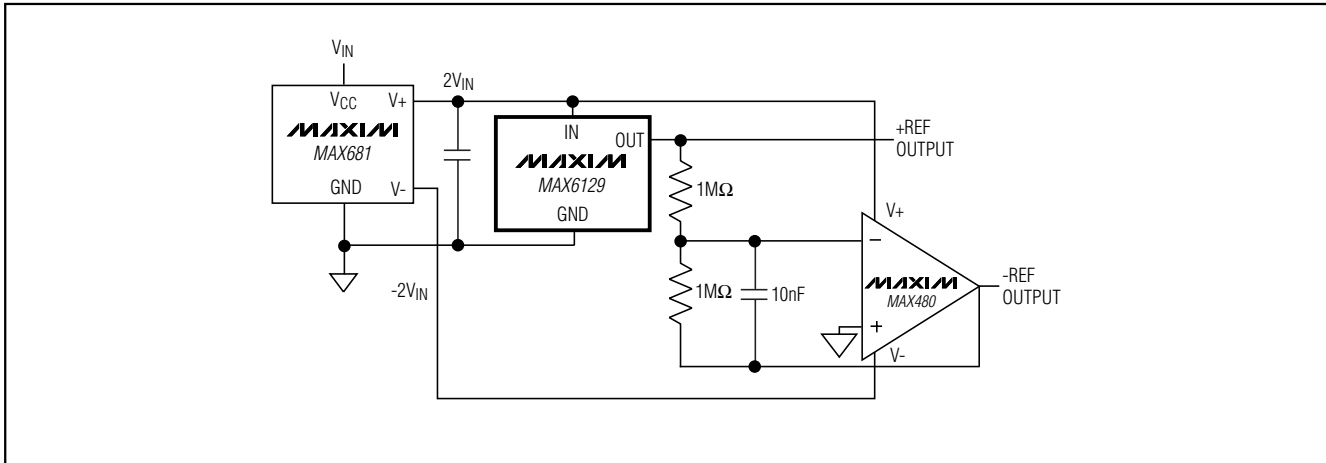

Figure 2. Positive and Negative References from a Single 3V/5V Supply

In reality, the absolute static accuracy of a data converter is dependent on the combination of many parameters such as integral nonlinearity, differential nonlinearity, offset error, gain error, as well as voltage reference changes.

### Turn-On Time

These devices typically turn on and settle to within 0.1% of their final value in less than 1.4ms. The turn-on time increases when heavily loaded and operating close to dropout.

### Positive and Negative Low-Power Voltage Reference

Figure 2 shows a typical method for developing a bipolar reference. The circuit uses a MAX681 voltage doubler/inverter charge-pump converter to power a MAX480, creating a positive as well as a negative reference voltage.

# Ultra-Low-Power Series Voltage Reference

## Selector Guide

**MAX6129**

PART	PIN-PACKAGE	OUTPUT VOLTAGE (V)	INITIAL ACCURACY (%)	TEMPERATURE COEFFICIENT (ppm/°C)	TOP MARK
MAX6129AEUK21-T	5 SOT23-5	2.048	0.4	40	ADRM
MAX6129AC/D21	Dice	2.048	0.4	40	—
MAX6129BEUK21-T	5 SOT23-5	2.048	1	100	ADRN
MAX6129AEUK25-T	5 SOT23-5	2.500	0.4	40	ADRO
MAX6129AC/D25	Dice	2.500	0.4	40	—
MAX6129BEUK25-T*	5 SOT23-5	2.500	1	100	ADRP
MAX6129AEUK30-T	5 SOT23-5	3.000	0.4	40	ADRQ
MAX6129AC/D30	Dice	3.000	0.4	40	—
MAX6129BEUK30-T	5 SOT23-5	3.000	1	100	ADRR
MAX6129AEUK33-T	5 SOT23-5	3.300	0.4	40	ADRW
MAX6129AC/D33	Dice	3.300	0.4	40	—
MAX6129BEUK33-T	5 SOT23-5	3.300	1	100	ADRX
MAX6129AEUK41-T	5 SOT23-5	4.096	0.4	40	ADRS
MAX6129AC/D41	Dice	4.096	0.4	100	—
MAX6129BEUK41-T	5 SOT23-5	4.096	1	100	ADRT
MAX6129AEUK50-T	5 SOT23-5	5.000	0.4	40	ADRU
MAX6129AC/D50	Dice	5.000	0.4	40	—
MAX6129BEUK50-T	5 SOT23-5	5.000	1	100	ADRV

\*Future product—contact factory for availability.

### Chip Topography

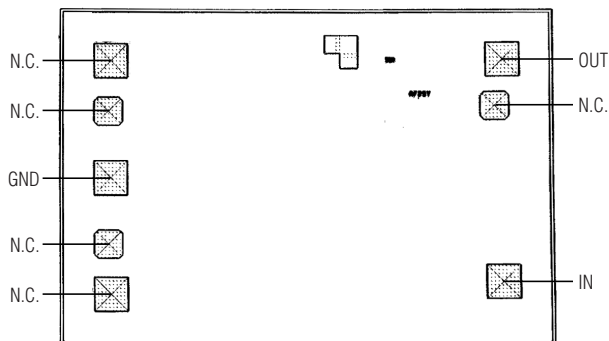

### Chip Information

TRANSISTOR COUNT: 30  
 PROCESS: BiCMOS  
 SUBSTRATE CONNECTED TO GND

# Ultra-Low-Power Series Voltage Reference

## Package Information

(The package drawing(s) in this data sheet may not reflect the most current specifications. For the latest package outline information, go to [www.maxim-ic.com/packages](http://www.maxim-ic.com/packages).)

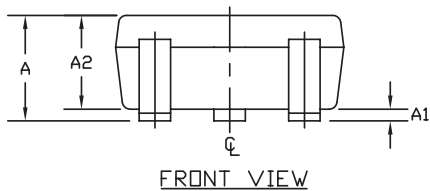
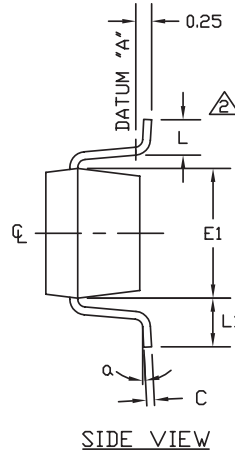
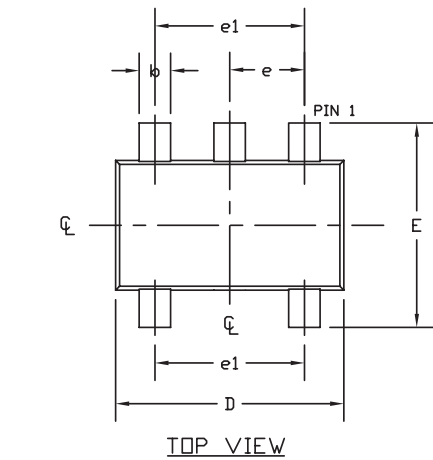

SYMBOL	MIN	MAX
A	0.90	1.45
A1	0.00	0.15
A2	0.90	1.30
b	0.35	0.50
C	0.08	0.20
D	2.80	3.00
E	2.60	3.00
E1	1.50	1.75
L	0.35	0.60
L1	0.60	REF
e	0.95	BSC.
e1	1.90	BSC.
a	0°	8°

- NOTES:
- ALL DIMENSIONS ARE IN MILLIMETERS.
  - FOOT LENGTH MEASURED AT INTERCEPT POINT BETWEEN DATUM A & LEAD SURFACE.
  - PACKAGE OUTLINE EXCLUSIVE OF MOLD FLASH & METAL BURR. MOLD FLASH, PROTRUSION OR METAL BURR SHOULD NOT EXCEED 0.25 MM.
  - PACKAGE OUTLINE INCLUSIVE OF SOLDER PLATING.
  - MEETS JEDEC MO178, VARIATION AA.
  - LEADS TO BE COPLANAR WITHIN 0.10 mm.
  - SOLDER THICKNESS MEASURED AT FLAT SECTION OF LEAD BETWEEN 0.08mm AND 0.15mm FROM LEAD TIP.

PROPRIETARY INFORMATION TITLE: PACKAGE OUTLINE, SOT-23, 5L		
APPROVAL	DOCUMENT CONTROL NO. 21-0057	REV. E 1/1

SOT-23-5L.EPS

Maxim cannot assume responsibility for use of any circuitry other than circuitry entirely embodied in a Maxim product. No circuit patent licenses are implied. Maxim reserves the right to change the circuitry and specifications without notice at any time.

16 Maxim Integrated Products, 120 San Gabriel Drive, Sunnyvale, CA 94086 408-737-7600

## Looking for pricing, stock, or lifecycle information?

Click below to explore more details on WIN SOURCE:

- ⊖ [View MAX6129AEUK50+T on WIN SOURCE](#)
- ⊖ [Maxim Integrated Information](#)

## Optimize Your Supply Chain with WIN SOURCE Solutions

- ✓ Global Sourcing Solution
- ✓ Obsolete Management
- ✓ Cost Control Management
- ✓ Shortage Management
- ✓ Alternative Solution
- ✓ Excess Inventory Management