

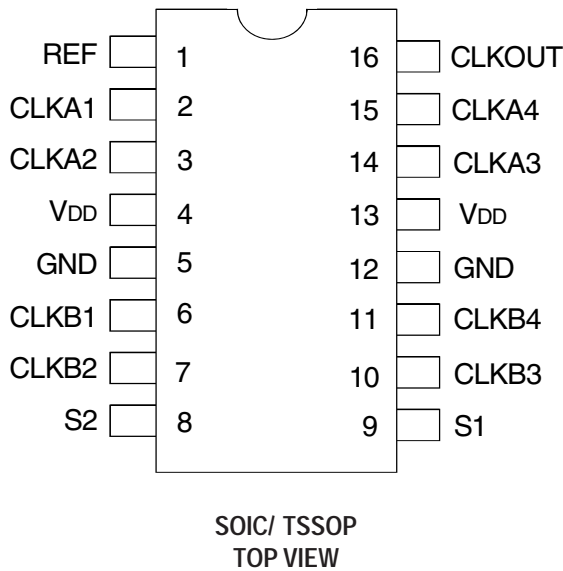

**THE DATASHEET OF
IDT2309B-1HDCGI**



PIN CONFIGURATION



ABSOLUTE MAXIMUM RATINGS⁽¹⁾

| Symbol | Rating | Max. | Unit |
|---|----------------------------------|------------------------------|------|
| V _{DD} | Supply Voltage Range | -0.5 to +4.6 | V |
| V _I ⁽²⁾ | Input Voltage Range (REF) | -0.5 to +5.5 | V |
| V _I | Input Voltage Range (except REF) | -0.5 to V _{DD} +0.5 | V |
| I _{IK} (V _I < 0) | Input Clamp Current | -50 | mA |
| I _O (V _O = 0 to V _{DD}) | Continuous Output Current | ±50 | mA |
| V _{DD} or GND | Continuous Current | ±100 | mA |
| T _A = 55°C (in still air) ⁽³⁾ | Maximum Power Dissipation | 0.7 | W |
| T _{STG} | Storage Temperature Range | -65 to +150 | °C |
| Operating Temperature | Commercial Temperature Range | 0 to +70 | °C |
| Operating Temperature | Industrial Temperature Range | -40 to +85 | °C |

NOTES:

1. Stresses greater than those listed under ABSOLUTE MAXIMUM RATINGS may cause permanent damage to the device. This is a stress rating only and functional operation of the device at these or any other conditions above those indicated in the operational sections of this specification is not implied. Exposure to absolute maximum rating conditions for extended periods may affect reliability.
2. The input and output negative-voltage ratings may be exceeded if the input and output clamp-current ratings are observed.
3. The maximum package power dissipation is calculated using a junction temperature of 150°C and a board trace length of 750 mils.

APPLICATIONS:

- SDRAM
- Telecom
- Datacom
- PC Motherboards/Workstations
- Critical Path Delay Designs

PIN DESCRIPTION

| Pin Name | Pin Number | Type | Functional Description |
|-----------------------|------------|------|--|
| REF | 1 | IN | Input reference clock, 5 Volt tolerant input |
| CLKA1 ⁽¹⁾ | 2 | Out | Output clock for bank A |
| CLKA2 ⁽¹⁾ | 3 | Out | Output clock for bank A |
| V _{DD} | 4, 13 | PWR | 3.3V Supply |
| GND | 5, 12 | GND | Ground |
| CLKB1 ⁽¹⁾ | 6 | Out | Output clock for bank B |
| CLKB2 ⁽¹⁾ | 7 | Out | Output clock for bank B |
| S2 ⁽²⁾ | 8 | IN | Select input Bit 2 |
| S1 ⁽²⁾ | 9 | IN | Select input Bit 1 |
| CLKB3 ⁽¹⁾ | 10 | Out | Output clock for bank B |
| CLKB4 ⁽¹⁾ | 11 | Out | Output clock for bank B |
| CLKA3 ⁽¹⁾ | 14 | Out | Output clock for bank A |
| CLKA4 ⁽¹⁾ | 15 | Out | Output clock for bank A |
| CLKOUT ⁽¹⁾ | 16 | Out | Output clock, internal feedback on this pin |

NOTES:

1. Weak pull down on all outputs.
2. Weak pull ups on these inputs.

FUNCTION TABLE(1)

| S2 | S1 | CLKA | CLKB | CLKOUT ⁽²⁾ | Output Source | PLL Shut Down |
|----|----|-----------|-----------|-----------------------|---------------|---------------|
| L | L | Tri-State | Tri-State | Driven | PLL | N |
| L | H | Driven | Tri-State | Driven | PLL | N |
| H | L | Driven | Driven | Driven | REF | Y |
| H | H | Driven | Driven | Driven | PLL | N |

NOTES:

- H = HIGH Voltage Level.
L = LOW Voltage Level
- This output is driven and has an internal feedback for the PLL. The load on this output can be adjusted to change the skew between the REF and the output.

DC ELECTRICAL CHARACTERISTICS - COMMERCIAL

| Symbol | Parameter | Conditions | | Min. | Max. | Unit |
|--------------------|--------------------------|--|-------------------------------|------|------|------|
| V _{IL} | Input LOW Voltage Level | | | — | 0.8 | V |
| V _{IH} | Input HIGH Voltage Level | | | 2 | — | V |
| I _{IL} | Input LOW Current | V _{IN} = 0V | | — | 50 | μA |
| I _{IH} | Input HIGH Current | V _{IN} = V _{DD} | | — | 100 | μA |
| V _{OL} | Output LOW Voltage | Standard Drive | I _{OL} = 8mA | — | 0.4 | V |
| | | High Drive | I _{OL} = 12mA (-1H) | | | |
| V _{OH} | Output HIGH Voltage | Standard Drive | I _{OH} = -8mA | 2.4 | — | V |
| | | High Drive | I _{OH} = -12mA (-1H) | | | |
| I _{DD_PD} | Power Down Current | REF = 0MHz (S2 = S1 = H) | | — | 12 | μA |
| I _{DD} | Supply Current | Unloaded Outputs at 66.66MHz, SEL inputs at V _{DD} or GND | | — | 32 | mA |

OPERATING CONDITIONS - COMMERCIAL

| Symbol | Parameter | Min. | Max. | Unit |
|-----------------|---|------|------|------|
| V _{DD} | Supply Voltage | 3 | 3.6 | V |
| T _A | Operating Temperature (Ambient Temperature) | 0 | 70 | °C |
| C _L | Load Capacitance < 100MHz | — | 30 | pF |
| | Load Capacitance 100MHz - 133MHz | — | 10 | |
| C _{IN} | Input Capacitance | — | 7 | pF |

SWITCHING CHARACTERISTICS (2309B-1) - COMMERCIAL^(1,2)

| Symbol | Parameter | Conditions | Min. | Typ. | Max. | Unit |
|-------------------|---|---|------|------|------|------|
| t _f | Output Frequency | 10pF Load | 10 | — | 133 | MHz |
| | | 30pF Load | 10 | — | 100 | |
| | Duty Cycle = t ₂ ÷ t ₁ | Measured at 1.4V, F _{OUT} = 66.66MHz | 40 | 50 | 60 | % |
| t ₃ | Rise Time | Measured between 0.8V and 2V | — | — | 2.5 | ns |
| t ₄ | Fall Time | Measured between 0.8V and 2V | — | — | 2.5 | ns |
| t ₅ | Output to Output Skew | All outputs equally loaded | — | — | 250 | ps |
| t _{6A} | Delay, REF Rising Edge to CLKOUT Rising Edge ⁽²⁾ | Measured at V _{DD} /2 | — | 0 | ±350 | ps |
| t _{6B} | Delay, REF Rising Edge to CLKOUT Rising Edge ⁽²⁾ | Measured at V _{DD} /2 in PLL bypass mode (IDT2309B only) | 1 | 5 | 8.7 | ns |
| t ₇ | Device-to-Device Skew | Measured at V _{DD} /2 on the CLKOUT pins of devices | — | 0 | 700 | ps |
| t ₁ | Cycle-to-Cycle Jitter | Measured at 66.66MHz, loaded outputs | — | 50 | 175 | ps |
| t _{LOCK} | PLL Lock Time | Stable power supply, valid clock presented on REF pin | — | — | 1 | ms |

NOTES:

- REF Input has a threshold voltage of V_{DD}/2.
- All parameters specified with loaded outputs.

SWITCHING CHARACTERISTICS (2309B-1H) - COMMERCIAL ^(1,2)

| Symbol | Parameter | Conditions | Min. | Typ. | Max. | Unit |
|-------------------|--|--|------|------|------|------|
| t _l | Output Frequency | 10pF Load | 10 | — | 133 | MHz |
| | | 30pF Load | 10 | — | 100 | |
| | Duty Cycle = t ₂ ÷ t ₁ | Measured at 1.4V, F _{OUT} = 66.66MHz | 40 | 50 | 60 | % |
| | Duty Cycle = t ₂ ÷ t ₁ | Measured at 1.4V, F _{OUT} <50MHz | 45 | 50 | 55 | % |
| t _r | Rise Time | Measured between 0.8V and 2V | — | — | 1.5 | ns |
| t _f | Fall Time | Measured between 0.8V and 2V | — | — | 1.5 | ns |
| t _s | Output to Output Skew | All outputs equally loaded | — | — | 250 | ps |
| t _{6A} | Delay, REF Rising Edge to CLKOUT Rising Edge | Measured at V _{DD} /2 | — | 0 | ±350 | ps |
| t _{6B} | Delay, REF Rising Edge to CLKOUT Rising Edge | Measured at V _{DD} /2 in PLL bypass mode (IDT2309 only) | 1 | 5 | 8.7 | ns |
| t ₇ | Device-to-Device Skew | Measured at V _{DD} /2 on the CLKOUT pins of devices | — | 0 | 700 | ps |
| t _s | Output Slew Rate | Measured between 0.8V and 2V using Test Circuit 2 | 1 | — | — | V/ns |
| t _j | Cycle-to-Cycle Jitter | Measured at 66.66MHz, loaded outputs | — | — | 175 | ps |
| t _{LOCK} | PLL Lock Time | Stable power supply, valid clock presented on REF pin | — | — | 1 | ms |

NOTES:

1. REF Input has a threshold voltage of V_{DD}/2.
2. All parameters specified with loaded outputs.

DC ELECTRICAL CHARACTERISTICS - INDUSTRIAL

| Symbol | Parameter | Conditions | Min. | Max. | Unit |
|--------------------|--------------------------|--|------|------|------|
| V _{IL} | Input LOW Voltage Level | | — | 0.8 | V |
| V _{IH} | Input HIGH Voltage Level | | 2 | — | V |
| I _{IL} | Input LOW Current | V _{IN} = 0V | — | 50 | μA |
| I _{IH} | Input HIGH Current | V _{IN} = V _{DD} | — | 100 | μA |
| V _{OL} | Output LOW Voltage | Standard Drive | — | 0.4 | V |
| | | High Drive | | | |
| V _{OH} | Output HIGH Voltage | Standard Drive | 2.4 | — | V |
| | | High Drive | | | |
| I _{DD_PD} | Power Down Current | REF = 0MHz (S ₂ = S ₁ = H) | — | 25 | μA |
| I _{DD} | Supply Current | Unloaded Outputs at 66.66MHz, SEL inputs at V _{DD} or GND | — | 35 | mA |

OPERATING CONDITIONS - INDUSTRIAL

| Symbol | Parameter | Min. | Max. | Unit |
|-----------------|---|------|------|------|
| V _{DD} | Supply Voltage | 3 | 3.6 | V |
| T _A | Operating Temperature (Ambient Temperature) | -40 | +85 | °C |
| C _L | Load Capacitance < 100MHz | — | 30 | pF |
| | Load Capacitance 100MHz - 133MHz | — | 10 | |
| C _{IN} | Input Capacitance | — | 7 | pF |

SWITCHING CHARACTERISTICS (2309B-1) - INDUSTRIAL ^(1,2)

| Symbol | Parameter | Conditions | Min. | Typ. | Max. | Unit |
|-------------------|--|---|------|------|------|------|
| t ₁ | Output Frequency | 10pF Load | 10 | — | 133 | MHz |
| | | 30pF Load | 10 | — | 100 | |
| | Duty Cycle = t ₂ ÷ t ₁ | Measured at 1.4V, F _{OUT} = 66.66MHz | 40 | 50 | 60 | % |
| t ₃ | Rise Time | Measured between 0.8V and 2V | — | — | 2.5 | ns |
| t ₄ | Fall Time | Measured between 0.8V and 2V | — | — | 2.5 | ns |
| t ₅ | Output to Output Skew | All outputs equally loaded | — | — | 250 | ps |
| t _{6A} | Delay, REF Rising Edge to CLKOUT Rising Edge | Measured at V _{DD} /2 | — | 0 | ±350 | ps |
| t _{6B} | Delay, REF Rising Edge to CLKOUT Rising Edge | Measured at V _{DD} /2 in PLL bypass mode (IDT2309B only) | 1 | 5 | 8.7 | ns |
| t ₇ | Device-to-Device Skew | Measured at V _{DD} /2 on the CLKOUT pins of devices | — | 0 | 700 | ps |
| t ₁ | Cycle-to-Cycle Jitter | Measured at 66.66MHz, loaded outputs | — | 50 | 175 | ps |
| t _{LOCK} | PLL Lock Time | Stable power supply, valid clock presented on REF pin | — | — | 1 | ms |

NOTES:

- REF Input has a threshold voltage of V_{DD}/2.
- All parameters specified with loaded outputs.

SWITCHING CHARACTERISTICS (2309B-1H) - INDUSTRIAL ^(1,2)

| Symbol | Parameter | Conditions | Min. | Typ. | Max. | Unit |
|-------------------|--|---|------|------|------|------|
| t ₁ | Output Frequency | 10pF Load | 10 | — | 133 | MHz |
| | | 30pF Load | 10 | — | 100 | |
| | Duty Cycle = t ₂ ÷ t ₁ | Measured at 1.4V, F _{OUT} = 66.66MHz | 40 | 50 | 60 | % |
| | Duty Cycle = t ₂ ÷ t ₁ | Measured at 1.4V, F _{OUT} < 50MHz | 45 | 50 | 55 | % |
| t ₃ | Rise Time | Measured between 0.8V and 2V | — | — | 1.5 | ns |
| t ₄ | Fall Time | Measured between 0.8V and 2V | — | — | 1.5 | ns |
| t ₅ | Output to Output Skew | All outputs equally loaded | — | — | 250 | ps |
| t _{6A} | Delay, REF Rising Edge to CLKOUT Rising Edge | Measured at V _{DD} /2 | — | 0 | ±350 | ps |
| t _{6B} | Delay, REF Rising Edge to CLKOUT Rising Edge | Measured at V _{DD} /2 in PLL bypass mode (IDT2309B only) | 1 | 5 | 8.7 | ns |
| t ₇ | Device-to-Device Skew | Measured at V _{DD} /2 on the CLKOUT pins of devices | — | 0 | 700 | ps |
| t ₈ | Output Slew Rate | Measured between 0.8V and 2V using Test Circuit 2 | 1 | — | — | V/ns |
| t ₁ | Cycle-to-Cycle Jitter | Measured at 66.66MHz, loaded outputs | — | — | 175 | ps |
| t _{LOCK} | PLL Lock Time | Stable power supply, valid clock presented on REF pin | — | — | 1 | ms |

NOTES:

- REF Input has a threshold voltage of V_{DD}/2.
- All parameters specified with loaded outputs.

ZERO DELAY AND SKEW CONTROL

All outputs should be uniformly loaded in order to achieve Zero I/O Delay. Since the CLKOUT pin is the internal feedback for the PLL, its relative loading can affect and adjust the input/output delay. The Output Load Difference diagram illustrates the PLL's relative loading with respect to the other outputs that can adjust the Input-Output (I/O) Delay.

For designs utilizing zero I/O Delay, all outputs including CLKOUT must be equally loaded. Even if the output is not used, it must have a capacitive load equal to that on the other outputs in order to obtain true zero I/O Delay. If I/O Delay adjustments are needed, use the Output Load Difference diagram to calculate loading differences between the CLKOUT pin and other outputs. For zero output-to-output skew, all outputs must be loaded equally.

REF TO CLKA/CLKB RELAY vs. OUTPUT LOAD DIFFERENCE BETWEEN CLKOUT PIN AND CLKA/CLKB PINS

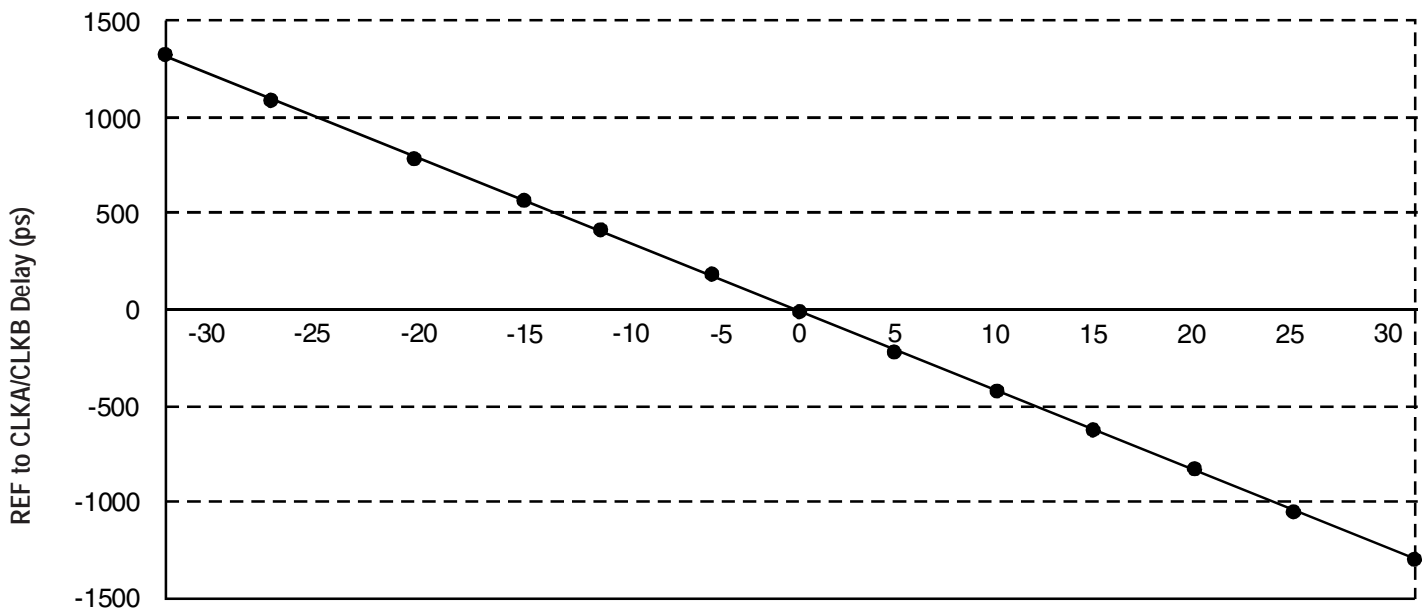

OUTPUT LOAD DIFFERENCE BETWEEN CLKOUT PIN AND CLKA/CLKB PINS (pF)

SWITCHING WAVEFORMS

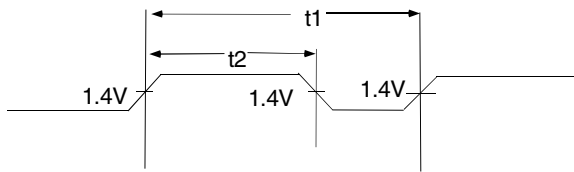

Duty Cycle Timing

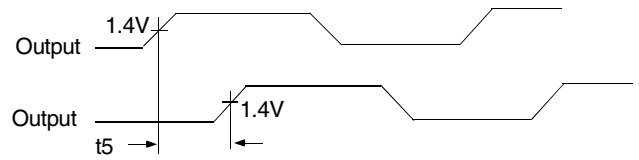

Output to Output Skew

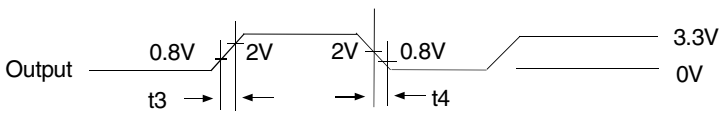

All Outputs Rise/Fall Time

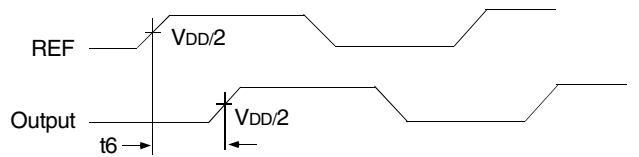

Input to Output Propagation Delay

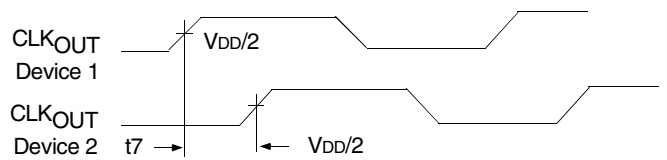

Device to Device Skew

TEST CIRCUITS

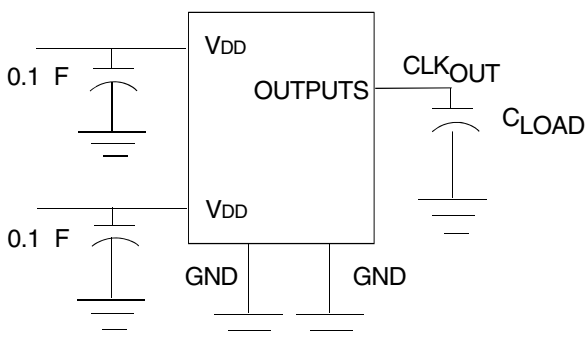

Test Circuit 1 (all Parameters Except t8)

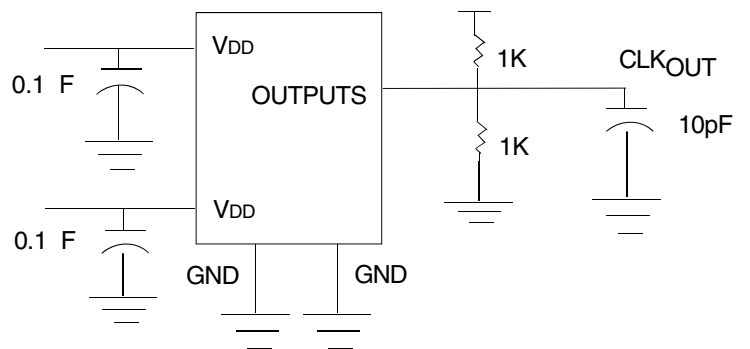

Test Circuit 2 (t8, Output Slew Rate On -1H Devices)

TYPICAL DUTY CYCLE⁽¹⁾ AND I_{DD} TRENDS⁽²⁾ FOR IDT2309B-1

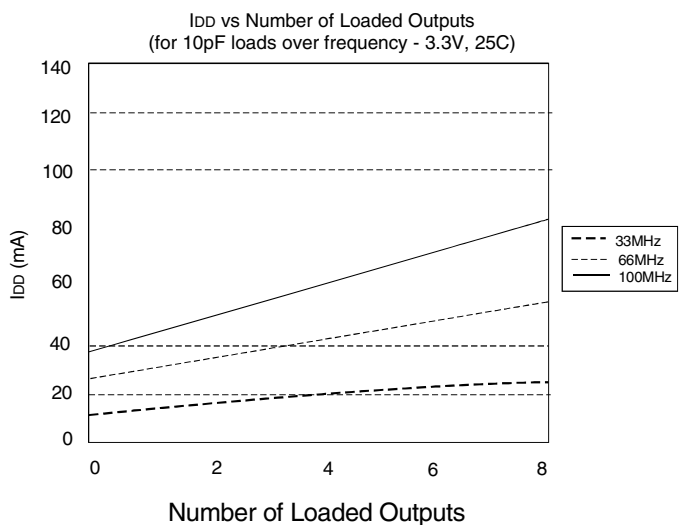
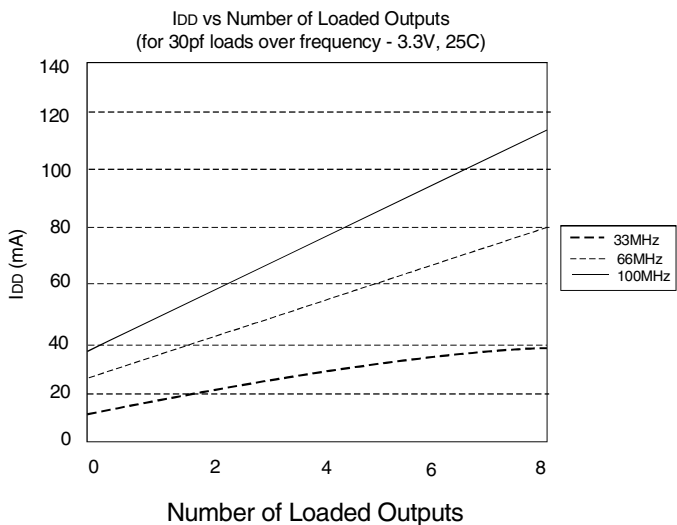
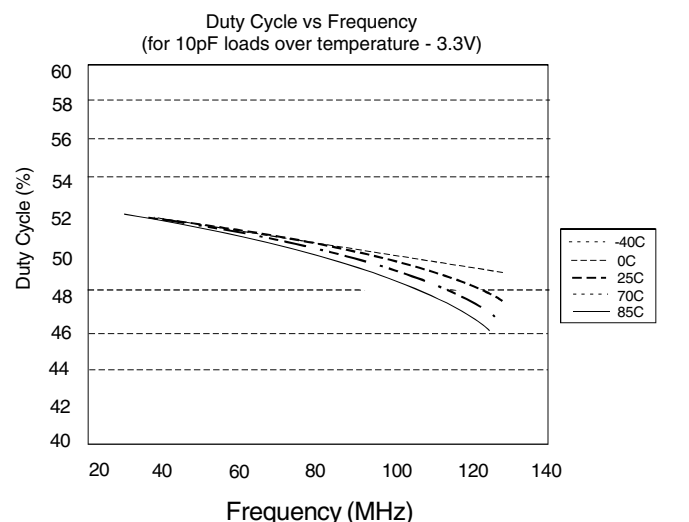
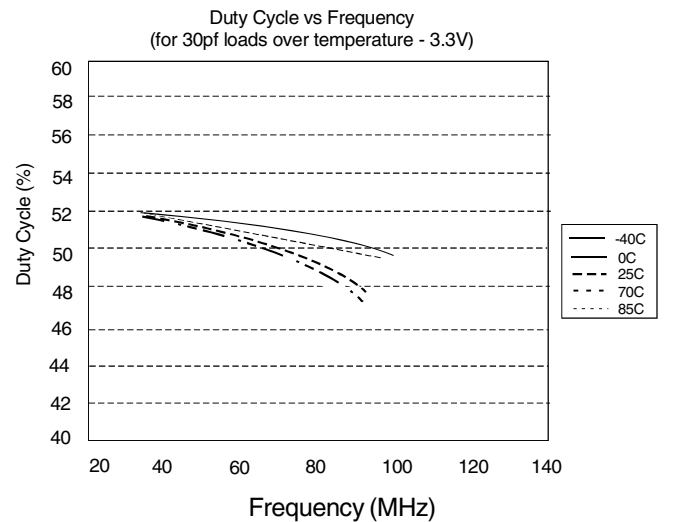
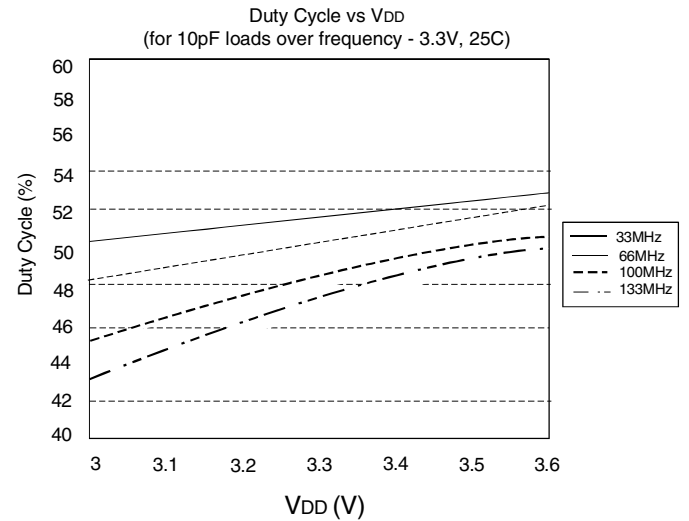
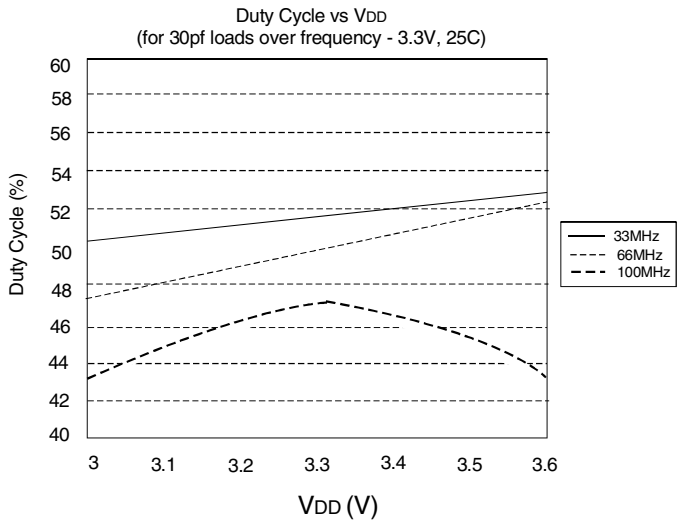

NOTES:

- Duty Cycle is taken from typical chip measured at 1.4V.
- I_{DD} data is calculated from $I_{DD} = I_{CORE} + nCVf$, where I_{CORE} is the unloaded current. (n = Number of outputs; C = Capacitance load per output (F); V = Supply Voltage (V); f = Frequency (Hz))

TYPICAL DUTY CYCLE⁽¹⁾ AND I_{DD} TRENDS⁽²⁾ FOR IDT2309B-1H

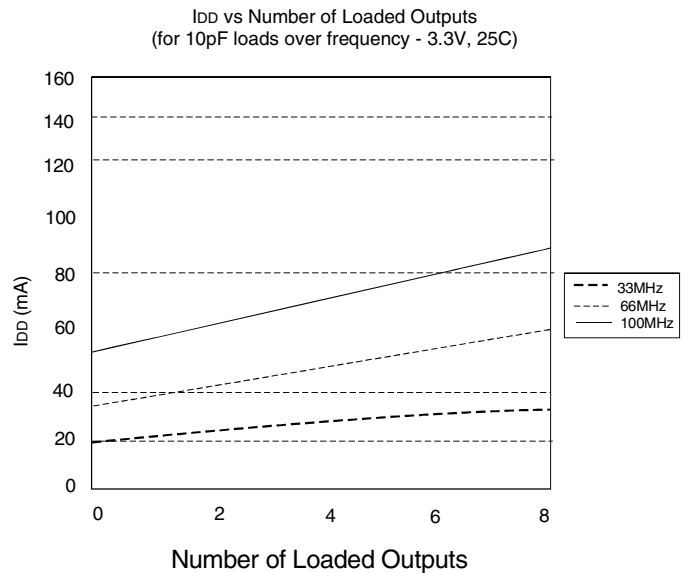
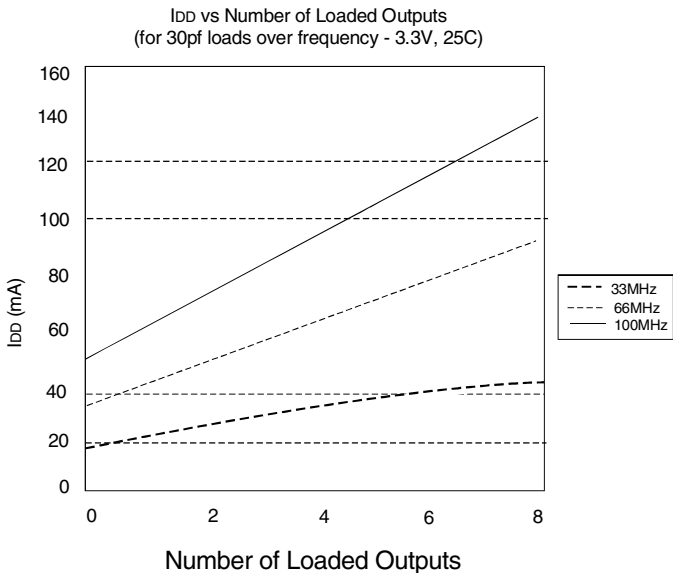
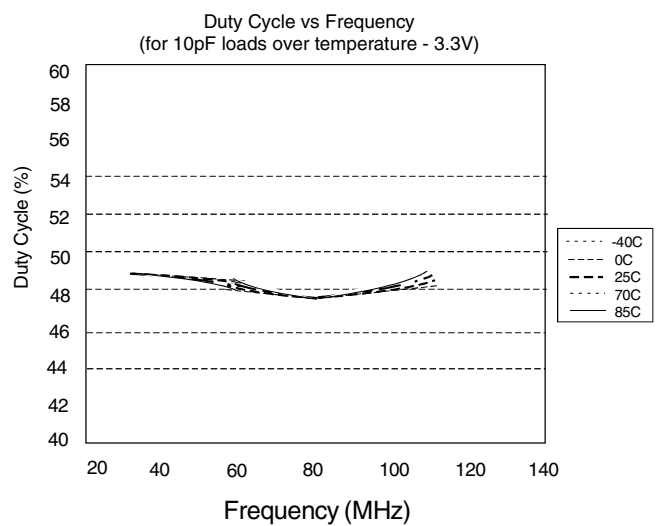
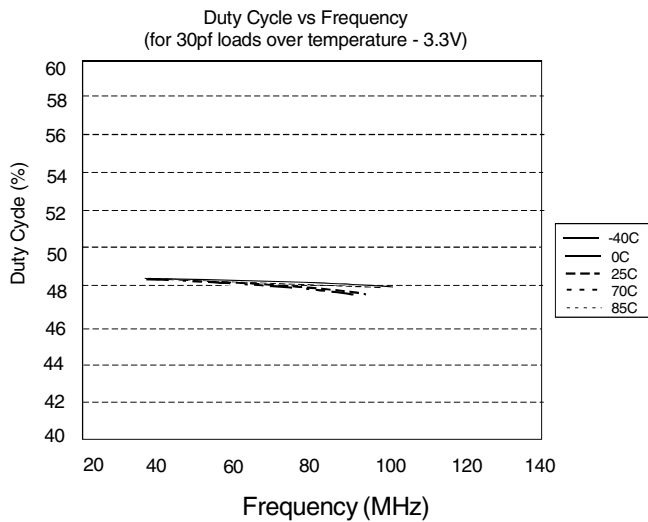
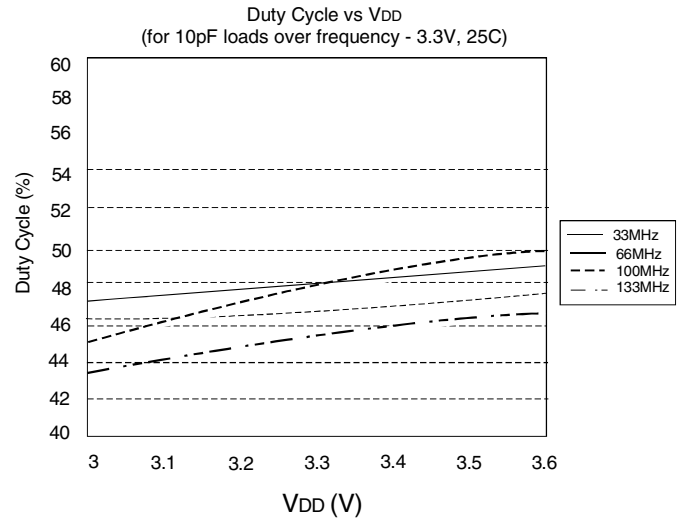
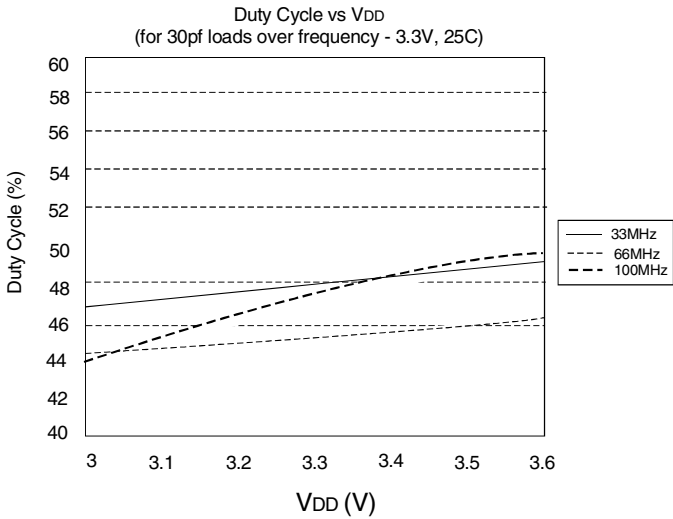

NOTES:

- Duty Cycle is taken from typical chip measured at 1.4V.
- I_{DD} data is calculated from $I_{DD} = I_{CORE} + nCfV$, where I_{CORE} is the unloaded current. (n = Number of outputs; C = Capacitance load per output (F); V = Supply Voltage (V); f = Frequency (Hz))

ORDERING INFORMATION

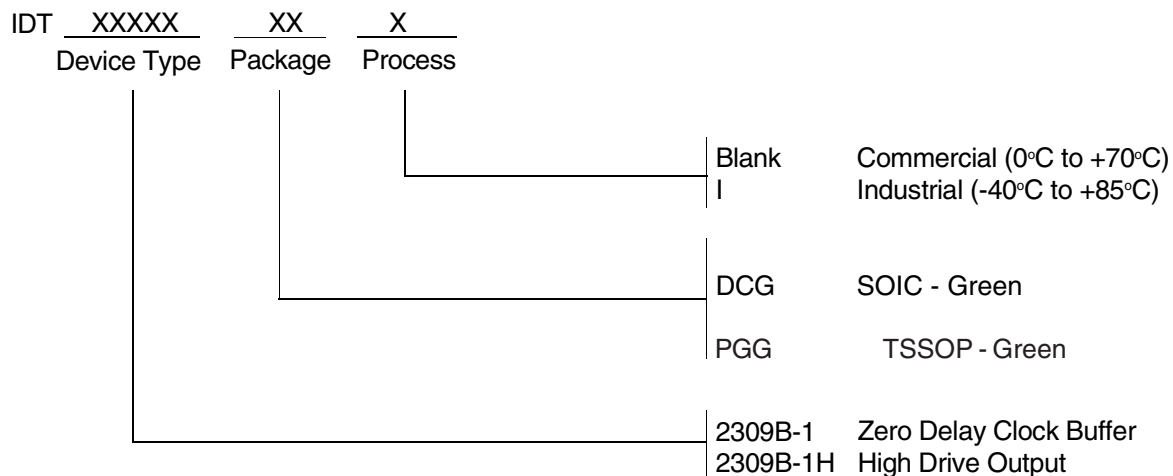

| Ordering Code | Package Type | Operating Range |
|-----------------|--------------|-----------------|
| IDT2309B-1DCG | 16-Pin SOIC | Commercial |
| IDT2309B-1DCGI | 16-Pin SOIC | Industrial |
| IDT2309B-1HDCG | 16-Pin SOIC | Commercial |
| IDT2309B-1HDCGI | 16-Pin SOIC | Industrial |
| IDT2309B-1HPGGI | 16-Pin TSSOP | Industrial |
| IDT2309B-1HPGG | 16-Pin TSSOP | Commercial |



CORPORATE HEADQUARTERS
 6024 Silver Creek Valley Road
 San Jose, CA 95138

for SALES:
 800-345-7015 or 408-284-8200
 fax: 408-284-2775
 www.idt.com

for Tech Support:
 clockhelp@idt.com

Looking for pricing, stock, or lifecycle information?

Click below to explore more details on WIN SOURCE:

- [⊖ View IDT2309B-1HDCGI on WIN SOURCE](#)
- [⊖ IDT, Integrated Device Technology Inc Information](#)

Optimize Your Supply Chain with WIN SOURCE Solutions

- ✓ Global Sourcing Solution
- ✓ Obsolete Management
- ✓ Cost Control Management
- ✓ Shortage Management
- ✓ Alternative Solution
- ✓ Excess Inventory Management